



DMX

Pre-selected
range

Installation and
operating instructions
DMX 221



net.grundfos.com/qr/i/99558951

Installation and
operating instructions
DMX 226



net.grundfos.com/qr/i/99558952

be
think
innovate

GRUNDFOS 

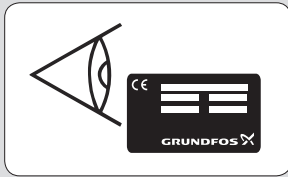

Min./Max.
0 °C / +40 °C
32 °F / 104 °F



Min./Max.
-10 °C / +45 °C
14 °F / 113 °F



≤ 55 dB(A)



IP 65



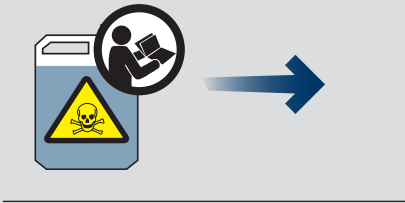
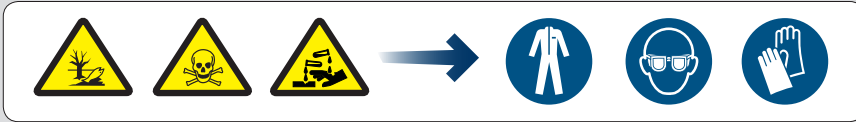



$p_2 < p_{max.} =$



p_2

$p_2 - p_1 \geq 1 \text{ bar (15 psi)}$



p_1





1

Min.
90 mm

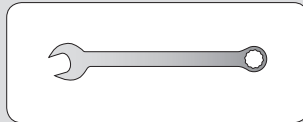
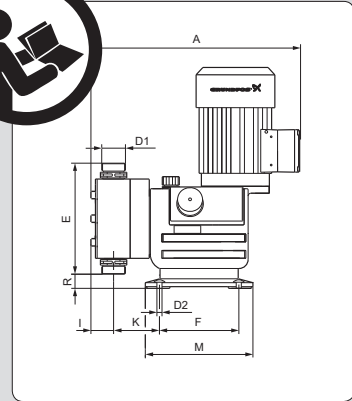

4 x

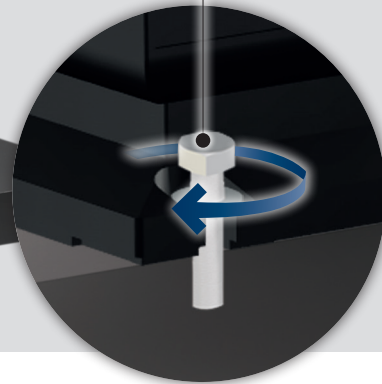

2

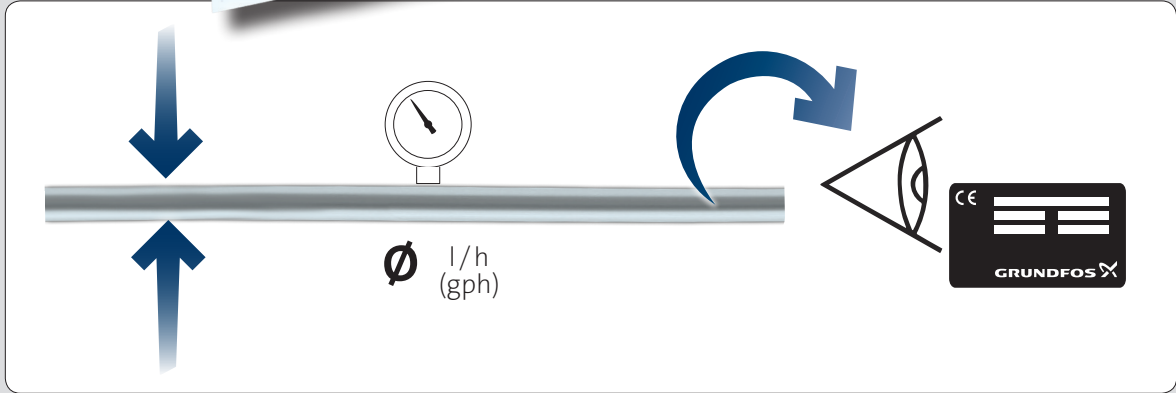
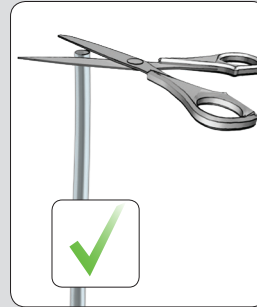
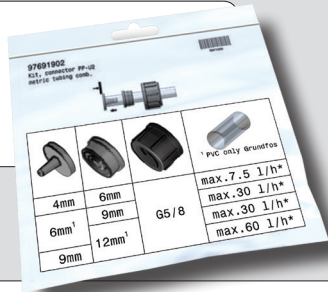
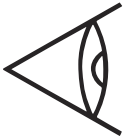



3a

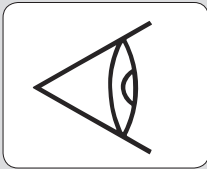

DN 8

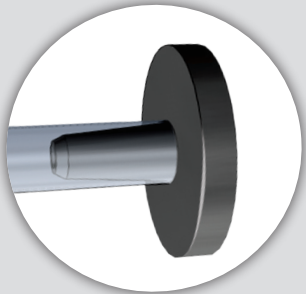
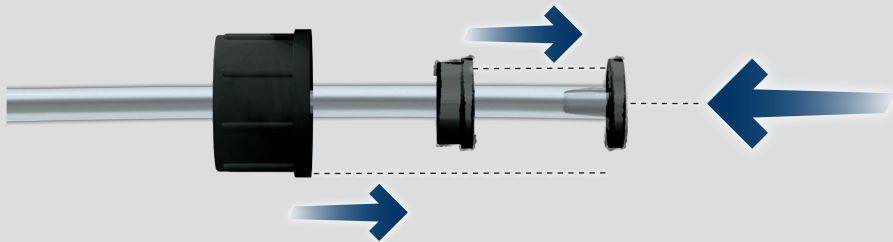

3b

DN 20

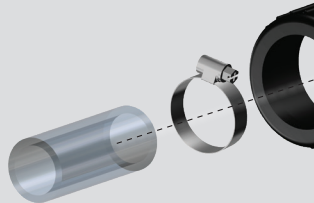

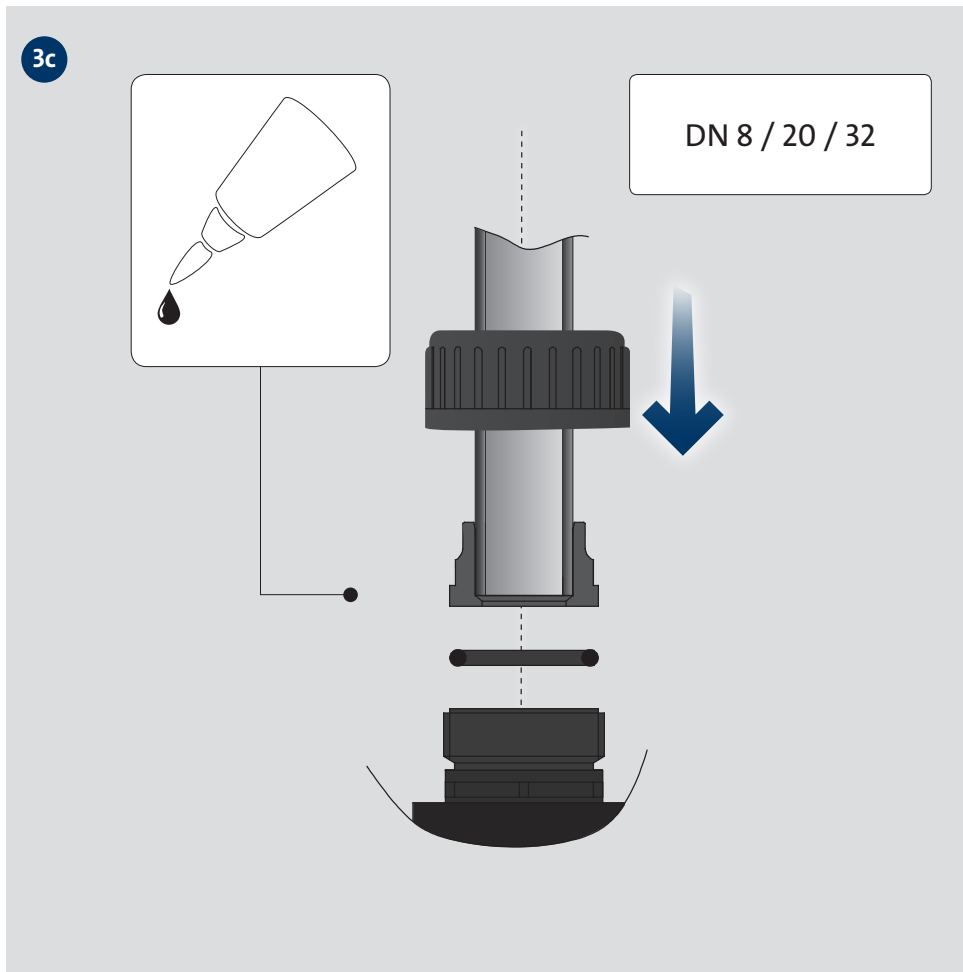



4

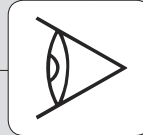
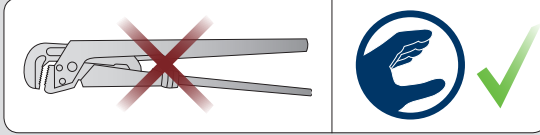

5

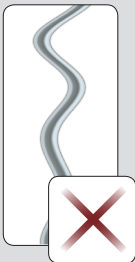
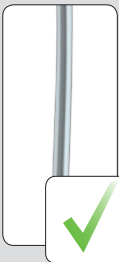
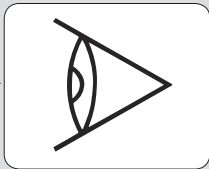



6a

DMX 221

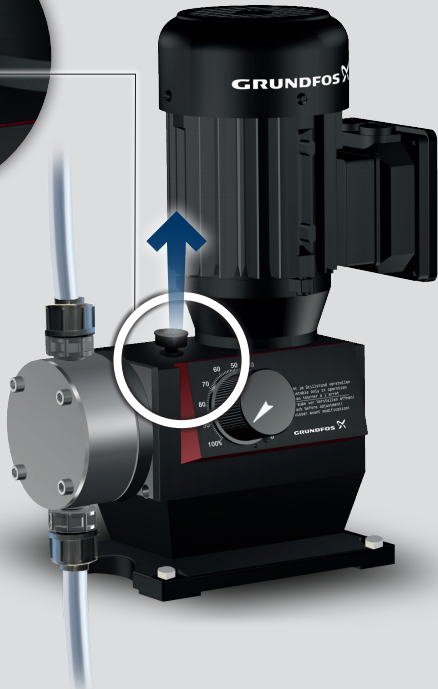
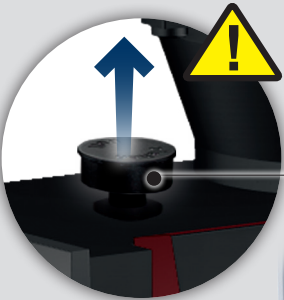

6b

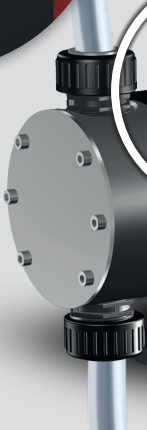
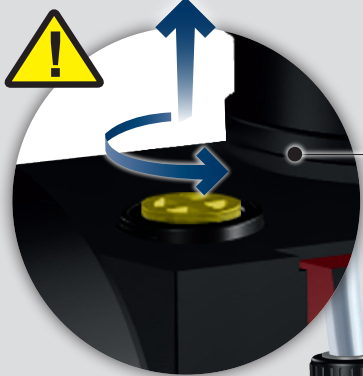
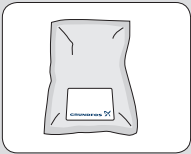

DMX 226

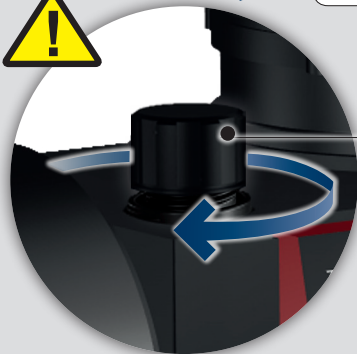

DMX 226





7

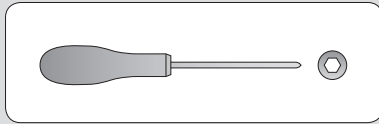

4 x

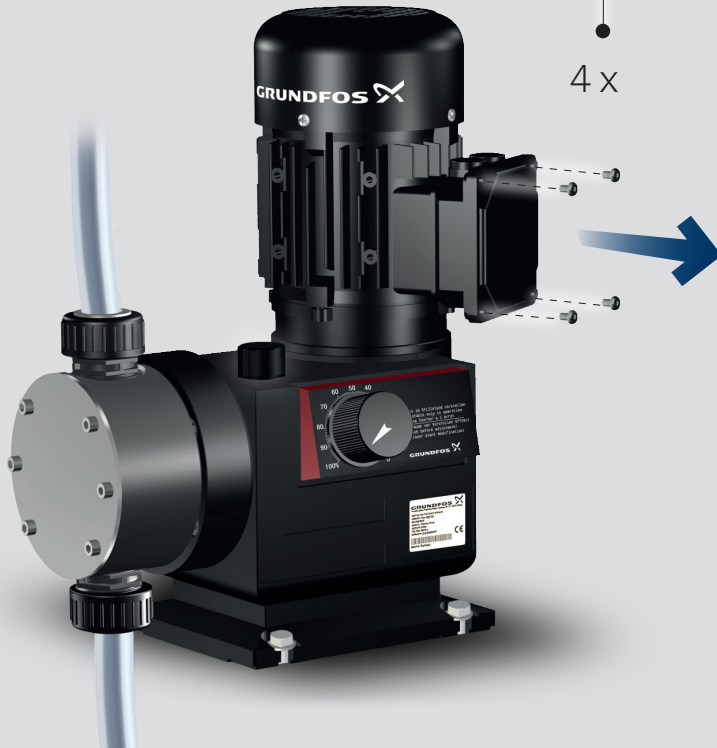

8



1AC 230V
50Hz ⚡

3AC 230/400V
50Hz ⚡



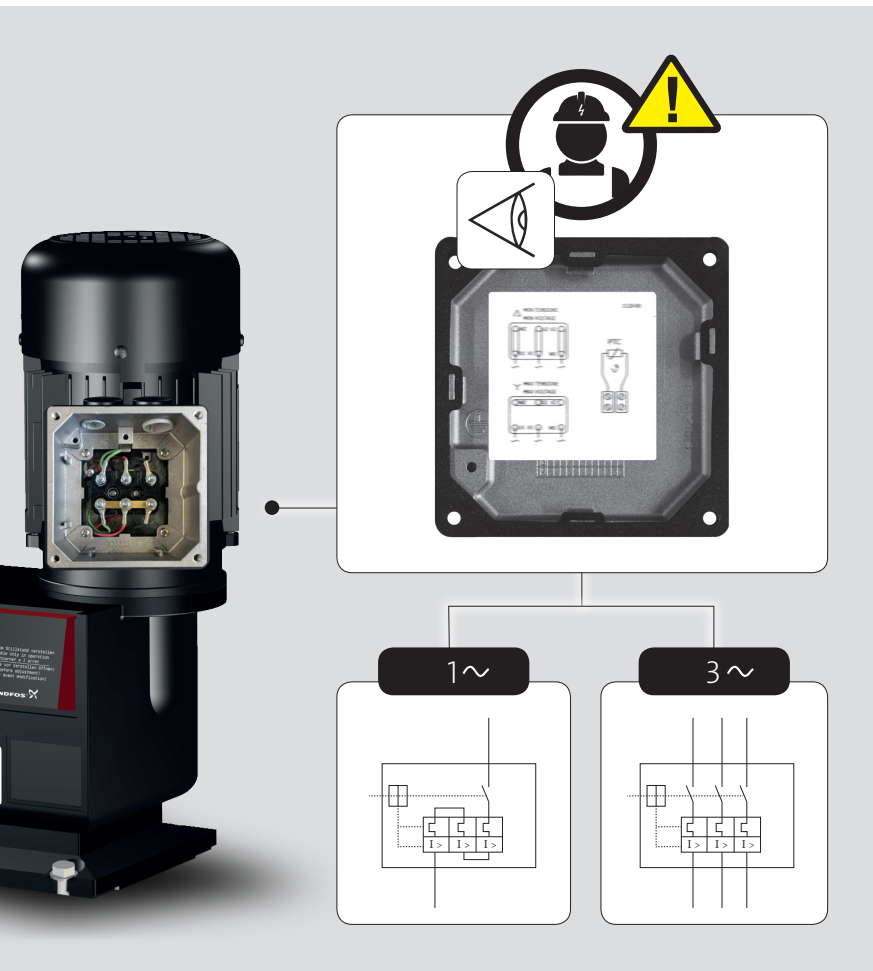



10

Installation
example

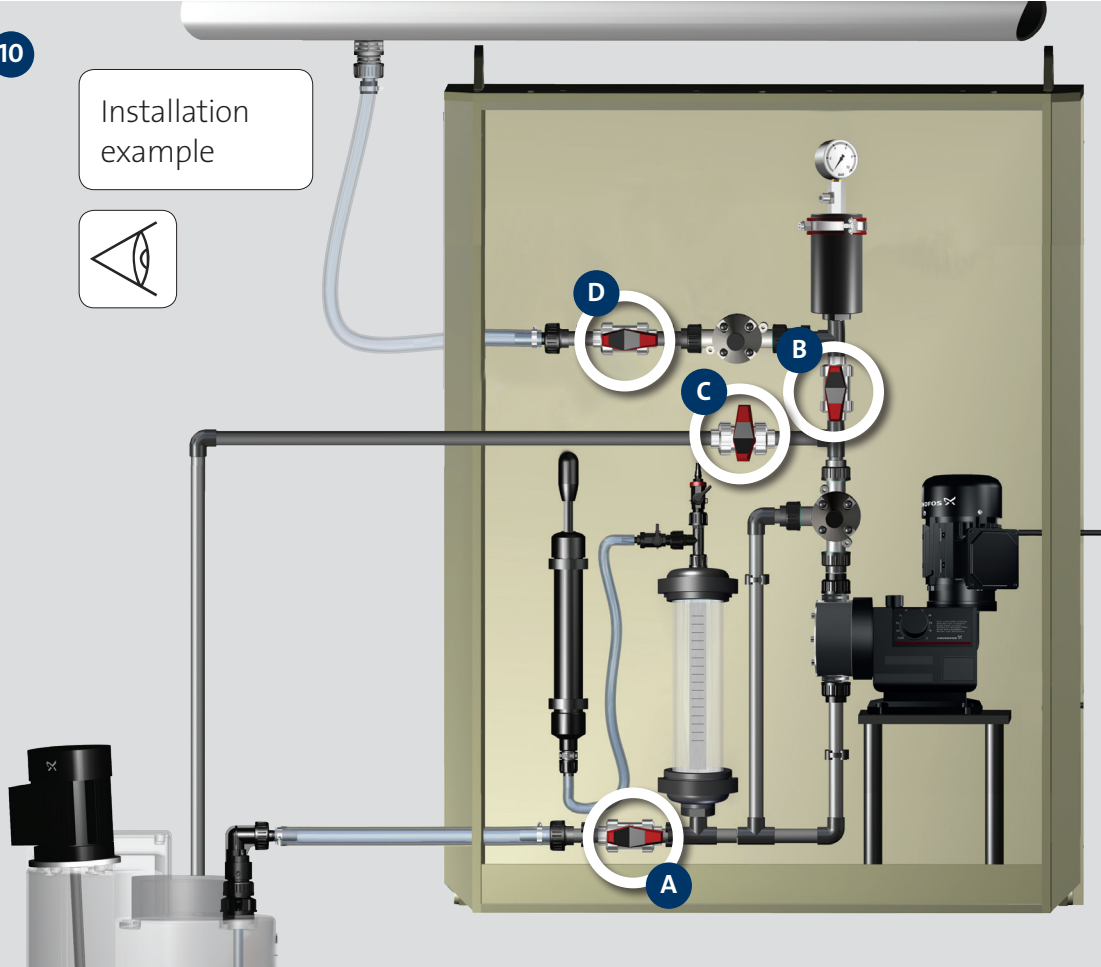

11



16



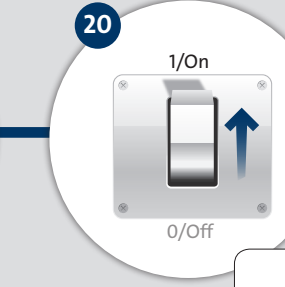
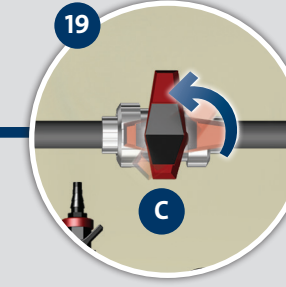
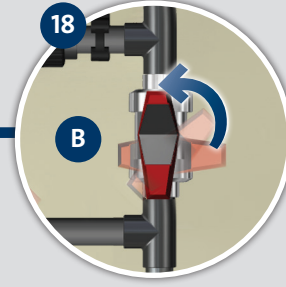
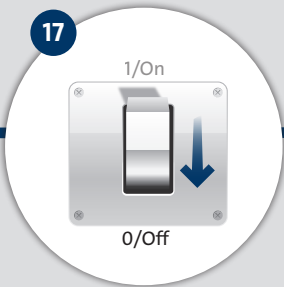
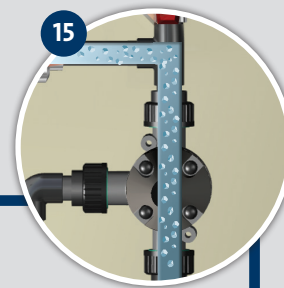
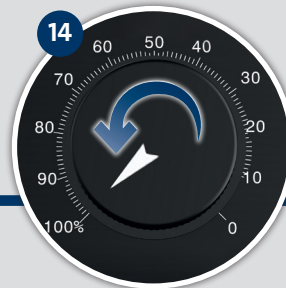
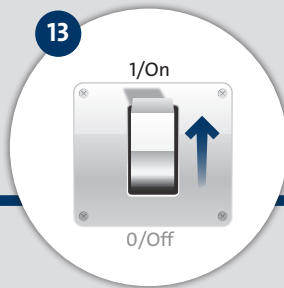
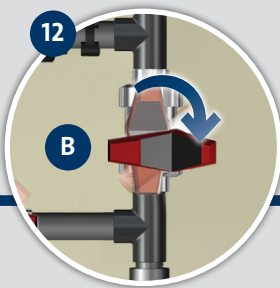
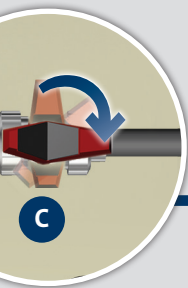



21

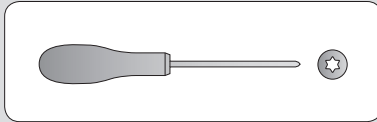

22

Nicht im Stillstand verstellen
Adjustable only in operation
Ne pas tourner à l'arrêt
Schraube vor Verstellen öffnen!
Unlock before adjustment!
Dévisser avant modification!

GRUNDFOS 

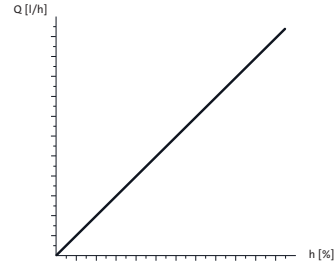

23

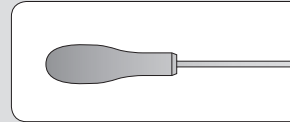



**6 - 10 h
operating
/ 2 days**

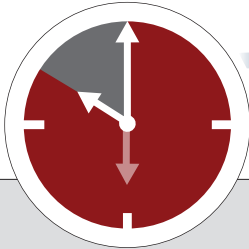

DMX
16-12, 27-12, 50-10:
6 - 8 Nm

All others:
5 - 6 Nm

4/6 x





- Daily



- Monthly

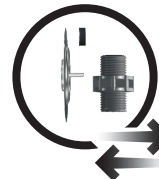

⌚ ≤ 10 bar (145 psi)

Every 4.000 h operating / 12 month

⌚ 10 - 16 bar (145 - 232 psi)

Every 2.000 h operating / 6 month



2

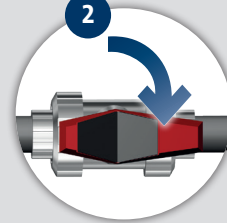

1

1/On



0/Off

0 bar (0 psi)



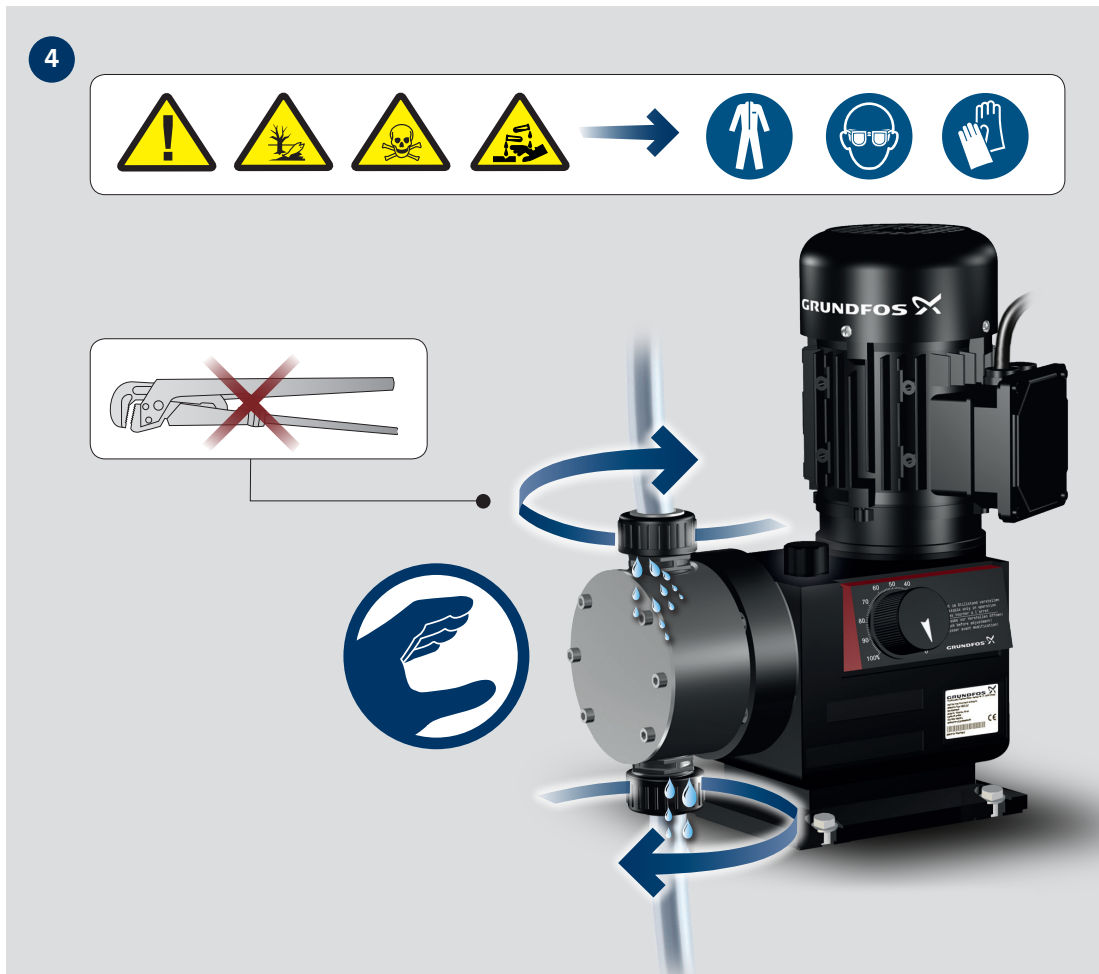

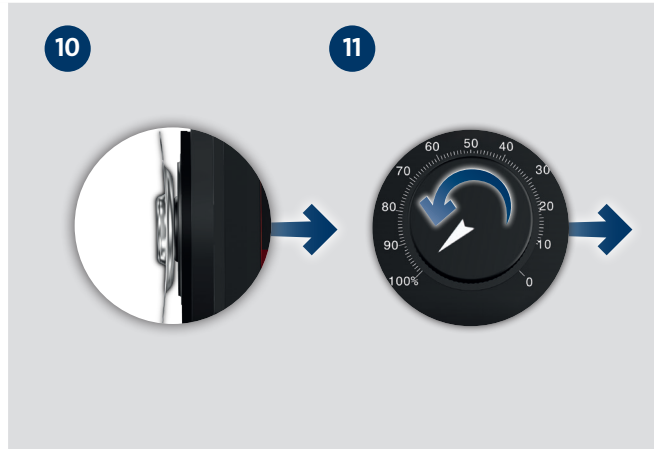
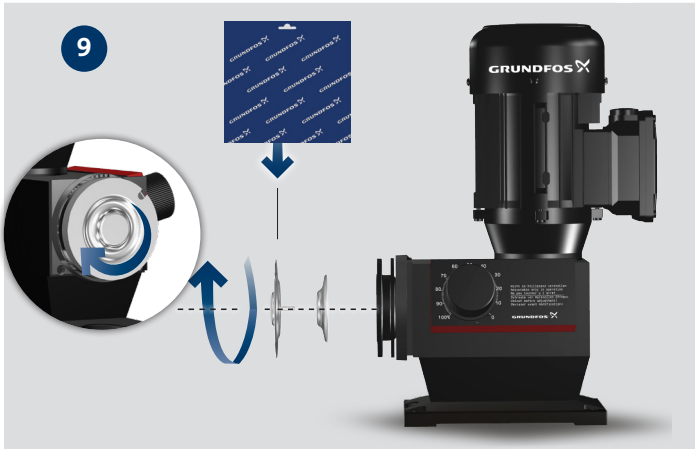
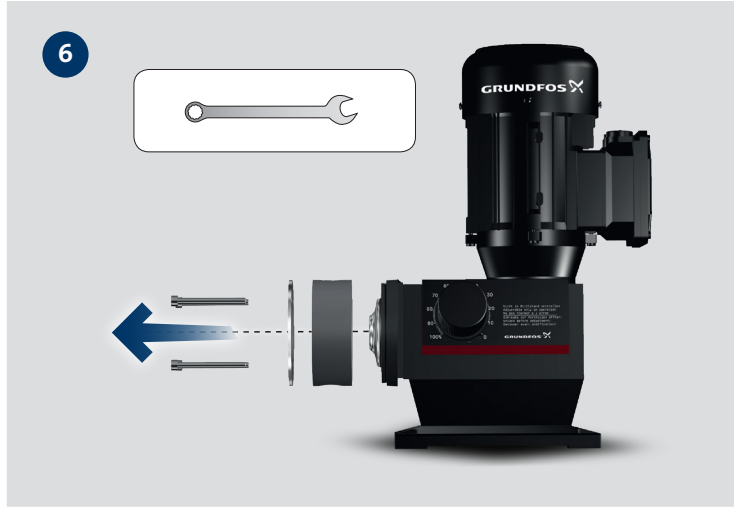
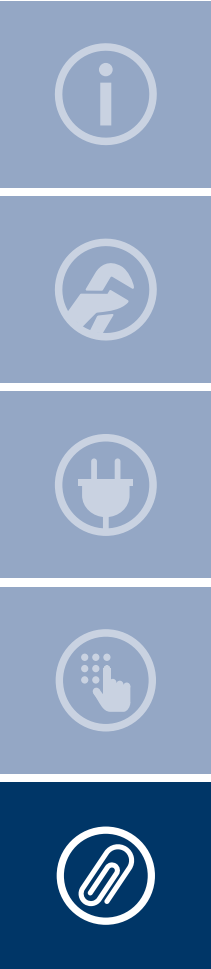

11

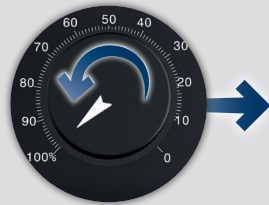

7

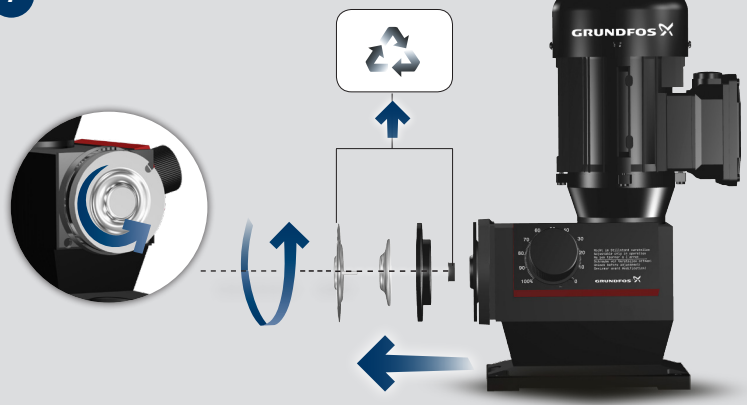

8

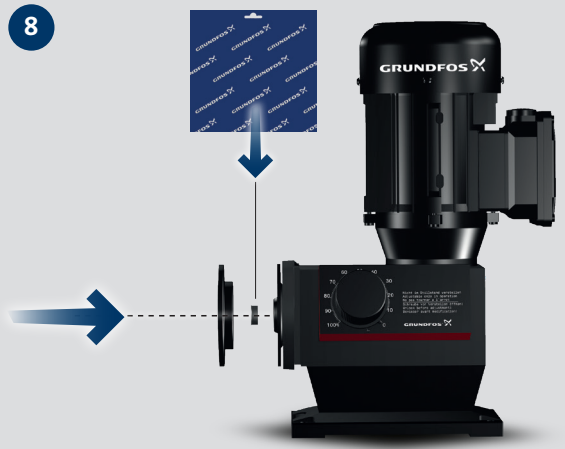

12

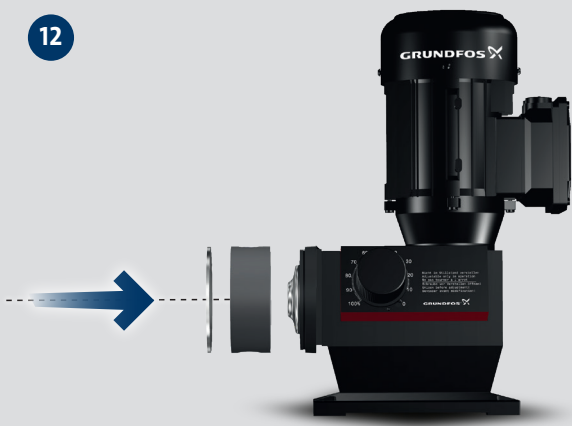



DMX
 16-12, 27-12, 50-10:
 6 - 8 Nm

All others:
 5 - 6 Nm

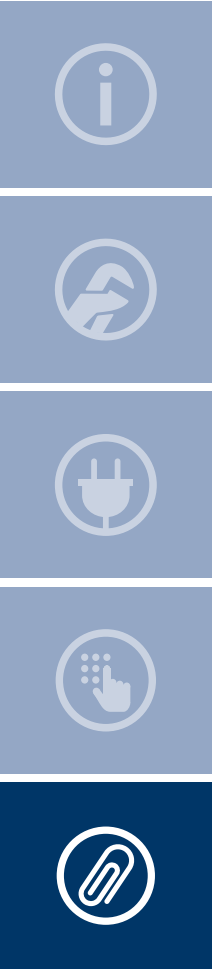

13



14

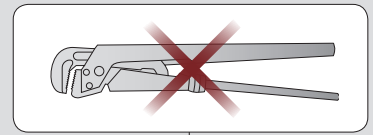



6 - 10 h
operating
/ 2 days

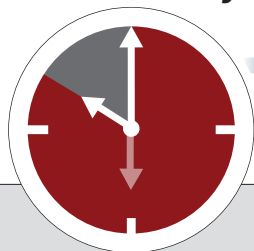

DMX
16-12, 27-12, 50-10:
6 - 8 Nm

All others:
5 - 6 Nm

4/6 x

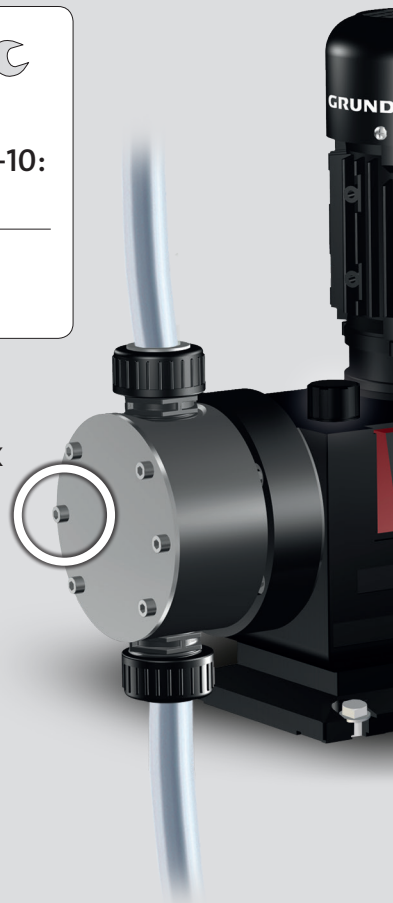



For service
and grease change,
send the pump to
Grundfos Service.

20.000 h
operating /
5 years

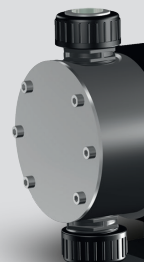
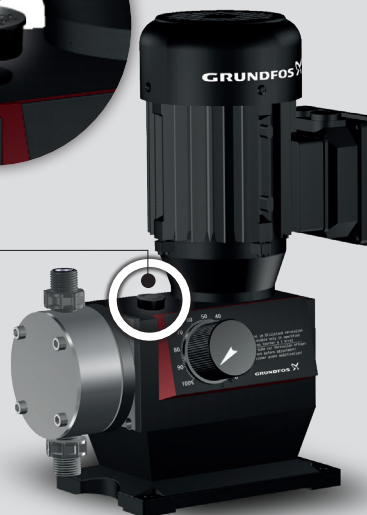
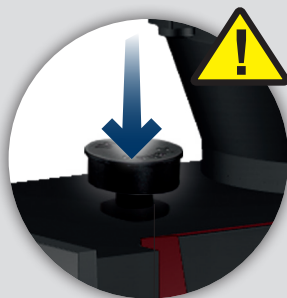
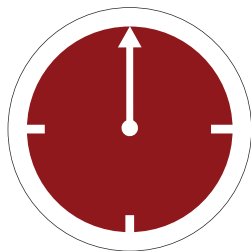



Declaration

This is to be filled in and kept with the pump and attached to the pump returned for service. The declaration must be filled in the original language.

Please indicate the damaged part of the technical or functional part. If several parts are damaged, please mark the cabinet with a short description of the fault.

Declaration
 I hereby declare that the product is free from hazardous chemicals, biological and radioactive materials.

Designation: _____
 Model: _____
 Serial number: _____
 Date and signature: _____
 Company stamp: _____

196

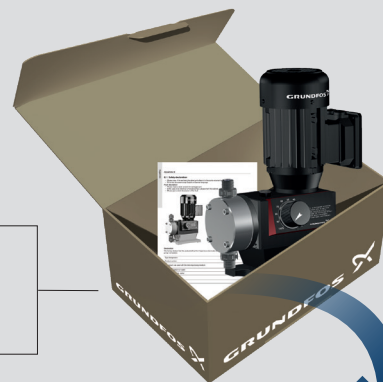
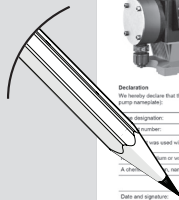

be think innovate

99153968 0320

ECM: 1280460

GRUNDFOS Holding A/S
Poul Due Jensens Vej 7
DK-8850 Bjerringbro
Tel: +45 87 50 14 00
www.grundfos.com

GRUNDFOS 

Trademarks displayed in this material, including but not limited to Grundfos, the Grundfos logo and "be think innovate" are registered trademarks owned by The Grundfos Group. All rights reserved.
© 2020 Grundfos Holding A/S, all rights reserved.