

# SPE

Regulated submersible pumps with PM motors

NAMREG

3600 rpm



|   |           |  |           |
|---|-----------|--|-----------|
| <b>1. General description</b> . . . . .                       | <b>3</b>  | SPE 230S . . . . .                                     | 36        |
| Pump Energy Index . . . . .                                   | 5         | SPE 300S . . . . .                                     | 39        |
| PEI index . . . . .   | 5         | SPE 385S . . . . .                                     | 42        |
| Type key . . . . .  | 6         | SPE 475S . . . . .                                     | 45        |
| Applications . . . . .  | 6         | SPE 625S . . . . .                                     | 48        |
| Pump range . . . . .  | 7         | SPE 800S . . . . .                                     | 51        |
| Motor range . . . . .   | 7         | SPE 1100S . . . . .                                    | 54        |
| <br>  |           |  |           |
| <b>2. Submersible pumps</b> . . . . .                         | <b>8</b>  | <b>8. Electrical data</b> . . . . .                    | <b>57</b> |
| Features and benefits . . . . .                               | 8         | 3 × 410 V 3600 rpm, MS6000P submersible motor          |           |
| Material specification (SPE 90S-SPE 300S) . . . . .           | 10        | T60 . . . . .  | 57        |
| Material specification (SPE 385S-SPE 1100S) . . . . .         | 11        |  |           |
| <br>  |           | <b>9. Electrical accessories</b> . . . . .             | <b>58</b> |
| <b>3. Submersible permanent magnet motors</b> . . . . .       | <b>12</b> | Accessories for CUE . . . . .                          | 58        |
| Features and benefits . . . . .                               | 12        | Grundfos Communication Interface Units (CIU) . . . . . | 58        |
| Shaft seal system . . . . .                                   | 14        | Pt100 and accessories . . . . .                        | 59        |
| Material specification MS6000P . . . . .                      | 15        |  |           |
| <br>  |           | <b>10. Mechanical accessories</b> . . . . .            | <b>60</b> |
| <b>4. Grundfos variable frequency drive for SPE</b> . . . . . | <b>16</b> | Connecting pieces / Adaptors . . . . .                 | 60        |
| CUE variable frequency drive . . . . .                        | 16        | Zinc anodes . . . . .                                  | 60        |
| Overview of the relevant CUE range for SPE . . . . .          | 16        | Flow sleeves . . . . .                                 | 61        |
| RFI filters . . . . .   | 16        |  |           |
| Functions . . . . .   | 16        | <b>11. Cable sizing</b> . . . . .                      | <b>62</b> |
| CUE features . . . . .  | 17        | Cable dimensions at 3 × 410 V, 120 Hz motor            |           |
| Sine-wave filter . . . . .                                    | 17        | supply, valid for AWG and MCM cables . . . . .         | 62        |
| Cables in CUE installations . . . . .                         | 18        |  |           |
| Using variable frequency drives of other brands . . . . .     | 20        | <b>12. Head loss</b> . . . . .                         | <b>64</b> |
| Data for 120 Hz / 3 × 410 V motor voltage . . . . .           | 20        | Friction loss tables . . . . .                         | 64        |
| Grundfos offerings, easy selection . . . . .                  | 20        |  |           |
| <br>  |           | <b>13. Grundfos Product Center</b> . . . . .           | <b>66</b> |
| <b>5. Selection and sizing</b> . . . . .                      | <b>21</b> |  |           |
| <br>  |           | <b>14. Document quality feedback</b> . . . . .         | <b>67</b> |
| <b>6. Operating conditions</b> . . . . .                      | <b>25</b> |  |           |
| Inlet pressure . . . . .                                      | 25        |  |           |
| Min. flow rate . . . . .                                      | 25        |  |           |
| Max. flow rate . . . . .                                      | 25        |  |           |
| Pumped liquids . . . . .                                      | 25        |  |           |
| Liquid temperature . . . . .                                  | 25        |  |           |
| Max. operating pressure . . . . .                             | 25        |  |           |
| Ramp times . . . . .  | 25        |  |           |
| Service . . . . .   | 26        |  |           |
| Start/stop . . . . .  | 26        |  |           |
| Sound pressure level . . . . .                                | 26        |  |           |
| Moment of inertia . . . . .                                   | 26        |  |           |
| Recommended minimum borehole diameter . . . . .               | 27        |  |           |
| How to read the curve charts . . . . .                        | 28        |  |           |
| Curve conditions . . . . .                                    | 29        |  |           |
| <br>  |           |  |           |
| <b>7. Performance curves and technical data</b> . . . . .     | <b>30</b> |  |           |
| SPE 90S . . . . .   | 30        |  |           |
| SPE 160S . . . . .  | 33        |  |           |

## 1. General description

SPE is a speed-controlled submersible pump system with a permanent magnet motor. It has a low running cost and can be used in changing operation conditions. The pump is suitable for a number of applications within groundwater pumping, for example the following:

- water supply
- irrigation
- groundwater lowering.

An all-stainless steel construction in three different material grades ensures that the pump can be used for both clean- as well as corrosive water.

The pump system consists of reliable hydraulics and an energy efficient Interior Permanent Magnet (IPM) motor. The magnets are embedded in the rotor. The magnets in MS6000P are further protected as the rotor is hermetically sealed with a thin layer of metal. The motor design furthermore consists of the following:

- canned stator design
- mechanical shaft seals with Silicon Carbide seal faces
- heavy duty thrust bearings.

The motor is running synchronous and needs a Variable Frequency Drive (VFD), such as the Grundfos CUE, to control the speed according to the requirements. The CUE includes a wizard to make the setup easy. The CUE has the following predefined control modes:

- constant pressure
- constant flow
- constant level.

The CUE also protects the pump installation, including minimizing the risk of water hammer and reducing stresses to the submersible motor during start by a soft starter function.

Performance range

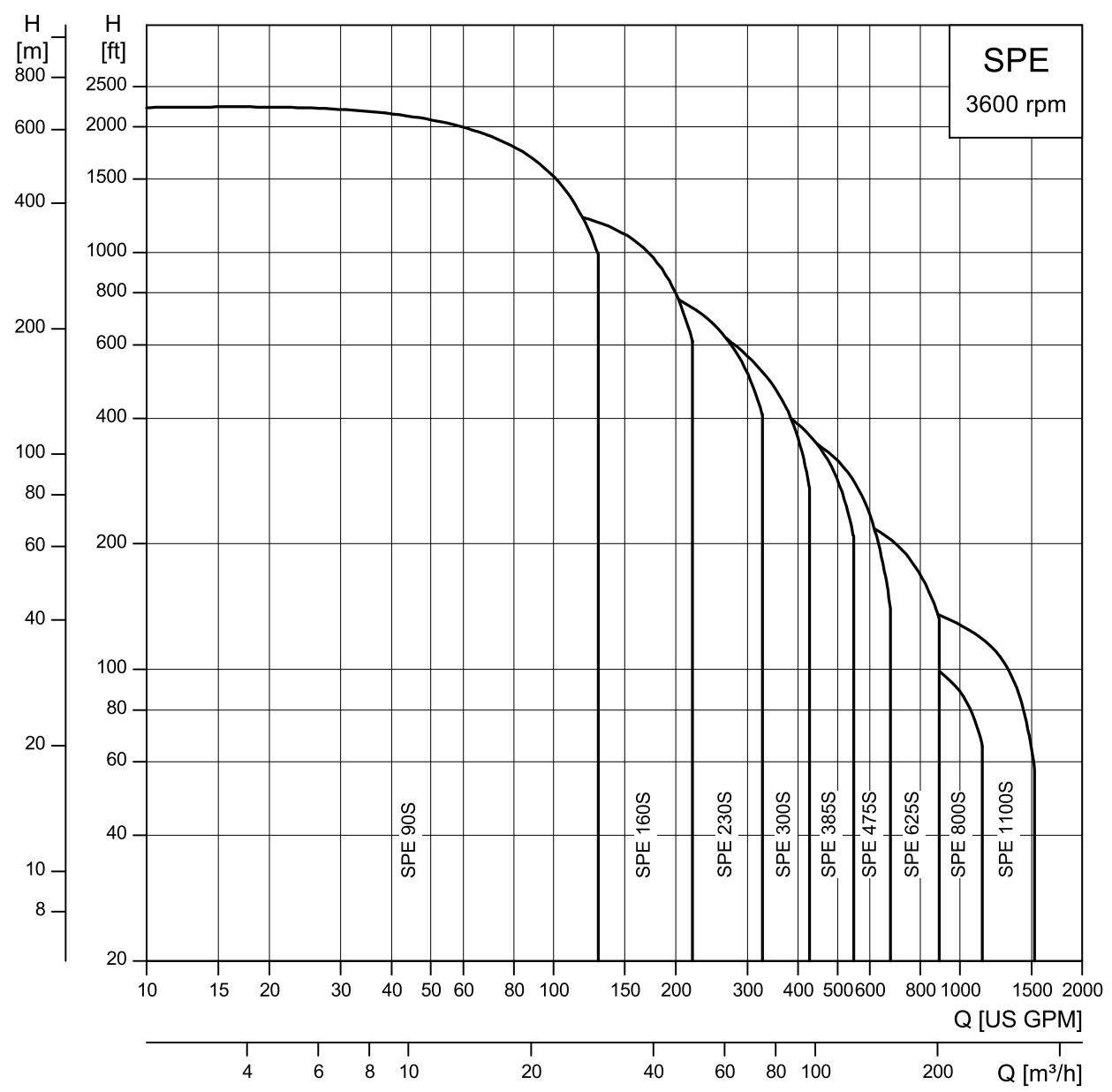

TM081252

## Pump Energy Index

Pump Energy Index (PEI) was established by the U.S. Department of Energy (DOE) and adopted by Canada as the standard metric used to evaluate pump efficiency. The value is the ratio of the pump efficiency rating (PER) divided by the calculated minimally compliant PER ( $PER_{STD}$ ) for the pump type. This provides a representation of the actual pump performance compared to the minimal standard performance required by regulation. The lower the PEI value, the more efficient a pump is at the tested operating points.

PER is determined by defined testing parameters required by the DOE. This includes testing a particular pump model at its best efficiency point (BEP).

For PEI values, there are two different versions:

- $PEI_{CL}$  (constant load): applies to a bare-shaft pump, and a pump sold with a motor
- $PEI_{VL}$  (variable load): applies to pumps sold with a motor and controller (such as VFD, VSD).

The DOE has set the maximum PEI value as 1.00. Any pump, pump and motor, or pump, motor and controller that exceeds a PEI value of 1.00 can no longer be manufactured after January 26, 2020.

PEI is a generalized efficiency value. PEI cannot be used to determine the efficiency of a pump in a specific application.

## PEI index

| Pump type | Pole | Motor size [hp] | $PEI_{CL}$ bare-shaft pump | $PEI_{CL}$ pump with motor | $PEI_{VL}$ pump with motor plus controller <sup>1)</sup> | Impeller diameter [in] |
|-----------|------|-----------------|----------------------------|----------------------------|--|------------------------|
| 90S       | 4    | 10              | 0.82                       | 0.85                       | 0.33   | 3.49                   |
|           |      | 25              |                            |                            | 0.32   |                        |
| 160S      |      | 10              | 0.91                       | 0.91                       | 0.35   | 3.52                   |
|           |      | 25              |                            |                            | 0.35   |                        |
| 230S      |      | 10              | 0.92                       | 0.92                       | 0.37   | 3.87                   |
|           |      | 25              |                            |                            | 0.36   |                        |
|           | 40   | 0.36            |                            |                            |  |                        |
| 300S      | 10   | 0.92            | 0.92                       | 0.37                       | 3.90   |                        |
|           | 25   |                 |                            | 0.36                       |  |                        |
|           | 40   |                 |                            | 0.37                       |  |                        |

<sup>1)</sup> Grundfos continuous controls.

## Type key

| Example | SPE                               | 475 | S                                      | 500 | 5 | PD |
|---------|-----------------------------------|-----|--|-----|---|----|
| Pos.    | 1                                 | 2   | 3                                      | 4   | 5 | 6  |
| Pos.    | Description                       |     |  |     |   |    |
| 1       | Pump type                         |     |  |     |   |    |
|         | - or SP                           | =   | Standard design                        |     |   |    |
|         | SPE                               | =   | ECM-design (MS6000P)                   |     |   |    |
| 2       | Rated flow rate in gpm            |     |  |     |   |    |
| 3       | Material version                  |     |  |     |   |    |
|         | Stainless steel parts of material |     |  |     |   |    |
|         | S                                 | =   | AISI 304 (EN 1.4301) SS                |     |   |    |
|         | N                                 | =   | AISI 316 (EN 1.4401) SS                |     |   |    |
|         | R                                 | =   | AISI 904L (EN 1.4539) SS               |     |   |    |
| 4       | Hp of motor                       |     |  |     |   |    |
| 5       | Number of impellers               |     |  |     |   |    |
|         | BP                                | =   | Bare Pump                              |     |   |    |
|         | -                                 | =   | Pump and motor (Standard or ECM motor) |     |   |    |
| 6       | CUE                               | -   | Standard motor and VFD                 |     |   |    |
|         | PD                                | -   | ECM motor and VFD (SPE only)           |     |   |    |

## Applications

SPE pumps are developed for pumping ground water from boreholes. The pumps are installed in boreholes or wells, submerged below the water level.

For industrial purposes, the pump can be placed for example, in a tank.

The pumps are suitable for the following applications:

- raw-water supply
- irrigation
- groundwater lowering
- pressure boosting
- fountain applications
- mining applications
- offshore applications.

## Pump range

| Type      | Steel<br>AISI 304 | Steel<br>(N) AISI 316 | Steel<br>(R) AISI 904L | Connection<br>NPT |
|-----------|-------------------|-----------------------|------------------------|-------------------|
| SPE 90S   | •                 | •                     | •                      | 3"                |
| SPE 160S  | •                 | •                     | •                      | 3"                |
| SPE 230S  | •                 | •                     | •                      | 3"                |
| SPE 300S  | •                 | •                     | •                      | 3" 4"             |
| SPE 385S  | •                 | •                     | •                      | 4"                |
| SPE 475S  | •                 | •                     | •                      | 6"                |
| SPE 625S  | •                 | •                     | •                      | 6"                |
| SPE 800S  | •                 | •                     | •                      | 6"                |
| SPE 1100S | •                 | •                     | •                      | 6"                |

## Motor range

MS6000P covers several standard motor outputs.

|                      |     |     |    |    |    |    |    |    |    |
|----------------------|-----|-----|----|----|----|----|----|----|----|
| Motor execution [hp] |     | 10  |    |    | 25 |    | 40 | 50 |    |
| Motor output [hp]    | 5.0 | 7.5 | 10 | 15 | 20 | 25 | 30 | 40 | 50 |

## 2. Submersible pumps

### Features and benefits

#### A wide pump range

Grundfos offers energy-efficient, submersible SPE pumps ranging from 45 to 1585 GPM. The pump range consists of various pump sizes from SPE 85S to SPE 1100S. Each pump size is available with an optional number of stages to match a given duty point.

#### High pump efficiency

Pump efficiency is often a neglected factor compared to the price. However, it is important to note that price variations are without importance to water supply economics compared to pump and motor efficiencies.

#### Example

If pumping 300 GPM at 330 ft head for 10 years, a normal pump set consumes approximately 2,775,000 kWh. By changing to an SPE high efficiency pump set, the increased efficiency results in a reduction of 274,200 kWh, corresponding to more than \$ 27,420 cost saving at a price of 0.10 \$ / kWh. In variable demand conditions, the saving is even higher.

#### Material and pumped liquids

To ensure the right wear resistance and reduce the risk of corrosion, the pump ranges are available with the following steel variants:

- **SPE:** AISI 304
- **SPE N:** AISI 316
- **SPE R:** AISI 904L.

See specified material variants in Pump range.

For further protection in corrosive environments, a complete range of zinc anodes for cathodic protection is available. See Zinc anodes.

#### Rubber components

For pumping liquids with a risk of chemical residue or above 140 °F (60 °C), all pumps can be supplied with rubber components made of FKM elastomer.

#### Low installation costs

Stainless steel sheet metal ensures low weight. This facilitates the handling of pumps and results in low equipment costs, reduced installation and service time.

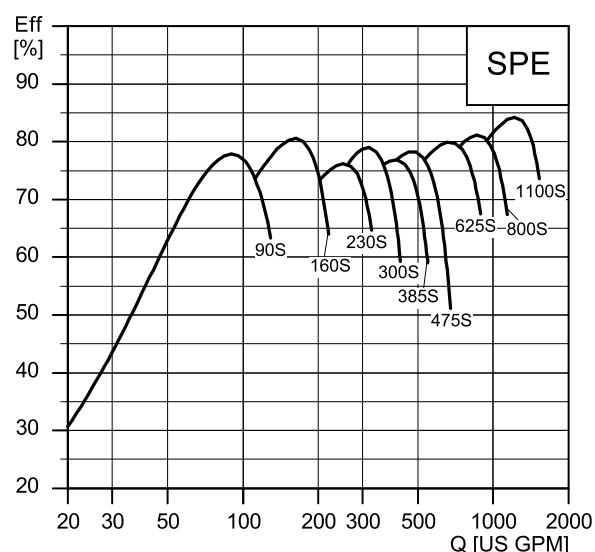

TM081253

Pump efficiencies in relation to flow



TM081065

Various SPE pumps



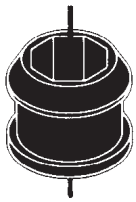

TM007301

**Bearings with sand channels**

All bearings are water-lubricated and have an octagonal shape enabling sand particles to leave the pump together with the pumped liquid. The use of LSR ensures increased wear resistance, allowing a high limit for particles in the pumped liquid. LSR is used as standard in pumps ranging up to SPE 300S. On SPE 385S and larger pumps, the bearing material is NBR.

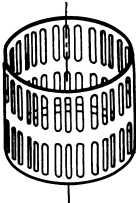
*Bearing*

TM007302

**Inlet strainer**

The inlet strainer prevents particles over a certain size from entering the pump. The hole size is 0.16 × 0.79 in.

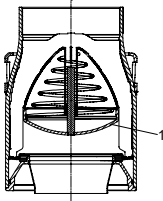
*Inlet strainer*

TM0124991

**Non-return valve**

All pumps have a non-return valve in the valve casing preventing backflow when the pump is stopped. Due to the short closing time of the non-return valve, the risk of water hammer is reduced to a minimum. The valve casing is designed to have optimum hydraulic properties to minimize the pressure loss across the valve and to contribute to high efficiency.

*Non-return valve*

Pos. 1 - Valve flap

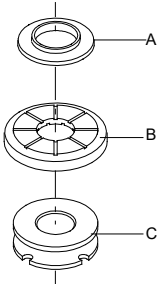

TM013327

**Stop ring**

The stop ring prevents damage to the pump during transportation and in case of upthrust during pump startup. The stop ring, which is designed as a thrust bearing, limits the axial movements of the pump shaft. The stationary part of the stop ring (A) is secured in the upper chamber. The rotating part (B) is fitted above the split cone (C).

*Stop ring (rotating and stationary parts).***Pump functioning as a turbine**

In case of unintended flow of water through a non-energized pump, there is a risk that the moving parts of the pump and the motor start rotating, thereby generating voltage over the terminals. The size of the voltage depends on the rotation speed. So the motor terminals must be considered as live until proven otherwise.

## Material specification (SPE 90S-SPE 300S)

| Pos. | Component               | Material                                | Standard N-version R-version |         |         |
|------|-------------------------|---|------------------------------|---------|---------|
|      |                         |   | AISI                         |         |         |
| 1    | Valve casing            | Stainless steel                         | 304                          | 316     | 904L    |
| 2    | Valve cup               | Stainless steel                         | 316                          | 316     | 904L    |
|      | Valve seat              | NBR-FKM                                 | NBR-FKM                      | NBR-FKM | NBR-FKM |
| 7    | Neck ring               | NBR-FKM                                 | NBR-FKM                      | NBR-FKM | NBR-FKM |
| 8    | Bearing                 | FKM-LSR                                 | FKM-LSR                      | FKM-LSR | FKM-LSR |
| 8a   | Washer for stop ring    | Carbon/graphite<br>HY22 in PTFE<br>mass |                              |         |         |
| 9    | Chamber                 | Stainless steel                         | 304                          | 316     | 904L    |
| 13   | Impeller                | Stainless steel                         | 304                          | 316     | 904L    |
| 14   | Suction interconnect or | Cast stainless steel                    | 304                          | 316     | 904L    |
|      | Strainer                | Stainless steel                         | 304                          | 316     | 904L    |
| 16   | Shaft complete          | Stainless steel                         | 431                          | 329     | 904L    |
| 17   | Strap                   | Stainless steel                         | 304                          | 316     | 904L    |
| 18   | Cable guard             | Stainless steel                         | 304                          | 316     | 904L    |

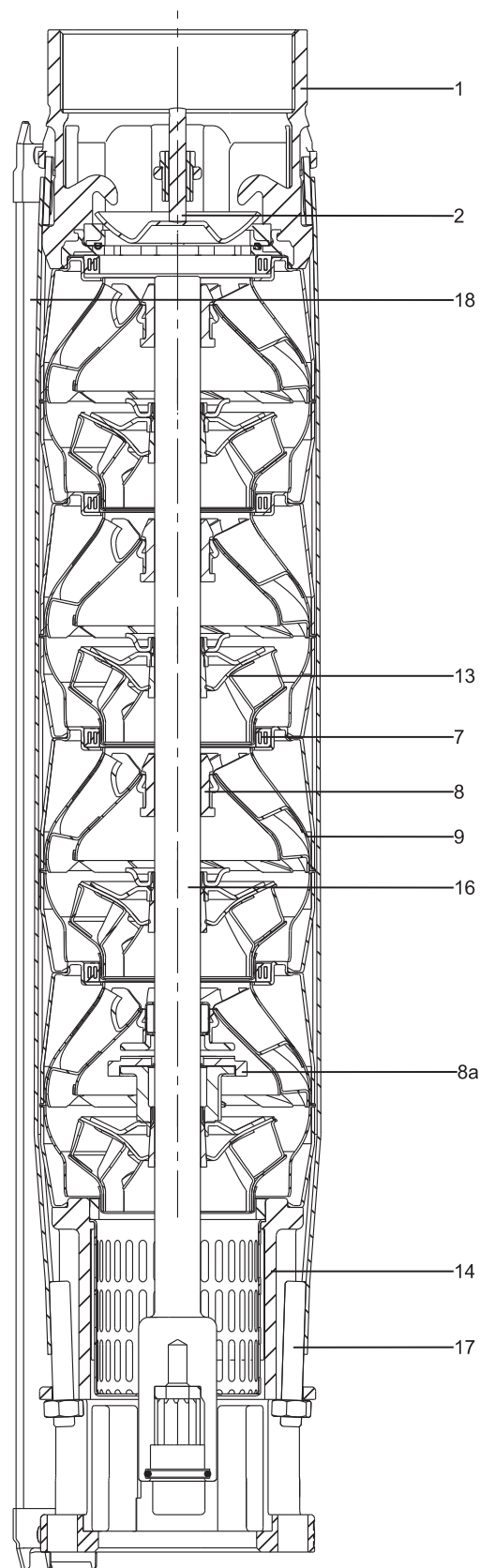

Example SPE 230S

TM06 1521

## Material specification (SPE 385S-SPE 1100S)

| Pos. | Component               | Material                                | Standard | N-version | R-version |
|------|-------------------------|---|----------|-----------|-----------|
|      |                         |   | AISI     |           |           |
| 1    | Valve casing            | Stainless steel                         | 304      | 316       | 904L      |
| 2    | Valve cup               | Stainless steel                         | 304      | 316       | 904L      |
|      | Valve seat              | NBR-FKM                                 | NBR-FKM  | NBR-FKM   | NBR-FKM   |
| 7    | Neck ring               | NBR-FKM                                 | NBR-FKM  | NBR-FKM   | NBR-FKM   |
| 8    | Bearing                 | NBR-FKM                                 | NBR-FKM  | NBR-FKM   | NBR-FKM   |
|      | Washer for stop ring    | Carbon/graphite<br>HY22 in PTFE<br>mass |          |           |           |
| 9    | Chamber                 | Stainless steel                         | 304      | 316       | 904L      |
| 13   | Impeller                | Stainless steel                         | 304      | 316       | 904L      |
| 14   | Suction interconnect or | Cast stainless steel                    | 304      | 316       | 904L      |
|      | Strainer                | Stainless steel                         | 304      | 316       | 904L      |
| 16   | Shaft complete          | Stainless steel                         | 431      | 329       | 904L      |
| 17   | Strap                   | Stainless steel                         | 304      | 316       | 904L      |
| 18   | Cable guard             | Stainless steel                         | 304      | 316       | 904L      |

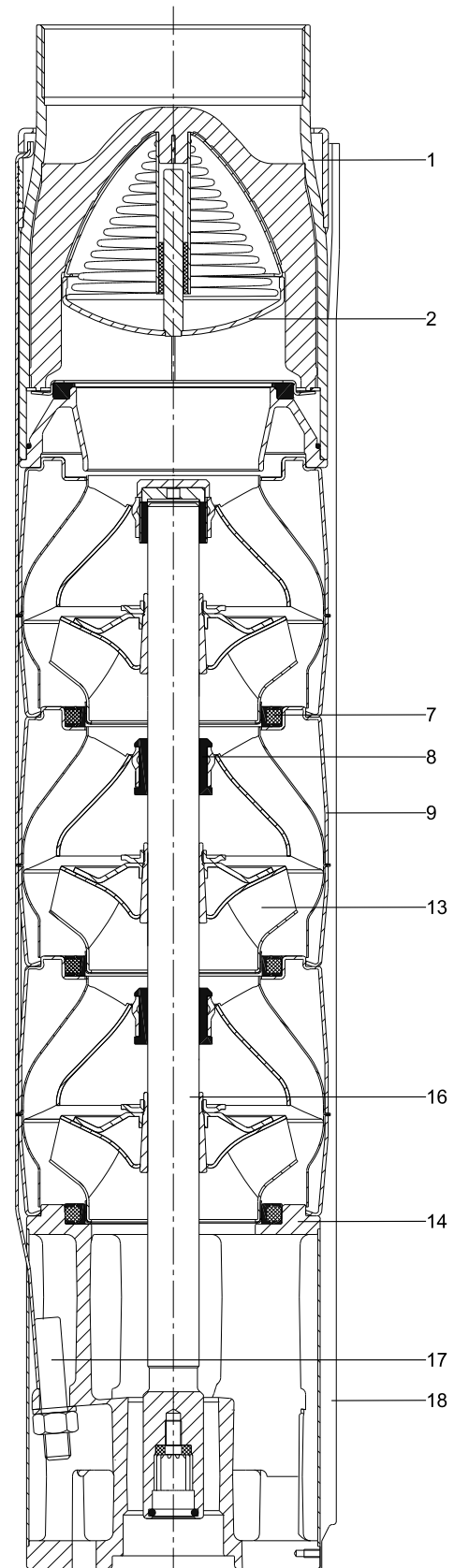

TM061192

Example SPE 385S

### 3. Submersible permanent magnet motors

For further information about Grundfos MS6000P submersible motors, see the MS motor literature available in Grundfos Product Center at <https://product-selection.grundfos.com>.

#### Features and benefits

Grundfos offers a complete range of 6 inch submersible motors of Interior Permanent Magnet (IPM), named MS6000P. These are based on the Grundfos MS6000 motor platform including the mechanical construction, thrust bearings with high thrust capability and shaft seals. The permanent magnet motor is a 4-pole synchronous motor. It requires a variable frequency drive as it cannot be directly connected to the electricity grid, contrary to the asynchronous motor.

The MS6000P permanent magnet motor offers the following advantages:

- 8-10 % higher efficiency compared to an asynchronous motor with the same output power.
- More compact design due to the high energy density of the permanent magnets, offering a lighter motor with a higher output.
- Reduced internal temperature in the motor due to the high efficiency.
- Strong permanent magnets. The Grundfos 6 inch version is based on 20 years of operating experience with a similar design.

The MS6000P is available in T60 version only. This means that the motor is able to operate in applications up to 140 °F as long as a standard cooling flow of 0.5 feet/s is ensured. In most applications, the media temperature is less than 140 °F and the surplus temperature capacity ensures an even more robust motor.

For particularly demanding applications in corrosive media, MS6000P is available in stainless steel quality AISI 904L, R version. Typical applications are the following:

- mining dewatering
- fish farming
- offshore industrial applications.



MS6000P motors

TM081248

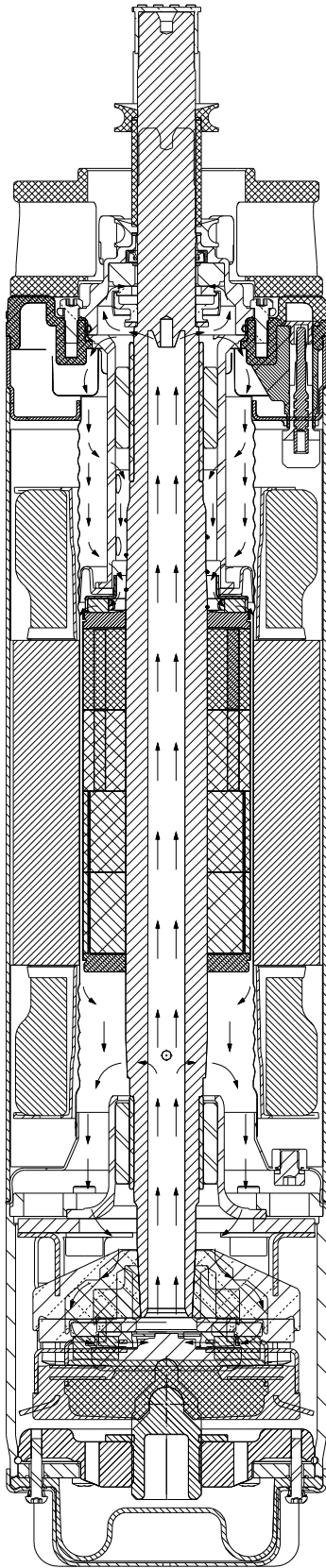

MS6000P lubrication flow

TM082006

### Stator

Grundfos MS6000P consists of a hermetically sealed stator withstanding external pressure up to 870 psi. It is a 4-pole construction with insulation class F winding material. All surfaces in contact with the pump media are made of stainless steel. The following material grades are available:

- AISI 304 for non-demanding installations (approved for drinking water).
- AISI 904L for installations with high chloride content. The stator is filled with an epoxy filler and wound for high robustness using grade two, overcoated enamel winding wire.

### Shaft and rotor

The NEMA splined shaft extension is friction welded to a stainless steel shaft. The stainless steel radial bearing bushes on the shaft form the rotating part of the radial bearings. The stationary part of the radial bearing is a carbon or graphite bush. The rotor pack consists of indexed segments with integrated (buried) rare earth magnets placed as a 4-pole construction. This makes the motor an IPM type. The rotor pack is hermetically sealed by a metal cladding welded onto the shaft. This ensures a long life time and prevents corrosion of the magnets. The bottom of the shaft has the rotating part of the thrust bearing mounted and the entire shaft is gun drilled to ensure lubrication of the mechanical shaft seal and the radial bearings. Due to the use of permanent magnets, heat is not generated in the rotor pack and subsequently the temperature rise in the motor liquid decreases drastically. This benefits the life time of the construction and ensures more a robust lubrication film in the radial and thrust bearing.

### Thrust bearing

Grundfos MS6000P uses identical thrust bearing to the MS6000 series consisting of a ceramic rotating disc running against tilting pads and carbon or graphite shoes on the stationary part.

## Shaft seal system

Grundfos MS6000P has a rubber sand slinger covering the top of a stainless steel shaft sealing house. When the shaft starts rotating, settled sand is removed from the shaft seal area due to the centrifugal force.

Inside the shaft seal house, a lip seal is placed above a mechanical shaft seal with SIC/SIC faces placed in NBR rubber elastomers. The shaft seal construction enables drinking water approval of the finished product.

The shaft seal is according to EN 12756.

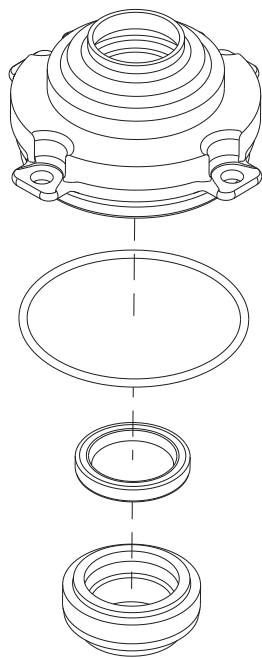

TM076025

*Shaft seal, MS6000P*

### Lightning protection

Use extra lightning protection or surge arrester for the electrical panels in relation to the SPE system.

## Material specification MS6000P

### Standard version motor

| Pos. | Component        | Material               |
|------|------------------|------------------------|
| 1    | Shaft            | AISI 431               |
| 2    | Shaft seal       | SiC/SiC                |
|      | Rubber type      | NBR                    |
| 3    | Motor sleeve     | AISI 304               |
| 4    | Motor end shield | AISI 304               |
|      | Diaphragm        | NBR                    |
| 5    | Radial bearing   | Carbon/stainless steel |
| 6    | Axial bearing    | Ceramic/carbon         |

### R-version motor

| Pos. | Component        | Material               |
|------|------------------|------------------------|
| 1    | Shaft            | AISI 904L              |
| 2    | Shaft seal       | SiC/SiC                |
|      | Rubber type      | FKM                    |
| 3    | Motor sleeve     | AISI 904L              |
| 4    | Motor end shield | AISI 904L              |
|      | Diaphragm        | FKM                    |
| 5    | Radial bearing   | Carbon/stainless steel |
| 6    | Thrust bearing   | Ceramic/carbon         |

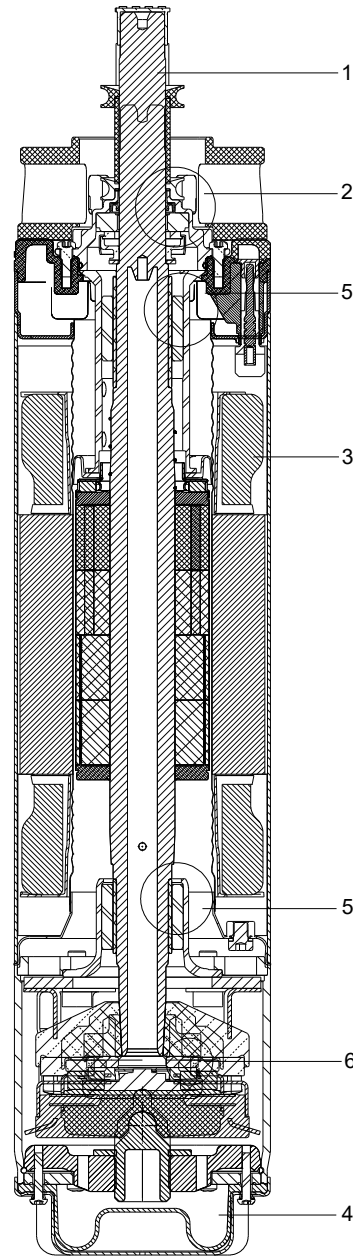

MS6000P

TM082013

## 4. Grundfos variable frequency drive for SPE

To operate the SPE pump, a variable frequency drive is required. Grundfos offers the CUE for this purpose.

For use in solar application, Grundfos an RSI is recommended. For further information about Grundfos RSI and Solar, see the literature available in Grundfos Product Center at <https://product-selection.grundfos.com>.

### CUE variable frequency drive



The CUE range

Grundfos CUE is a series of external variable frequency drives designed for speed control of a wide range of Grundfos pumps, including SPE.

When a CUE is installed, the motor does not require further overload protection.

Pt100 or Pt1000 together with MCB 114 sensor input module can provide overheating protection of the motor windings, if needed.

CUE offers quick and easy setup and commissioning compared to a standard variable frequency drive as the startup guide is designed specifically for Grundfos pumps, including SPE.

### Overview of the relevant CUE range for SPE

| Supply voltage [V] | Power range [hp] |    |    |    |     |
|--------------------|------------------|----|----|----|-----|
|                    | 5                | 10 | 15 | 60 | 100 |
| 3 × 380-500        | •                | •  | •  | •  | •   |
| 3 × 525-600        | •                | •  |    |    |     |
| 3 × 525-690        |                  |    | •  | •  | •   |

CUE is available in the following enclosure classes:

- NEMA 1
- NEMA 12.

### RFI filters

To meet the EMC requirements, CUE comes with the following types of built-in radio frequency interference filters (RFI).

| Voltage [V] | Typical shaft power, P2 [hp] | RFI filter type | Application |
|-------------|------------------------------|-----------------|-------------|
| 3 × 380-500 | 5-120                        | C1              | Domestic    |
| 3 × 525-600 | 5-10                         | C3              | Industry    |
| 3 × 525-690 | 15-35                        | C3              |             |

### Functions

CUE has a wide range of pump-specific functions. For groundwater applications, the following are especially relevant:

- constant pressure
- constant level
- constant flow rate.

TM076113



## CUE features

- startup guide
- easy setup
- check of the direction of rotation
- duty and standby operation
- dry-running protection
- low-flow stop function.

The CUE startup guide is automatically activated at the first startup. Here, a number of parameters are set automatically based on the pump type. Other parameters are set manually based on the data indicated on the motor and pump nameplates. The startup guide can be repeated, if necessary.

Due to the startup guide, the installer can quickly set central parameters and put CUE into operation.

### Sensors

The following sensors can be used in connection with CUE:

- pressure sensors, up to 25 bar
- temperature sensors
- differential-pressure sensors
- differential-temperature sensors
- flowmeters
- potentiometer box for external setpoint setting.

All sensors are with 4-20 mA output signal.

## Sine-wave filter

The use of IPM-ready sine-wave filters is required on SPE pumps.

The purpose of the output filters is the following:

- protect the motor from overvoltage and increased operating temperature.
- reduce voltage stress on the motor windings and stress on the motor insulation system.
- decrease acoustic noise from the motor that is driven by a variable frequency drive.

Sine-wave filters have a particularly high degree of filtering, resulting in high reduction of motor insulation stress and elimination of switching acoustic noise from the motor. The motor losses are reduced as the motor is fed with a sine-wave voltage and the filter eliminates the pulse reflections in the motor cable.

### Sine wave filter selection

Filters used with SPE must be selected according to motor current and filter rating at 120 Hz (3600 RPM).

| Part number | Enclosure degree | Switching                             | Filter current rating   |
|-------------|------------------|---------------------------------------|-------------------------|
|             |                  | frequencies to be set manually in CUE | at 200-500 V and 120 Hz |
|             |                  | [kHz]                                 | [A]                     |
| 92617568    | UL type 1/3R     | 4-6                                   | 9                       |
| 92617569    | UL type 1/3R     | 4-6                                   | 12                      |
| 92617580    | UL type 1/3R     | 4-6                                   | 16                      |
| 92617581    | UL type 1/3R     | 4-6                                   | 23                      |
| 92617582    | UL type 1/3R     | 4-6                                   | 30                      |
| 92617583    | UL type 1/3R     | 4-6                                   | 35                      |
| 92617587    | UL type 1/3R     | 4-6                                   | 45                      |
| 92617588    | UL type 1/3R     | 4-6                                   | 55                      |
| 92617589    | UL type 1/3R     | 4-6                                   | 65                      |
| 92617590    | UL type 1/3R     | 4-6                                   | 80                      |
| 92617591    | UL type 1/3R     | 4-6                                   | 110                     |

## Cables in CUE installations

When CUE is used with SPE pumps, Grundfos distinguishes between two types of installation:

- installation in EMC-insensitive sites. See fig. below.
- installation in EMC-sensitive sites. See fig. below.

The two types of installation are different when it comes to the use of screened cable.

**Note:** Drop cables are always unshielded.

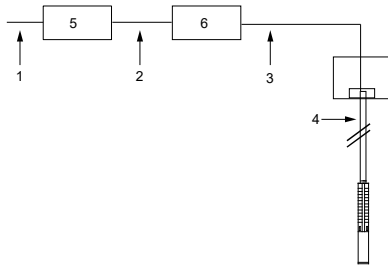

TM085636

*Example of normal installation*

| Pos. | Description             |
|------|-------------------------|
| 1    | Mains cable, unscreened |
| 2    | Screened cable          |
| 3    | Unshielded cable        |
| 4    | Drop cable, unshielded  |
| 5    | CUE                     |
| 6    | Sine-wave filter        |

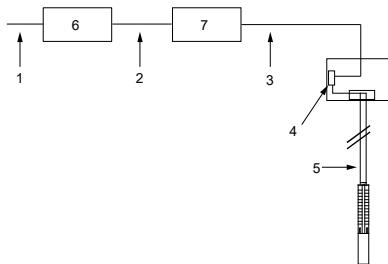

TM085638

*Example of installation in EMC-sensitive sites*

| Pos. | Description             |
|------|-------------------------|
| 1    | Mains cable, unscreened |
| 2    | Screened cable          |
| 3    | Screened cable          |
| 4    | Connection box          |
| 5    | Drop cable, unshielded  |
| 6    | CUE                     |
| 7    | Sine-wave filter        |

Screened cables are required in parts of the installation where the surroundings must be protected against EMC.

CUE is the right choice of variable frequency drive in SPE installations as it meets all basic issues.

CUE has a pre-installed startup guide which takes the installer through all the necessary settings.

The table below shows the different issues to be considered when using variable frequency drive in SPE installations.

| Issues  | Explanation  |
|---|--|
| Ramp (up and down):<br>maximum 3 seconds.   | The journal bearings must be lubricated to limit wear and overheating of windings.   |
| Temperature monitoring by a Pt sensor.  | Overheating of the motor leads to low insulation resistance which is sensitive to voltage peaks.<br>Tempcon sensors do not work with variable frequency drive operation.                         |
| Reduce peak voltages (maximum 800 V peaks).   | Never exceed peak voltages of 850 V at motor leads.  |
| Remember output filter.   | Cables act as an amplifier. Measure peaks at the motor.  |
| Rise time (dU/dt) must be limited to a maximum of 1000 V/ $\mu$ s.<br>It is determined by the equipment in CUE. | As the time between switches is an expression of losses, the limit of 1000 V/ $\mu$ s can be exceeded.<br>The solution is not higher insulation of the motor, but filter in the output from CUE. |
| Constant operation at minimum 55 Hz.  | Too low speed results in low flow and poor lubrication of journal bearings.  |
| Size CUE compared to the current, not the power output.   | Can end up with a too small CUE.   |
| Size cooling provision for stator tube at duty point with lowest flow rate.                                     | Flow minimum ft/s along the stator housing must be considered.   |
| Ensure that the pump is used within the range of the pump curve.  | Focus on outlet pressure and sufficient Net Positive Suction Head, as vibrations can damage or destroy the motor.  |

## Using variable frequency drives of other brands

The following parameters are relevant when using variable frequency drives of other brands.

### Data for 120 Hz / 3 × 410 V motor voltage

|                                | Power range [hp] |      |     |     |
|--------------------------------|------------------|------|-----|-----|
|                                | 10               | 25   | 40  | 50  |
| PM back EMF at 120 Hz [V]      | 320              | 312  | 324 | 295 |
| PM d-axis inductance (Ld) [mH] | 11.0             | 4.6  | 3.4 | 2.1 |
| PM q-axis inductance (Lq) [mH] | 26.4             | 11.7 | 8.0 | 5.5 |
| PM type designation            | IPM              |      |     |     |
| Frequency [Hz]                 | 120              |      |     |     |
| Number of poles                | 4                |      |     |     |

### Grundfos offerings, easy selection

| MS6000P single packed with cable   |             |                | CUE (120 Hz)                 |                            |                       | Sine wave filter (120 Hz) |             |
|------------------------------------|-------------|----------------|------------------------------|----------------------------|-----------------------|---------------------------|-------------|
| Motor voltage 3 × 410 V (3600 RPM) |             |                | 3 × 380-500V Nema 4X outdoor | 3 × 380-500V Nema 1 indoor | TCI indoor/outdoor 3R |                           |             |
| Part number                        | Output [hp] | SF Current [A] | Part number                  | Part number                | Current [A]           | Part number               | Current [A] |
| 9984343                            | 5.0         | 8.8            | 99619042                     | 99616714                   | 11                    | 92617568                  | 9           |
|                                    | 7.5         | 12.4           | 99619043                     | 99616715                   | 14.5                  | 92617569                  | 12          |
|                                    |             |                |                              |                            |                       | 92617580                  | 16          |
| 99843439                           | 10          | 16.2           | 99619044                     | 99616716                   | 21                    | 92617581                  | 23          |
|                                    | 15          | 24.5           | 99619045                     | 99616717                   | 27                    | 92617582                  | 30          |
|                                    |             |                |                              |                            |                       | 92617583                  | 35          |
|                                    | 20          | 32.2           | 99619046                     | 99616718                   | 34                    | 92617587                  | 45          |
| 25                                 | 39.0        | 99619047       | 99616719                     | 40                         | 92617588              | 55                        |             |
| 99843440                           | 30          | 44.8           | 99619048                     | 99616720                   | 52                    | 92617589                  | 65          |
|                                    | 40          | 60.0           | 99619049                     | 99616721                   | 65                    | 92617591                  | 110         |
| 99843441                           | 50          | 82.6           | 99619051                     | 99616723                   | 105                   |                           |             |

## 5. Selection and sizing

Grundfos Product Center can calculate the exact duty point and energy consumption.

For further information, see Grundfos Product Center at <https://product-selection.grundfos.com>.

Select the pump based on the following parameters:

- duty point (see below)
- friction loss in the pipes, pump efficiency (see below)

- materials (see SPE 85S - SPE 300S)
- connections (see SPE 385S- SPE 1100S).

### Duty point of the pump

With the help of a duty point, it is possible to select a pump based on the curve charts in section Performance curves and technical data.

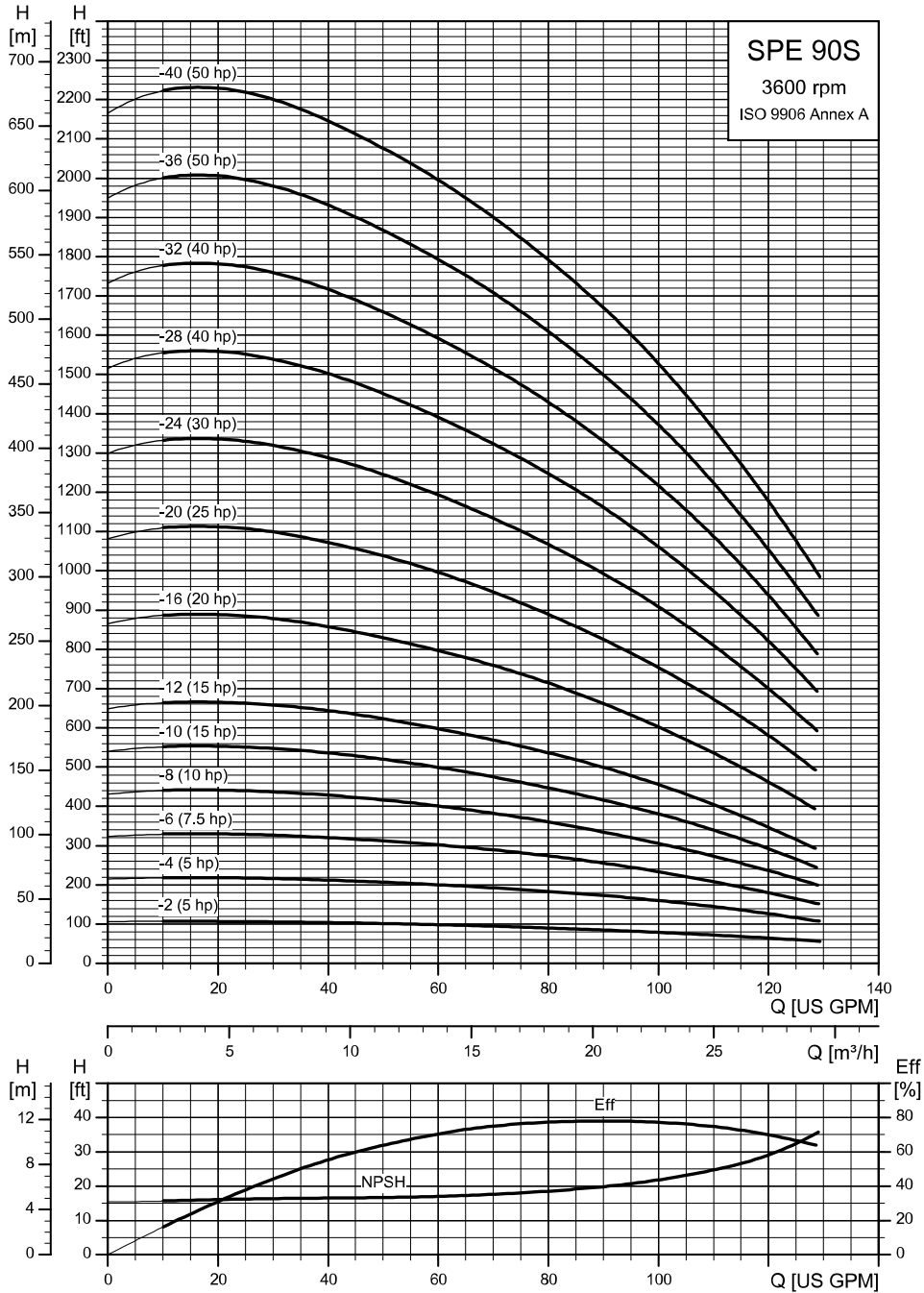

Example of a curve chart

TM084245

**Dimensional data**

When sizing a pump, take the following parameters into account:

- required flow and pressure at the draw-off point
- friction loss in the pipes ( $H_f$ )
- pressure loss in for example, long pipes, bends, valves
- best efficiency at the estimated duty point

- NPSH value. For calculation of the NPSH value, see Grundfos Product Center.

**Pump efficiency**

Before determining the best efficiency point, identify the operation pattern of the pump. If the pump is expected to operate at the same duty point, select a pump which operates at a duty point corresponding to the best efficiency.

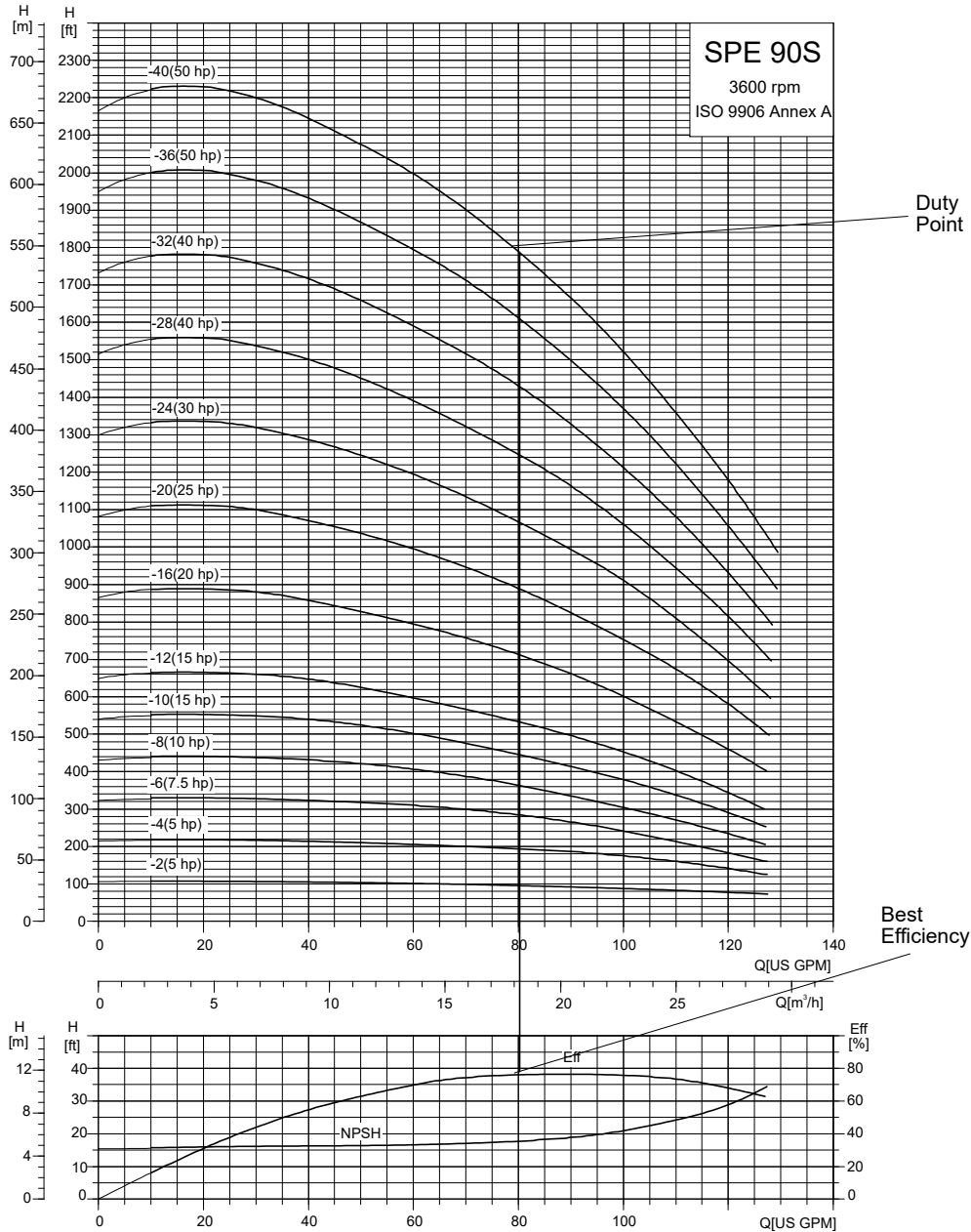

TM085875

As the pump is sized based on the highest possible flow, it is important to have the duty point to the right on the efficiency curve (Eta) in order to keep the efficiency high when the flow drops.

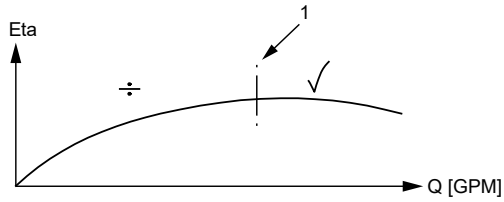

TM081996

**Best efficiency**

E-pumps are used in applications characterized by a variable flow. It is not possible to select a pump that is constantly operating at optimum efficiency.

To achieve optimum operating economy, select the pump based on the following criteria:

- The maximum duty point required must be as close as possible to the QH curve of the pump.
- The flow rate at the duty point required must be close to the optimum efficiency (Eta) for most operating hours.

Between the minimum and maximum performance curves, E-pumps have a large number of performance curves, each representing a specific speed. Therefore, it may not be possible to select a duty point close to the Max. curve.

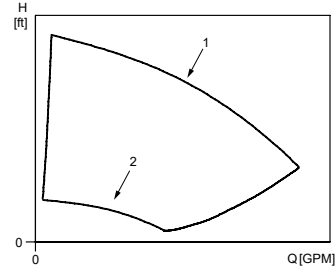

TM081997

**Min. and max. performance curves**

| Pos. | Description |
|------|-------------|
| 1    | Max. curve  |
| 2    | Min. curve  |

In situations where it is not possible to select a duty point close to the Max. curve, the below affinity equations can be used. The following are the appropriate variables for the motor speed (n):

- head (H)
- flow (Q)
- input power (P).

The approximated formulas only apply when the system characteristic remains unchanged for  $n_n$  and  $n_x$  and when it is based on the formula  $H = k \times Q^2$  where k is a constant. The power equation implies that the pump efficiency is unchanged at the two speeds. In practice, this is an acceptable approximation.

To obtain a precise calculation of the power savings resulting from a reduction of pump speed, the efficiencies of the variable frequency drive and the motor must be taken into account.

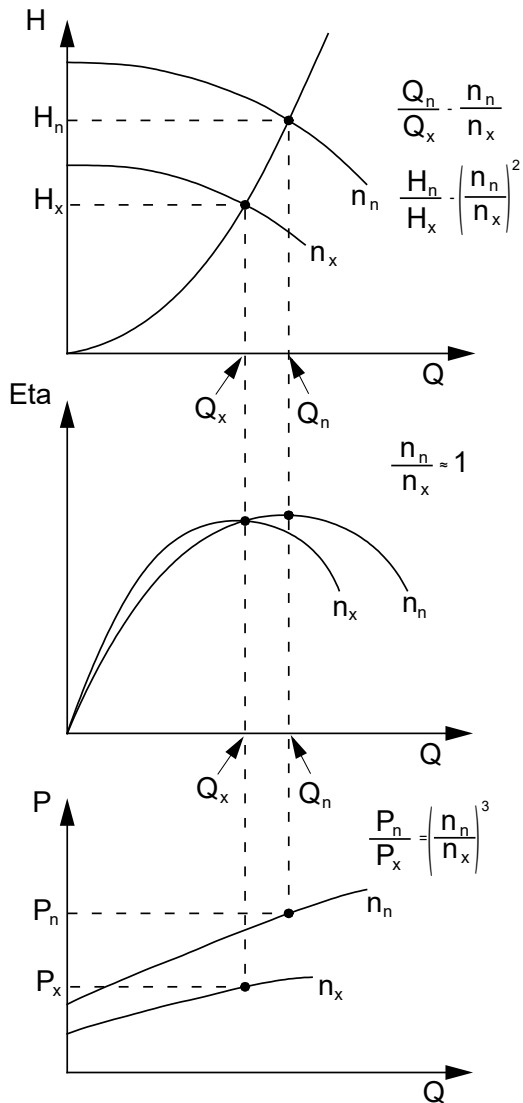

TM008720

### Affinity equations

|          |   |
|----------|---|
| $H_n$    | Rated head [ft]   |
| $H_x$    | Actual head [ft]  |
| $Q_n$    | Rated flow rate [GPM]   |
| $Q_x$    | Actual flow rate [GPM]  |
| $P_n$    | Rated input power [hp]  |
| $P_x$    | Actual input power [hp]   |
| $n_n$    | Rated motor speed [ $\text{min}^{-1}$ ] ( $n_n = 3600 \text{ min}^{-1}$ ) |
| $n_x$    | Actual motor speed [ $\text{min}^{-1}$ ]                                  |
| $\eta_n$ | Rated efficiency [%]  |
| $\eta_x$ | Actual efficiency [%]   |

For further information, see Grundfos Product Center at <https://product-selection.grundfos.com>.



## 6. Operating conditions

Observe the following to ensure the efficient and long lifespan of the product.

### Inlet pressure

The minimum inlet pressure is indicated by the NPSH-curves in the single-stage curve charts.

The minimum safety margin of the NPSH-curves must always be 1.5 ft head.

### Min. flow rate

To ensure sufficient cooling of the motor, the pump must not run continuously at a flow rate below  $0.1 \times$  nominal flow rate.

Operation against a closed valve must be limited to a maximum of 30 seconds to minimize the risk of the pumped liquid heating up and damaging the pump and the motor.

### Max. flow rate

The pump must not run continuously at a flow rate above  $1.3 \times$  nominal flow rate due to the risk of upthrust and cavitation.

### Pumped liquids

SPE pumps are capable of pumping clean, thin, non-aggressive liquids, not containing solid particles or fibres larger than sand grains.

| Pump type            | Maximum content of sand [ppm] |
|----------------------|-------------------------------|
| SPE 90S - SPE 300S   | 100                           |
| SPE 385S - SPE 1100S | 50                            |

### Special liquids

A larger sand content reduces the lifespan of the pump. The following versions are available for applications involving aggressive liquids:

- SPE-N made of stainless steel AISI 316
- SPE-R made of stainless steel AISI 904L.

Pumping liquids with a higher density than water requires a motor with a correspondingly higher output.

Pumping of liquids with a higher viscosity than water may result in the following:

- increased pressure loss
- reduced hydraulic performance
- increased pump power input.

In case of concerns, contact Grundfos.

### Liquid temperature

For protection of pump and motor rubber parts, the liquid temperature must not exceed 140 °F.

### Max. liquid temperature

The maximum liquid temperature of 140 °F requires a flow velocity of the liquid past the motor of 0.5 ft/s.

### Max. operating pressure

Maximum operating pressure is 870 psi.

### Ramp times

A maximum of 3 seconds for start 0-55 Hz and for stop 55-0 Hz.

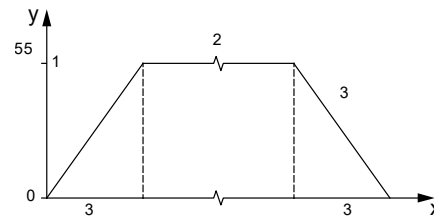

TM076100

### Ramp times

| Pos. | Description    |
|------|----------------|
| 1    | Start          |
| 2    | Operation      |
| 3    | Stop           |
| x    | Time [s]       |
| y    | Frequency [Hz] |

## Service

Contact Grundfos with details about the pumped liquid before returning the product for service. Otherwise Grundfos can refuse to accept the pump. Possible costs of returning the pump are paid by the customer.

Any application for service must include details about the pumped liquid. The product is classified as contaminated if it is used for contagious or toxic liquid.

Clean the product in the best possible way before returning it.

**Important:** Make sure to mention that it is a permanent magnet motor.

## Pump functioning as turbine

In case of unintended water flow through a non-energized pump, there is a risk that the moving parts of the pump and the motor start rotating, and generating voltage over the terminals. The size of the voltage depends on the speed of rotation. The motor terminals must be considered as live until proven otherwise.

## Start/stop

The SPE pump is suitable for continuous as well as intermittent operation.

- Minimum one start per year is recommended.
- Maximum 120 starts per hour.
- Maximum 360 starts per day.
- If a switch or a sensor is used to start and stop the pump set, the signal has to be connected correctly to the variable frequency drive.
- The variable frequency drive can be disconnected from the mains maximum two times per minute.

## Sound pressure level

The sound pressure level is measured in accordance with the rules of the the EC machinery directive 2006/42/EC.

### Sound pressure level of pumps

The values apply to pumps submerged in water without an external regulating valve.

| Pump type | L <sub>pA</sub> [dB(A)] |
|-----------|-------------------------|
| SPE 90S   | < 70                    |
| SPE 160S  | < 70                    |
| SPE 230S  | < 70                    |
| SPE 300S  | < 70                    |
| SPE 385S  | < 70                    |
| SPE 475S  | < 70                    |
| SPE 625S  | 79                      |
| SPE 800S  | 79                      |
| SPE 1100S | 82                      |

### Sound pressure level of motors

The sound pressure level is lower than 70 dB(A).

## Moment of inertia

Calculate the moment of inertia by using one of the formulas below. Choose the formula according to the pump type and insert the number of stages.

| Pump type | Moment of inertia [lb ft <sup>2</sup> ] |
|-----------|---|
| SPE 90S   | $(100 + n \times 50) \times 10^{-4}$    |
| SPE 160S  | $(100 + n \times 125) \times 10^{-4}$   |
| SPE 230S  | $(100 + n \times 90) \times 10^{-4}$    |
| SPE 300S  | $(100 + n \times 100) \times 10^{-4}$   |
| SPE 385S  | $(140 + n \times 475) \times 10^{-4}$   |
| SPE 475S  | $(140 + n \times 550) \times 10^{-4}$   |
| SPE 625S  | $(140 + n \times 825) \times 10^{-4}$   |
| SPE 800S  | $(140 + n \times 825) \times 10^{-4}$   |
| SPE 1100S | $(625 + n \times 2500) \times 10^{-4}$  |

n = number of stages.

## Recommended minimum borehole diameter

If using a connecting piece in the installation, the recommended minimum borehole diameter is the largest diameter of either pump or connecting piece.

The following table shows the recommended minimum borehole diameter of SPE pumps with standard connections.

| Pumps size          | Number of cables | Sleeve | Minimum borehole diameter<br>[Inches] |        |        |
|---------------------|------------------|--------|---------------------------------------|--------|--------|
|                     |                  |        | NPT 3"                                | NPT 4" | NPT 6" |
| SPE 90S / SPE 160S  | 1                | -      | 5.8                                   | -      | -      |
| SPE 230S            | 1                | -      | 6.0                                   | -      | -      |
| SPE 300S            | 1                | -      | 6.0                                   | 6.0    | -      |
| SPE 385S / SPE 475S | 1                | -      | -                                     | 7.2    | -      |
| SPE 625S / SPE 800S | 1                | -      | -                                     | -      | 8.5    |
| SPE 1100S           | 1                | -      | -                                     | -      | 9.5    |

## How to read the curve charts

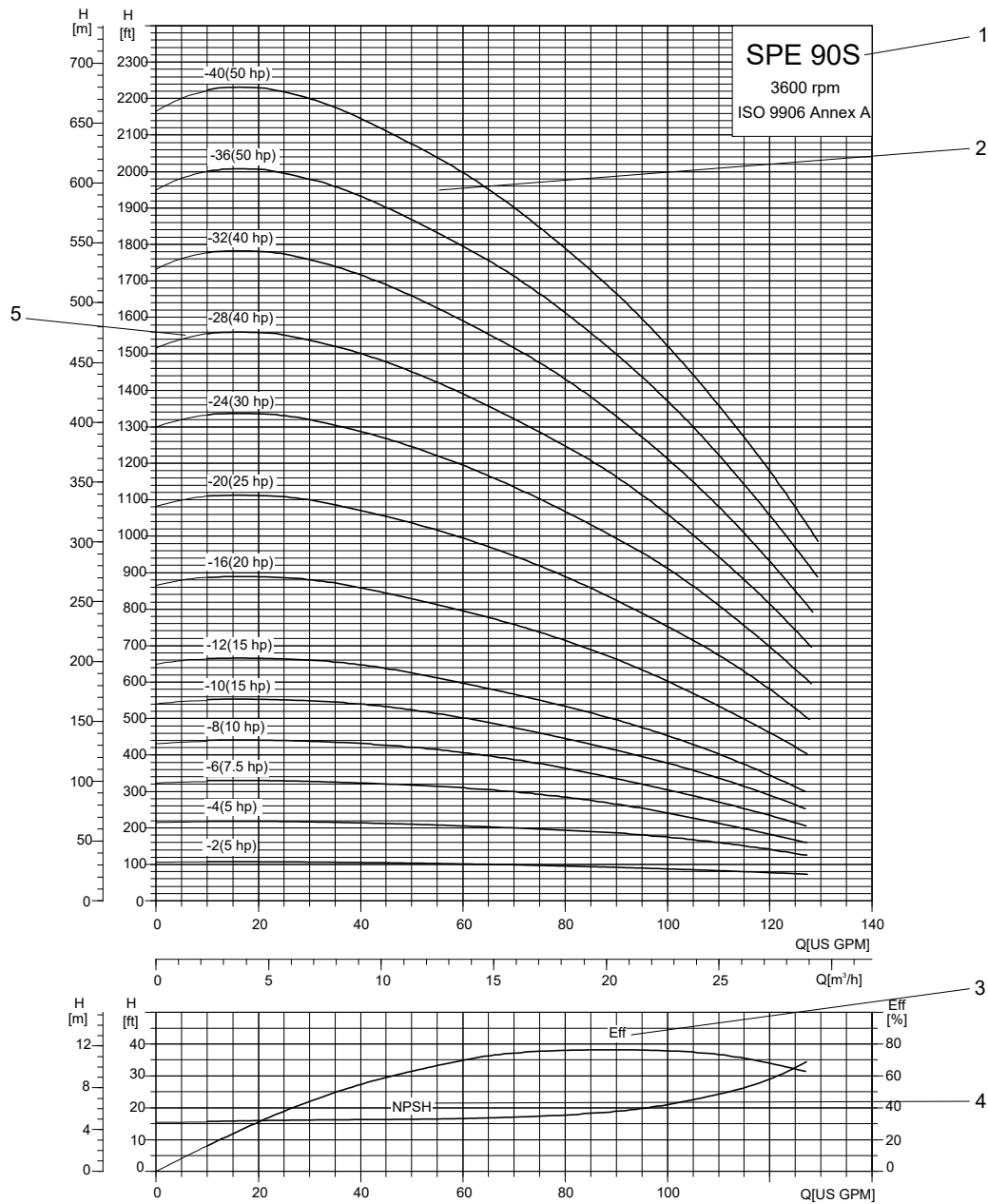

TM085874

| Pos. | Description   |
|------|---|
| 1    | Pump type   |
| 2    | QH curve for the individual pump. The bold curves indicate the recommended duty range for best efficiency.                    |
| 3    | The Eta curve shows the stage efficiency. Pumps with fewer stages have a lower efficiency than the curve shows.               |
| 4    | The NPSH curve is an average curve for all the variants shown. When sizing the pumps, add a safety margin of at least 1.5 ft. |
| 5    | Number of stages.   |

## Curve conditions

The conditions below apply to the curves at Performance curves and technical data.

### General conditions

- Curve tolerances according to ISO 9906:2012 - Grade 3B.
- The performance curves show pump performance at  $n = 3600 \text{ min}^{-1}$ .
- The measurements are made with airless water at a temperature of 68 °F. The curves apply to a kinematic viscosity of 1 cSt. When pumping liquids with a density higher than water, use motors with correspondingly higher outputs.
- The bold curves indicate the recommended performance range.
- The performance curves include possible losses, such as non-return valve loss.

### Curves

- **Q/H:** The curves include valve- and inlet losses at the actual speed. Operations without a non-return valve increase the actual head at rated performance by 1.6 to 3.3 ft.
- **NPSH:** The curve includes pressure loss in the suction interconnector and shows the required inlet pressure.
- **Power curve:** P2 shows the pump power input of each stage for the individual pump size when the pump is running at the rated speed.
- **Efficiency curve:** Eta shows pump stage efficiency. If Eta for the actual pump size is needed, contact Grundfos or visit Grundfos Product Center <https://product-selection.grundfos.com>.

# 7. Performance curves and technical data

## SPE 90S

### Performance curves

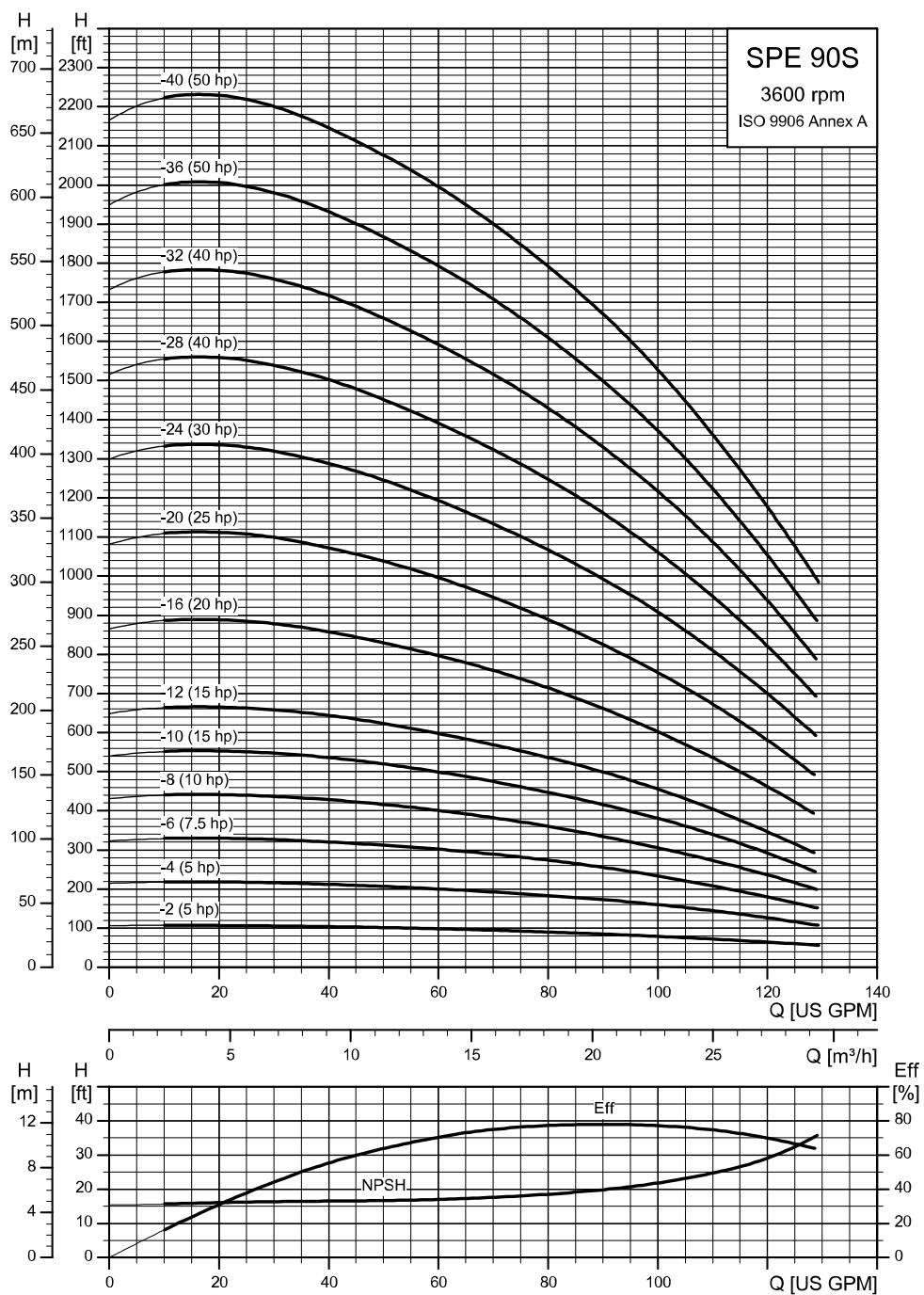

TM084245

## Dimension and weights

### SPE 90S (90 gpm) pump

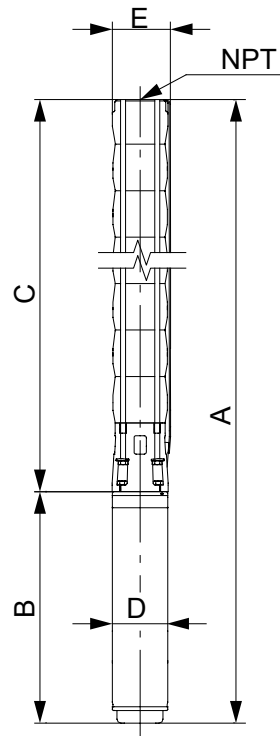

TM081341

| Pump model  | Nom. head [ft] | Motor | Dimensions [in] |       |        |   |      | Net weight (complete) [lb] |
|---|----------------|-------|-----------------|-------|--------|---|------|----------------------------|
|   |                | [Hp]  | A               | B     | C      | D | E    |                            |
| <b>90S, 60 Hz - rated flow rate 90 gpm (3" NPT)</b> |                |       |                 |       |        |   |      |                            |
| SPE 90S-2   | 89             | 5     | 39.33           | 23.50 | 15.83  | 6 | 5.49 | 119.0                      |
| SPE 90S-4   | 179            | 5     | 44.09           | 23.50 | 20.59  | 6 | 5.49 | 125.1                      |
| SPE 90S-6   | 271            | 7.5   | 48.86           | 23.50 | 25.35  | 6 | 5.49 | 131.1                      |
| SPE 90S-8   | 359            | 7.5   | 53.62           | 23.50 | 30.12  | 6 | 5.49 | 137.1                      |
| SPE 90S-10  | 450            | 10    | 58.39           | 23.50 | 34.88  | 6 | 5.49 | 143.2                      |
| SPE 90S-12  | 542            | 15    | 67.87           | 28.23 | 39.65  | 6 | 5.49 | 176.8                      |
| SPE 90S-16  | 724            | 15    | 77.40           | 28.23 | 49.17  | 6 | 5.49 | 188.9                      |
| SPE 90S-20  | 906            | 20    | 86.93           | 28.23 | 58.70  | 6 | 5.49 | 201.0                      |
| SPE 90S-24  | 1089           | 25    | 96.46           | 28.23 | 68.23  | 6 | 5.49 | 213.0                      |
| SPE 90S-28  | 1271           | 25    | 105.98          | 28.23 | 77.76  | 6 | 5.49 | 225.1                      |
| SPE 90S-32  | 1453           | 30    | 136.02          | 34.13 | 101.89 | 6 | 6.89 | 274.9                      |
| SPE 90S-36  | 1635           | 40    | 145.55          | 34.13 | 111.42 | 6 | 6.89 | 351.9                      |
| SPE 90S-40  | 1818           | 40    | 155.08          | 34.13 | 120.94 | 6 | 6.89 | 366.6                      |

#### Note:

Performance conforms to ISO 9906:2012, Grade 3B.

Minimum submergence is 5 ft.

Power curves

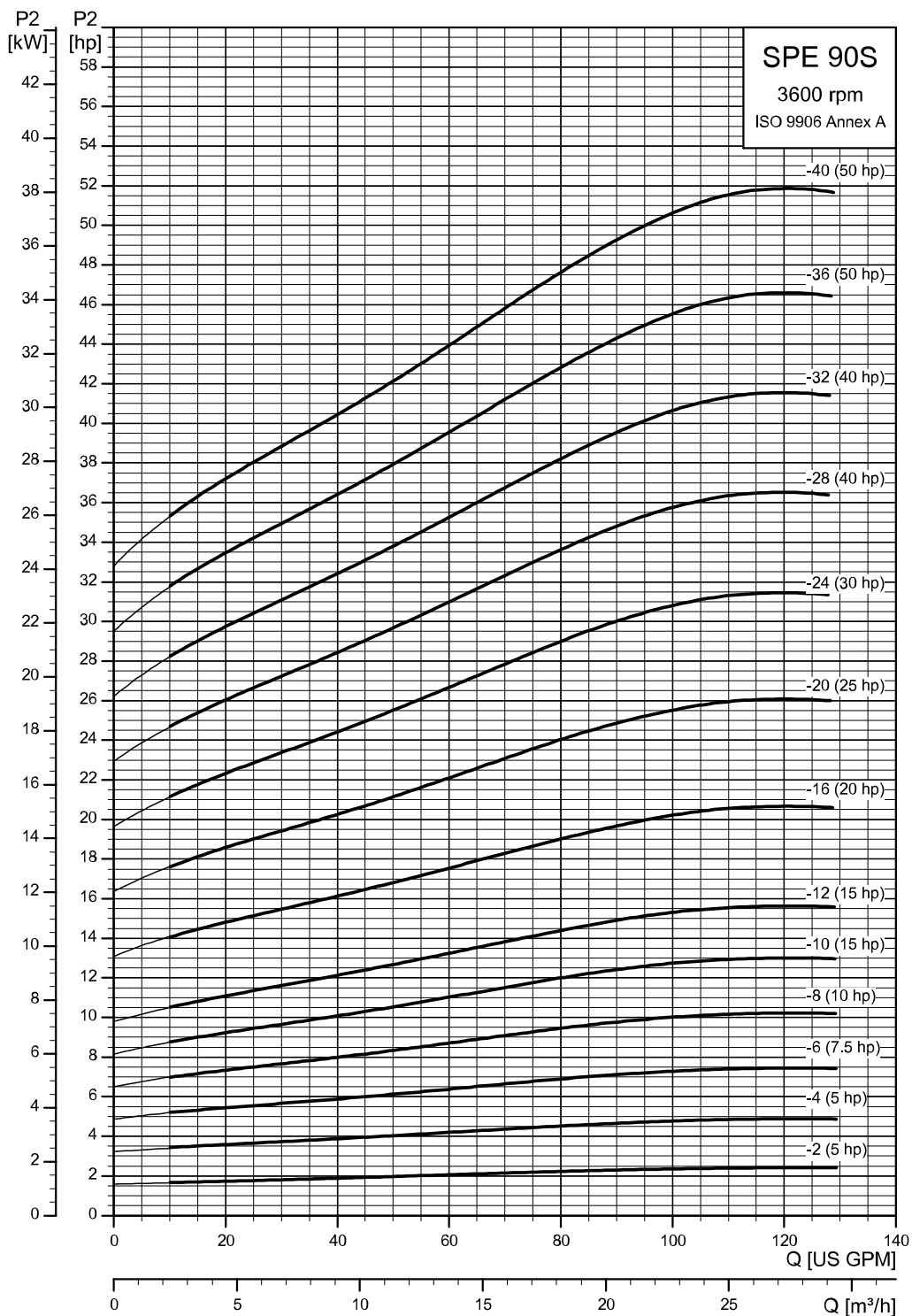

TM084246



# SPE 160S

## Performance curves

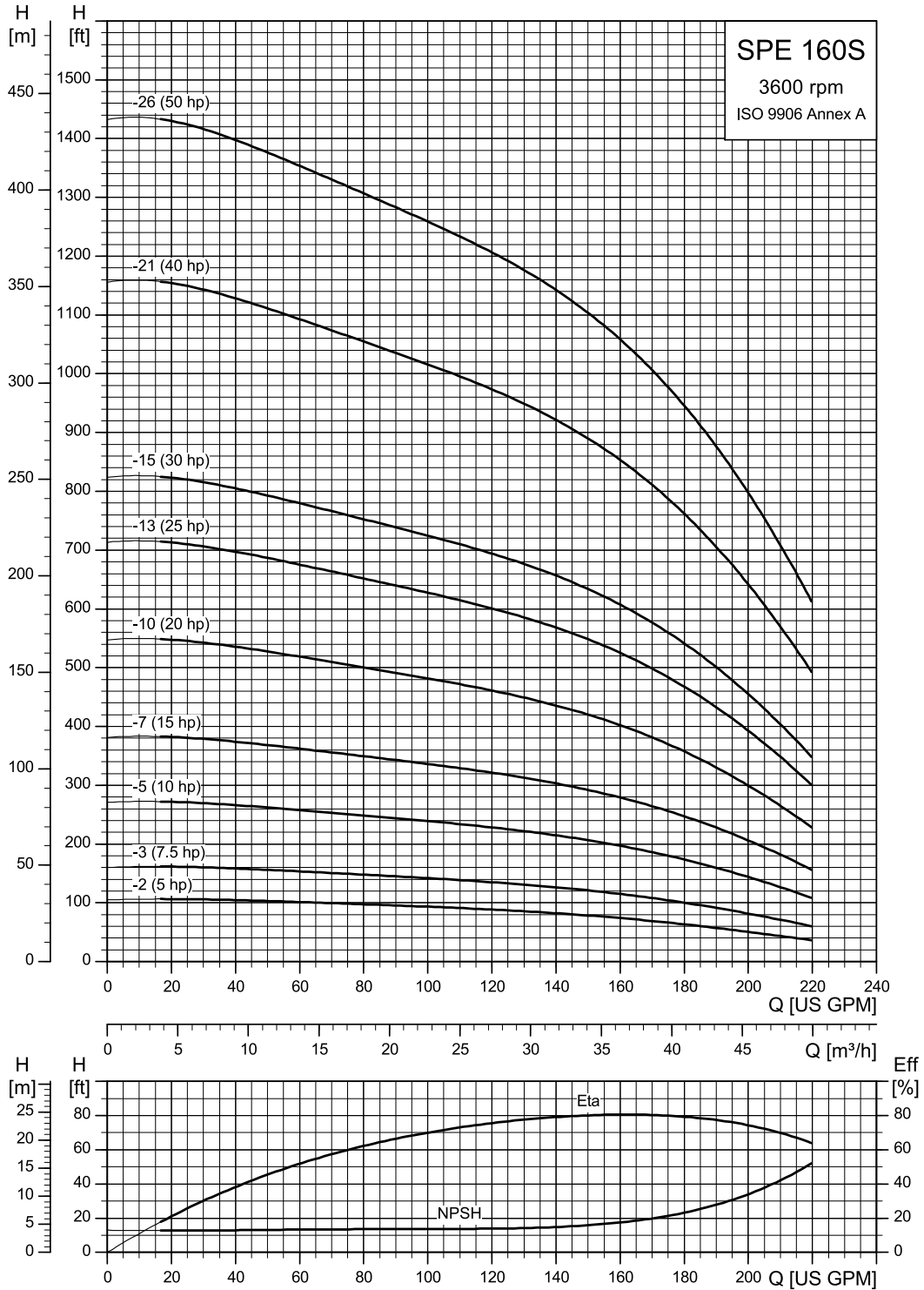

TM087029

## Dimensions and weights

### SPE 160S (160 gpm) pump

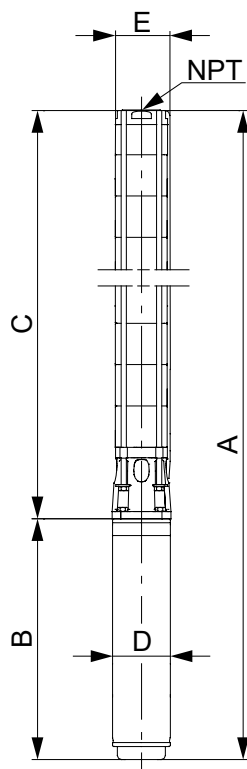

TM081342

| Pump model  | Nom. head [ft] | Motor | Dimensions [in] |       |        |   |      | Net weight (complete) [lb] |
|---|----------------|-------|-----------------|-------|--------|---|------|----------------------------|
|   |                | [Hp]  | A               | B     | C      | D | E    |                            |
| <b>160S, 60 Hz - rated flow rate 160 gpm (3" NPT)</b> |                |       |                 |       |        |   |      |                            |
| SPE 160S-2  | 83             | 5     | 42.13           | 23.50 | 18.62  | 6 | 5.59 | 121.0                      |
| SPE 160S-3  | 125            | 7.5   | 45.91           | 23.50 | 22.40  | 6 | 5.59 | 125.3                      |
| SPE 160S-5  | 209            | 10    | 53.46           | 23.50 | 29.96  | 6 | 5.59 | 133.8                      |
| SPE 160S-7  | 292            | 15    | 65.75           | 28.23 | 37.52  | 6 | 5.59 | 169.9                      |
| SPE 160S-10   | 419            | 20    | 77.09           | 28.23 | 48.86  | 6 | 5.59 | 182.8                      |
| SPE 160S-13   | 545            | 25    | 88.43           | 28.23 | 60.20  | 6 | 5.59 | 195.6                      |
| SPE 160S-15   | 624            | 30    | 101.89          | 34.13 | 67.76  | 6 | 5.59 | 241.8                      |
| SPE 160S-18   | 749            | 40    | 113.23          | 34.13 | 79.09  | 6 | 5.59 | 254.7                      |
| SPE 160S-21   | 876            | 40    | 124.57          | 34.13 | 90.43  | 6 | 5.59 | 267.5                      |
| SPE 160S-24   | 1001           | 50    | 141.02          | 39.25 | 101.77 | 6 | 5.59 | 309.0                      |
| SPE 160S-26   | 1086           | 50    | 144.58          | 39.25 | 109.33 | 6 | 5.59 | 317.6                      |

#### Note:

Performance conforms to ISO 9906:2012, Grade 3B.

Minimum submergence is 5 ft.

Power curves

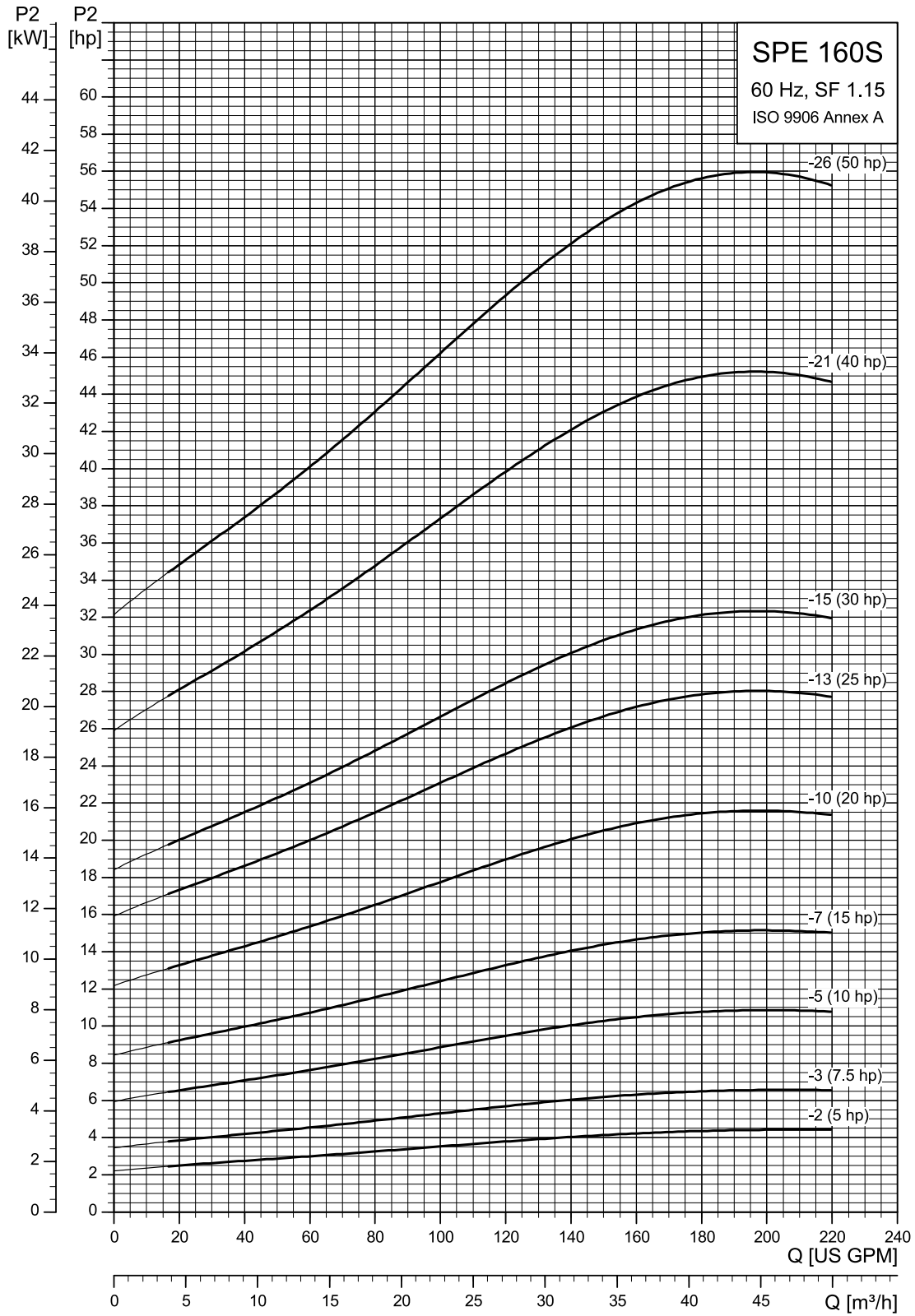

TM087030

# SPE 230S

## Performance curves

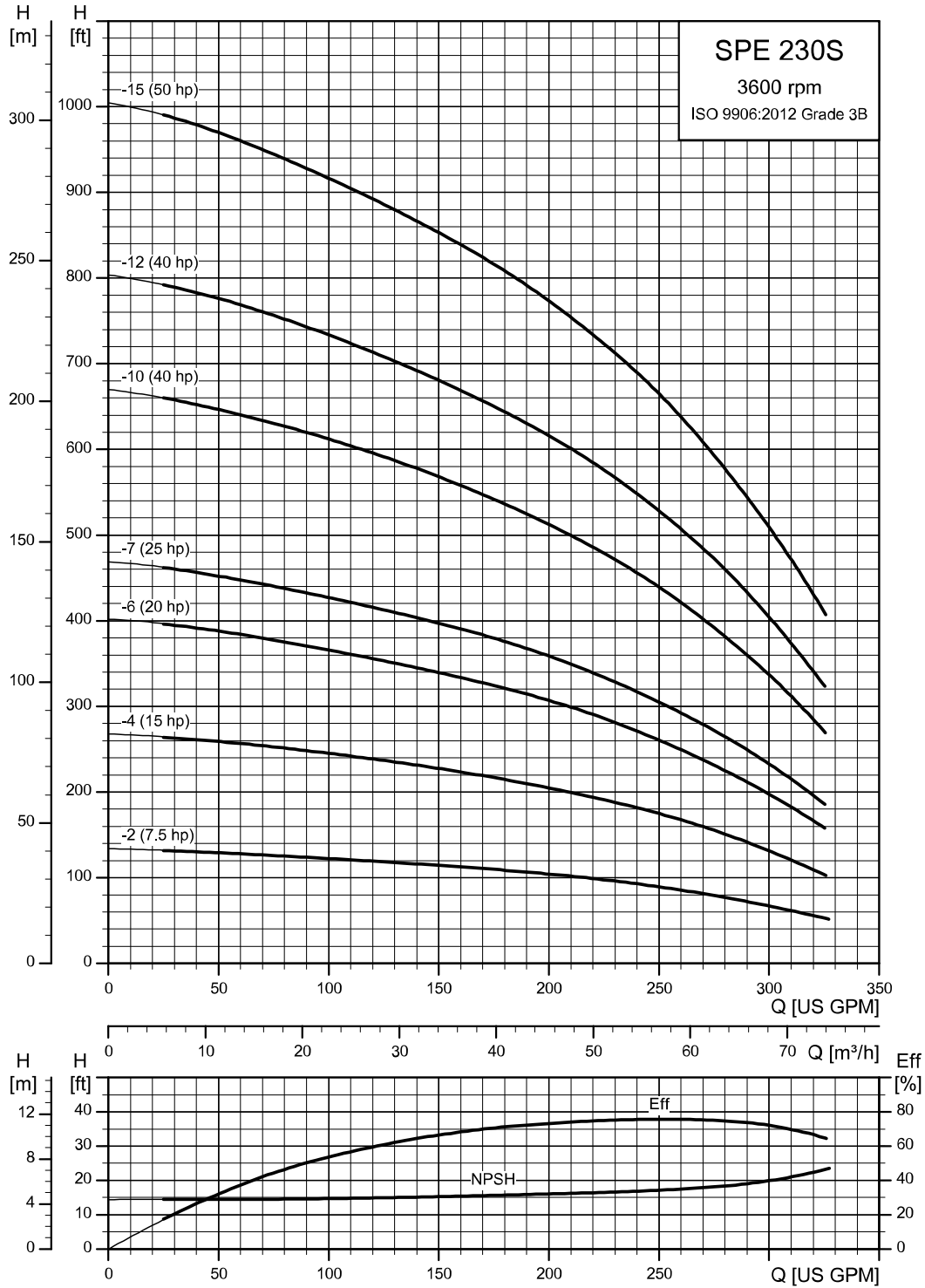

TM081077

## Dimensions and weights

### SPE 230S (230 gpm) pump

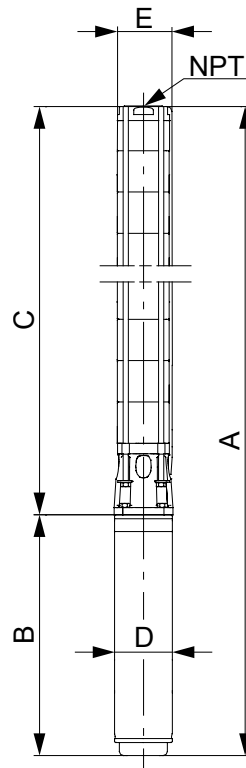

TM081342

| Pump model  | Nom. head [ft] | Motor | Dimensions [in] |       |       |   |      | Net weight (complete) [lb] |
|---|----------------|-------|-----------------|-------|-------|---|------|----------------------------|
|   |                | [Hp]  | A               | B     | C     | D | E    |                            |
| <b>230S, 60 Hz - rated flow rate 230 gpm (3" NPT)</b> |                |       |                 |       |       |   |      |                            |
| SPE 230S-2  | 93             | 7.5   | 43.46           | 23.50 | 19.96 | 6 | 5.83 | 125.4                      |
| SPE 230S-4  | 183            | 15    | 57.09           | 28.23 | 28.86 | 6 | 5.83 | 163.6                      |
| SPE 230S-6  | 271            | 20    | 65.98           | 28.23 | 37.76 | 6 | 5.83 | 174.2                      |
| SPE 230S-7  | 317            | 25    | 70.43           | 28.23 | 42.20 | 6 | 5.83 | 179.5                      |
| SPE 230S-10   | 449            | 40    | 89.69           | 34.13 | 55.55 | 6 | 5.83 | 233.0                      |
| SPE 230S-12   | 540            | 40    | 98.58           | 34.13 | 64.45 | 6 | 5.83 | 243.6                      |
| SPE 230S-15   | 676            | 50    | 117.05          | 39.25 | 77.80 | 6 | 5.83 | 288.1                      |

#### Note:

Performance conforms to ISO 9906:2012, Grade 3B.

Minimum submergence is 8 ft.

Power curves

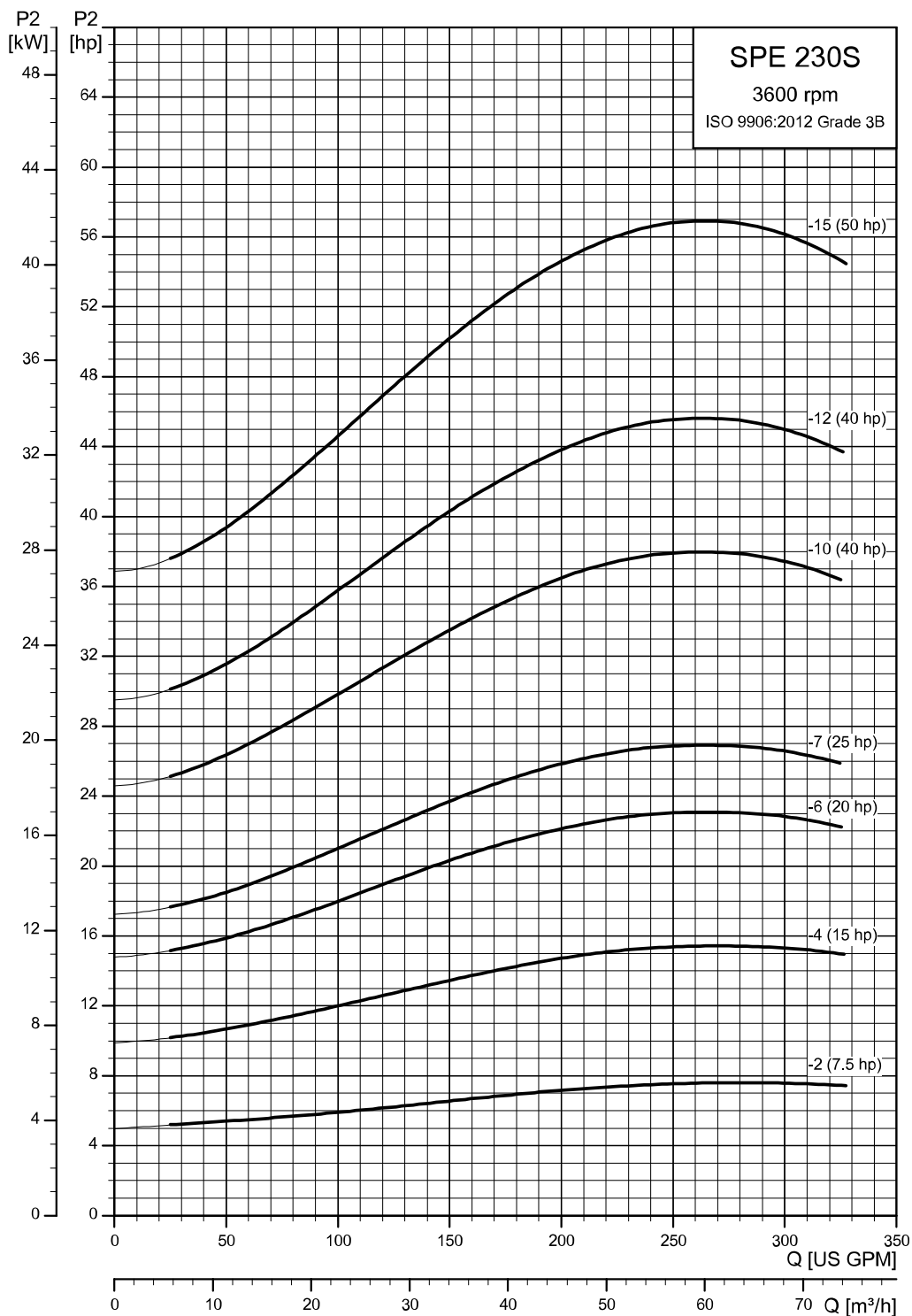

TM081078

# SPE 300S

## Performance curves

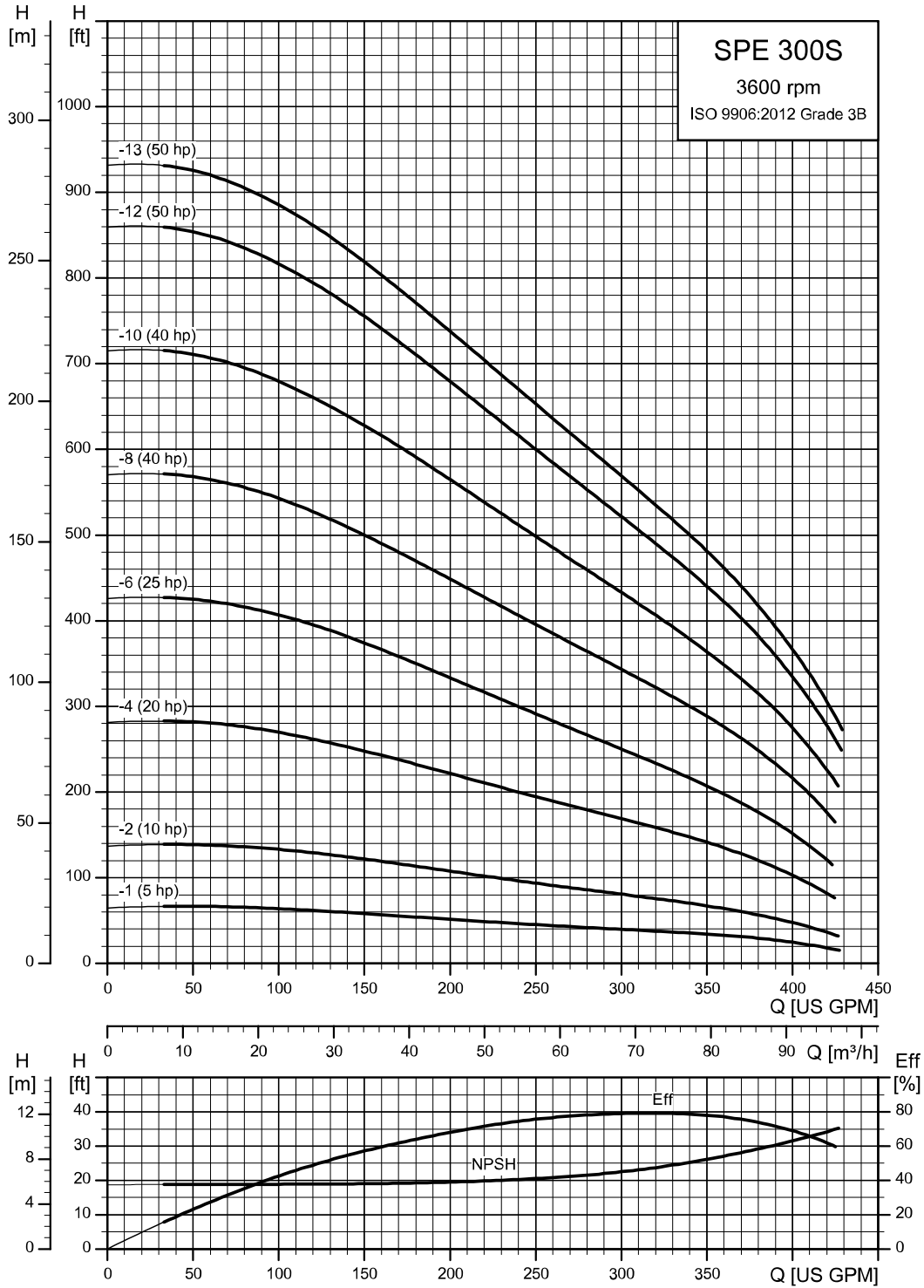

TM081079

## Dimensions and weights

### SPE 300S (300 gpm) pump

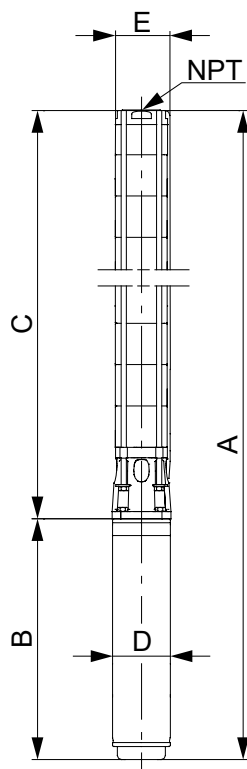

TM081342

| Pump model   | Nom. head [ft] | Motor [Hp] | Dimensions [in] |       |       |   |      | Net weight (complete) [lb] |
|--|----------------|------------|-----------------|-------|-------|---|------|----------------------------|
|  |                |            | A               | B     | C     | D | E    |                            |
| <b>300S, 60 Hz - rated flow rate 300 gpm (3" 4" NPT)</b> |                |            |                 |       |       |   |      |                            |
| SPE 300S-1 <sup>2)</sup>                                 | 44             | 5          | 39.02           | 23.50 | 15.51 | 6 | 5.83 | 120.2                      |
| SPE 300S-2 <sup>2)</sup>                                 | 85             | 10         | 43.46           | 23.50 | 19.96 | 6 | 5.83 | 125.4                      |
| SPE 300S-4 <sup>2)</sup>                                 | 169            | 15         | 57.09           | 28.23 | 28.86 | 6 | 5.83 | 163.6                      |
| SPE 300S-6 <sup>2)</sup>                                 | 254            | 25         | 65.98           | 28.23 | 37.76 | 6 | 5.83 | 174.2                      |
| SPE 300S-8 <sup>3)</sup>                                 | 338            | 40         | 80.79           | 34.13 | 46.65 | 6 | 5.83 | 222.4                      |
| SPE 300S-10 <sup>3)</sup>                                | 419            | 40         | 89.69           | 34.13 | 55.55 | 6 | 5.83 | 233.0                      |
| SPE 300S-12 <sup>3)</sup>                                | 505            | 50         | 103.70          | 39.25 | 64.45 | 6 | 5.83 | 272.3                      |
| SPE 300S-13 <sup>3)</sup>                                | 547            | 50         | 108.15          | 39.25 | 68.90 | 6 | 5.83 | 277.6                      |

2) 3" NPT

3) 4" NPT

#### Note:

Performance conforms to ISO 9906:2012, Grade 3B.

Minimum submergence is 8 ft.



Power curves

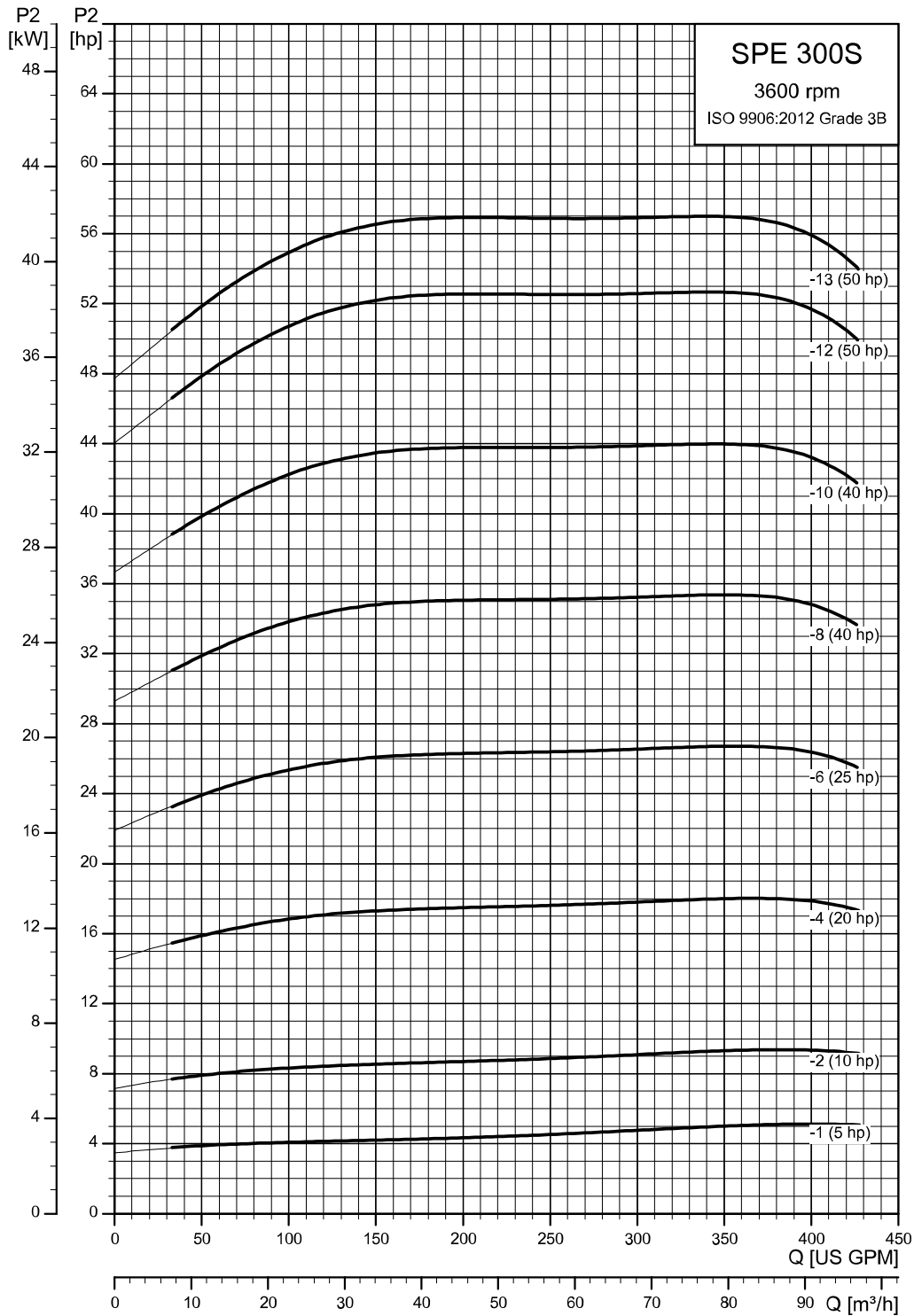

TM081080

# SPE 385S

## Performance curves

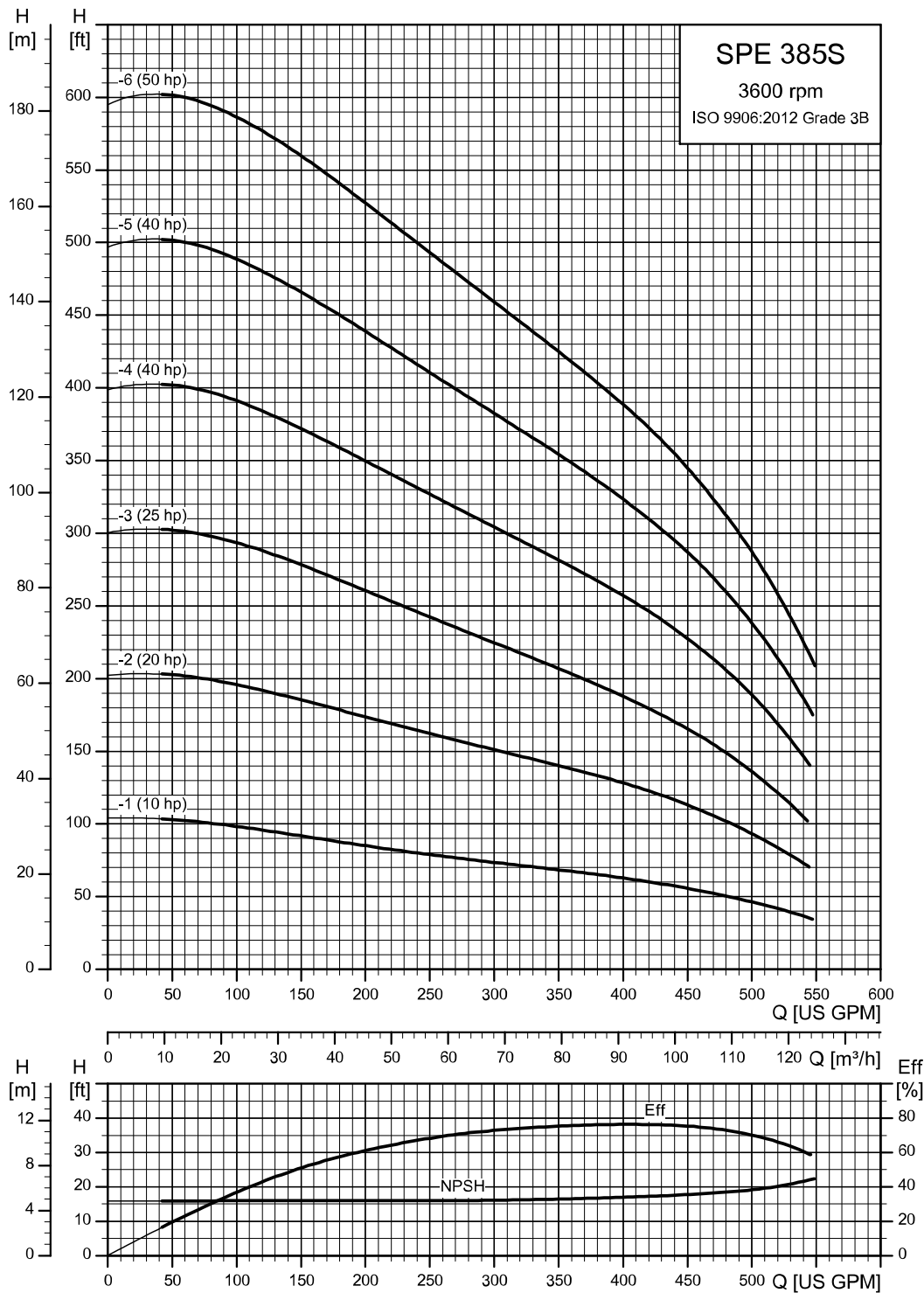

TM081081

## Dimensions and weights

### SPE 385S (385 gpm) pump

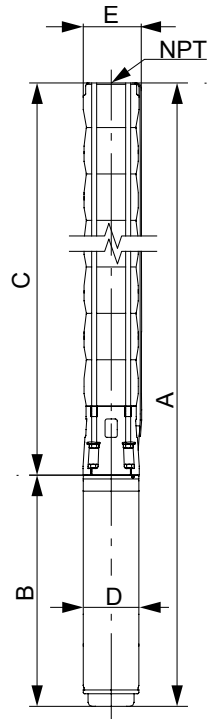

TM081343

| Pump model  | Nom. head [ft] | Motor | Dimensions [in] |       |       |   |      | Net weight (complete) [lb] |
|---|----------------|-------|-----------------|-------|-------|---|------|----------------------------|
|   |                | [Hp]  | A               | B     | C     | D | E    |                            |
| <b>385S, 60 Hz - rated flow rate 385 gpm (4" NPT)</b> |                |       |                 |       |       |   |      |                            |
| SPE 385S-1  | 64             | 10    | 47.83           | 23.50 | 24.33 | 6 | 7.05 | 159.0                      |
| SPE 385S-2  | 129            | 20    | 57.60           | 28.23 | 29.37 | 6 | 7.05 | 195.8                      |
| SPE 385S-3  | 193            | 25    | 62.64           | 28.23 | 34.41 | 6 | 7.05 | 205.0                      |
| SPE 385S-4  | 256            | 40    | 73.58           | 34.13 | 39.45 | 6 | 7.05 | 252.0                      |
| SPE 385S-5  | 321            | 40    | 78.62           | 34.13 | 44.49 | 6 | 7.05 | 261.2                      |
| SPE 385S-6  | 385            | 50    | 88.78           | 39.25 | 49.53 | 6 | 7.05 | 299.2                      |

**Note:**

Performance conforms to ISO 9906:2012, Grade 3B.

Minimum submergence is 8 ft.

### Power curves

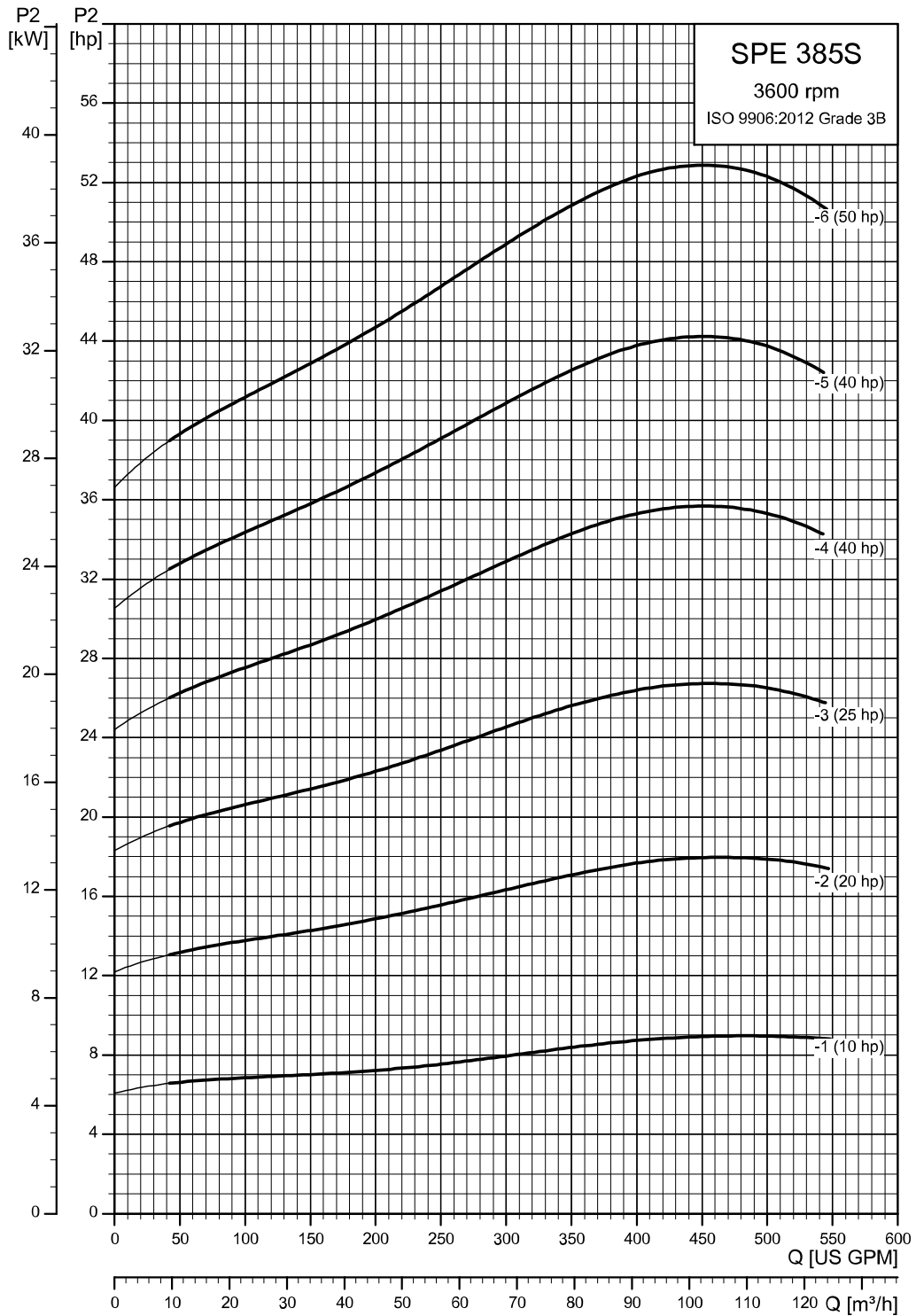

TM081082

# SPE 475S

## Performance curves

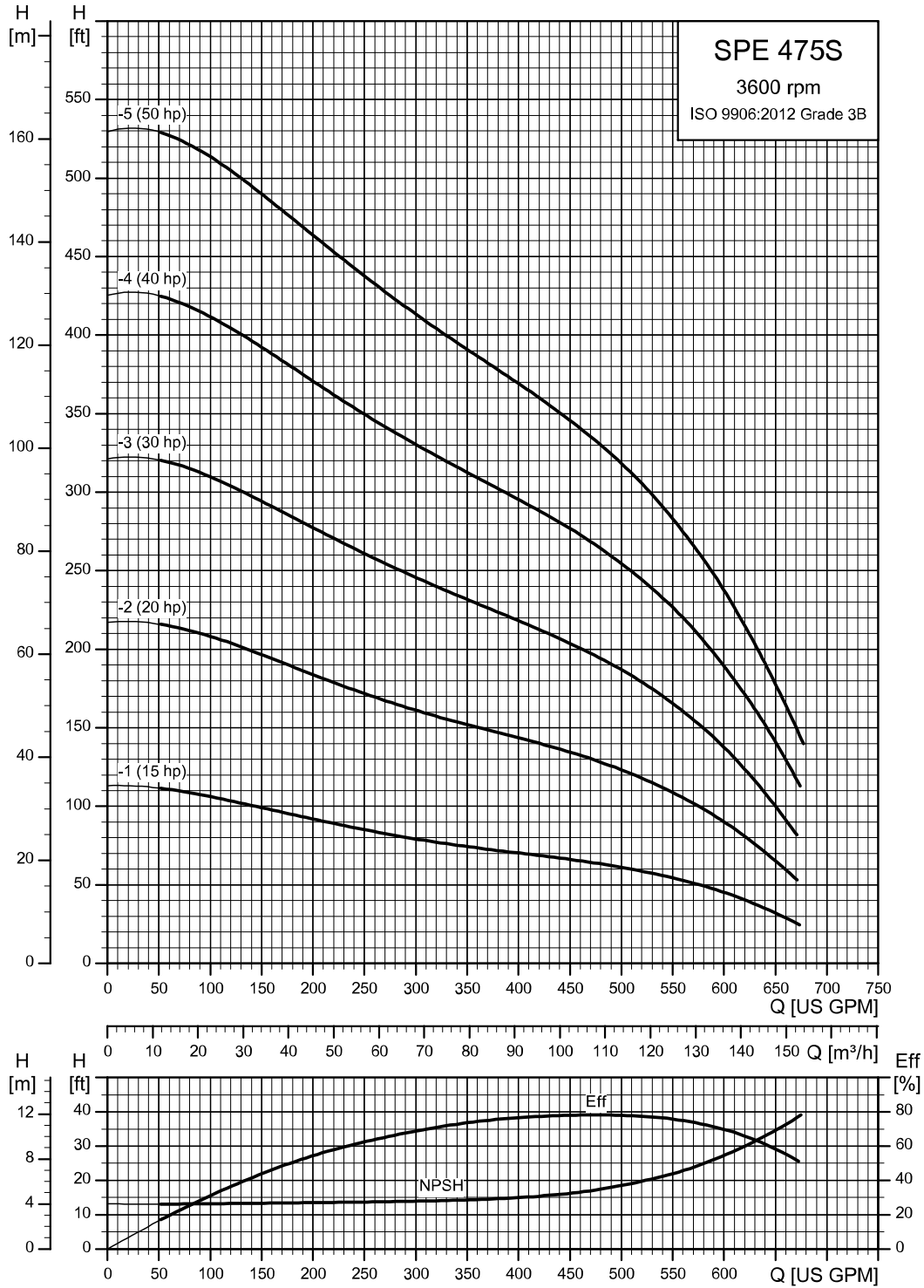

TM081083

## Dimensions and weights

### SPE 475S (475 gpm) pump

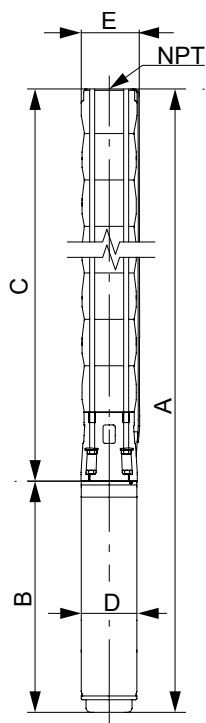

TM081343

| Pump model  | Nom. head [ft] | Motor | Dimensions [in] |       |       |   |      | Net weight (complete) [lb] |
|---|----------------|-------|-----------------|-------|-------|---|------|----------------------------|
|   |                | [Hp]  | A               | B     | C     | D | E    |                            |
| <b>475S, 60 Hz - rated flow rate 475 gpm (6" NPT)</b> |                |       |                 |       |       |   |      |                            |
| SPE 475S-1  | 65             | 15    | 52.56           | 28.23 | 24.33 | 6 | 7.05 | 188.1                      |
| SPE 475S-2  | 132            | 20    | 57.60           | 28.23 | 29.37 | 6 | 7.05 | 197.3                      |
| SPE 475S-3  | 197            | 30    | 68.54           | 34.13 | 34.41 | 6 | 7.05 | 244.3                      |
| SPE 475S-4  | 264            | 40    | 73.58           | 34.13 | 39.45 | 6 | 7.05 | 253.5                      |
| SPE 475S-5  | 331            | 50    | 83.74           | 39.25 | 44.49 | 6 | 7.05 | 291.5                      |

#### Note:

Performance conforms to ISO 9906:2012, Grade 3B.

Minimum submergence is 8 ft.

Power curves

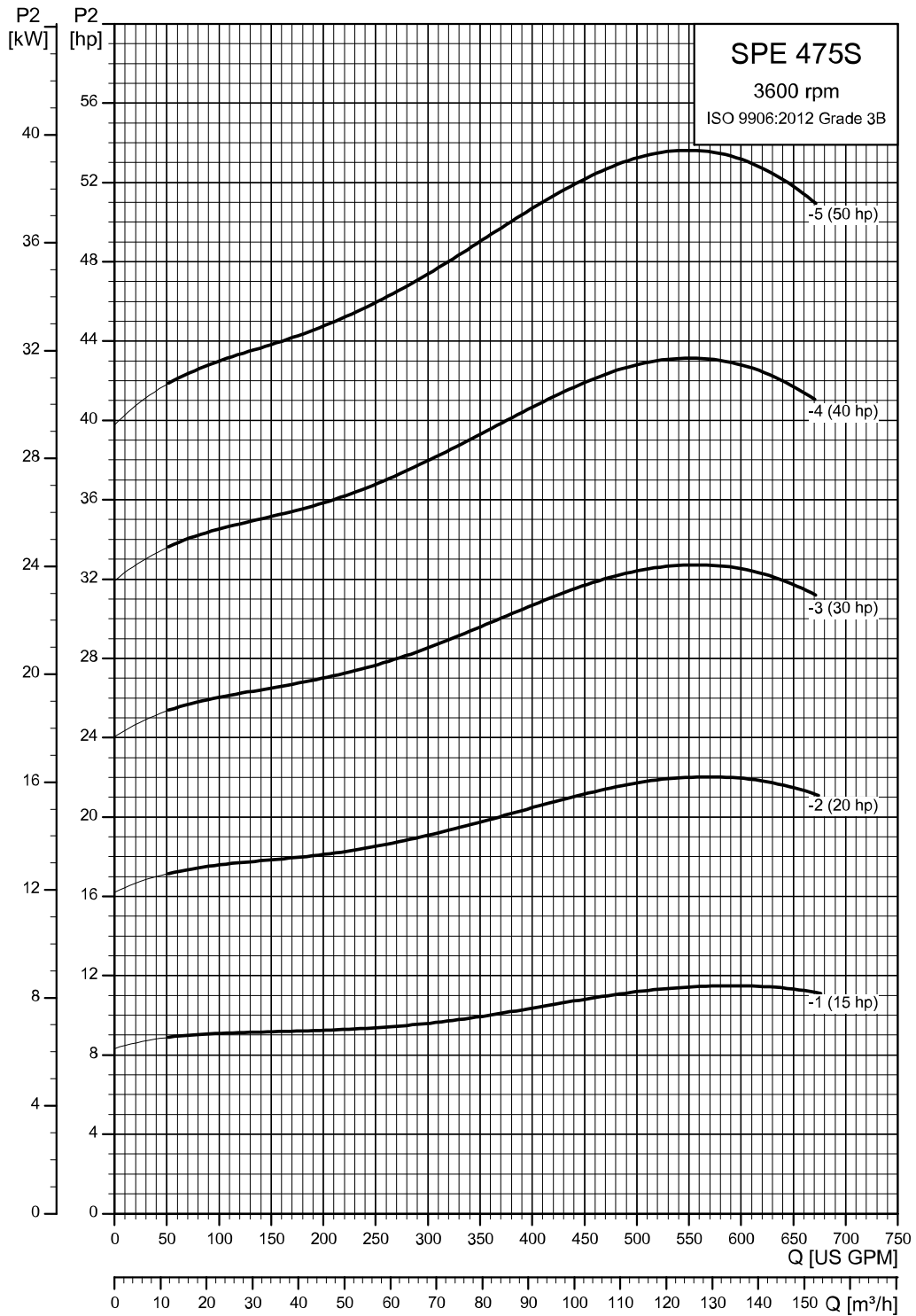

TM081084

# SPE 625S

## Performance curves

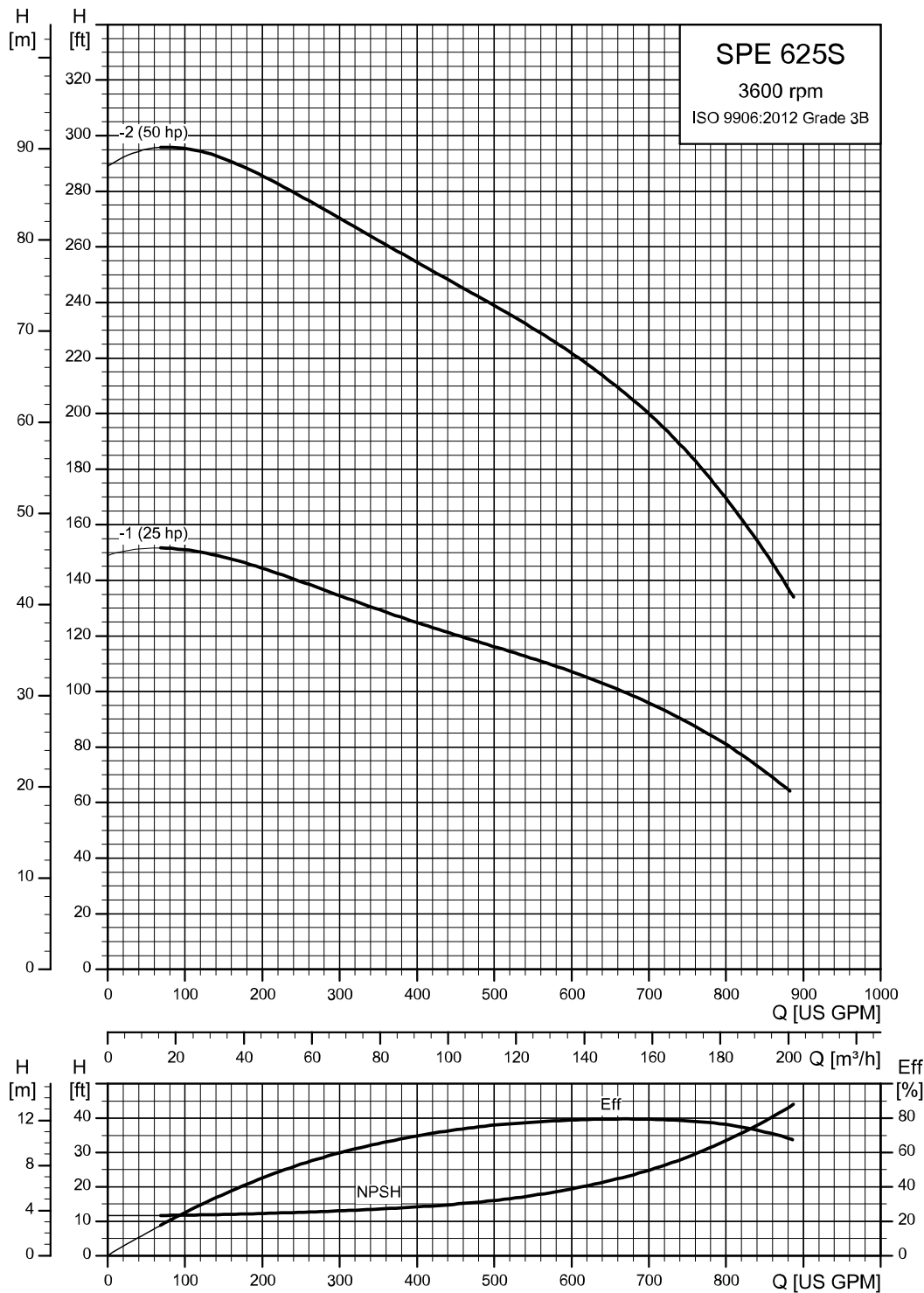

TM081065



## Dimensions and weights

### SPE 625S (625 gpm) pump

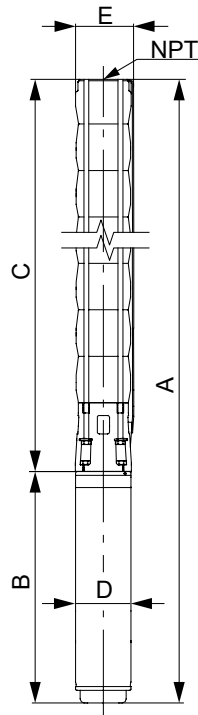

TM081344

| Pump model  | Nom. head [ft] | Motor [Hp] | Dimensions [in] |       |       |   |      | Net weight (complete) [lb] |
|---|----------------|------------|-----------------|-------|-------|---|------|----------------------------|
|   |                |            | A               | B     | C     | D | E    |                            |
| <b>625S, 60 Hz - rated flow rate 625 gpm (6" NPT)</b> |                |            |                 |       |       |   |      |                            |
| SPE 625S-1  | 106            | 25         | 53.88           | 28.23 | 25.65 | 6 | 8.31 | 204.1                      |
| SPE 625S-2  | 212            | 50         | 71.02           | 39.25 | 31.77 | 6 | 8.31 | 283.7                      |

**Note:**

Performance conforms to ISO 9906:2012, Grade 3B.

Minimum submergence is 10 ft.

Power curves

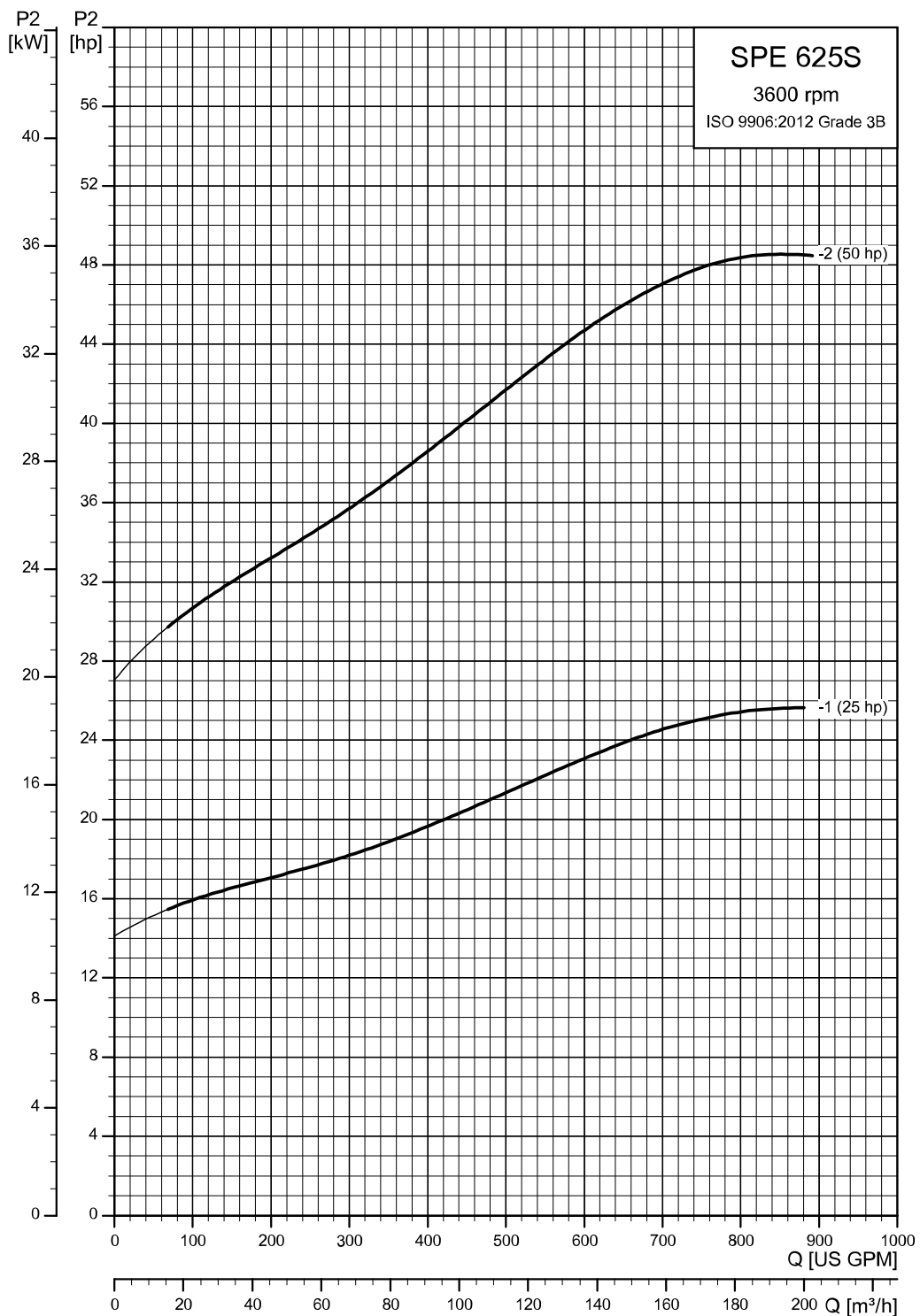

TM081086

# SPE 800S

## Performance curves

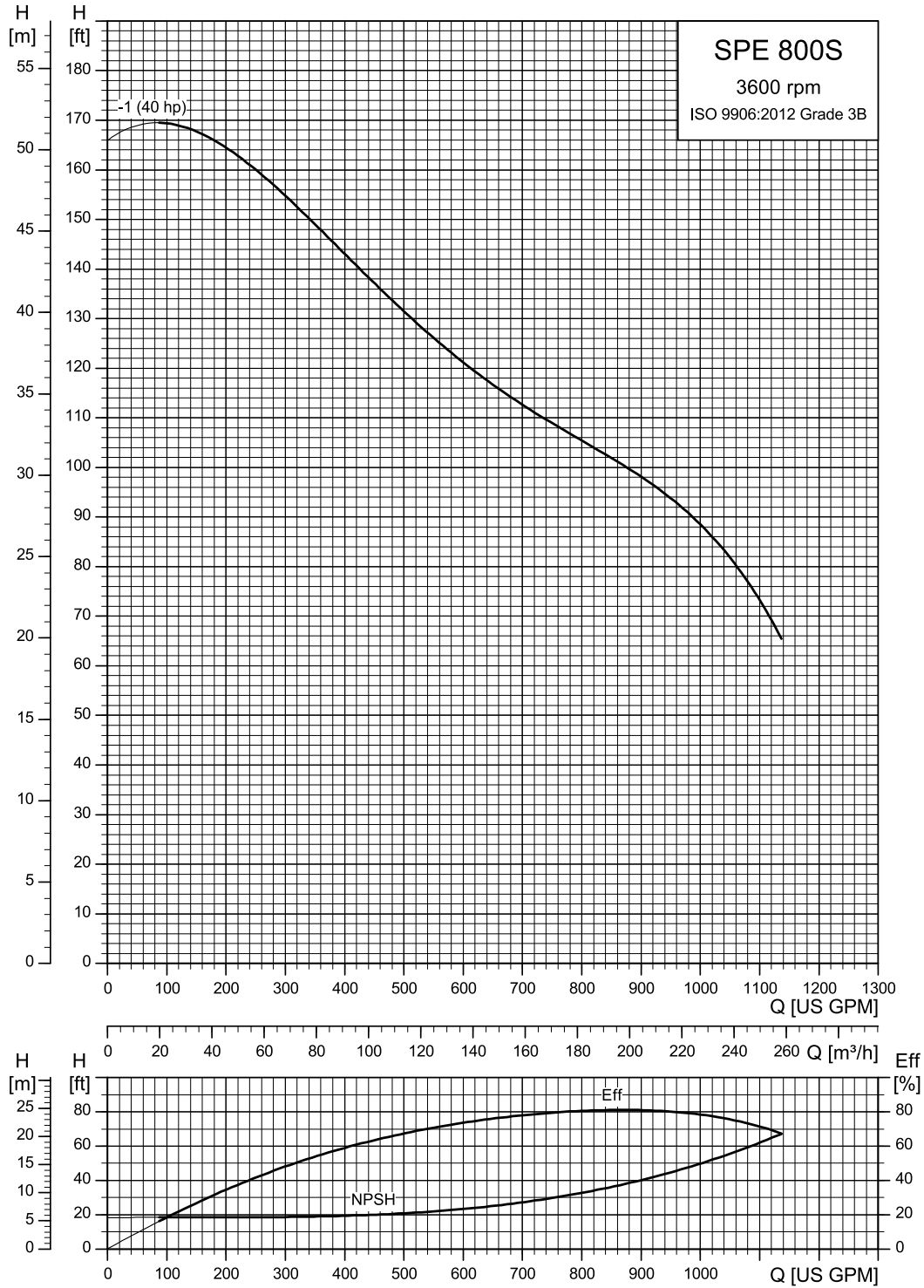

TM081087

## Dimensions and weights

### SPE 800S (800 gpm) pump

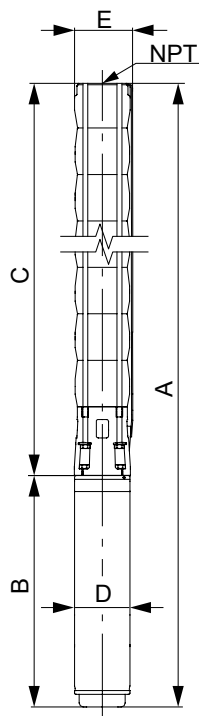

TM081344

| Pump model  | Nom. head [ft] | Motor [Hp] | Dimensions [in] |       |       |   |      | Net weight (complete) [lb] |
|---|----------------|------------|-----------------|-------|-------|---|------|----------------------------|
|   |                |            | A               | B     | C     | D | E    |                            |
| <b>800S, 60 Hz - rated flow rate 800 gpm (6" NPT)</b> |                |            |                 |       |       |   |      |                            |
| SPE 800S-1  | 102            | 30         | 59.78           | 34.13 | 25.65 | 6 | 8.31 | 241.8                      |

**Note:**

Performance conforms to ISO 9906:2012, Grade 3B.

Minimum submergence is 25 ft.

Power curves

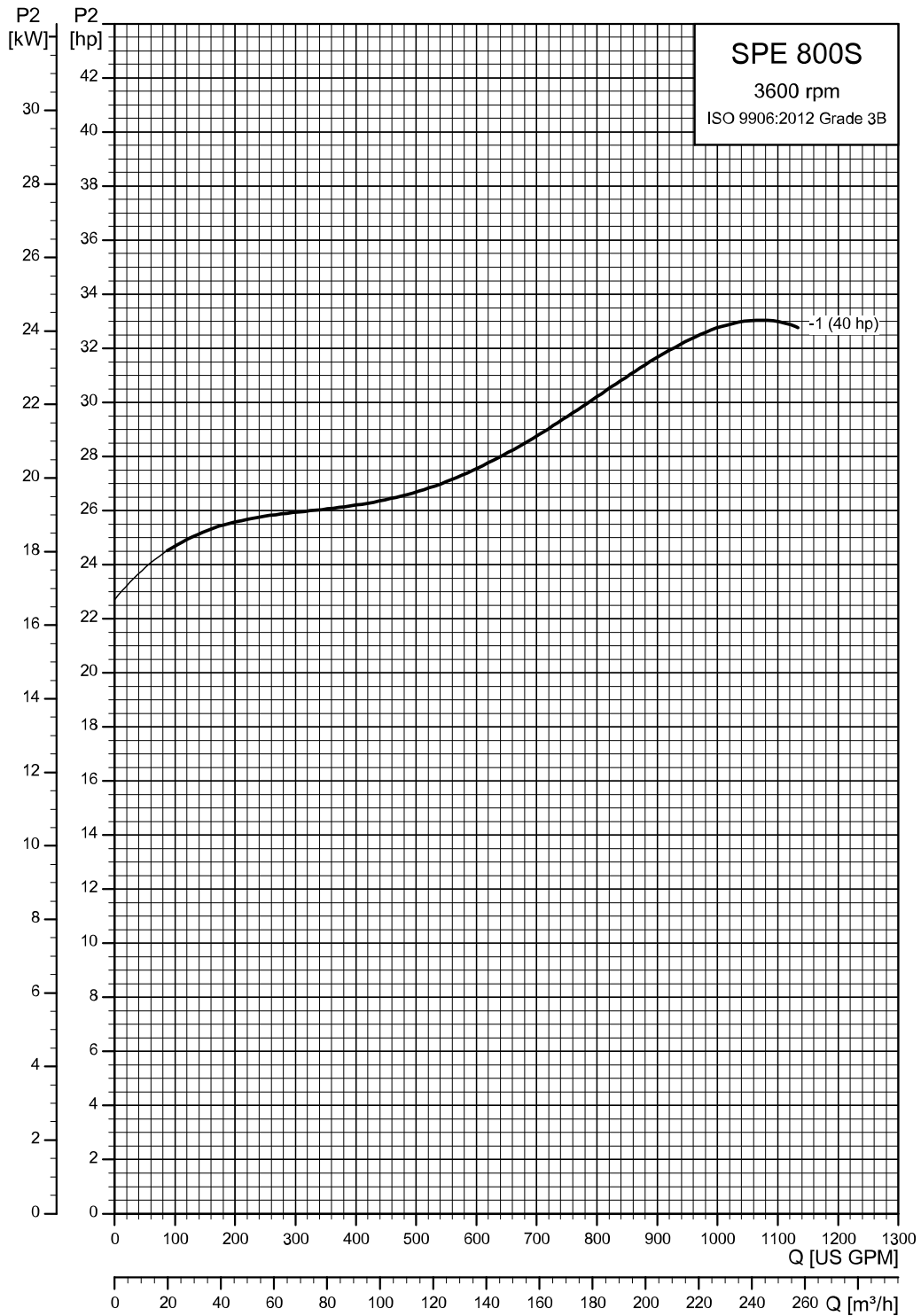

TM081088

# SPE 1100S

## Performance curves

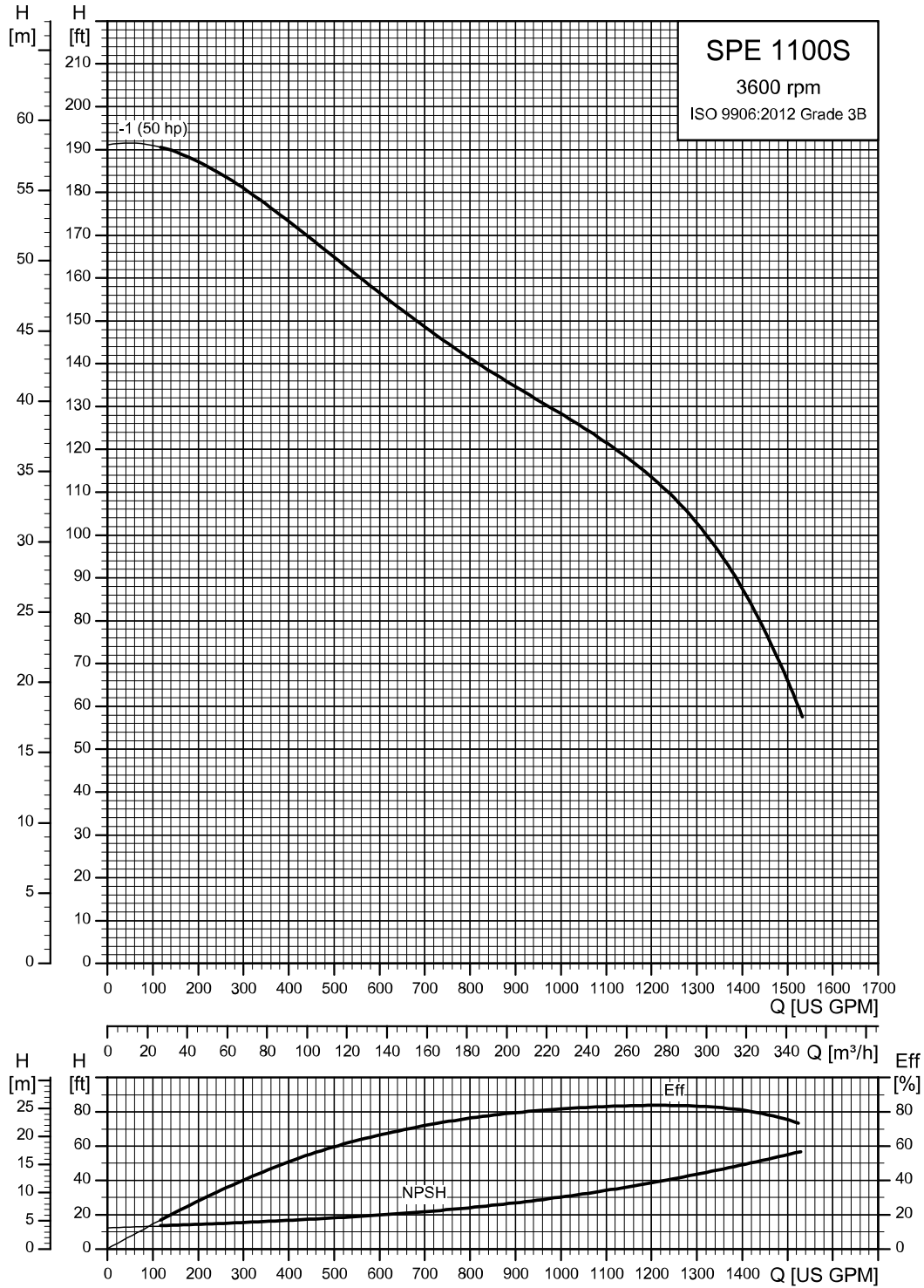

TM081089

## Dimensions and weights

### SPE 1100S (1100 gpm) pump

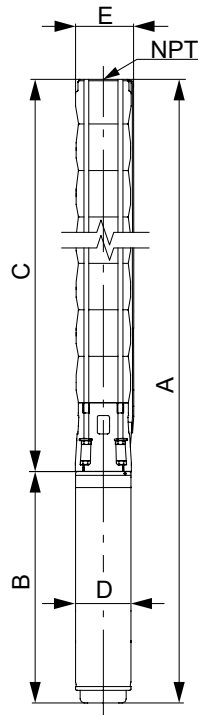

TM081344

| Pump model  | Nom. head [ft] | Motor [Hp] | Dimensions [in] |       |       |   |      | Net weight (complete) [lb] |
|---|----------------|------------|-----------------|-------|-------|---|------|----------------------------|
|   |                |            | A               | B     | C     | D | E    |                            |
| <b>1100S, 60 Hz - rated flow rate 1100 gpm (6" NPT)</b> |                |            |                 |       |       |   |      |                            |
| SPE 1100S-1   | 119            | 50         | 70.35           | 39.25 | 31.10 | 6 | 9.29 | 283.3                      |

**Note:**

Performance conforms to ISO 9906:2012, Grade 3B.

Minimum submergence is 30 ft.

Power curves

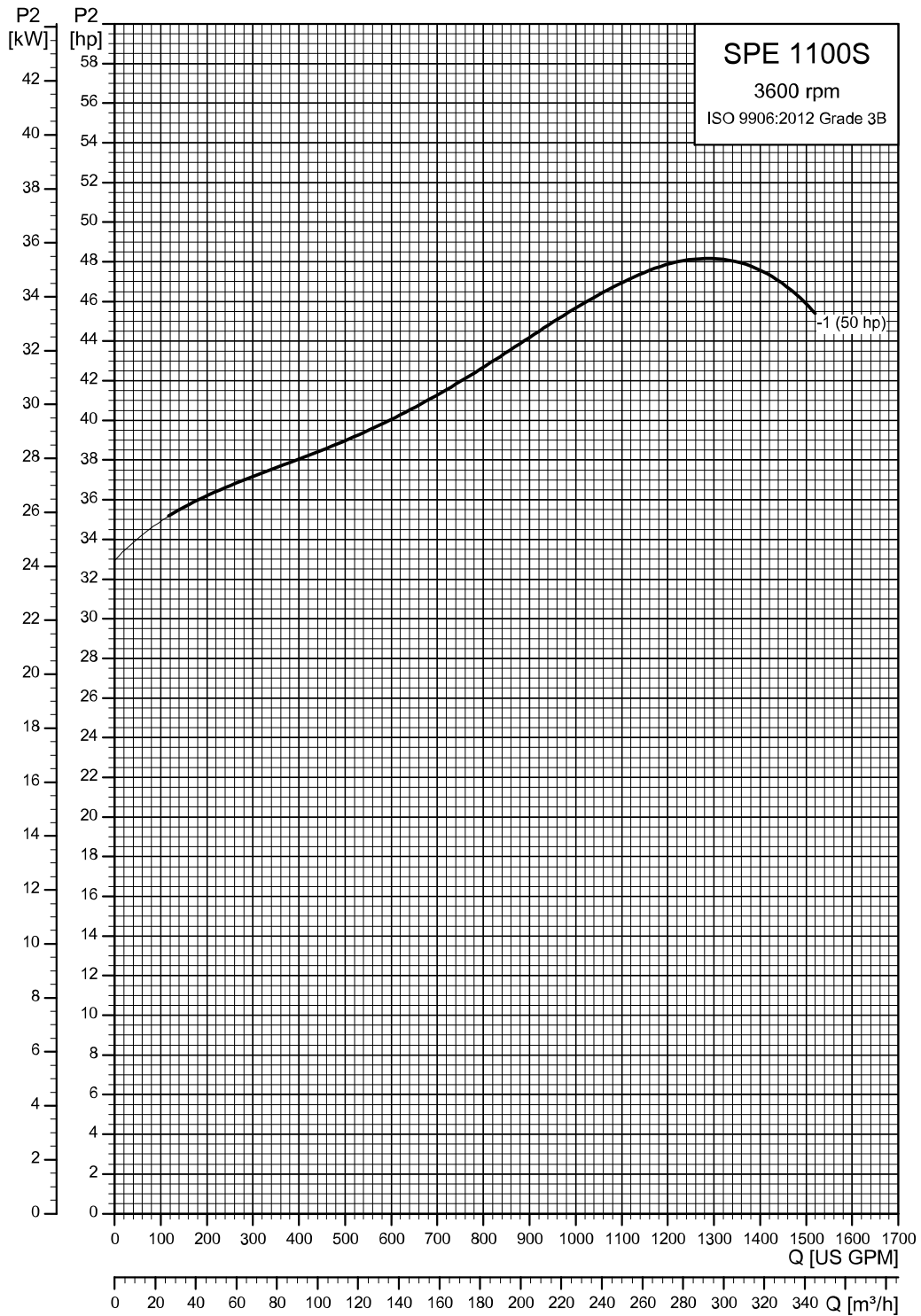

TM081090



## 8. Electrical data

### 3 × 410 V 3600 rpm, MS6000P submersible motor T60

| Power<br>[hp] | Full-load<br>current<br>$I_n$ [A] | Full-load<br>current SF<br>$I_n$ [A] | Motor efficiency<br>[%] |                |                 |              | Power factor          |                       |                        |                     | $I_{st}/I_n$<br>[%] | Build in<br>length<br>[in] | Weight<br>[lbs] |
|---------------|-----------------------------------|--------------------------------------|-------------------------|----------------|-----------------|--------------|-----------------------|-----------------------|------------------------|---------------------|---------------------|----------------------------|-----------------|
|               |                                   |                                      | $\eta$<br>50 %          | $\eta$<br>75 % | $\eta$<br>100 % | $\eta$<br>SF | Cos $\varphi$<br>50 % | Cos $\varphi$<br>75 % | Cos $\varphi$<br>100 % | Cos $\varphi$<br>SF |                     |                            |                 |
| 5.0           | 8.0                               | 8.8                                  | 77.6                    | 83.2           | 86.1            | 87.2         | 0.98                  | 0.97                  | 0.96                   | 0.96                | 100                 | 23.5                       | 81              |
| 7.5           | 11.0                              | 12.4                                 | 83.1                    | 87.0           | 88.8            | 89.4         | 0.97                  | 0.96                  | 0.94                   | 0.92                |                     |                            |                 |
| 10            | 14.4                              | 16.2                                 | 86.2                    | 88.9           | 89.9            | 90.1         | 0.9                   | 0.94                  | 0.90                   | 0.88                |                     |                            |                 |
| 15            | 21.4                              | 24.2                                 | 87.2                    | 90.4           | 91.8            | 92.4         | 0.98                  | 0.96                  | 0.95                   | 0.94                | 100                 | 28.2                       | 108             |
| 20            | 28.2                              | 32.2                                 | 89.8                    | 92.0           | 92.8            | 92.8         | 0.97                  | 0.94                  | 0.92                   | 0.90                |                     |                            |                 |
| 25            | 34.2                              | 39.                                  | 91.0                    | 92.6           | 93.0            | 93.0         | 0.96                  | 0.93                  | 0.90                   | 0.88                |                     |                            |                 |
| 30            | 39.4                              | 44.8                                 | 89.8                    | 92.0           | 92.8            | 93.0         | 0.97                  | 0.94                  | 0.93                   | 0.92                | 100                 | 34.1                       | 141             |
| 40            | 52.6                              | 60.0                                 | 91.6                    | 92.9           | 93.1            | 93.0         | 0.95                  | 0.93                  | 0.91                   | 0.91                |                     |                            |                 |
| 50            | 72.6                              | 82.                                  | 89.9                    | 91.8           | 92.4            | 92.5         | 0.93                  | 0.90                  | 0.87                   | 0.86                |                     |                            |                 |

## 9. Electrical accessories

### Accessories for CUE

#### MCB 114 sensor input module

MCB 114 offers the following additional analog inputs for CUE:

- 1 analog input, 0/4-20 mA
- 2 inputs for Pt100 and Pt1000 temperature sensors.

#### Grundfos Communication Interface Units (CIU)



#### CIU

The CIU enables data communication through open and interoperable networks, such as the following:

- PROFIBUS DP
- PROFINET
- Modbus RTU
- Modbus TPC
- EtherNet/IP
- LON
- BACnet MS/TP
- BACnet IP
- Grundfos Remote Management (GRM) for complete control of pump systems.

#### Applications

Grundfos CIU offers easy installation and commissioning. All units are based on standard functional profiles for an easy integration into the network.

The CIU units enable communication of operating data between pumps and the following:

- PLC
- SCADA system
- Building management system.

#### Benefits

The CIU offers the following benefits:

- open communication standards
- complete process control
- one concept for Grundfos products
- 24-240 VAC/DC power supply in CIU modules
- simple configuration and easy to install
- prepared for DIN rail or wall mounting.

For data communication between an SPE pump and a main network, a CIU unit with a CUE is required.

Fieldbus support for these products is indicated in the table below.

To create a CIU xxx version, a CIU 900 + CIM xxx interface must be ordered.

GRA6118

| CIU unit                 | Fieldbus protocol                   | Product numbers |          |
|--------------------------|-------------------------------------|-----------------|----------|
|                          |                                     | CIU 900         | CIM      |
| CIU 100                  | LON                                 |                 | 96824797 |
| CIU 150                  | PROFIBUS DP                         |                 | 96824793 |
| CIU 200                  | Modbus RTU                          |                 | 96824796 |
| CIU 260-EU <sup>4)</sup> | 3G/4G cellular                      |                 | 99439302 |
| CIU 280-EU <sup>5)</sup> | Grundfos iSOLUTIONS Cloud/GRM 3G/4G | 99448387        | 99439724 |
| CIU 300                  | BACnet MS/TP                        |                 | 96893770 |
|                          | PROFINET                            |                 |          |
| CIU 500                  | Modbus TCP                          |                 |          |
|                          | BACnet IP                           |                 | 98301408 |
|                          | EtherNet/IP                         |                 |          |
|                          | GRM IP                              |                 |          |

<sup>4)</sup> Requires an antenna kit.

<sup>5)</sup> Grundfos Remote Management (GRM) is an easy-to-install, low-cost solution for wireless monitoring and management of Grundfos products. It requires an antenna kit. 3G/4G SIM card must have additional international PDU SMS roaming active.

#### Antennas for CIU 260 and 280

| Description | Product number |
|-------------|----------------|
| Antenna kit | 99518079       |

## Pt100 and accessories

| Pt100 sensor, including cable for standard-, N- and R-versions                    | Cable length [ft] | Product number |
|---|-------------------|----------------|
|  | 60                | 96913237       |
|   | 120               | 96913253       |
|   | 180               | 96913256       |
|   | 240               | 96913260       |
|   | 300               | 96913263       |

GRA3190

| Staybolt kits for Pt100   | Description  | Product number |
|---|--|----------------|
|  | Staybolt kit for Pt100.<br>Material: EN 1.4401/AISI 316. | 97550639       |
|   | Staybolt kit for Pt100.<br>Material: EN 1.4539/AISI 90L. | 96803373       |

GRA3191

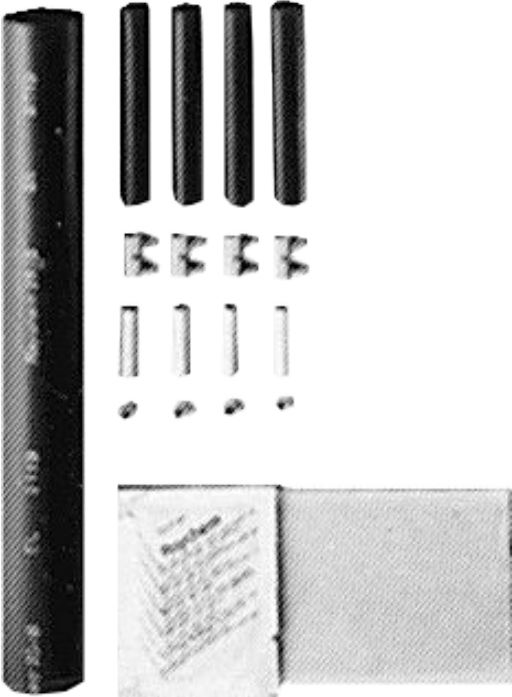
| Extension kit for sensor cable for Pt100   | Description   | Product number |
|--|---|----------------|
|  | Extension kit for Pt100 sensor cable.<br>For watertight shrink-joining of the sensor cable.<br>Extra sensor cable must be ordered separately. | 99039717       |

TMC07885

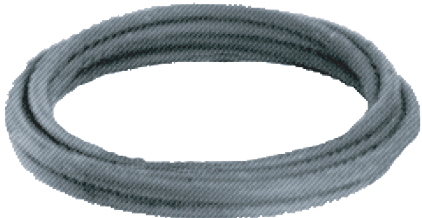
| Sensor cable  | Description   | Product number |
|---|---|----------------|
|  | Drop cable for extension: $4 \times 0.0015 \text{ in}^2$<br>Mention length when ordering.<br>Maximum recommended length: 1150 ft. | 00RM5271       |

TMC07882

## 10. Mechanical accessories

### Connecting pieces / Adaptors

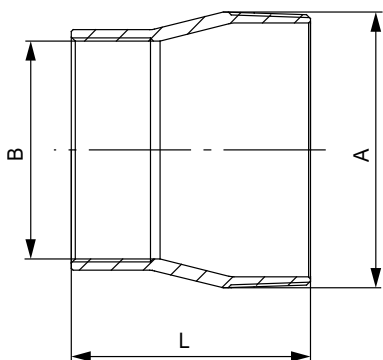

TM012397



GRA2555

Dimensional sketch and photo of connecting piece thread-to-thread

| Type  | Connecting piece | Dimensions       |       |           | Product number      |                     |
|-------|------------------|------------------|-------|-----------|---------------------|---------------------|
|       |                  | Thread-to-thread |       | L<br>[in] | 304 stainless steel | 316 stainless steel |
|       |                  | A                | B     |           |                     |                     |
| 385S  | NPT 5 → NPT 4    | NPT 5            | NPT 4 | 4.76      | 190064              | 190586              |
| 475S  | NPT 5 → NPT 6    | NPT 5            | NPT 6 | 5.91      | 190070              | 190592              |
| 625S  |                  |                  |       |           |                     |                     |
| 800S  | NPT 6 → NPT 5    | NPT 6            | NPT 5 | 5.91      | 200135              | 200645              |
| 1100S |                  |                  |       |           |                     |                     |

## Zinc anodes

### Application

Cathodic protection by zinc can be used for corrosion protection of SP pumps in chloride-containing liquids, such as brackish water and seawater.

Sacrificial anodes are placed on the outside of the pump and motor as protection against corrosion. See the figure below.

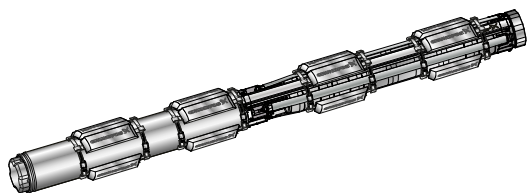

TM078808

Submersible motor fitted with anode strings

More information about zinc anode and product numbers are available in **SP accessories data booklet**.

## Flow sleeves

Grundfos offers a complete range of stainless-steel flow sleeves for both vertical and horizontal operation. Flow sleeves are recommended for all applications in which motor cooling is insufficient. The result is a general extension of motor lifespan. Flow sleeves are to be fitted in the following cases:

- If the submersible pump is exposed to a high thermal load such, as current unbalance, dry running, overload, high ambient temperature, and bad cooling conditions.
- If aggressive liquids are pumped, since corrosion is doubled for every 18 °F the temperature rises.
- If sedimentation or deposits occur around and/or on the motor.

More information about flow sleeves and product numbers are available in SPE accessories data booklet and on Grundfos Product Center.

<https://product-selection.grundfos.com>.



TM010750



TM010751

Flow sleeves

### Example of a calculated flow sleeve

The flow sleeve is fitted to the submersible motor so that the liquid passes close by the motor on its way towards the pump suction interconnector, ensuring optimum motor cooling. See the figure below.

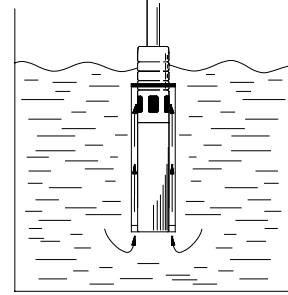

TM010509

### Flow sleeve function

The flow sleeve is designed so that the flow velocity past the motor is minimum 1.6 ft/s and maximum 10 ft/s to ensure optimum pump operating conditions.

Use the following formula to calculate the flow velocity:

|     |      |                                    |        |
|-----|------|------------------------------------|--------|
| $V$ | =    | $\frac{Q \times 0.125}{D^2 - d^2}$ | [ft/s] |
| Q   | GPM  | Flow rate                          |        |
| D   | inch | Sleeve diameter                    |        |
| d   | inch | Pump diameter                      |        |

## 11. Cable sizing

### Cable dimensions at 3 × 410 V, 120 Hz motor supply, valid for AWG and MCM cables

| Maximum submersible power cable length at 86 °F ambient temperature and a maximum conductor temperature of 140 °F |                         |     |      |      |      |      |      |      |      |      |      |                              |      |      |      |      |
|---|-------------------------|-----|------|------|------|------|------|------|------|------|------|------------------------------|------|------|------|------|
| Motor rating<br>[hp]  | AWG copper wire<br>[ft] |     |      |      |      |      |      |      |      |      |      | MCM copper wire size<br>[ft] |      |      |      |      |
|   | 14                      | 12  | 10   | 8    | 6    | 4    | 3    | 2    | 1    | 0    | 00   | 000                          | 0000 | 250  | 300  | 40   |
| 5   | 484                     | 763 | 1215 | 1915 | 3035 | 4758 | 5950 | 7410 | 9235 | -    | -    | -                            | -    | -    | -    | -    |
| 7.5   | 354                     | 559 | 888  | 1399 | 2212 | 3458 | 4316 | 5361 | 6661 | 8224 | -    | -                            | -    | -    | -    | -    |
| 10  | 284                     | 448 | 713  | 1124 | 1782 | 2796 | 3498 | 4359 | 5437 | 6744 | 8350 | -                            | -    | -    | -    | -    |
| 15  | -                       | 284 | 451  | 711  | 1127 | 1766 | 2208 | 2749 | 3426 | 4244 | 5247 | 6438                         | 7869 | 9075 | -    | -    |
| 20  | -                       | -   | -    | 563  | 890  | 1390 | 1734 | 2152 | 2672 | 3296 | 4054 | 4944                         | 5998 | 6874 | 7900 | 9757 |
| 25  | -                       | -   | -    | 466  | 737  | 1154 | 1441 | 1792 | 2229 | 2757 | 3401 | 4162                         | 5070 | 5832 | 6730 | 8374 |
| 30  | -                       | -   | -    | -    | 620  | 971  | 1212 | 1507 | 1874 | 2318 | 2858 | 3496                         | 4257 | 4894 | 5645 | 7018 |
| 40  | -                       | -   | -    | -    | -    | 728  | 907  | 1126 | 1396 | 1721 | 2114 | 2574                         | 3118 | 3569 | 4095 | 5043 |
| 50  | -                       | -   | -    | -    | -    | -    | 687  | 851  | 1054 | 1297 | 1590 | 1932                         | 2334 | 2666 | 3051 | 3741 |

Note:

1. The table is based on a jacketed, 4-lead copper wire.
2. The maximum permissible temperature of the conductor is 140 °F.
3. Make sure that the portion of the total cable, which is between the service entrance and a motor starter/controller, does not exceed 25 % of the total maximum length to ensure reliable starter operation.
4. The table is based on a maintaining motor terminal voltage at 95 % of service entrance voltage, running at the maximum current stated on the nameplate.

| Maximum submersible power cable length at 86 °F ambient temperature and a maximum conductor temperature of 167 °F |                         |     |      |      |      |      |      |      |      |      |      |                              |      |      |      |      |
|---|-------------------------|-----|------|------|------|------|------|------|------|------|------|------------------------------|------|------|------|------|
| Motor rating<br>[hp]  | AWG copper wire<br>[ft] |     |      |      |      |      |      |      |      |      |      | MCM copper wire size<br>[ft] |      |      |      |      |
|   | 14                      | 12  | 10   | 8    | 6    | 4    | 3    | 2    | 1    | 0    | 00   | 000                          | 0000 | 250  | 300  | 40   |
| 5   | 484                     | 763 | 1215 | 1915 | 3035 | 4758 | 5950 | 7410 | 9235 | -    | -    | -                            | -    | -    | -    | -    |
| 7.5   | 354                     | 559 | 888  | 1399 | 2212 | 3458 | 4316 | 5361 | 6661 | 8224 | -    | -                            | -    | -    | -    | -    |
| 10  | 284                     | 448 | 713  | 1124 | 1782 | 2796 | 3498 | 4359 | 5437 | 6744 | 8350 | -                            | -    | -    | -    | -    |
| 15  | -                       | 284 | 451  | 711  | 1127 | 1766 | 2208 | 2749 | 3426 | 4244 | 5247 | 6438                         | 7869 | 9075 | -    | -    |
| 20  | -                       | -   | 357  | 563  | 890  | 1390 | 1734 | 2152 | 2672 | 3296 | 4054 | 4944                         | 5998 | 6874 | 7900 | 9757 |
| 25  | -                       | -   | -    | 466  | 737  | 1154 | 1441 | 1792 | 2229 | 2757 | 3401 | 4162                         | 5070 | 5832 | 6730 | 8374 |
| 30  | -                       | -   | -    | 392  | 620  | 971  | 1212 | 1507 | 1874 | 2318 | 2858 | 3496                         | 4257 | 4894 | 5645 | 7018 |
| 40  | -                       | -   | -    | -    | 466  | 728  | 907  | 1126 | 1396 | 1721 | 2114 | 2574                         | 3118 | 3569 | 4095 | 5043 |
| 50  | -                       | -   | -    | -    | -    | 551  | 687  | 851  | 1054 | 1297 | 1590 | 1932                         | 2334 | 2666 | 3051 | 3741 |

## Note:

1. The table is based on a jacketed, 4-lead copper wire.
2. The maximum permissible temperature of the conductor is 167 °F.
3. Make sure that the portion of the total cable, which is between the service entrance and a motor starter/controller, does not exceed 25 % of the total maximum length to ensure reliable starter operation.
4. The table is based on a maintaining motor terminal voltage at 95 % of service entrance voltage, running at the maximum current stated on the nameplate.

## 12. Head loss

### Friction loss tables

|  |          | SCH 40 steel pipe |           |           |           |           |           |           |           |           |
|--|----------|-------------------|-----------|-----------|-----------|-----------|-----------|-----------|-----------|-----------|
| [US gpm]   | [US gph] | .5"               | .75"      | 1"        | 1.25"     | 1.5"      | 2"        | 2.5"      | 3"        | 4"        |
|  |          | ID 0.622"         | ID 0.824" | ID 1.049" | ID 1.380" | ID 1.610" | ID 2.067" | ID 2.469" | ID 3.068" | ID 4.026" |
| Friction loss in feet of head per 100 feet of pipe |          |                   |           |           |           |           |           |           |           |           |
| 2  | 120      | 4.8               |           |           |           |           |           |           |           |           |
| 3  | 180      | 10.0              | 2.5       |           |           |           |           |           |           |           |
| 4  | 240      | 17.1              | 4.2       |           |           |           |           |           |           |           |
| 5  | 300      | 25.8              | 6.3       | 1.9       |           |           |           |           |           |           |
| 6  | 360      | 36.5              | 8.9       | 2.7       |           |           |           |           |           |           |
| 7  | 420      | 48.7              | 11.8      | 3.6       |           |           |           |           |           |           |
| 8  | 480      | 62.7              | 15.0      | 4.5       |           |           |           |           |           |           |
| 9  | 540      | 78.3              | 18.8      | 5.7       |           |           |           |           |           |           |
| 10   | 600      | 95.9              | 23.0      | 6.9       |           |           |           |           |           |           |
| 12   | 720      |                   | 32.6      | 9.6       | 2.5       | 1.2       |           |           |           |           |
| 14   | 840      |                   | 43.5      | 12.8      | 3.3       | 1.5       |           |           |           |           |
| 16   | 960      |                   | 56.3      | 16.5      | 4.2       | 2.0       |           |           |           |           |
| 20   | 1,200    |                   | 86.1      | 25.1      | 6.3       | 2.9       |           |           |           |           |
| 25   | 1,500    |                   |           | 38.7      | 9.6       | 4.5       | 1.3       |           |           |           |
| 30   | 1,800    |                   |           | 54.6      | 13.6      | 6.3       | 1.8       |           |           |           |
| 35   | 2,100    |                   |           | 73.3      | 18.2      | 8.4       | 2.4       |           |           |           |
| 40   | 2,400    |                   |           | 95.0      | 23.5      | 10.8      | 3.1       | 1.3       |           |           |
| 45   | 2,700    |                   |           |           | 29.4      | 13.5      | 3.9       | 1.6       |           |           |
| 50   | 3,000    |                   |           |           | 36.0      | 16.4      | 4.7       | 1.9       |           |           |
| 60   | 3,600    |                   |           |           | 51.0      | 23.2      | 6.6       | 2.7       |           |           |
| 70   | 4,200    |                   |           |           | 68.8      | 31.3      | 8.9       | 3.6       | 1.2       |           |
| 80   | 4,800    |                   |           |           | 89.2      | 40.5      | 11.4      | 4.6       | 1.6       |           |
| 90   | 5,400    |                   |           |           |           | 51.0      | 14.2      | 5.8       | 2.0       |           |
| 100  | 6,000    |                   |           |           |           | 62.2      | 17.4      | 7.1       | 2.4       |           |
| 120  | 7,200    |                   |           |           |           |           | 24.7      | 10.1      | 3.4       |           |
| 140  | 8,400    |                   |           |           |           |           | 33.2      | 13.5      | 4.5       | 1.2       |
| 160  | 9,600    |                   |           |           |           |           | 43.0      | 17.5      | 5.8       | 1.5       |
| 200  | 12,000   |                   |           |           |           |           | 66.3      | 27.0      | 8.9       | 2.3       |
| 260  | 15,600   |                   |           |           |           |           |           | 45.0      | 14.8      | 3.7       |
| 300  | 18,000   |                   |           |           |           |           |           | 59.6      | 19.5      | 4.9       |



|  |          | SCH 40 PVC pipe |           |           |           |           |           |           |           |           |
|--|----------|-----------------|-----------|-----------|-----------|-----------|-----------|-----------|-----------|-----------|
| [US gpm]   | [US gph] | .5"             | .75"      | 1"        | 1.25"     | 1.5"      | 2"        | 2.5"      | 3"        | 4"        |
|  |          | ID 0.622"       | ID 0.824" | ID 1.049" | ID 1.380" | ID 1.610" | ID 2.067" | ID 2.469" | ID 3.068" | ID 4.026" |
| Friction loss in feet of head per 100 feet of pipe |          |                 |           |           |           |           |           |           |           |           |
| 2  | 120      | 4.1             |           |           |           |           |           |           |           |           |
| 3  | 180      | 8.7             | 2.2       |           |           |           |           |           |           |           |
| 4  | 240      | 14.8            | 3.7       |           |           |           |           |           |           |           |
| 5  | 300      | 22.2            | 5.7       | 1.8       |           |           |           |           |           |           |
| 6  | 360      | 31.2            | 8.0       | 2.5       |           |           |           |           |           |           |
| 7  | 420      | 41.5            | 10.6      | 3.3       |           |           |           |           |           |           |
| 8  | 480      | 53.0            | 13.5      | 4.2       |           |           |           |           |           |           |
| 9  | 540      | 66.0            | 16.8      | 5.2       |           |           |           |           |           |           |
| 10   | 600      | 80.5            | 20.4      | 6.3       | 1.7       |           |           |           |           |           |
| 12   | 720      |                 | 28.6      | 8.9       | 2.3       | 1.1       |           |           |           |           |
| 14   | 840      |                 | 38.0      | 11.8      | 3.1       | 1.4       |           |           |           |           |
| 16   | 960      |                 | 48.6      | 15.1      | 4.0       | 1.9       |           |           |           |           |
| 20   | 1,200    |                 | 60.5      | 22.8      | 6.0       | 2.8       |           |           |           |           |
| 25   | 1,500    |                 |           | 38.7      | 9.1       | 4.3       | 1.3       |           |           |           |
| 30   | 1,800    |                 |           |           | 12.7      | 6.0       | 1.8       |           |           |           |
| 35   | 2,100    |                 |           |           | 16.9      | 8.0       | 2.4       |           |           |           |
| 40   | 2,400    |                 |           |           | 21.6      | 10.2      | 3.0       | 1.1       |           |           |
| 45   | 2,700    |                 |           |           | 28.0      | 12.5      | 3.8       | 1.4       |           |           |
| 50   | 3,000    |                 |           |           |           | 15.4      | 4.6       | 1.7       |           |           |
| 60   | 3,600    |                 |           |           |           | 21.6      | 6.4       | 2.3       |           |           |
| 70   | 4,200    |                 |           |           |           | 28.7      | 8.5       | 3.0       | 1.2       |           |
| 80   | 4,800    |                 |           |           |           | 36.8      | 10.9      | 3.8       | 1.4       |           |
| 90   | 5,400    |                 |           |           |           | 45.7      | 13.6      | 4.8       | 1.8       |           |
| 100  | 6,000    |                 |           |           |           | 56.6      | 16.5      | 5.7       | 2.2       |           |
| 120  | 7,200    |                 |           |           |           |           | 23.1      | 8.0       | 3.0       |           |
| 140  | 8,400    |                 |           |           |           |           | 30.6      | 10.5      | 4.0       | 1.1       |
| 160  | 9,600    |                 |           |           |           |           | 39.3      | 13.4      | 5.0       | 1.4       |
| 200  | 12,000   |                 |           |           |           |           | 66.3      | 20.1      | 7.6       | 2.1       |
| 260  | 15,600   |                 |           |           |           |           |           | 32.4      | 12.2      | 3.4       |
| 300  | 18,000   |                 |           |           |           |           |           | 42.1      | 15.8      | 4.4       |

**Note:**

Based on Schedule 40 steel and plastic fittings.

Friction loss figures are for screwed valves and are based on equivalent lengths of steel pipe.

## 13. Grundfos Product Center

Online search and sizing tool to help you make the right choice.

From the international view, you can select your specific country to view the product range available to you.

International view: <https://product-selection.grundfos.com>

### All the information you need in one place

Performance curves, technical specifications, pictures, dimensional drawings, motor curves, wiring diagrams, spare parts, service kits, 3D drawings, documents, system parts. The Product Center displays any recent and saved items - including complete projects - right on the main page.

### Downloads

On the product pages, you can download installation and operating instructions, data booklets, service instructions, etc., in PDF format.

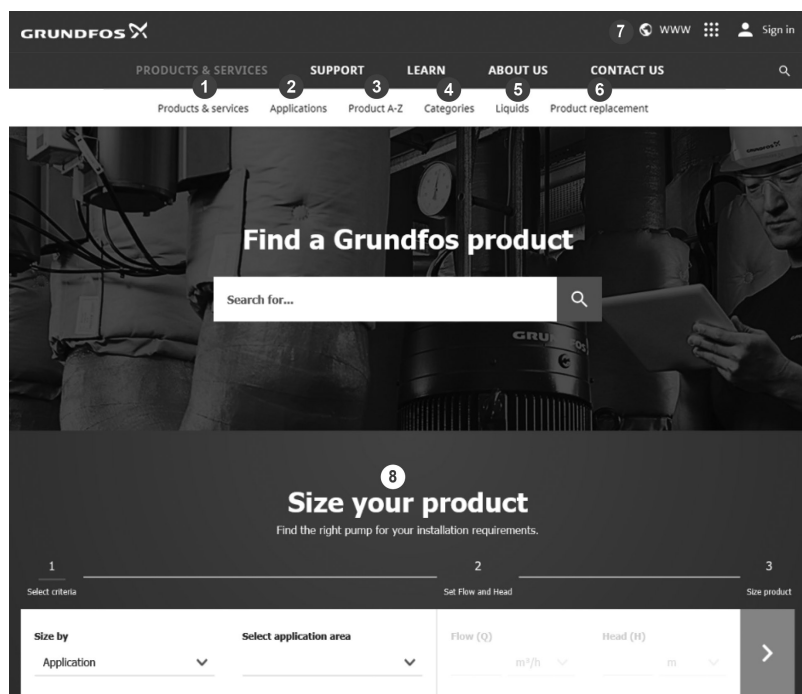

When you select your country, you will see the menus below. Note that some menus may not be available depending on the country.

Example: <https://product-selection.grundfos.com/uk>

| Pos. | Description   |
|------|---|
| 1    | <b>Products &amp; services</b> enables you to find products and documents by typing a product number or name into the search field.     |
| 2    | <b>Applications</b> enables you to choose an application to see how Grundfos can help you design and optimize your system.              |
| 3    | <b>Products A-Z</b> enables you to look through a list of all the Grundfos products.  |
| 4    | <b>Categories</b> enables you to look for a product category.   |
| 5    | <b>Liquids</b> enables you to find pumps designed for aggressive, flammable or other special liquids.                                   |
| 6    | <b>Product replacement</b> enables you to find a suitable replacement.  |
| 7    | <b>WWW</b> enables you to select the country, which changes the language, the available product range and the structure of the website. |
| 8    | <b>Sizing</b> enables you to size a product based on your application and operating conditions.   |

## 14. Document quality feedback

To provide feedback about this document, scan the QR code using your phone's camera or a QR code app.



FEEDBACK92661369

[Click here to submit your feedback](#)

92661369 12.2024

ECM: 1390433

**GRUNDFOS Holding A/S**  
Poul Due Jensens Vej 7  
DK-8850 Bjerringbro  
Tel: +45 87 50 14 00  
[www.grundfos.com](http://www.grundfos.com)

**GRUNDFOS** 