

# NBS, NBSE

Fixed speed range

Speed-controlled, non-sensor range

Speed-controlled, Series 2000, 2-channel sensor range

Single-stage end-suction pumps with split coupled design

60 Hz - ANSI

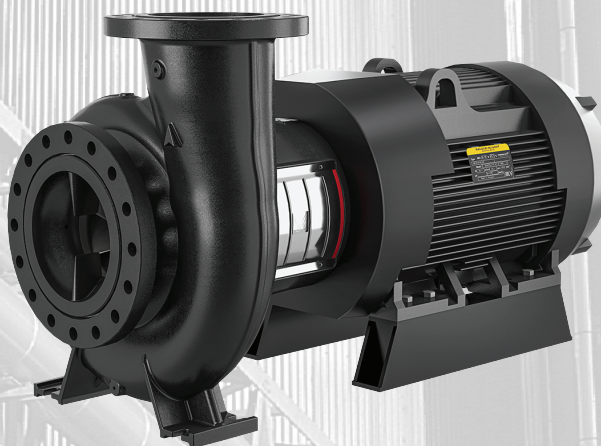
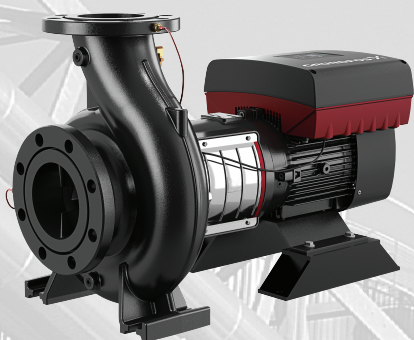

<b>1. Applications</b> . . . . .	<b>4</b>	<b>9. Speed-controlled pumps</b> . . . . .	<b>48</b>
Introduction . . . . .	4	E-pumps in connection with a CUE . . . . .	48
Water supply . . . . .	4	Why select an E-pump. . . . .	49
Industrial pressure boosting . . . . .	4	Maximum speed of the impeller . . . . .	49
Industrial liquid transfer . . . . .	4	Affinity equations . . . . .	50
HVAC . . . . .	5	Communication with the E-solution . . . . .	51
Irrigation . . . . .	5	Communication with E-pumps . . . . .	53
<b>2. Features and benefits</b> . . . . .	<b>6</b>	<b>10. Pumps connected in parallel.</b> . . . . .	<b>54</b>
Features . . . . .	6	Control of pumps connected in parallel . . . . .	54
Benefits . . . . .	6	Pumps connected to Control MPC . . . . .	54
<b>3. Performance range</b> . . . . .	<b>8</b>	<b>11. Selection of product</b> . . . . .	<b>55</b>
NBSE full range . . . . .	8	Pump size . . . . .	55
NBSE medium speed . . . . .	9	Efficiency . . . . .	55
NBSE low speed. . . . .	10	Material . . . . .	55
NBS, 2-pole . . . . .	11	<b>12. Pumped liquids</b> . . . . .	<b>56</b>
NBS, 4-pole . . . . .	12	<b>13. Pump flange dimensions.</b> . . . . .	<b>57</b>
NBS, 6-pole . . . . .	13	Fixed pump flanges, ASME/ANSI B16.1. . . . .	57
<b>4. Product range.</b> . . . . .	<b>14</b>	Loose pump flanges, ASME/ANSI B16.42 . . . . .	57
NBSE, medium speed/NBS, 2-pole . . . . .	15	<b>14. Introduction to curves and technical data</b> . . . . .	<b>58</b>
NBSE, low speed/NBS, 4-pole . . . . .	18	How to read the curve charts . . . . .	58
NBS, 6-pole . . . . .	22	Curve conditions . . . . .	59
E-pumps . . . . .	24	Pump performance testing . . . . .	59
<b>5. Identification.</b> . . . . .	<b>25</b>	Performance-test types . . . . .	61
Nameplate . . . . .	25	Specifying acceptance grades . . . . .	62
Type key . . . . .	26	<b>15. Performance curves.</b> . . . . .	<b>64</b>
<b>6. Construction.</b> . . . . .	<b>29</b>	Overview . . . . .	64
NBS, center-line outlet. . . . .	29	Medium speed, 4000 RPM . . . . .	66
NBS, tangential outlet . . . . .	29	Low speed, 2000 - 2200 RPM . . . . .	71
Material specification, NBS. . . . .	30	2-pole . . . . .	83
Mechanical construction . . . . .	32	4-pole . . . . .	89
Surface treatment . . . . .	34	6-pole . . . . .	105
Test pressure . . . . .	34	<b>16. Dimensional drawings and technical data</b> . . . . .	<b>116</b>
Motors and drives . . . . .	34	Dimensional drawings, NBSE . . . . .	116
<b>7. Operating conditions</b> . . . . .	<b>38</b>	Dimensions for NBSE pumps (460 V) . . . . .	117
Ambient temperature and installation altitude . . . . .	38	Dimensions for NBSE pumps (230 V) . . . . .	123
Liquid temperature . . . . .	38	Dimensional drawings, NBS . . . . .	125
Flow rates . . . . .	38	Flange and bare pump dimensions . . . . .	127
Pressures in the pump. . . . .	39	Dimensions for NBS pumps with TEFC motors and support rails . . . . .	129
Operating range of mechanical shaft seals . . . . .	41	Dimensions for pumps with ODP motors and support rails . . . . .	143
Recommended shaft seal for water-glycol mixture . . . . .	41	Dimension for service . . . . .	157
<b>8. Mechanical installation</b> . . . . .	<b>43</b>	<b>17. Pump Energy Index (PEI).</b> . . . . .	<b>158</b>
Installation requirements . . . . .	43	NBSE pumps with speed-controlled motors . . . . .	159
Foundation. . . . .	43	NBS pumps with fixed-speed motors . . . . .	161
Pipes and connections. . . . .	45		
Condensation cover . . . . .	46		
Expansion joints . . . . .	46		
Measuring instruments . . . . .	47		

<b>18. Motor data</b> .....	<b>162</b>
Standard motor range .....	162
MLE motor range .....	162
Electrical data, MLE motors .....	162
<b>19. Accessories</b> .....	<b>163</b>
Flow sensor .....	163
Pressure sensors .....	164
External Grundfos sensors .....	165
Potentiometer .....	166
Grundfos GO .....	166
CIU communication interface units .....	167
CIM communication interface modules .....	167
Antennas and battery .....	168
EMC filter .....	168
Shims .....	169
<b>20. Service</b> .....	<b>170</b>
<b>21. Grundfos Product Center</b> .....	<b>171</b>
<b>22. Grundfos GO</b> .....	<b>172</b>

# 1. Applications

## Introduction

NBS are multipurpose pumps suitable for a variety of different applications demanding reliable and cost-efficient supply.

The pumps are used in five main fields of application:

- water supply
- industrial pressure boosting
- industrial liquid transfer
- HVAC
- irrigation.

## Water supply

Besides general water supply in municipal and industrial waterworks, the pumps are used for these specific applications:

- filtration and transfer at waterworks
- pressure boosting in mains
- pressure boosting in high-rise buildings, hotels, etc.
- pressure boosting in industrial buildings
- various swimming bath applications
- drinking water (NSF61).

## Industrial pressure boosting

Pressure boosting in these applications:

- industrial washing and cleaning systems
- industrial wash-down systems
- vehicle washing tunnels
- firefighting systems.

## Industrial liquid transfer

Liquid transfer in these applications:

- cooling and air-conditioning systems, refrigerants
- boiler-feed and condensate systems
- aquafarming
- industrial heating systems
- district heating plants.

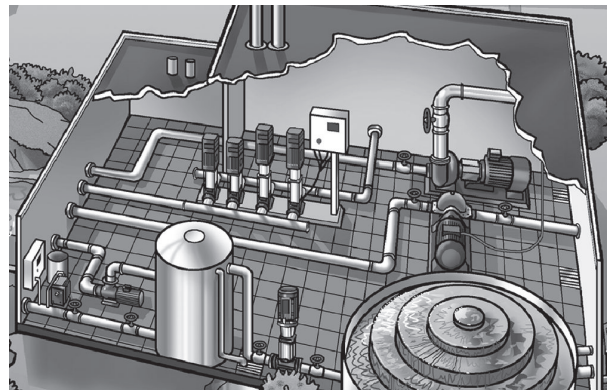

TM030146

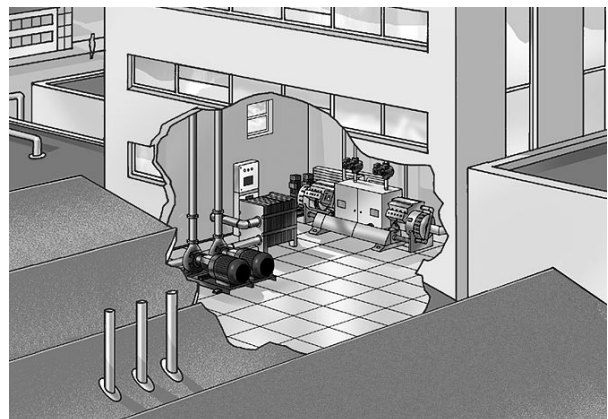

TM030147



TM030148

## HVAC

Liquid transfer in these applications:

- heating systems
- ventilation systems
- air-conditioning systems.

## Irrigation

Irrigation covers these applications:

- field irrigation, flooding
- sprinkler irrigation
- drip-feed irrigation.

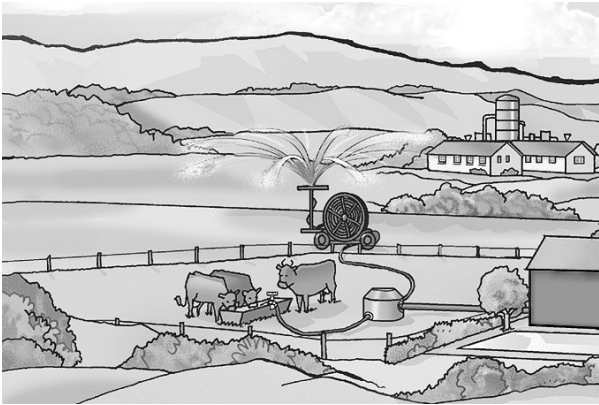

TMC030149

## 2. Features and benefits

### Features

The pumps offer the following features:

- The pumps are non-self-priming, single-stage, centrifugal volute pumps with axial inlet port, radial outlet port and horizontal shaft.
- All pumps are according to ISO 5199 standards, adjusted for American dimensions on pump and its flanges.
- Inlet and outlet flanges are according to ASME 16.1/16.42.
- Dimensions and rated performance are according to 175/363 PSI (12/25 bar). The mechanical shaft seal has dimensions according to EN 12756.
- The pumps offer flow rates from 10 to 5800 GPM and heads from 8 to 450 ft.
- Motors with main dimensions to NEMA standards.
- The pumps can be equipped with an MLE motor with integrated frequency converter or connected to a Grundfos CUE external frequency converter.

### Benefits

The pumps offer the following benefits:

- Trimmed and balanced impellers allow customization, reduce noise and vibration for quiet operation and prolong seal and bearing life. Statically balanced according to ISO 1940-1 class 6.3.
- This space-saving design has 35 % smaller footprint than frame mount design.
- Reduced installation (grouting and alignment) and wiring cost.
- Larger pumps have a double volute design which prolongs seal and bearing life, and thereby lowers life cycle costs.
- Optimized impeller design increases efficiency and reduces NPSH required.
- Integrally cast diffuser vane reduces turbulence and need for suction guides.
- If supplied with base frame, no baseplate grouting is required.
- Point-loaded spring isolation base is available.
- Radially split, rigid coupling enables rapid mechanical seal access without motor removal. Additionally, no alignment is required between the pump and motor which eliminates laser alignment costs.

- With loose flanges it is possible to turn the flange a few degrees if the counter flange has been twisted during installation and/or welding. The flange can be rotated to meet the connection.

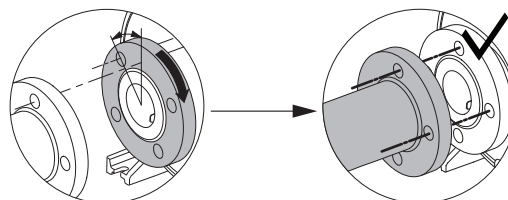

TM077935

- Overall, the design is very service friendly, reduces installation working time and the result is reduced maintenance costs.

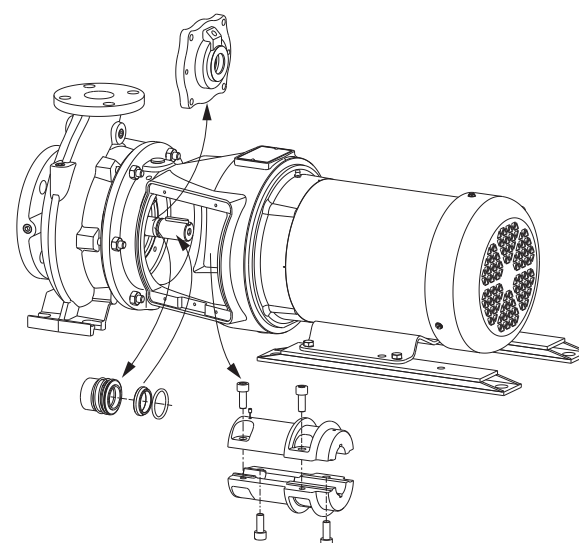

TM077934

*Pump design optimized for easy installation, easy service and low maintenance costs*

### Motor efficiency

NBS pumps are all fitted with NEMA Premium Efficiency motors.

All motors in standard range are three-phase motors.

Alternative motors can be fitted upon request.

### Pumps with electronic speed control



TM077942

NBSE pumps are NBS pumps equipped with a Grundfos MLE motor. The MLE motor is a permanent magnet motor with a built-in frequency converter and on-board controls. The on-board controls consist of advanced application software that provides the user with an all-in-one solution that is pre-programmed for electronic speed control of variable volume applications.

Electronic speed control provides continuous variable control of motor speed, enabling the automatic adaption of pump performance to a given requirement.

The Grundfos MLE utilizes a Permanent Magnet Synchronous Motor (PMSM) which carries an IE5 rating based on European Commission standards. This IE5 rating exceeds the current NEMA Premium Efficiency standard. A comparison of IE and NEMA ratings can be seen below:

IEC	NEMA
IE5	Ultra Premium <sup>1)</sup>
IE4	Super Premium/Enhanced-Premium <sup>1)</sup>
IE3	NEMA Premium

<sup>1)</sup> Common terminology. Not officially established by NEMA.

NBSE pumps with medium speed motors and low speed motors up to 30 hp (22 kW) are fitted with Grundfos permanent-magnet ML motors that have motor efficiency class IE5 according to IEC 60034-30-2.

If a sensor is installed, NBSE pumps allow for any of these configurations or control methods:

- constant pressure
- constant temperature
- constant differential pressure
- proportional differential pressure
- constant flow rate
- constant differential temperature
- constant level
- constant curve
- constant other value.

### Why select an NBSE pump?

A pump with electronic speed control offers these benefits:

- energy savings
- increased comfort
- intelligent control and monitoring of pump performance
- communication with the pump
- easy installation and setup
- integrated solution
- customization
- low maintenance cost
- remote controllable.

For further information on electronic speed control, see section Speed-controlled pumps.

### Energy-optimized pumps

NBS pumps are Energy-optimized and comply with the Department of Energy (DOE) 2020 directive, in which most pumps are classified or graduated using Pump Energy Index (PEI). See section Pump Energy Index (PEI).

### Related information

[9. Speed-controlled pumps](#)

[17. Pump Energy Index \(PEI\)](#)

### 3. Performance range

#### NBSE full range

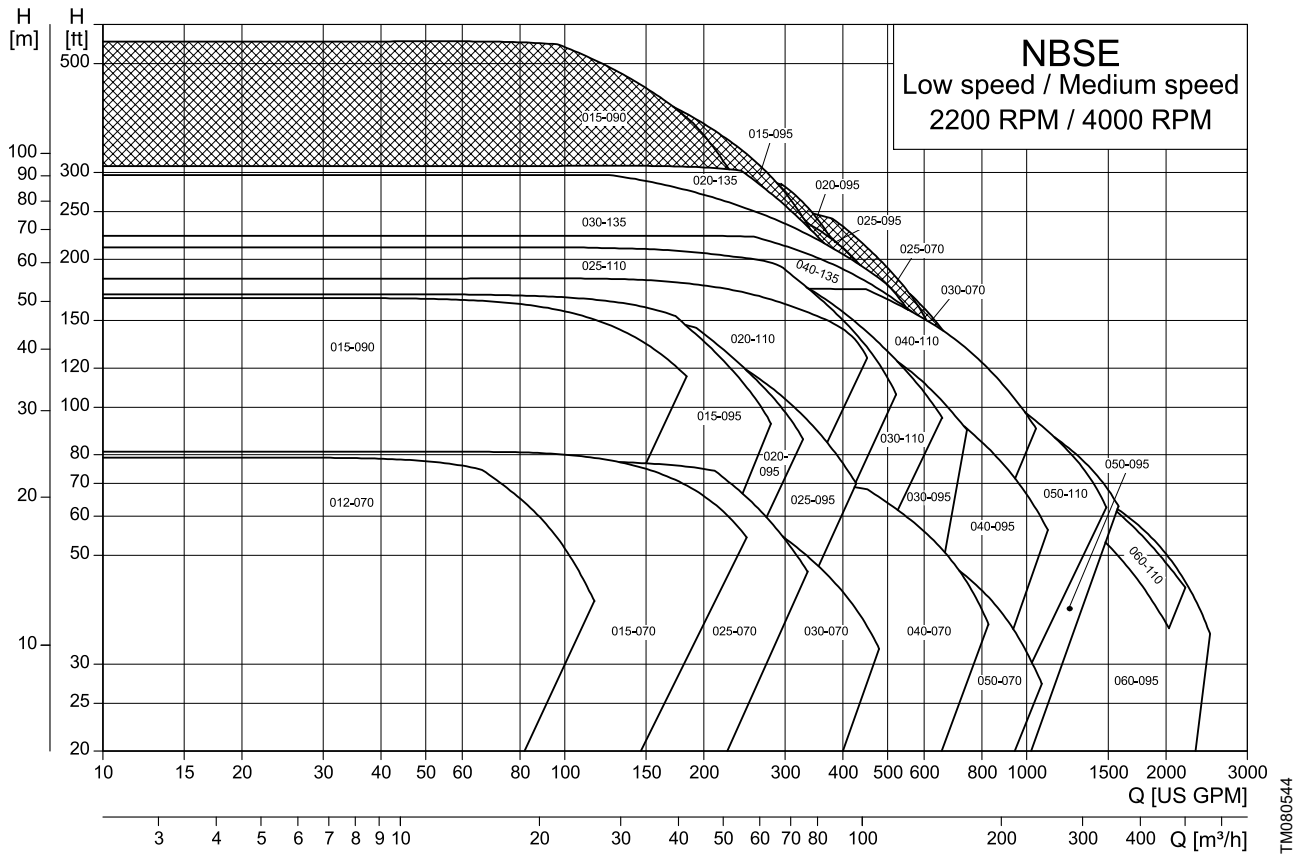

**Note:** The hatched area covers the medium speed pump range and the non-hatched area covers the low speed pump range.

TW080544



**NBSE medium speed**

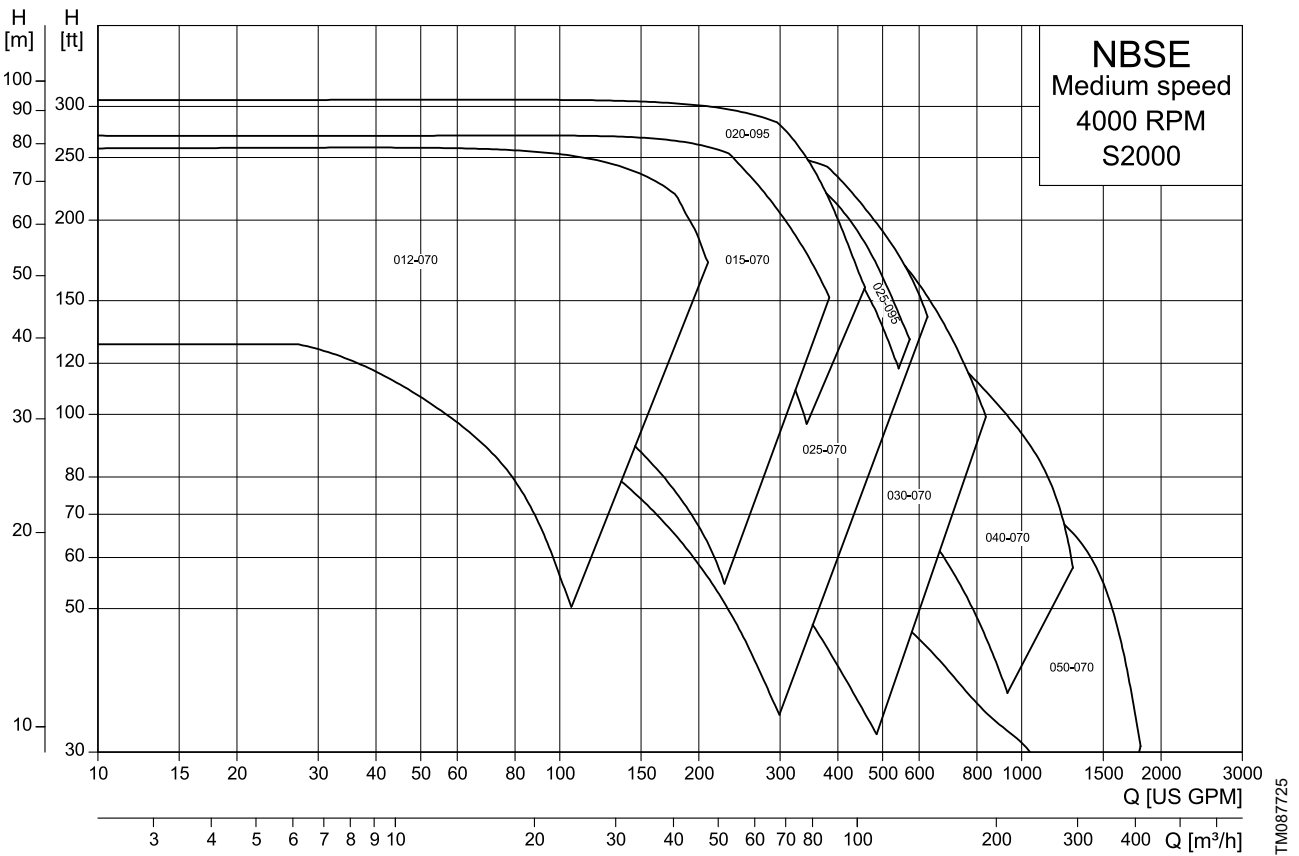
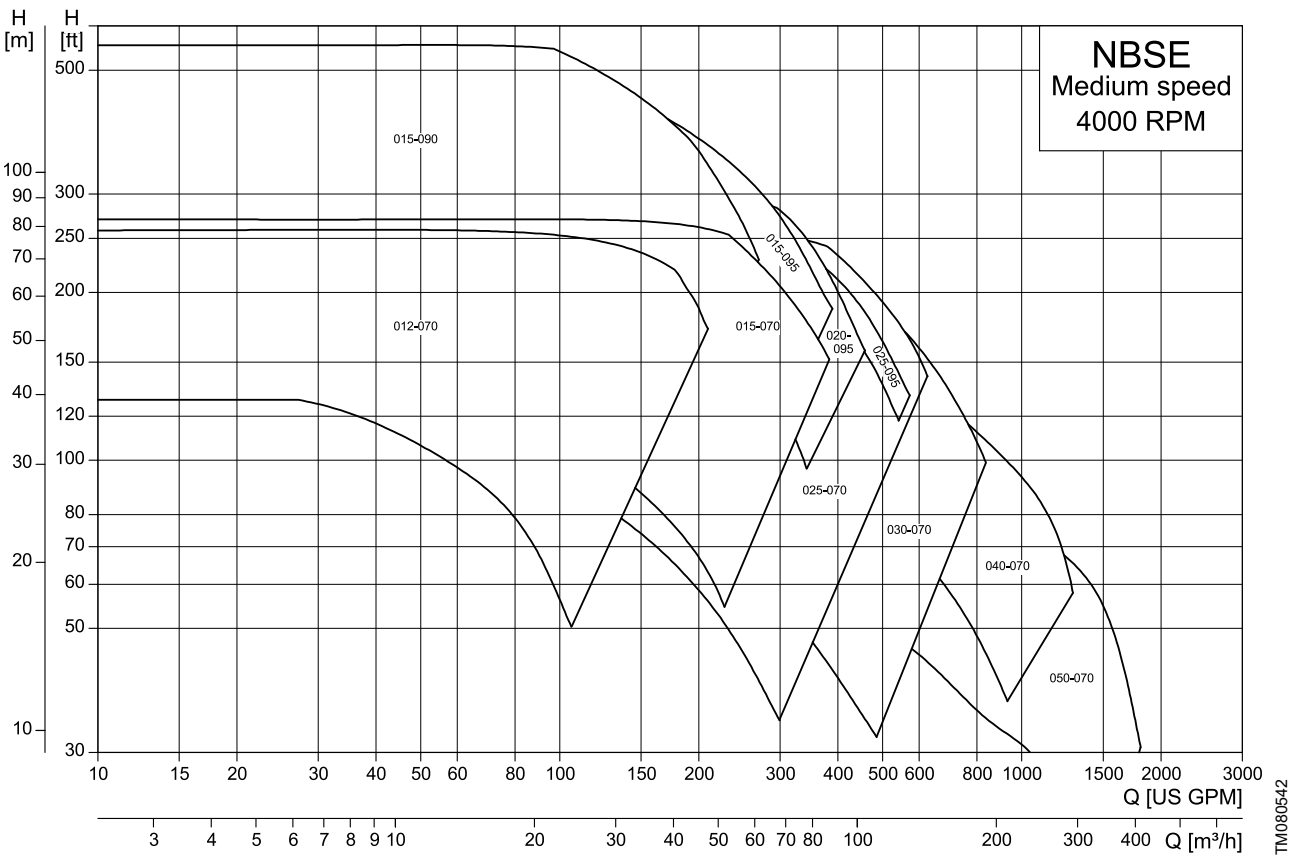

### NBSE low speed

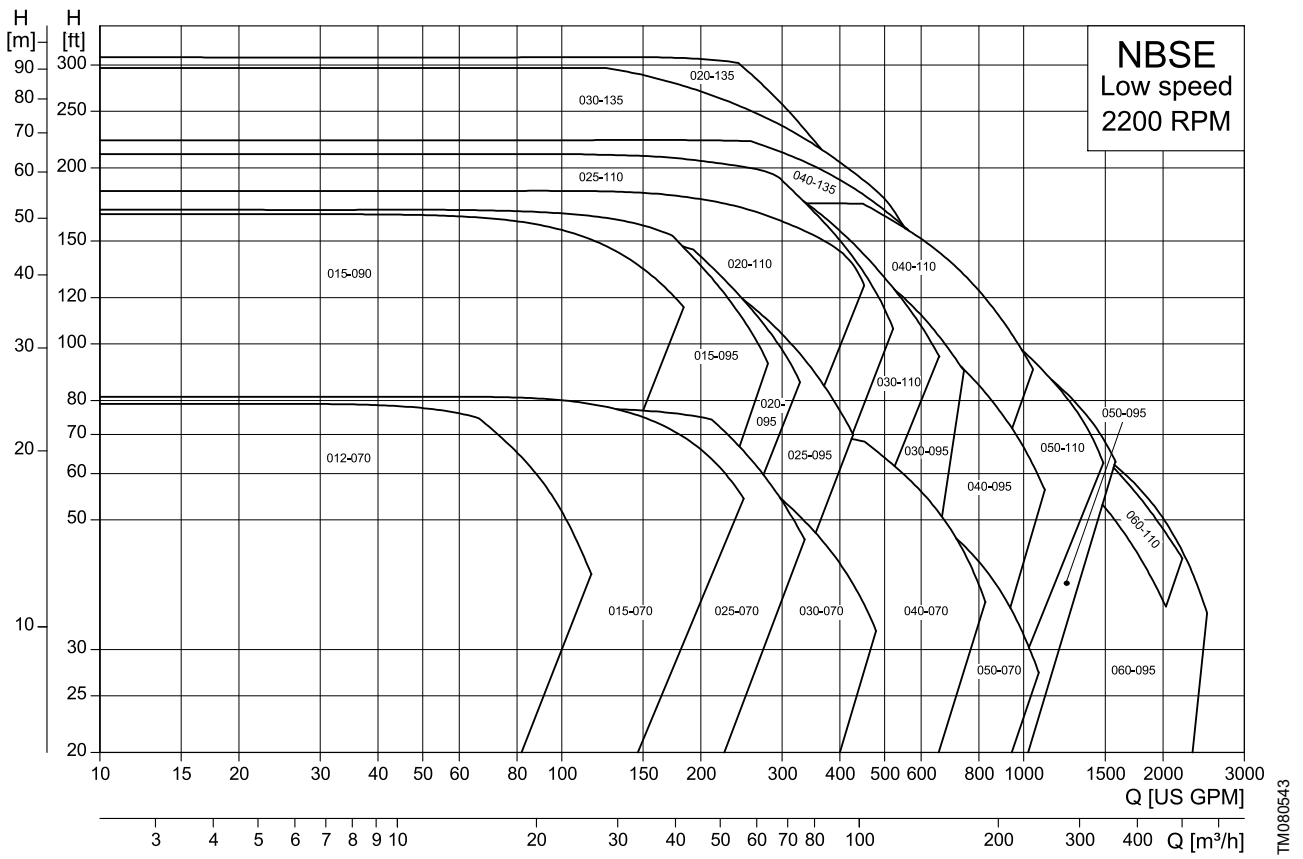

TM080543

**NBS, 2-pole**

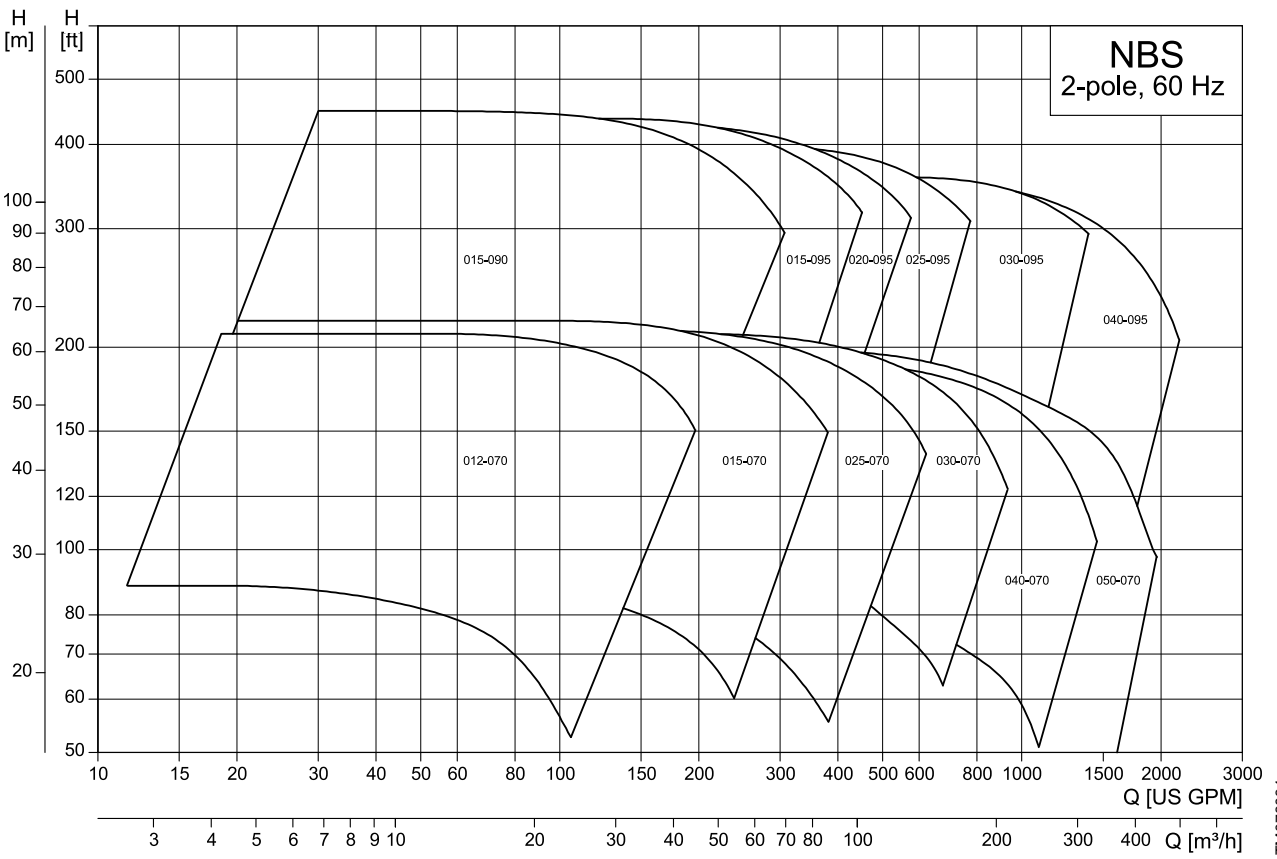

Performance range

TM078034

### NBS, 4-pole

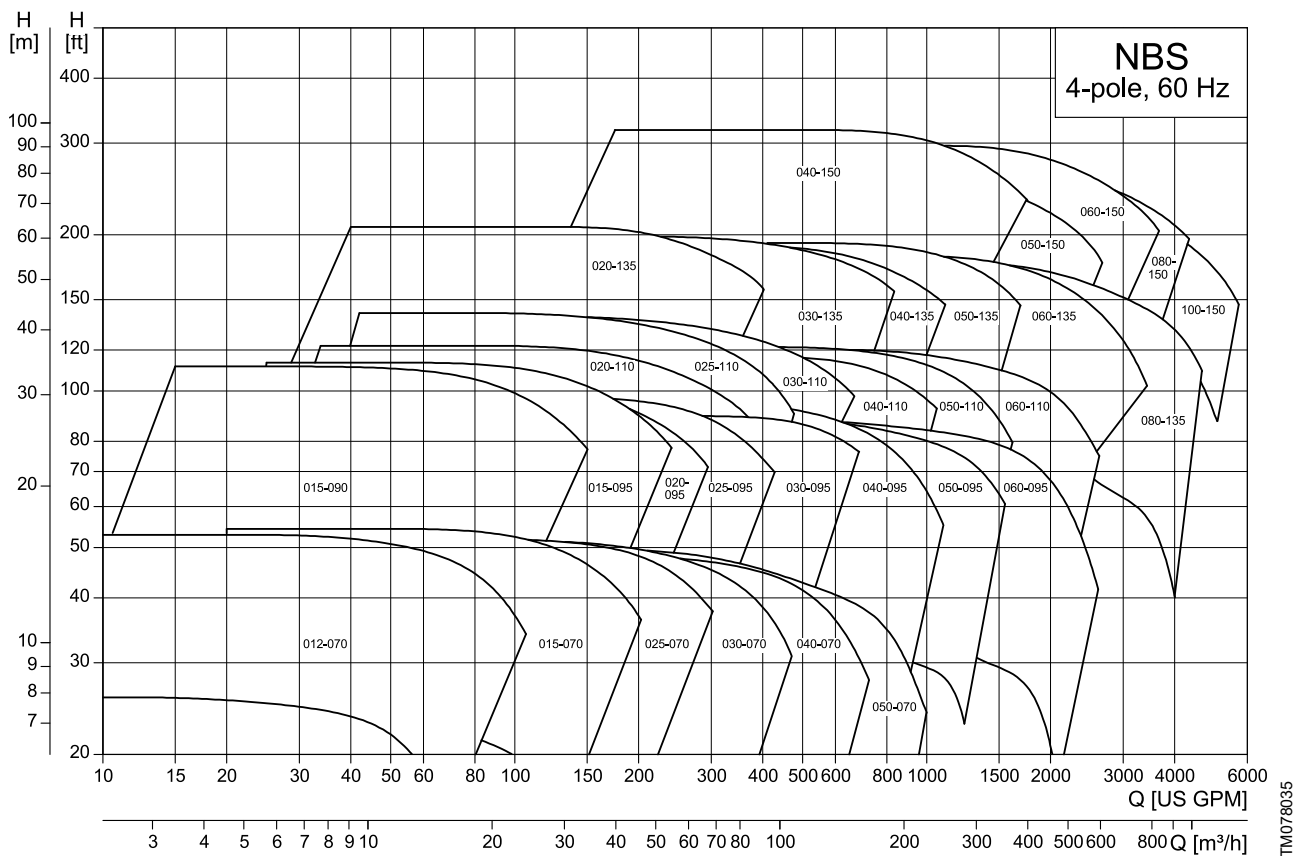

**NBS, 6-pole**

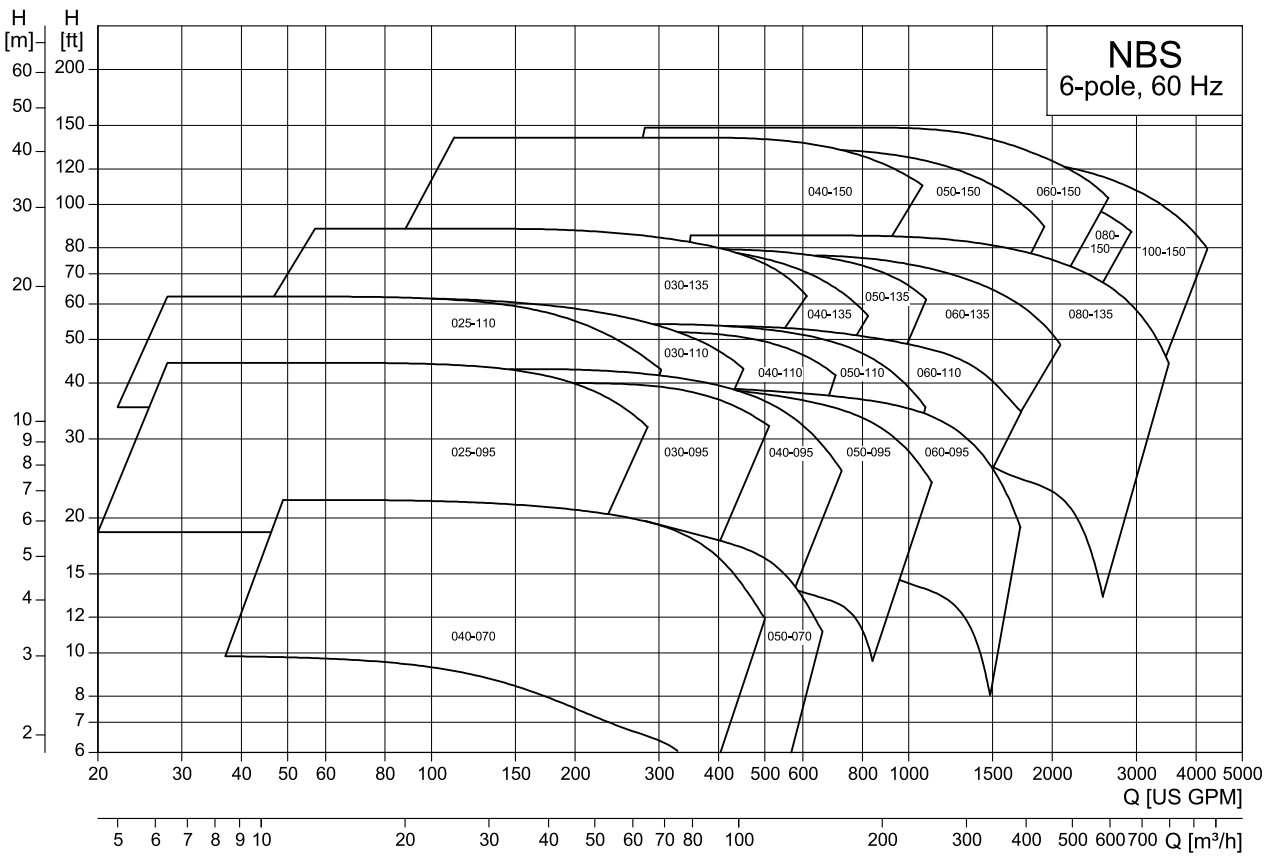

TM078036

## 4. Product range

The tables on the following pages show the complete product ranges of NBS and NBSE pumps. The standard range has been combined on the basis of the following parameters:

### Pump

- Pump housings have outlet flanges with nominal diameter from 1 1/4" to 10".
- Ductile steel versions have loose flanges. All others have fixed flanges.
- The pumps are available in mounting design B, C and F. Mounting design F has base frame and is available as an option. For further information, see section Mounting design.
- Support rails: NBS, NBSE pumps combine with many motor frame sizes and pump housings vary in size. The height difference between pump and motor are always leveled out by means of support rails under pump housing and motor, or under the motor only. Motors always have support rails to ensure easy service.

### Motor

- Motors are for 60 Hz.
- NBS pumps are available with 2-, 4- and 6-pole motors; NBSE pumps with medium speed and low speed motors.
- The pumps are available with NEMA Premium Efficiency standard (IE3) and higher. E version pumps with MLE motors has ultra-premium (IE5) efficiency.
- Motors with power rating up to and including 5 hp (4 kW) are available for "low voltage"; motors as from 3 hp (2.2 kW) are available for "high voltage".
- NBSE pumps are equipped with an MLE motor and integrated frequency converter.
- All pumps with non-E-motor can be connected to an external frequency converter.

### Related information

[Mounting design](#)

NBSE, medium speed/NBS, 2-pole

Pump size	P2 [hp]	P2 [kW]	E-solution	Flange rating <sup>2)</sup>		Standard mounting design <sup>3)</sup>	Material codes			Options											Shaft seal diameter [mm]	Standard shaft seal				
				Class 125 PN 10 (Cast iron)	Class 300 PN 25 (Ductile iron)		S2, S3, S4, S5, S6, S7, S8, S9, T2	SA, SB, SC, SD, SE, SF, SG, SH, TA	Recirculation line	NSF approvals		Coating <sup>4)</sup>			Base											
										Nylon	Copper	Stainless steel	NSF 50 (Swimming pool water)	NSF 61 (Drinking water approval)	Pump housing (volute)	Impeller	Pump housing and impeller	Without support rails	Rails with basic pad <sup>5)</sup>	Full base <sup>6)</sup>			Spring isolated base <sup>7)</sup>			
012-070	3	2.2	MLE	F	F	C	•	•	•	•	•	•	•	•	•	•	•	•	•	•	•	•	28	MG13		
	5	3.7	MLE	F	F	C	•	•	•	•	•	•	•	•	•	•	•	•	•	•	•	•	•	28	MG13	
	7.5	5.5	MLE	F	F	C	•	•	•	•	•	•	•	•	•	•	•	•	•	•	•	•	•	28	MG13	
	7.5	5.5	MLE	F	F	C	•	•	•	•	•	•	•	•	•	•	•	•	•	•	•	•	•	•	28	MG13
	10	7.5	MLE	F	F	C	•	•	•	•	•	•	•	•	•	•	•	•	•	•	•	•	•	•	28	MG13
	15	11	MLE	F	F	C	•	•	•	•	•	•	•	•	•	•	•	•	•	•	•	•	•	•	28	MG13
	15	11	MLE	F	F	C	•	•	•	•	•	•	•	•	•	•	•	•	•	•	•	•	•	•	28	MG13
015-070	5	3.7	MLE	F	L	C	•	•	•	•	•	•	•	•	•	•	•	•	•	•	•	•	•	•	28	MG13
	7.5	5.5	MLE	F	L	C	•	•	•	•	•	•	•	•	•	•	•	•	•	•	•	•	•	•	28	MG13
	10	7.5	MLE	F	L	C	•	•	•	•	•	•	•	•	•	•	•	•	•	•	•	•	•	•	28	MG13
	15	11	MLE	F	L	C	•	•	•	•	•	•	•	•	•	•	•	•	•	•	•	•	•	•	28	MG13
	20	15	MLE	F	L	C	•	•	•	•	•	•	•	•	•	•	•	•	•	•	•	•	•	•	28	MG13
015-090	15	11	MLE	F	L	B	•	•	•	•	•	•	•	•	•	•	•	•	•	•	•	•	•	•	38	MG13
	20	15	MLE	F	L	C	•	•	•	•	•	•	•	•	•	•	•	•	•	•	•	•	•	•	38	MG13
	25	18.5	MLE	F	L	C	•	•	•	•	•	•	•	•	•	•	•	•	•	•	•	•	•	•	38	MG13
	30	22	MLE	F	L	C	•	•	•	•	•	•	•	•	•	•	•	•	•	•	•	•	•	•	38	MG13
	40	30	CUE	F	L	C	•	•	•	•	•	•	•	•	•	•	•	•	•	•	•	•	•	•	38	MG13
015-095	15	11	MLE	F	L	B	•	•	•	•	•	•	•	•	•	•	•	•	•	•	•	•	•	•	38	MG13
	20	15	MLE	F	L	C	•	•	•	•	•	•	•	•	•	•	•	•	•	•	•	•	•	•	38	MG13
	25	18.5	MLE	F	L	C	•	•	•	•	•	•	•	•	•	•	•	•	•	•	•	•	•	•	38	MG13
	30	22	MLE	F	L	C	•	•	•	•	•	•	•	•	•	•	•	•	•	•	•	•	•	•	38	MG13
	40	30	CUE	F	L	C	•	•	•	•	•	•	•	•	•	•	•	•	•	•	•	•	•	•	38	MG13
	50	37	CUE	F	L	C	•	•	•	•	•	•	•	•	•	•	•	•	•	•	•	•	•	•	38	MG13
020-095	15	11	MLE	F	L	B	•	•	•	•	•	•	•	•	•	•	•	•	•	•	•	•	•	•	38	MG12
	20	15	MLE	F	L	C	•	•	•	•	•	•	•	•	•	•	•	•	•	•	•	•	•	•	38	MG12
	25	18.5	MLE	F	L	C	•	•	•	•	•	•	•	•	•	•	•	•	•	•	•	•	•	•	38	MG12
	30	22	MLE	F	L	C	•	•	•	•	•	•	•	•	•	•	•	•	•	•	•	•	•	•	38	MG12
	40	30	CUE	F	L	C	•	•	•	•	•	•	•	•	•	•	•	•	•	•	•	•	•	•	38	MG12
	50	37	CUE	F	L	C	•	•	•	•	•	•	•	•	•	•	•	•	•	•	•	•	•	•	38	MG12
	60	45	CUE	F	L	C	•	•	•	•	•	•	•	•	•	•	•	•	•	•	•	•	•	•	38	MG12
025-070	5 <sup>8)</sup>	3.7	MLE	F	L	C	•	•	•	•	•	•	•	•	•	•	•	•	•	•	•	•	•	•	28	MG13
	7.5	5.5	MLE	F	L	C	•	•	•	•	•	•	•	•	•	•	•	•	•	•	•	•	•	•	28	MG13
	10	7.5	MLE	F	L	C	•	•	•	•	•	•	•	•	•	•	•	•	•	•	•	•	•	•	28	MG13
	15	11	MLE	F	L	C	•	•	•	•	•	•	•	•	•	•	•	•	•	•	•	•	•	•	28	MG13
	20	15	MLE	F	L	C	•	•	•	•	•	•	•	•	•	•	•	•	•	•	•	•	•	•	28	MG13
	25	18.5	MLE	F	L	C	•	•	•	•	•	•	•	•	•	•	•	•	•	•	•	•	•	•	28	MG13
30	22	MLE	F	L	C	•	•	•	•	•	•	•	•	•	•	•	•	•	•	•	•	•	•	28	MG13	





8) Only for E-pump.

**Related information**

[Mounting design](#)





Pump size	P2 [hp]	P2 [kW]	E-solution	Flange rating <sup>9)</sup>		Standard mounting design <sup>10)</sup>	Material codes			Options										Shaft seal diameter [mm]	Standard shaft seal					
				Class 125 PN 10 (Cast iron)	Class 300 PN 25 (Ductile iron)		S2, S3, S4, S5, S6, S7, S8, S9, T2	SA, SB, SC, SD, SE, SF, SG, SH, TA	Recirculation line			NSF approvals		Coating <sup>11)</sup>			Base									
									Nylon	Copper	Stainless steel	NSF 50 (Swimming pool water)	NSF 61 (Drinking water approval)	Pump housing (volute)	Impeller	Pump housing and impeller	Without support rails	Rails with basic pad <sup>12)</sup>	Full base <sup>13)</sup>			Spring isolated base <sup>14)</sup>				
040-110	15	11	MLE	F	L	B	•	•	•	•	•	•	•	•	•	•	•	•	•	•	•	•	•	38	MG13	
	20	15	MLE	F	L	B	•	•	•	•	•	•	•	•	•	•	•	•	•	•	•	•	•	•	38	MG13
	25	18.5	MLE	F	L	B	•	•	•	•	•	•	•	•	•	•	•	•	•	•	•	•	•	•	38	MG13
	30	22	MLE	F	L	B	•	•	•	•	•	•	•	•	•	•	•	•	•	•	•	•	•	•	•	38
040-135	15 <sup>15)</sup>	11	MLE	F	L	B	•	•	•	•	•	•	•	•	•	•	•	•	•	•	•	•	•	•	38	MG13
	20	15	MLE	F	L	B	•	•	•	•	•	•	•	•	•	•	•	•	•	•	•	•	•	•	38	MG13
	25	18.5	MLE	F	L	B	•	•	•	•	•	•	•	•	•	•	•	•	•	•	•	•	•	•	38	MG13
	30	22	MLE	F	L	B	•	•	•	•	•	•	•	•	•	•	•	•	•	•	•	•	•	•	38	MG13
	40	30	CUE	F	L	B	•	•	•	•	•	•	•	•	•	•	•	•	•	•	•	•	•	•	38	MG13
	50	37	CUE	F	L	B	•	•	•	•	•	•	•	•	•	•	•	•	•	•	•	•	•	•	38	MG13
	50	37	CUE	F	L	B	•	•	•	•	•	•	•	•	•	•	•	•	•	•	•	•	•	•	48	MG13
040-150	60	45	CUE	F	L	B	•	•	•	•	•	•	•	•	•	•	•	•	•	•	•	•	•	•	48	MG13
	75	55	CUE	F	L	B	•	•	•	•	•	•	•	•	•	•	•	•	•	•	•	•	•	•	48	MG13
	100	75	CUE	F	L	B	•	•	•	•	•	•	•	•	•	•	•	•	•	•	•	•	•	•	48	MG13
	125	90	CUE	F	L	C	•	•	•	•	•	•	•	•	•	•	•	•	•	•	•	•	•	•	48	MG13
	150	110	CUE	F	L	C	•	•	•	•	•	•	•	•	•	•	•	•	•	•	•	•	•	•	48	MG13
	3	2.2	MLE	F	L	B	•	•	•	•	•	•	•	•	•	•	•	•	•	•	•	•	•	•	28	MG13
050-070	5	3.7	MLE	F	L	B	•	•	•	•	•	•	•	•	•	•	•	•	•	•	•	•	•	•	28	MG13
	7.5	5.5	MLE	F	L	B	•	•	•	•	•	•	•	•	•	•	•	•	•	•	•	•	•	•	28	MG13
	10	7.5	MLE	F	L	B	•	•	•	•	•	•	•	•	•	•	•	•	•	•	•	•	•	•	28	MG13
	10	7.5	MLE	F	L	B	•	•	•	•	•	•	•	•	•	•	•	•	•	•	•	•	•	•	48	MG13
050-095	15	11	MLE	F	L	B	•	•	•	•	•	•	•	•	•	•	•	•	•	•	•	•	•	•	48	MG13
	20	15	MLE	F	L	B	•	•	•	•	•	•	•	•	•	•	•	•	•	•	•	•	•	•	48	MG13
	25	18.5	MLE	F	L	B	•	•	•	•	•	•	•	•	•	•	•	•	•	•	•	•	•	•	48	MG13
	30	22	MLE	F	L	B	•	•	•	•	•	•	•	•	•	•	•	•	•	•	•	•	•	•	48	MG13
	15 <sup>15)</sup>	11	MLE	F	L	B	•	•	•	•	•	•	•	•	•	•	•	•	•	•	•	•	•	•	38	MG13
050-110	20	15	MLE	F	L	B	•	•	•	•	•	•	•	•	•	•	•	•	•	•	•	•	•	•	38	MG13
	25	18.5	MLE	F	L	B	•	•	•	•	•	•	•	•	•	•	•	•	•	•	•	•	•	•	38	MG13
	30	22	MLE	F	L	B	•	•	•	•	•	•	•	•	•	•	•	•	•	•	•	•	•	•	38	MG13
	40	30	CUE	F	L	B	•	•	•	•	•	•	•	•	•	•	•	•	•	•	•	•	•	•	38	MG13
	25	18.5	CUE	F	L	B	•	•	•	•	•	•	•	•	•	•	•	•	•	•	•	•	•	•	48	MG13
050-135	30	22	CUE	F	L	B	•	•	•	•	•	•	•	•	•	•	•	•	•	•	•	•	•	•	48	MG13
	40	30	CUE	F	L	B	•	•	•	•	•	•	•	•	•	•	•	•	•	•	•	•	•	•	48	MG13
	50	37	CUE	F	L	B	•	•	•	•	•	•	•	•	•	•	•	•	•	•	•	•	•	•	48	MG13
	60	45	CUE	F	L	B	•	•	•	•	•	•	•	•	•	•	•	•	•	•	•	•	•	•	48	MG13
	75	55	CUE	F	L	B	•	•	•	•	•	•	•	•	•	•	•	•	•	•	•	•	•	•	48	MG13
	75	55	CUE	F	L	B	•	•	•	•	•	•	•	•	•	•	•	•	•	•	•	•	•	•	48	MG13
050-150	100	75	CUE	F	L	B	•	•	•	•	•	•	•	•	•	•	•	•	•	•	•	•	•	•	48	MG13
	125	90	CUE	F	L	B	•	•	•	•	•	•	•	•	•	•	•	•	•	•	•	•	•	•	48	MG13
	150	110	CUE	F	L	B	•	•	•	•	•	•	•	•	•	•	•	•	•	•	•	•	•	•	48	MG13



## NBS, 6-pole

Pump size	P2 [hp]	P2 [kW]	E-solution	Flange rating <sup>16)</sup>		Standard mounting design <sup>17)</sup>	Material codes		Options											Shaft seal diameter [mm]	Standard shaft seal				
				Class 125 PN 10 (Cast iron)	Class 300 PN 25 (Ductile iron)		S2, S3, S4, S5, S6, S7, S8, S9, T2	SA, SB, SC, SD, SE, SF, SG, SH, TA	Recirculation line			NSF approvals		Coating <sup>18)</sup>			Base								
									Nylon	Copper	Stainless steel	NSF 50 (Swimming pool water)	NSF 61 (Drinking water approval)	Pump housing (volute)	Impeller	Pump housing and impeller	Without support rails	Rails with basic pad <sup>19)</sup>	Full base <sup>20)</sup>			Spring isolated base <sup>21)</sup>			
025-095	1	0.75	CUE	F	L	B	•	•	•	•	•	•	•	•	•	•	•	•	•	•	•	•	28	MG13	
	1.5	1.1	CUE	F	L	B	•	•	•	•	•	•	•	•	•	•	•	•	•	•	•	•	•	28	MG13
	2	1.5	CUE	F	L	B	•	•	•	•	•	•	•	•	•	•	•	•	•	•	•	•	•	28	MG13
025-110	3	2.2	CUE	F	L	B	•	•	•	•	•	•	•	•	•	•	•	•	•	•	•	•	•	28	MG13
	2	1.5	CUE	F	L	B	•	•	•	•	•	•	•	•	•	•	•	•	•	•	•	•	•	38	MG13
	3	2.2	CUE	F	L	B	•	•	•	•	•	•	•	•	•	•	•	•	•	•	•	•	•	38	MG13
030-095	5	3.7	CUE	F	L	B	•	•	•	•	•	•	•	•	•	•	•	•	•	•	•	•	•	38	MG13
	1.5	1.1	CUE	F	L	B	•	•	•	•	•	•	•	•	•	•	•	•	•	•	•	•	•	28	MG13
	2	1.5	CUE	F	L	B	•	•	•	•	•	•	•	•	•	•	•	•	•	•	•	•	•	28	MG13
030-110	3	2.2	CUE	F	L	B	•	•	•	•	•	•	•	•	•	•	•	•	•	•	•	•	•	28	MG13
	5	3.7	CUE	F	L	B	•	•	•	•	•	•	•	•	•	•	•	•	•	•	•	•	•	38	MG13
	3	2.2	CUE	F	L	B	•	•	•	•	•	•	•	•	•	•	•	•	•	•	•	•	•	38	MG13
030-135	5	3.7	CUE	F	L	B	•	•	•	•	•	•	•	•	•	•	•	•	•	•	•	•	•	38	MG13
	7.5	5.5	CUE	F	L	B	•	•	•	•	•	•	•	•	•	•	•	•	•	•	•	•	•	38	MG13
	10	7.5	CUE	F	L	B	•	•	•	•	•	•	•	•	•	•	•	•	•	•	•	•	•	38	MG13
040-070	15	11	CUE	F	L	B	•	•	•	•	•	•	•	•	•	•	•	•	•	•	•	•	•	38	MG13
	0.75	0.55	CUE	F	L	B	•	•	•	•	•	•	•	•	•	•	•	•	•	•	•	•	•	28	MG13
	1	0.75	CUE	F	L	B	•	•	•	•	•	•	•	•	•	•	•	•	•	•	•	•	•	28	MG13
040-095	1.5	1.1	CUE	F	L	B	•	•	•	•	•	•	•	•	•	•	•	•	•	•	•	•	•	28	MG13
	2	1.5	CUE	F	L	B	•	•	•	•	•	•	•	•	•	•	•	•	•	•	•	•	•	28	MG13
	2	1.5	CUE	F	L	B	•	•	•	•	•	•	•	•	•	•	•	•	•	•	•	•	•	28	MG13
040-110	3	2.2	CUE	F	L	B	•	•	•	•	•	•	•	•	•	•	•	•	•	•	•	•	•	28	MG13
	5	3.7	CUE	F	L	B	•	•	•	•	•	•	•	•	•	•	•	•	•	•	•	•	•	28	MG13
	7.5	5.5	CUE	F	L	B	•	•	•	•	•	•	•	•	•	•	•	•	•	•	•	•	•	28	MG13
040-135	3	2.2	CUE	F	L	B	•	•	•	•	•	•	•	•	•	•	•	•	•	•	•	•	•	38	MG13
	5	3.7	CUE	F	L	B	•	•	•	•	•	•	•	•	•	•	•	•	•	•	•	•	•	38	MG13
	7.5	5.5	CUE	F	L	B	•	•	•	•	•	•	•	•	•	•	•	•	•	•	•	•	•	38	MG13
040-150	10	7.5	CUE	F	L	B	•	•	•	•	•	•	•	•	•	•	•	•	•	•	•	•	•	38	MG13
	15	11	CUE	F	L	B	•	•	•	•	•	•	•	•	•	•	•	•	•	•	•	•	•	38	MG13
	15	11	CUE	F	L	B	•	•	•	•	•	•	•	•	•	•	•	•	•	•	•	•	•	48	MG13
040-150	20	15	CUE	F	L	B	•	•	•	•	•	•	•	•	•	•	•	•	•	•	•	•	•	48	MG13
	25	18.5	CUE	F	L	B	•	•	•	•	•	•	•	•	•	•	•	•	•	•	•	•	•	48	MG13
	30	22	CUE	F	L	B	•	•	•	•	•	•	•	•	•	•	•	•	•	•	•	•	•	48	MG13
040-150	40	30	CUE	F	L	B	•	•	•	•	•	•	•	•	•	•	•	•	•	•	•	•	48	MG13	

Pump size	P2 [hp]	P2 [kW]	E-solution	Flange rating <sup>16)</sup>		Standard mounting design <sup>17)</sup>	Material codes			Options										Shaft seal diameter [mm]	Standard shaft seal					
				Class 125 PN 10 (Cast iron)	Class 300 PN 25 (Ductile iron)		S2, S3, S4, S5, S6, S7, S8, S9, T2	SA, SB, SC, SD, SE, SF, SG, SH, TA	Recirculation line			NSF approvals		Coating <sup>18)</sup>			Base									
									Nylon	Copper	Stainless steel	NSF 50 (Swimming pool water)	NSF 61 (Drinking water approval)	Pump housing (volute)	Impeller	Pump housing and impeller	Without support rails	Rails with basic pad <sup>19)</sup>	Full base <sup>20)</sup>			Spring isolated base <sup>21)</sup>				
050-070	0.75	0.55	CUE	F	L	B	•	•	•	•	•	•	•	•	•	•	•	•	•	•	•	•	•	28	MG13	
	1	0.75	CUE	F	L	B	•	•	•	•	•	•	•	•	•	•	•	•	•	•	•	•	•	•	28	MG13
	1.5	1.1	CUE	F	L	B	•	•	•	•	•	•	•	•	•	•	•	•	•	•	•	•	•	•	28	MG13
	2	1.5	CUE	F	L	B	•	•	•	•	•	•	•	•	•	•	•	•	•	•	•	•	•	•	28	MG13
	3	2.2	CUE	F	L	B	•	•	•	•	•	•	•	•	•	•	•	•	•	•	•	•	•	•	28	MG13
050-095	3	2.2	CUE	F	L	B	•	•	•	•	•	•	•	•	•	•	•	•	•	•	•	•	•	•	48	MG13
	5	3.7	CUE	F	L	B	•	•	•	•	•	•	•	•	•	•	•	•	•	•	•	•	•	•	48	MG13
	7.5	5.5	CUE	F	L	B	•	•	•	•	•	•	•	•	•	•	•	•	•	•	•	•	•	•	48	MG13
	10	7.5	CUE	F	L	B	•	•	•	•	•	•	•	•	•	•	•	•	•	•	•	•	•	•	48	MG13
050-110	5	3.7	CUE	F	L	B	•	•	•	•	•	•	•	•	•	•	•	•	•	•	•	•	•	•	38	MG13
	7.5	5.5	CUE	F	L	B	•	•	•	•	•	•	•	•	•	•	•	•	•	•	•	•	•	•	38	MG13
	10	7.5	CUE	F	L	B	•	•	•	•	•	•	•	•	•	•	•	•	•	•	•	•	•	•	38	MG13
	15	11	CUE	F	L	B	•	•	•	•	•	•	•	•	•	•	•	•	•	•	•	•	•	•	38	MG13
050-135	10	7.5	CUE	F	L	B	•	•	•	•	•	•	•	•	•	•	•	•	•	•	•	•	•	•	48	MG13
	15	11	CUE	F	L	B	•	•	•	•	•	•	•	•	•	•	•	•	•	•	•	•	•	•	48	MG13
	20	15	CUE	F	L	B	•	•	•	•	•	•	•	•	•	•	•	•	•	•	•	•	•	•	48	MG13
050-150	25	18.5	CUE	F	L	B	•	•	•	•	•	•	•	•	•	•	•	•	•	•	•	•	•	•	48	MG13
	30	22	CUE	F	L	B	•	•	•	•	•	•	•	•	•	•	•	•	•	•	•	•	•	•	48	MG13
	40	30	CUE	F	L	B	•	•	•	•	•	•	•	•	•	•	•	•	•	•	•	•	•	•	48	MG13
	50	37	CUE	F	L	B	•	•	•	•	•	•	•	•	•	•	•	•	•	•	•	•	•	•	48	MG13
	60	45	CUE	F	L	B	•	•	•	•	•	•	•	•	•	•	•	•	•	•	•	•	•	•	48	MG13
060-095	5	3.7	CUE	F	L	B	•	•	•	•	•	•	•	•	•	•	•	•	•	•	•	•	•	•	48	MG13
	7.5	5.5	CUE	F	L	B	•	•	•	•	•	•	•	•	•	•	•	•	•	•	•	•	•	•	48	MG13
	10	7.5	CUE	F	L	B	•	•	•	•	•	•	•	•	•	•	•	•	•	•	•	•	•	•	48	MG13
	15	11	CUE	F	L	B	•	•	•	•	•	•	•	•	•	•	•	•	•	•	•	•	•	•	48	MG13
060-110	7.5	5.5	CUE	F	L	B	•	•	•	•	•	•	•	•	•	•	•	•	•	•	•	•	•	•	48	MG13
	10	7.5	CUE	F	L	B	•	•	•	•	•	•	•	•	•	•	•	•	•	•	•	•	•	•	48	MG13
	15	11	CUE	F	L	B	•	•	•	•	•	•	•	•	•	•	•	•	•	•	•	•	•	•	48	MG13
	20	15	CUE	F	L	B	•	•	•	•	•	•	•	•	•	•	•	•	•	•	•	•	•	•	48	MG13
	10	7.5	CUE	F	L	B	•	•	•	•	•	•	•	•	•	•	•	•	•	•	•	•	•	•	48	MG13
060-135	15	11	CUE	F	L	B	•	•	•	•	•	•	•	•	•	•	•	•	•	•	•	•	•	•	48	MG13
	20	15	CUE	F	L	B	•	•	•	•	•	•	•	•	•	•	•	•	•	•	•	•	•	•	48	MG13
	25	18.5	CUE	F	L	B	•	•	•	•	•	•	•	•	•	•	•	•	•	•	•	•	•	•	48	MG13
	30	22	CUE	F	L	B	•	•	•	•	•	•	•	•	•	•	•	•	•	•	•	•	•	•	48	MG13
060-150	40	30	CUE	F	L	B	•	•	•	•	•	•	•	•	•	•	•	•	•	•	•	•	•	•	55	MG13
	50	37	CUE	F	L	B	•	•	•	•	•	•	•	•	•	•	•	•	•	•	•	•	•	•	55	MG13
	60	45	CUE	F	L	B	•	•	•	•	•	•	•	•	•	•	•	•	•	•	•	•	•	•	55	MG13
	75	55	CUE	F	L	B	•	•	•	•	•	•	•	•	•	•	•	•	•	•	•	•	•	•	55	MG13
	100	75	CUE	F	L	B	•	•	•	•	•	•	•	•	•	•	•	•	•	•	•	•	•	•	55	MG13

Pump size	P2 [hp]	P2 [kW]	E-solution	Flange rating <sup>16)</sup>		Standard mounting design <sup>17)</sup>	Material codes			Options										Shaft seal diameter [mm]	Standard shaft seal						
				Class 125 PN 10 (Cast iron)	Class 300 PN 25 (Ductile iron)		S2, S3, S4, S5, S6, S7, S8, S9, T2	SA, SB, SC, SD, SE, SF, SG, SH, TA	Recirculation line			NSF approvals		Coating <sup>18)</sup>			Base										
									Nylon	Copper	Stainless steel	NSF 50 (Swimming pool water)	NSF 61 (Drinking water approval)	Pump housing (volute)	Impeller	Pump housing and impeller	Without support rails	Rails with basic pad <sup>19)</sup>	Full base <sup>20)</sup>			Spring isolated base <sup>21)</sup>					
080-135	15	11	CUE	F	L	B	•	•	•	•	•	•	•	•	•	•	•	•	•	•	•	•	•	48	MG13		
	20	15	CUE	F	L	B	•	•	•	•	•	•	•	•	•	•	•	•	•	•	•	•	•	•	48	MG13	
	25	18.5	CUE	F	L	B	•	•	•	•	•	•	•	•	•	•	•	•	•	•	•	•	•	•	48	MG13	
	30	22	CUE	F	L	B	•	•	•	•	•	•	•	•	•	•	•	•	•	•	•	•	•	•	•	48	MG13
	40	30	CUE	F	L	B	•	•	•	•	•	•	•	•	•	•	•	•	•	•	•	•	•	•	•	48	MG13
080-150	50	37	CUE	F	L	B	•	•	•	•	•	•	•	•	•	•	•	•	•	•	•	•	•	•	•	48	MG13
	40	30	CUE	F	L	B	•	•	•	•	•	•	•	•	•	•	•	•	•	•	•	•	•	•	•	55	MG13
	50	37	CUE	F	L	B	•	•	•	•	•	•	•	•	•	•	•	•	•	•	•	•	•	•	•	55	MG13
	60	45	CUE	F	L	B	•	•	•	•	•	•	•	•	•	•	•	•	•	•	•	•	•	•	•	55	MG13
100-150	75	55	CUE	F	L	B	•	•	•	•	•	•	•	•	•	•	•	•	•	•	•	•	•	•	•	55	MG13
	50	37	CUE	F	L	B	•	•	•	•	•	•	•	•	•	•	•	•	•	•	•	•	•	•	•	55	MG13
	60	45	CUE	F	L	B	•	•	•	•	•	•	•	•	•	•	•	•	•	•	•	•	•	•	•	55	MG13
	75	55	CUE	F	L	B	•	•	•	•	•	•	•	•	•	•	•	•	•	•	•	•	•	•	•	55	MG13
	100	75	CUE	F	L	B	•	•	•	•	•	•	•	•	•	•	•	•	•	•	•	•	•	•	•	55	MG13

<sup>16)</sup> F: fixed flange; L: loose flange.

<sup>17)</sup> For information about mounting designs, see section Mounting design.

<sup>18)</sup> Scotchkote coating to improve corrosion and wear resistance.

<sup>19)</sup> Rails with house-keeping pads. Pad counteracts slightly uneven and rough foundation, provides some vibration and sound isolation.

<sup>20)</sup> Full base frame. An extended drip pad is available.

<sup>21)</sup> Point-loaded spring isolation base. Springs are available on request.

## Related information

[Mounting design](#)

## E-pumps

P2, MLE motor [hp]	NBSE						NBSE Series 2000						
	Medium speed, 4000 RPM		Low speed, 2000 RPM		Low speed, 2200 RPM		Medium speed, 4000 RPM		Low speed, 2000 RPM		Low speed, 2200 RPM		
	460 V	200-240 V	460 V	200-240 V	460 V	200-240 V	460 V	200-240 V	460 V	200-240 V	460 V	200-240 V	
1.5	-	-	•	-	-	-	-	-	-	•	-	-	-
2	-	-	•	-	-	-	-	-	-	•	-	-	-
3	•	•	-	-	•	-	•	•	-	-	-	•	-
5	•	•	-	-	•	-	•	•	-	-	-	•	-
7.5	•	•	-	-	•	-	•	•	-	-	-	•	-
10	•	•	-	-	•	-	•	•	-	-	-	•	-
15	•	•	-	-	•	-	•	•	-	-	-	•	-
20	•	-	-	-	•	-	•	-	-	-	-	•	-
25	•	-	-	-	•	-	•	-	-	-	-	•	-
30	•	-	-	-	•	-	•	-	-	-	-	•	-



# 5. Identification

## Nameplate

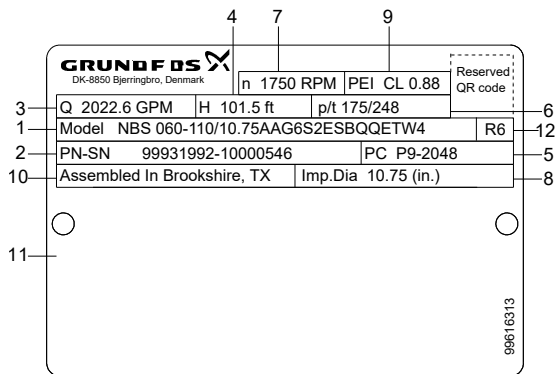

TM075296

Example of NBS nameplate

Pos.	Description
1	Type designation
2	Product number and production serial number
3	Flow
4	Head
5	Production code
6	Pressure and temperature
7	Pump speed
8	Impeller diameter
9	PEI CL: Pump Energy Index, constant load PEI VL: Pump Energy Index, variable load
10	Place of production
11	Field for approval marks and associated texts
12	Range identification (service range code)

## Type key

Example 1: NBS 025-095/08.43AAEG6S3ESBQQETX2

Example 2: NBS 040-150/16.77AFEG7TBESDQQE1X4

Example 3: NBS 060-135/1291-1276AAEG7TBESDQQEWX4

Example 4: NBSE 025-110/11.02ASFEG6S2ESBQQENDA

Example 5: NBSE 030-110/1094-1063ACAEG7S7FSDAQFODA

Pos.	1	2	3	4	5	6	7	8	9	10	11	12	13	14	15	16	17
Example 1	NBS	025	-095	/08.43		A		AE	G	6	S3	E	S	BQQE	T	X	2
Example 2	NBS	040	-150	/16.77		A		FE	G	7	TB	E	S	DQQE	1	X	4
Example 3	NBS	060	-135	/1291-1276		A		AE	G	7	TB	E	S	DQQE	W	X	4
Example 4	NBSE	025	-110	/11.02		A	S	FE	G	6	S2	E	S	BQQE	N	D	A
Example 5	NBSE	030	-110	/1094-1063		A	C	AE	G	7	S7	F	S	DAQF	O	D	A

Pos.	Explanation
1	Type range
2	Nominal diameter of outlet port (DN)
3	Nominal impeller diameter [inch]
4	Actual impeller diameter [inch]
	<b>Impeller type</b>
	'blank': Closed impeller, cylindrical trim. If one dimension is shown the impeller has a cylindrical trim, for example 11.02
5	'blank': Closed impeller, conical trim. If two dimensions are shown the impeller has a conical trim, for example 1094-1063 S: Special open impeller V: Super vortex impeller
	<b>Hydraulic version</b>
	A: 1st version
6	B: 2nd version C: 3rd version D: 4th version
	<b>Sensor/motor version</b>
	'blank': Pump without sensor
7	C: Without built-in sensor, one cable and one pressure sensor are supplied with the pump S: Pump with built-in differential-pressure sensor, Series 2000 G: Non -E pump/ -E pump with semi-integrated VFD/CUE: Motor with Grounding ring: Non drive-end
	<b>Code for pump version; the codes may be combined</b>
	A: Basic version
	B: Oversize motor
8	C: Without motor (+E): With ATEX approval, certificate or test report, the second character of the code for pump version is an E F: Design with base frame (+S): With support rails, the second character of the pump version code is an S X: Special version; used in case of further customization than already listed
	<b>Pipe connection</b>
9	G: ANSI flange
	<b>Flange pressure rating (PN - rated pressure)</b>
10	5: Other pressure rating 6: Class 125, 175 PSI 7: Class 300, 363 PSI

Pos.	Explanation			
	<b>Code for materials</b>			
	<b>Code</b>	<b>Pump housing</b>	<b>Impeller</b>	<b>Wear ring</b>
				<b>Shaft</b>
	S2	A48 Class 35	304	No wear ring
	S3	A48 Class 35	304	No wear ring
	S4	A48 Class 35	304	No wear ring
	S5	A48 Class 35	304	No wear ring
	S6	A48 Class 35	316	No wear ring
	S7	A48 Class 35	316	No wear ring
	S8	A48 Class 35	316	No wear ring
	S9	A48 Class 35	316	No wear ring
11	SA	70-50-05	304	No wear ring
	SB	70-50-05	304	No wear ring
	SC	70-50-05	304	No wear ring
	SD	70-50-05	304	No wear ring
	SE	70-50-05	316	No wear ring
	SF	70-50-05	316	No wear ring
	SG	70-50-05	316	No wear ring
	SH	70-50-05	316	No wear ring
	T2	A48 Class 35	CD4MCuN/A890	No wear ring
	TA	70-50-05	CD4MCuN/A890	No wear ring
	X	Special version		
	<b>Rubber parts in pump</b>			
	E: EPDM			
	F: FXM (Fluoraz®)			
12	K: FFKM (Kalrez®)			
	M: FEPS (PTFE-sheathed silicone O-ring)			
	O: HNBR			
	V: FKM (Viton®)			
	<b>Shaft seal arrangement</b>			
13	S: Single seal			
	<b>Shaft seal in pump</b>			
14	Letter code for mechanical shaft seal and shaft seal rubber parts. See Letter codes for shaft seals.			
15	Code for rated motor power [kW]. See Codes for rated motor power.			
16	Code for DOE identification. See Code for DOE identification.			
17	Code for speed variant [rpm]. See Codes for speed variant.			

### Letter codes for shaft seals

Pos. 14 in NBS type key example.

Code example	Description	Code explanation
B	Shaft seal type	A: O-ring seal with fixed driver B: Rubber bellows seal D: O-ring seal, balanced
Q	Material of rotating seal face	A: Carbon, metal-impregnated with antimony which is not approved for potable water B: Carbon, resin-impregnated Q: Silicon carbide
Q	Material of stationary seal	A: Carbon, metal-impregnated with antimony which is not approved for potable water Q: Silicon carbide
E	Material of secondary seal and other rubber and composite parts, except the wear ring	E: EPDM V: FKM (Viton®) F: FXM (Fluoraz®) K: FFKM (Kalrez®) X: HNBR U: Dynamic O-rings in FFKM and static O-rings in PTFE

## Codes for rated motor power

Pos. 15 in NBS type key example.

Code	Description	
	[hp]	[kW]
A	0.16	0.12
B	0.25	0.18
C	0.33	0.25
D	0.5	0.37
E	0.75	0.55
F	1	0.75
G	1.5	1.1
H	2	1.5
I	3	2.2
J	4	3
K	5 (5.5 <sup>22)</sup> )	3.7 (4 <sup>22)</sup> )
L	7.5	5.5
M	10	7.5
N	15	11
O	20	15
P	25	18.5
Q	30	22
R	40	30
S	50	37
T	60	45
U	75	55
V	100	75
W	125	90
X	Bare shaft pump	
Y	> 200 <sup>23)</sup>	> 150 <sup>23)</sup>
1	150	110
2	175	132
3	200	150
4	215 <sup>24)</sup>	160 <sup>24)</sup>
5	250 <sup>24)</sup>	185 <sup>24)</sup>
6	-	26

<sup>22)</sup> Value in bracket is for the standard IEC motor size. Value outside bracket is for the motor size according to NEMA standards.

<sup>23)</sup> Used for pumps where the pump shaft input power exceeds 200 hp (150 kW) and is not regulated under the DOE pump rule.

<sup>24)</sup> Special cases with power sizes above 200 hp (150 kW) which are still regulated under the DOE pump rule. For example: Pump has a P2 value of 198 hp (147.6 kW) in its duty point (in DOE scope) but customer wants the 215 hp (160 kW) motor instead of the 200 hp (150 kW). The pump is in scope of the DOE regulation and requires a PEI value and a motor code.

## Code for DOE identification

Pos. 16 in NBS type key example.

Code	Description
A	DOE reported with E-motor (ECM <sup>25)</sup> ), 1 x 200-240 V
B	DOE reported with E-motor (ECM <sup>25)</sup> ), 3 x 200-240 V
C	DOE reported with E-motor (ECM <sup>25)</sup> ), 3 x 440-480 V
D	DOE reported with E-motor (ECM <sup>25)</sup> ), 3 x 380-500 V
W	In DOE scope but not compliant with or not for sale in North America
X	DOE reported, sell as bare shaft pump or DOE regulated Motor (CC marked motor)
Y	Pumps not subject to the DOE regulation
Z	DOE reported with Asynchronous E-Motor

<sup>25)</sup> ECM: Electronically Commutated Motor.

## Codes for speed variant

Pos. 17 in NBS type key example.

Code	Description
A	1450-2200 RPM, E-motor (ECM <sup>26)</sup> )
B	2900-4000 RPM, E-motor (ECM <sup>26)</sup> )
C	4000-5900 RPM, E-motor (ECM <sup>26)</sup> )
1	2-pole, 50 Hz (Asynchronous motor)
2	2-pole, 60 Hz (Asynchronous motor)
3	4-pole, 50 Hz (Asynchronous motor)
4	4-pole, 60 Hz (Asynchronous motor)
5	6-pole, 50 Hz (Asynchronous motor)
6	6-pole, 60 Hz (Asynchronous motor)
7	8-pole, 50 Hz (Asynchronous motor)
8	8-pole, 60 Hz (Asynchronous motor)

<sup>26)</sup> ECM: Electronically Commutated Motor.

## 6. Construction

### NBS, center-line outlet

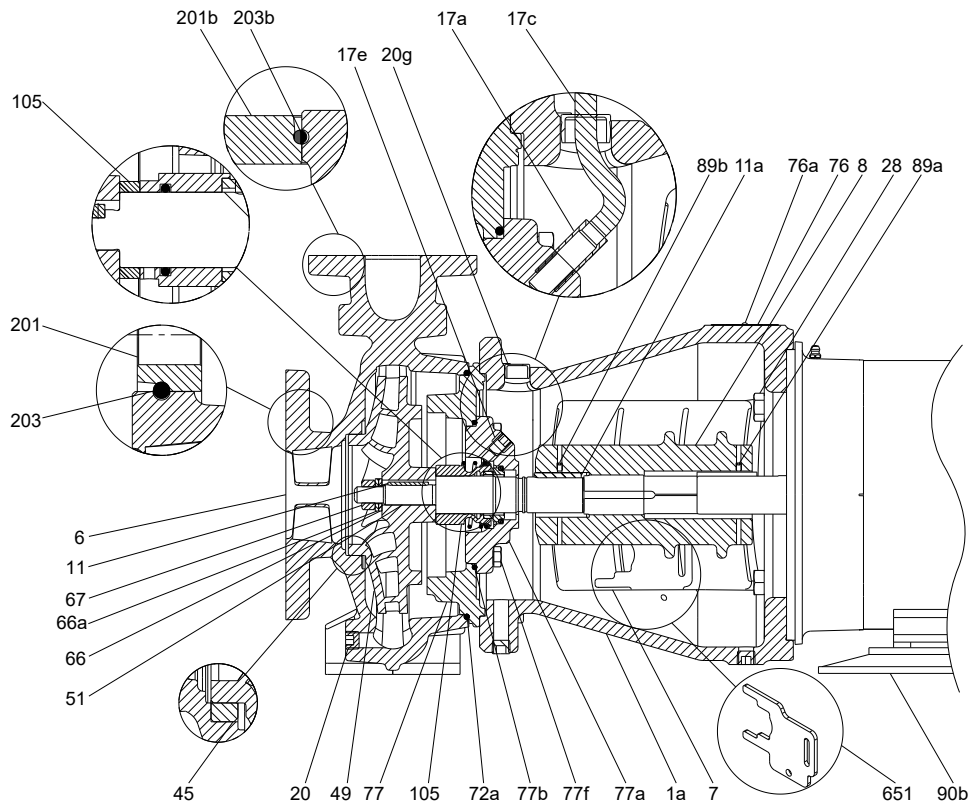

TM077165

### NBS, tangential outlet

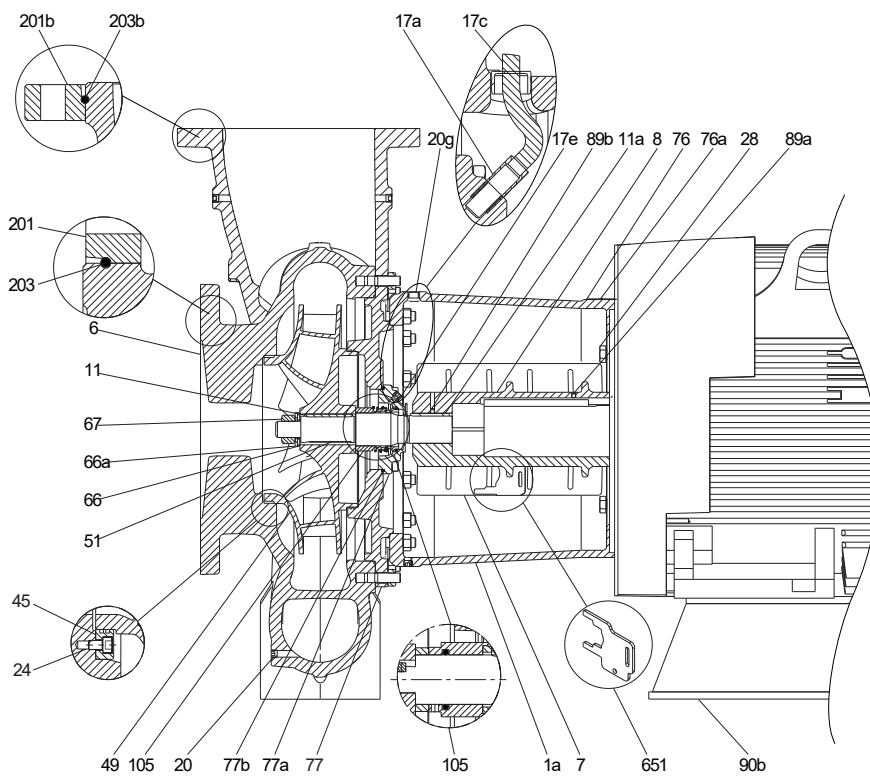

TM077285

## Material specification, NBS

Pos.	Description	Materials	
		AISI/ASTM	EN/ISO
1a	Motor stool	ASTM Class 35 (Gray cast iron)	EN-GJL-250
6	Pump housing	ASTM Class 35 (Gray cast iron)	EN-GJL-250
		ASTM 70-50-05 (Ductile cast iron)	EN-GJS-500-7
7	Coupling guard	AISI 430	EN 1.4016
7a	Screw (coupling guard)	ASTM F568 grade 12.9	DN 912 grade 12.9
8	Coupling complete, split design	ASTM 70-50-05 (Ductile cast iron)	EN-GJS-500-7
9	Screw (coupling)	ASTM F568 grade 12.9	DN 912 grade 12.9
11	Key	AISI 316	EN 1.4401
		SAF 2205	EN 1.4462
11a	Key	Steel	Steel
		UNS C38500	2.0401 (CuZn39Pb3)
17	Air vent plug (optional)	AISI 316	EN 1.4401
		AISI 904L	EN 1.4539
17a	Pipe connector	Brass	Brass
17c	Pipe, re-circulation line	Nylon	Nylon
		Copper	Copper
		Stainless steel	Stainless steel
17e	Plug (Hexagon socket head plug)	ASTM F568 grade 8.8 (A327)	ISO 898 class 8.8
		AISI 316	EN 1.4401
		AISI 904L	EN 1.4539
20b	Plug	ASTM F568 grade 8.8 (A327)	ISO 898 class 8.8
		AISI 316	EN 1.4401
		AISI 904L	EN 1.4539
20e	Plug	ASTM F568 grade 8.8 (A327)	ISO 898 class 8.8
		AISI 316	EN 1.4401
		AISI 904L	EN 1.4539
20g	2-part plug	Composite	Composite
24	Hexagon socket head cap screw	AISI 316	EN 1.4401
		AISI 904L	EN 1.4539
26	Staybolt	ASTM Grade 8.8	DIN 939 class 8.8
26a	Staybolt	ASTM Grade 8.8	DIN 939 class 8.8
28	Screw	AISI 304	EN 1.4301
36	Nut	ASTM A193	DIN 934/ISO 4032 Grade 8
36b	Nut	ASTM A193	DIN 934/ISO 4032 Grade 8
45	Wear ring (optional)	UNS C 90700	EN CuSn10-C-GS
		ASTM Class 35 (Gray cast iron)	EN-GJL-250
		UNS C 86700	EN CuZn34Mn3AL2Fe1-C
49	Impeller	ASTM A351 CF8	EN 1.4308
		AISI 316	EN 1.4408
	Impeller (optional)	ASTM CD4MCuN	EN 1.4517
51	Shaft	AISI 420	EN 1.4021/1.4034
		AISI 304	EN 1.4301
		AISI 316	EN 1.4401
	Shaft (optional)	SAF 2205	EN 1.4462
66	Washer	AISI 304	EN 1.4301
		AISI 316	EN 1.4401
66a	Spring lock washer	AISI 904L	EN 1.4539
		AISI 304	EN 1.4301
		AISI 316	EN 1.4401
		AISI 904L	EN 1.4539

Pos.	Description	Materials	
		AISI/ASTM	EN/ISO
67	Impeller nut	AISI 304	EN 1.4301
		AISI 316	EN 1.4401
		AISI 904L	EN 1.4539
72a	O-ring	EPDM	EPDM
		Viton	Viton
		EPDM-NSF	EPDM-NSF
76	Nameplate	Aluminum	Aluminum
76a	Rivet	Aluminum	Aluminum
77	Cover	ASTM 70-50-05 (Ductile cast iron)	EN-GJS-500-7
77a	Seal cover	ASTM 70-50-05 (Ductile cast iron)	EN-GJS-500-7
77b	O-ring	EPDM	EPDM
		Viton	Viton
		EPDM-NSF	EPDM-NSF
77f	Screw	ASTM F568 grade 12.9	DN 912 grade 12.9
89a	Set screw	Carbon Steel	Carbon Steel
89b	Set screw	Carbon Steel	Carbon Steel
90a	Screw	Carbon Steel	Carbon Steel
90b	Support rail	ASTM A36	EN S275
90f	Support rail	ASTM A36	EN S275
90g	Screw	Carbon Steel	Carbon Steel
90h	Washer	Carbon Steel	Carbon Steel
90i	Washer	Carbon Steel	Carbon Steel
105	Shaft seal	AISI 316	EN 1.4401
		Hastelloy C-4	EN 2.4610
105c	Spacer, shaft seal	AISI 316	EN 1.4401
		SAF 2205	EN 1.4462
201	Loose flange inlet	ASTM 70-50-05 (Ductile cast iron)	EN-GJS-500-7
		AISI 316	EN 1.4401
201a	Loose flange outlet	ASTM 70-50-05 (Ductile cast iron)	EN-GJS-500-7
		AISI 316	EN 1.4401
203	Retainer, inlet	ASTM 301	EN 1.4310
203a	Retainer, outlet	ASTM 301	En 1.4310
651	Fork tool	AISI 304	EN 1.4301
651a	Screw, fork tool	ASTM 304	A2 stainless steel

## Mechanical construction

### Mounting design

NBS pumps come in these mounting designs:

#### Mounting design B: support rail under motor

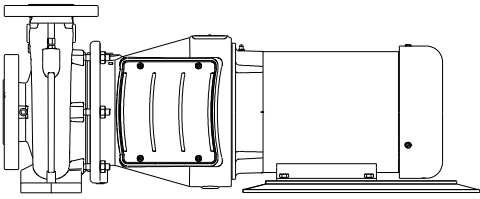

Mounting design B

#### Mounting design C: support rails under pump housing and under motor

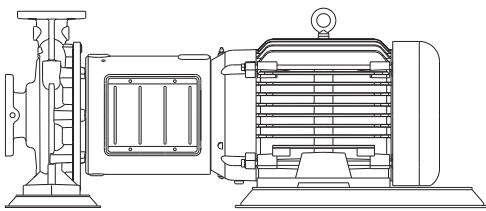

Mounting design C

#### Mounting design F: support rail under motor with base frame

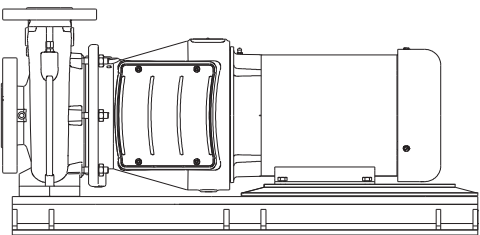

Mounting design F

#### Mounting design F: support rails under pump housing and under motor with base frame

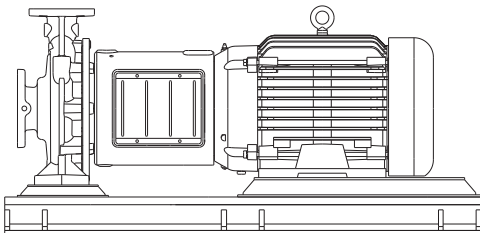

Mounting design F

### Pump housing

The volute pump housing has an axial inlet port and a radial outlet center-line port. Flange dimensions are in accordance with ASME B16.5.

For 8" outlet and above, the outlet port is tangential.

The pump houses have both a priming and a drain hole closed by plugs.

TM077436

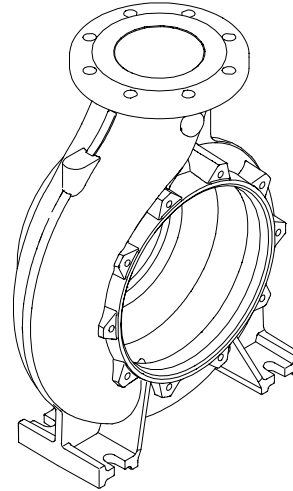

Pump housing with center-line outlet

TM077437

TM030232

TM077438

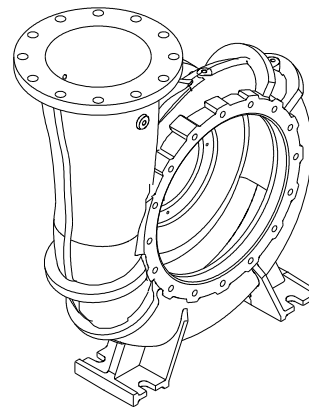

Pump housing with tangential outlet

TM077439

TM077682



## Loose flange

Flanges are available as fixed or loose flanges depending on the pump material. Loose flanges are only available for ductile iron pumps.

A loose flange is a flange which can be adjusted to fit the existing pipes, and be adapted to the required flange standard and thus facilitate installation.

The loose flanges offer quite a few benefits compared to the standard type flanges:

- they save installation time in general.
- they make up for twisted counter flange weldings.
- they provide full adaptability to the standards DIN, ANSI and JIS.
- you will have a flange that will fit the first time you replace an old pump or another brand; loose flanges range from 145 to 580 PSI (10 to 40 bar).
- you can make special installations where the flanges are turned to match limited space for service.

With loose flanges it is possible to turn the flange a few degrees if the counter flange has been twisted during installation and/or welding. The flange can be rotated to meet the connection. This will avoid stress being added to the pump and will reduce overall downtime.

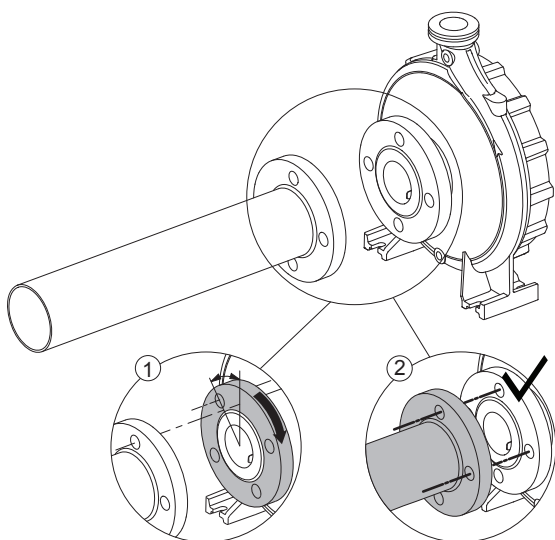

TM060920

Loose flange

## Motor stool and seal cover

The seal cover is provided with a manual air vent for the venting of the pump housing and the shaft seal chamber. The air vent can be replaced with a flush port which connects to a flush line from the pump housing. An O-ring forms the seal between cover and pump housing.

Coupling guards are fitted to the motor stool.

Motor stools are prepared for NEMA foot mounted TC 140-440 motor frames.

## Shaft

The stainless steel shaft is  $\varnothing 28$ ,  $\varnothing 38$ ,  $\varnothing 48$ ,  $\varnothing 55$  or  $\varnothing 60$  where the shaft seal is mounted.

The shaft end where the coupling is fitted is a precision fitting with fine tolerances. This ensures an aligned and trouble-free rotating impeller unit.

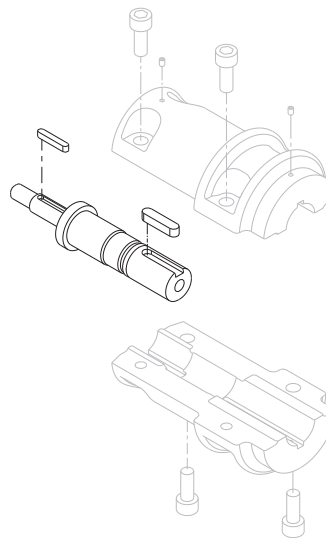

TM07572

Shaft, NBS pump

## Coupling

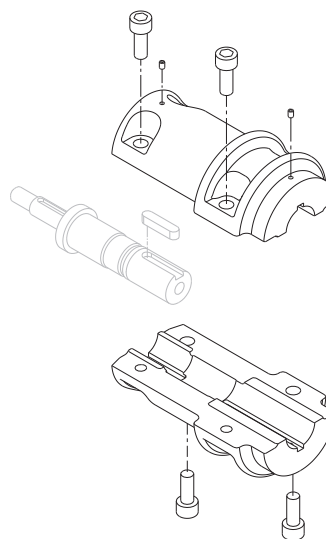

TM07573

Split coupling, NBS pump

The split coupling can be serviced without dismantling the motor from the base and without removing the pump housing from the pipework. This saves realignment of pump and motor after service. Fitting the coupling to the shaft is a precision fit. A tool supplied with the pump ensures this precision fit at all times.

## Impeller

The impeller is a closed impeller with double-curved blades with smooth surfaces. This ensures high efficiency.

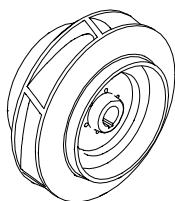

TMI030231

*Impeller, NBS pumps*

All impellers are statically and hydraulically balanced. The hydraulic balancing compensates for axial thrust.

The direction of rotation of the impeller is clockwise when viewed from the motor.

All impellers can be adapted to the duty point as requested by the customer.

## Surface treatment

The assembled pump will have a final layer of paint (4-6 mil inch/100-150 µm) on all external parts.

The color code for the finished product is NCS 9000/AL 9005.

## Test pressure

Pressure testing is made with + 68 °F (20 °C) water containing corrosion inhibitor.

On request, duty point testing is available.

A hydrostatic pressure test is carried out on all pumps at 1.5 times of rated pressure according to HI 14.6:2016 standard.

Hydro-static pressure testing:

Pressure class	Rated pressure		Test pressure	
	[PSI]	[bar]	[PSI]	[bar]
125	175	12	263	18
300	363	25	545	37.5

Duty point performance testing is made according to HI 14.6:2016.

## Motors and drives

For NBS pumps, Grundfos can provide a wide range of motors and drives for the below two categories:

- standard motors
- speed-controlled motors.

Standard motors are mains-operated whereas speed-controlled motors can be started and operated in various ways.

The speed-controlled pumps can be driven in two ways:

- by a standard motor with an external frequency converter. The frequency converter can be a Grundfos CUE or another make from other manufacturers.
- by a motor with an integrated frequency converter (Grundfos MLE motor).

## Standard motors

The motor is a TEFC or ODP standard motor with main dimensions according to NEMA standards. Electrical tolerances are to NEC.

## Motor protection

Three-phase motors must be connected to a motor-protective circuit and/or fuse according to local regulations.

## Energy efficiency classification

The standard motor is NEMA premium.

## Speed-controlled standard motors

## General considerations

If you connect an external frequency converter to your standard motor, the motor insulation is exposed to higher voltage peaks due to the operation of the frequency converter. This causes the motor to be noisier than in normal operation. In addition, large motors are exposed to bearing currents caused by the frequency converter.

If you operate the motor via a frequency converter, consider the following:

- For 2-, 4- and 6-pole motors, 100 hp (75 kW) and above, isolate one of the motor bearings electrically to prevent damaging currents from passing through the motor bearings.

- Installation of grounding rings is also recommended for non-inverter ready motors or motors without shaft grounding rings because it provides a path to ground for the induced shaft voltage by high speed switching frequency of the VFDs which can cause bearing failure. MLE motors do not need grounding rings because they are using patented (EP3185405) solutions.
- In noise-sensitive applications, you can reduce the motor noise by fitting a dU/dt filter between the motor and the frequency converter. For particularly noise-sensitive applications, we recommend a sinusoidal filter.
- The length of the cable between motor and frequency converter affects the motor load. Therefore, check that the cable length meets the specifications laid down by the frequency converter supplier.
- For supply voltages between 500 and 690 V, install a dU/dt filter to reduce voltage peaks, or use a motor with reinforced insulation.
- For supply voltages of 690 V, use a motor with reinforced insulation, and fit a dU/dt filter.

### Grundfos CUE

#### Pumps connected to Grundfos CUE external frequency converters



TM075268

#### Grundfos CUE frequency converters

CUE is a series of frequency converters designed for speed control of a wide range of pumps and applications. Grundfos CUE provides a variety of benefits to the end-user, such as:

- Grundfos E-pump functionality and user interface
- application- and pump family-related functions
- increased comfort compared to fixed-speed pump solutions
- simple and easy installation and commissioning compared to standard frequency converters
- speed control of pumps up to 350 hp (260 kW).

#### Intuitive startup guide

The startup guide enables easy and quick installation and commissioning. CUE startup guide normally starts at first power-on. Here, a number of parameters are set automatically on the basis of the pump type. Other parameters are set manually on the basis of motor and pump nameplate data. The startup guide can be repeated, if necessary.

#### Smart user interface of CUE

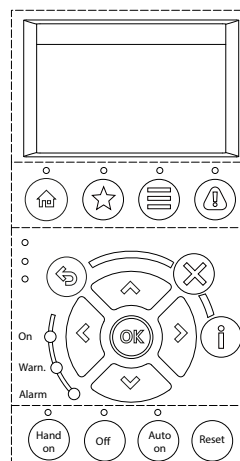

TM077977

#### Grundfos CUE user interface

Grundfos CUE features a unique user-friendly interface with graphic display and easy-to-use buttons.

The user interface offers these possibilities:

- Local operation via an operating panel with graphic display.
- Remote operation via external signals.
- Monitoring of operating status via indicator lights and signal relays.
- Display of alarms or warnings and logging.

#### Controlling the selected parameter

Grundfos CUE has a built-in PI controller offering closed-loop control of these parameters:

- constant differential pressure
- proportional pressure
- constant differential temperature
- constant temperature
- constant flow rate
- constant pressure
- constant level
- constant other value.

#### Wide product range

The CUE product range is quite comprehensive, covering five different voltage ranges, enclosure classes IP20/21 (NEMA 1) and IP54/55 (NEMA 12)\*IP66 (for US market), and a wide range of output powers.

The table below provides a general overview.

Input voltage [V]	Output voltage [V]	Motor [hp] ([kW])
1 x 200-240	3 x 200-240	1.5 - 10 (1.1 - 7.5)
3 x 200-240	3 x 200-240	1-60 (0.75 - 45)
3 x 380-500	3 x 380-500	0.75 - 350 (0.55 - 250)
3 x 525-600	3 x 525-600	1-10 (0.75 - 7.5)
3 x 525-690	3 x 525-690	15-350 (11-250)

## External communication

Grundfos CUE can communicate by means of LON, PROFIBUS, GRM, Cellular, PROFINET, Modbus or BACnet via Grundfos CIU.

## Grundfos MLE motors

NBSE are pumps with motor and integrated frequency converters.

The Grundfos MLE utilizes a Permanent Magnet Synchronous Motor (PMSM) which carries an IE5 rating based on European Commission standards. This IE5 rating exceeds the current NEMA Premium Efficiency standard.



TM077942

*NBSE pump*

The MLE motor is a totally enclosed, fan-cooled, frequency-controlled motor with dimensions according to NEMA standards. Electrical tolerances are to IEC 60034 and NEMA.

### Motor protection

The motor requires no external motor protection. MLE motors incorporate thermal protection against overload and stalled condition. The Motor is also protected against power supply transient voltages in accordance with EN-61800-3.

### Benefits

Grundfos MLE motors provide a variety of benefits to the end-user, such as:

- Grundfos E-pump functionality and user interface
- a perfect match between pump and frequency drive
- application- and pump family-related functions
- increased comfort compared to fixed-speed pump solutions
- simple installation and commissioning compared to standard frequency converters.

### Smart user interface of MLE



TM078031

Grundfos MLE motors feature a user-friendly interface with easy-to-use buttons. See section Operating panel.

#### Controlling the selected parameter

Grundfos MLE has a built-in PI controller offering closed-loop control of these parameters:

- constant differential pressure
- proportional differential pressure
- constant temperature
- constant flow rate
- constant pressure
- constant differential temperature
- constant level
- constant curve
- constant other value.

### External communication

Grundfos MLE can communicate by means of LON, PROFIBUS, Cellular, GRM, PROFINET, Modbus or BACnet as described in section Communication with E-pumps.

#### Related information

[Communication with E-pumps](#)  
[21. Grundfos Product Center](#)

### Optional motors

The Grundfos standard range of motors covers a wide variety of application requirements. However, for special applications or operating conditions, custom-built motor solutions can be provided.

For special applications or operating conditions, Grundfos offers custom-built motors such as:

- ATEX-approved motors
- ML motors with anti-condensation heating unit
- motors with thermal protection.

## 7. Operating conditions

### Ambient temperature and installation altitude

The ambient temperature and the installation altitude are important factors for the motor.

All motors are able to operate without power derating for temperatures up to +104 °F (+40 °C) or below altitude of 3280.8 ft (1000 m) above sea level. Above these two limits, it may be necessary to use a motor with a higher output, or de-rated. Contact the motor manufacturer if the motor is to be operated above these limits. Consult the motor manufacturer before operating the motor above these limits.

### Liquid temperature

Liquids with temperatures ranging from -10 to 284 °F (-25 to +140 °C) are covered in this data booklet.

The maximum liquid temperature is stamped on the nameplate, and depends on the shaft seal chosen.

Note that the maximum liquid temperature limits stated by Grundfos may be overruled by local regulations and various laws.

### Flow rates

#### Minimum flow rate

The pump must not run against a closed valve as it causes an increase in temperature and a formation of steam in the pump. That may result in shaft damage, impeller erosion, short life of bearings and damage to the stuffing boxes or mechanical shaft seals due to stress or vibration. The continuous stable flow rate must be at least 10 % of the rated flow rate. The rated flow rate is stated on the pump nameplate.

#### Maximum flow rate

Do not exceed the maximum flow rate, otherwise there is a risk of cavitation or overload, for instance.

The minimum and maximum flow rates are indicated either on the performance curve pages, or on a curve for a specific pump when selecting it in the Grundfos Product Center. See [www.grundfos.com](http://www.grundfos.com).

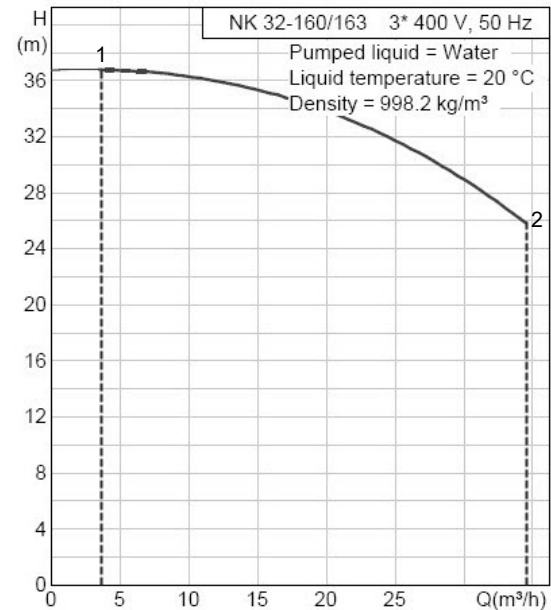

TM051652

Example from Grundfos Product Center showing minimum and maximum flow rate

Pos.	Description
1	Minimum flow rate
2	Maximum flow rate

## Pressures in the pump

### Maximum operating pressure

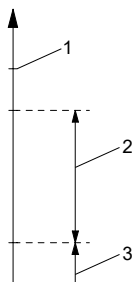

TM075513

### Pressures in the pump

Pos.	Description
1	Maximum operating pressure (pressure above atmospheric pressure)
2	Pump pressure
3	Inlet pressure

The total value of the inlet pressure and the pump pressure must be lower than the maximum operating pressure stated on the pump nameplate. Operation against a closed valve gives the highest operating pressure.

### Minimum inlet pressure

Monitor the minimum inlet pressure to avoid cavitation. The risk of cavitation is higher in the following situations:

- The liquid temperature is high.
- The flow rate is considerably higher than the rated flow rate of the pump.
- The pump is operating in an open system with suction lift.

### Maximum inlet pressure

The total value of the inlet pressure and the pump pressure must be lower than the maximum operating pressure stated on the pump nameplate. Operation against a closed valve yields the highest operating pressure.

## Suction lift in open systems

### Calculation of suction lift in open systems (water)

The suction lift "H" in feet head required during operation to avoid cavitation in the pump can be calculated by means of the following formula:

$$H = p_b \times 2.31 - \text{NPSH} - H_f - H_v$$

<b>H</b>	Suction lift
<b>p<sub>b</sub></b>	Barometric pressure in PSI. The barometric pressure can be taken as equal to 14.5 PSI. In closed systems, p <sub>b</sub> indicates system pressure in PSI.
<b>NPSH</b>	Net Positive Suction Head in feet head. The NPSH value can be read from the NPSH curve at the highest flow rate the pump will be delivering. The maximum flow rate must not exceed the maximum flow rate shown on the QH curve. The NPSH curve and QH curve for the individual pump can be found in Grundfos Product Center and in the relevant data booklet.
<b>H<sub>f</sub></b>	Friction loss in the inlet pipe in feet head at the highest flow rate the pump will be delivering.
<b>H<sub>v</sub></b>	Vapor pressure in feet head. See figure below.

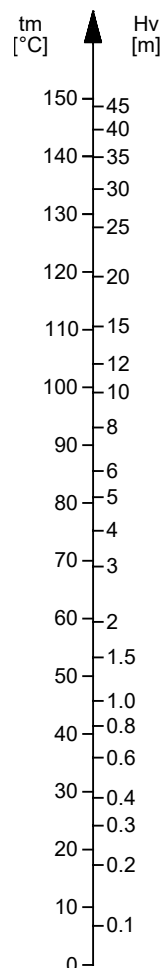

TM003037

Relation between liquid temperature and vapor pressure

## How to determine the vapor pressure in feet

Step 1: Degree C = (Degree F - 32) / 1.8

Step 2: Vapor pressure from meter to feet: 1 meter = 3.28 feet.

## Positive H value

### Example:

Liquid temperature:	68 °F (20 °C)
Pump size:	NBS 030-110
Flow rate:	550 GPM
$p_b$ :	14.5 PSI
NPSH:	15 ft head
$H_f$ :	9 ft head
$H_v$ :	1 ft head
$H = p_b \times 2.31 - \text{NPSH} - H_f - H_v$ [ft head]	
$H = 14.5 \times 2.31 - 15 - 9 - 1 = 8.5$ ft head	

If the calculated value of H is positive, the pump can operate with a maximum suction lift of H feet.

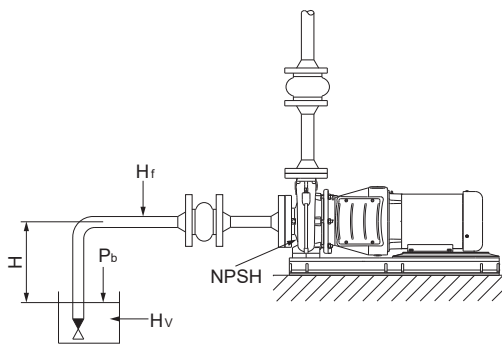

Suction lift with positive H

TM077936

## Negative H value

### Example:

Liquid temperature:	194 °F (90 °C)
Pump size:	NBS 030-110
Flow rate:	550 GPM
$p_b$ :	14.5 PSI
NPSH:	15 ft head
$H_f$ :	9 ft head
$H_v$ :	23.6 ft head
$H = p_b \times 2.31 - \text{NPSH} - H_f - H_v$ [ft head]	
$H = 14.5 \times 2.31 - 15 - 9 - 23.6 = -14.1$ ft head	

If the calculated value of H is negative, a minimum suction head of H feet is required. The calculated H must be present during operation.

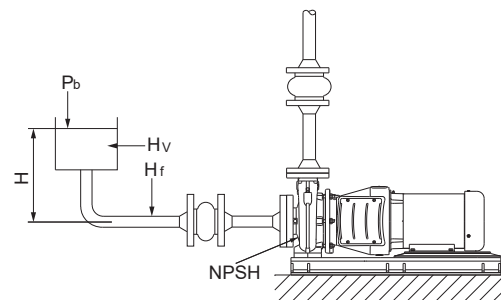



Suction lift with negative H

TM077937



## Operating range of mechanical shaft seals

The operating range of the seals is described for two main applications: pumping of water or pumping of coolants. Seals with a temperature range of 32 °F (0 °C) and up are mainly used for pumping water, while seals for temperatures below 32 °F (0 °C) are mainly intended for coolants.

Shaft seal diameter [mm]				28, 38	48	55	60	
Shaft seal type	Seal faces	Rubber	Code	Temperature range	Maximum pressure [PSI] ([bar])			
 Bellows seal, type B, unbalanced	BQ <sub>7</sub>	FKM	BBQV	32-194 °F (0-90 °C)	232 (16)	232 (16)	232 (16)	232 (16)
	Q <sub>7</sub> Q <sub>7</sub>	EPDM	BQQE	-13 to +248 °F (-25 to +120 °C)	232 (16)	232 (16)	232 (16)	232 (16)
	Q <sub>7</sub> Q <sub>7</sub>	FKM	BQQV	14 to 194 °F (-10 to +90 °C)	232 (16)	232 (16)	232 (16)	232 (16)
 O-ring seal, type D, balanced	AQ <sub>7</sub>	FKM	DAQF	32-284 °F (0-140 °C)	363 (25)	363 (25)	363 (25)	363 (25)
	Q <sub>6</sub> Q <sub>7</sub>	EPDM	DQQE	-4 to +284 °F (-20 to +140 °C)	363 (25)	363 (25)	363 (25)	363 (25)

### Recommended shaft seal for water-glycol mixture

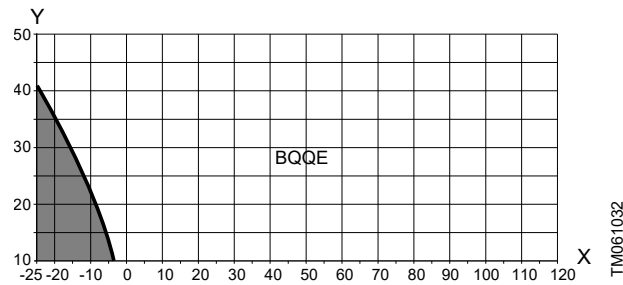

TM061032

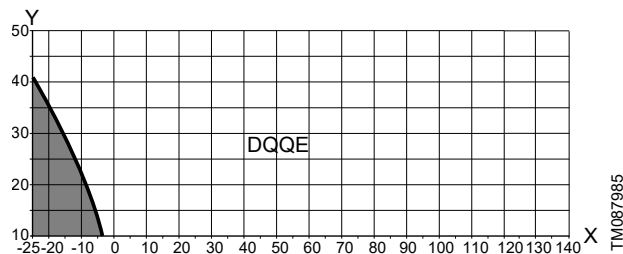

TM087985

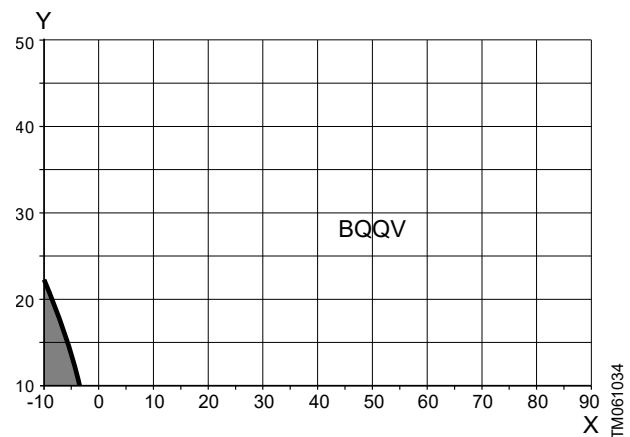

TM061034

#### Operating range of EPDM shaft seals

Pos.	Description
X	Temperature [°C]
Y	Glycol content [%]

#### Operating range of FKM shaft seals

Pos.	Description
X	Temperature [°C]
Y	Glycol content [%]

**Carbon and silicon carbide (xAQx), (xBQx)**

Mechanical shaft seals with carbon-silicon carbide seal faces have a wide range of applications and are especially suitable if there is risk of dry running and/or if the temperature is high. These mechanical shaft seals are not suitable for liquids containing abrasive particles as the carbon parts will be worn. At temperatures below 32 °F (0 °C), corrosion inhibitors containing abrasive particles are usually added to the pumped liquid, and these seals will thus not be suitable.

**Note:** The antimony impregnation (A) is not approved for potable water applications.

**Silicon carbide and silicon carbide (xQQx)**

Mechanical shaft seals with silicon carbide-silicon carbide seal faces also have a very wide range of applications. These seals are very resistant to abrasive particles and well suited at liquid temperatures up to 194 °F (90 °C) for Q<sub>1</sub> types, and up to 120 °C for Q<sub>6</sub> types. At higher temperatures, the reduced lubricating properties of the pumped liquid may cause noise problems and limit the life of the seal faces.

**EPDM (xxxE)**

Mechanical shaft seals with EPDM (xxxE) rubber are primarily suitable for water.

If the water contains oil or if chemicals or other liquids than water are pumped, you may have to replace the rubber parts of the mechanical shaft seal.

**FKM (xxxV)**

Mechanical shaft seals with FKM (xxxV) rubber have excellent resistance against oil and a number of chemicals.

# 8. Mechanical installation

## Installation requirements

### Pump location

The pump must be sited in a well-ventilated, but frost-free location.

### Minimum clearance

For inspection and repair, allow suitable clearance for pump and motor removal.

- Pumps fitted with motors up to and including 4 kW (5 hp) require a 12 inches (0.3 m) clearance behind the motor.

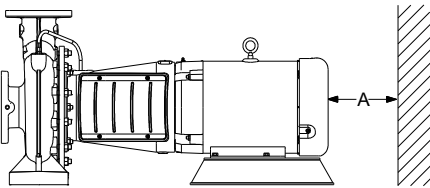

- Pumps fitted with motors of 7.5 hp (5.5 kW) and up require a 12 inches (0.3 m) clearance behind the motor and at least a clearance of 40 inches (1 m) above the motor to allow for the use of lifting equipment. A is minimum 12 inches (0.3 m), B is minimum 40 inches (1 m). See the figure below.

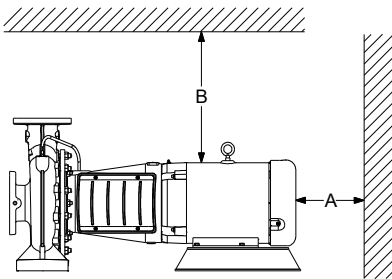

### Installation positions

Arrows on the pump housing show the direction of the flow of liquid through the pump.

Only horizontal installation is allowed for NBS pumps. Contact Grundfos for information on extra installation requirements if special installation positions are needed.

The motor must never be positioned below the horizontal plane. Horizontal motors with feet must always be supported.

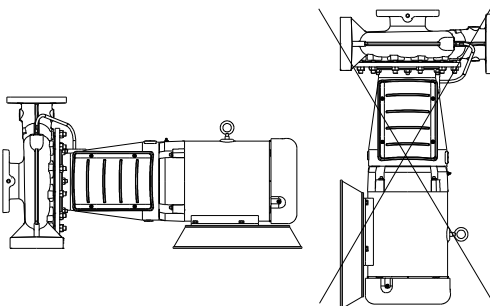

## Foundation

- We recommend that you install the pump on a flat concrete foundation that is heavy enough to provide permanent support for the entire pump.
- The foundation must be adequate for absorbing any vibration, normal strain or shock.
- The foundation may float on springs or be a raised part of the floor.
- Optimally, the weight of the concrete foundation must be at least 1.5 times the weight of the pump.
- The foundation must have a completely even surface.
- The foundation length and width must always be 8 inches (200 mm) larger than the length and width of the pump. See the figure below.

TM075314

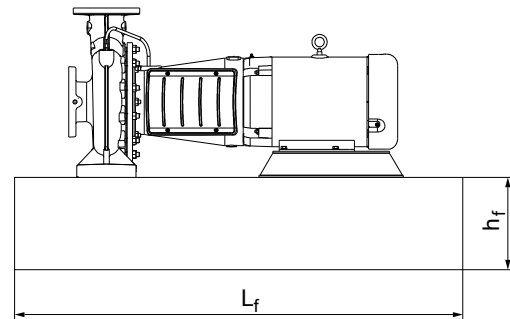

TM075399

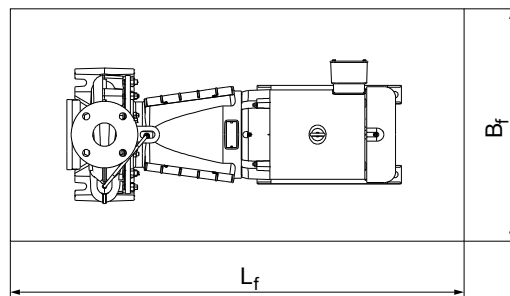

TM075315

The minimum height of the foundation, indicated by hf, can be calculated with the following formula:

$$h_f = \frac{m_{\text{pump}} \times 1.5}{L_f \times B_f \times \delta_{\text{concrete}}}$$

hf	Height of the foundation [in] ([m])
Lf	Length of the foundation [in] ([m])
Bf	Width of the foundation [in] ([m])
mpump	Mass of the pump [lbs] ([kg])
δconcrete	Density of the concrete [lb/in <sup>3</sup> ] ([kg/m <sup>3</sup> ])

The density (δ) of concrete is usually taken as 0.08 lb/in<sup>3</sup> (2200 kg/m<sup>3</sup>).

- In installations where noiseless operation is particularly important, we recommend a foundation with a mass up to 5 times that of the pump.

TM075316

## Preparing the foundation

We recommend the following procedures to ensure a good foundation:

1. Pour the foundation without interruption to 0.75 to 1.25 inches (19 to 32 mm) of the final level. Use an approved, non-shrinking concrete. Contact your concrete supplier for advice if any doubts.
2. Use vibrators to ensure that the concrete is evenly distributed. The top surface must be well scored and grooved before the concrete sets. This provides a bonding surface for the grout.
3. Embed anchor bolts in the concrete. Allow enough bolt length to reach through grout, shims, the lower part of the support rail, nuts and washers.

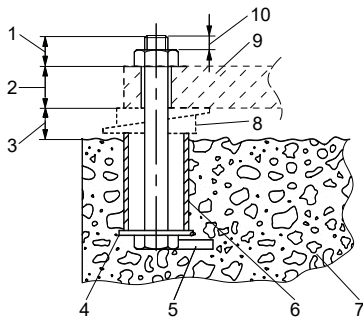

TM075514

Pos.	Description
1	Bolt length above the support rail
2	Thickness of the support rail
3	0.75 - 1.25 in. (19-32 mm) allowance for grout
4	Washer
5	Lug
6	Pipe sleeve
7	Foundation with rough top
8	Wedges and shims left in place
9	Support rail
10	0.2 - 0.4 in. (5-10 mm)

4. Let the foundation cure for several days before levelling and grouting the support rail.
5. Apply grout if needed. NBS pumps do not require grouting to maintain shaft alignment, but grouting will increase pump stability within the pipe system. Grouting compensates for an uneven foundation, distributes the weight of the unit, dampens vibrations and prevents shifting. Use an approved, non-shrinking grout. If you have questions or doubts about the grouting, please contact an expert on grouting.

## Levelling of the product without base frame

1. Level the pump shaft and the flanges by using a spirit level and adjusting the wedges or shims as required.

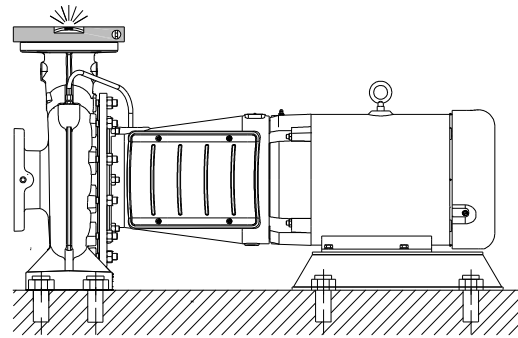

TM075331

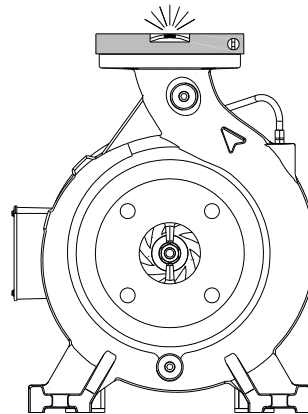

TM075332

2. Tighten the anchor bolt nuts. Make sure the piping can be aligned to the pump flanges without putting strain on the pipes or the flanges.

## Levelling of the product with base frame

1. Lift or jack up the base frame to the final level, 0.75 - 1.26 inches (19-32 mm) above the concrete foundation. Level the pump shaft and flanges by using a spirit level and adjusting the wedges or shims, as required. A indicates an allowance of 0.75 - 1.26 inches (19-32 mm). See the figure below.

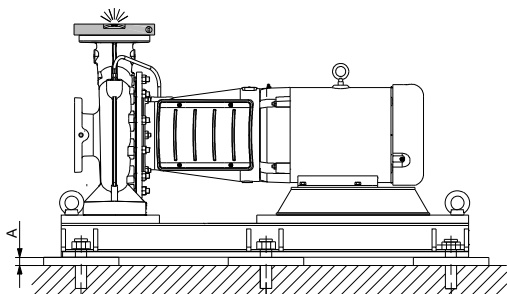

TM075317

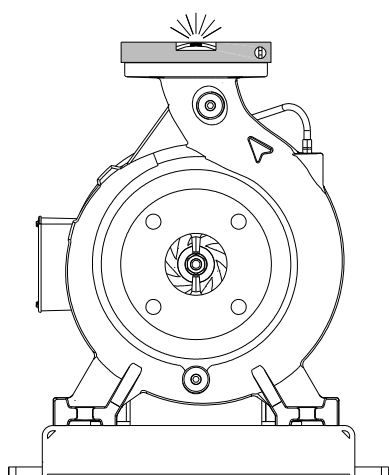

TM075318

2. Tighten the anchor bolt nuts. Make sure the piping can be aligned to the pump flanges without putting strain on the pipes or the flanges.

## Pipes and connections

### Pipe system

When installing the pipes, the pump housing must not be stressed by the pipes.

The inlet and outlet pipes must be of an adequate size, taking the pump inlet pressure into account.

The pipes must be installed in a way that air pockets are avoided, especially on the inlet side of the pump.

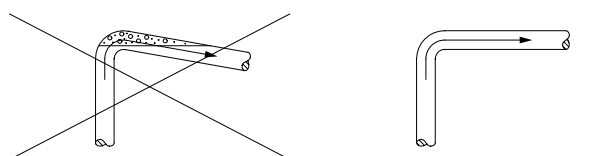
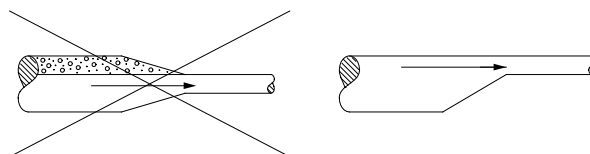

TM002263

### Pipelines

The pipes must be as straight as possible, so as to avoid unnecessary bends and fittings. Where necessary, use 45° or long-sweep 90° pipe bends to decrease friction loss.

Where flanged joints are used, internal diameters must match properly and mounting holes must be aligned.

### Connecting the inlet pipes

- Run the inlet pipe as direct as possible, and optimally, make sure the length is at least ten times the pipe diameter. A short inlet pipe can be the same diameter as the inlet port. A long inlet pipe must be one or two sizes larger than the inlet port, depending on the length, and with a reducer between the pipe and the inlet port.
- If possible, run a horizontal inlet line along an even gradient. We recommend a gradual upward slope to the pump under suction lift conditions, and a gradual downward slope under positive inlet pressure conditions.
- Avoid any high points, such as pipe loops, as this may create air pockets and throttle the system, or cause erratic pumping.
- Install a valve on the inlet line to allow for isolation of the pump during shutdown and maintenance, and to facilitate pump removal. Where two or more pumps are connected to the same inlet line, install valves to isolate each pump from the line.
- Always install valves in positions that do not yield air pockets.
- During pumping operation, the valves on the inlet line must always be fully open.

## Connecting the outlet pipes

We recommend that you use long horizontal outlet pipes.

- Install a valve near the outlet port to allow for isolation of the pump during shutdown and maintenance, and to facilitate pump removal.
- Avoid high points in the outlet pipe because it might entrap air or gas, and thus retard pump operation.
- If water hammer occurs, for example when check valves are used, close the outlet valve before pump shutdown.
- Make sure the pipes are adequately supported as close to the pump as possible, both on the inlet and the outlet side.

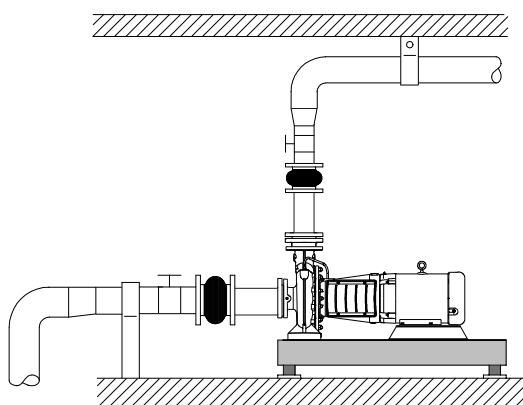

TM075319

*Pump installation*

The counterflanges must be properly aligned so that the pump is not strained while the flange bolts are tightened.

## Condensation cover

When installing the pumps outdoors, provide the motor with a suitable cover to protect the pump and motor against the direct effects of the elements.

When mounting the condensation cover on top of the motor, make sure to leave enough space for the air to cool the motor.

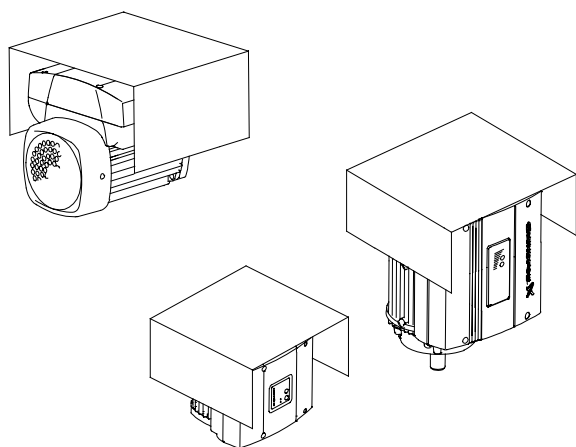

TM079060

*Motors with condensation cover*

## Expansion joints

Expansion joints provide these advantages:

- absorption of thermal expansion and contraction of pipes caused by variations in liquid temperature
- reduction of mechanical influences in connection with pressure surges in the pipes
- isolation of structure-borne noise in the pipes, applying only to rubber bellows expansion joints.

**Note:** Do not install expansion joints to make up for inaccuracies in the pipework, such as center displacement or misalignment of flanges.

The expansion joints must be fitted at a minimum distance of 1 to 1.5 times of the pipe diameter away from the pump on the inlet and the outlet side. This will prevent turbulence in the expansion joints, thus ensuring optimum inlet conditions and minimum pressure loss on the outlet side. At flow velocities greater than 16.4 ft/s (5 m/s), we recommend that you fit larger expansion joints matching the pipes.

The figures below show examples of rubber bellows expansion joints with or without limiting rods.



TM024979



TM024981

*Rubber bellows expansion joints with and without limiting rods*

We always recommend that you use expansion joints with limiting rods for flanges larger than DN 100 in order to reduce the effects of the expansion or contraction forces on the pipes.

Follow the supplier's instructions and pass them on to advisers or pipe installers.

You must anchor the pipes in such a way that they do not stress the expansion joints and the pump.

The figure below shows an example of a metal bellows expansion joint with limiting rods.

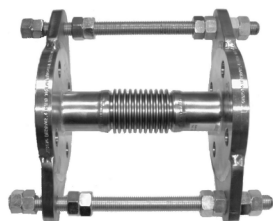

TM024980

*Metal bellows expansion joint with limiting rods*

Due to the risk of rupture of the rubber bellows, we recommend that you use metal bellows expansion joints at temperatures above 212 °F (100 °C) combined with high pressure.

## Measuring instruments

### Pressure gauge and manovacuum gauge

To ensure continuous monitoring of the operation, we recommend that you install a pressure gauge on the outlet side and a manovacuum gauge on the inlet side. The pressure gauge tapings must only be opened for test purposes.

The measuring range of the gauges must be 20 % above the maximum pump pressure. When measuring with pressure gauge on the pump flanges, note that a pressure gauge does not register dynamic pressure.

On all pumps, the diameters of the inlet and outlet flanges are different which results in different flow velocities at the two flanges. Consequently, the pressure gauge on the outlet flange will not show the pressure stated in the technical documentation, but a value which may be up to 22 PSI (1.5 bar) or approximately 50 ft (15 m) of head lower.

### Ammeter

We recommend connecting an ammeter to check the motor load.

## 9. Speed-controlled pumps

NBS pumps are available using Grundfos MLE motors with integrated speed control. These pumps are also called E-pumps and the pump designation is NBSE.

E-pumps are suitable for applications where the pressure, temperature, flow rate or another parameter is to be controlled on the basis of signals from a sensor at the pump or at some other strategic point in the system.



NBSE pumps without sensors from the factory

E-pump type	Medium speed 4000 RPM	Low speed 2200 RPM
NBSE	3 - 30 hp (2.2 - 22 kW)	1.5 - 30 hp (1.1 - 22 kW)

E-pumps with the above mentioned motor sizes can operate at medium speed (4000 RPM) or at low speed (2200 RPM).

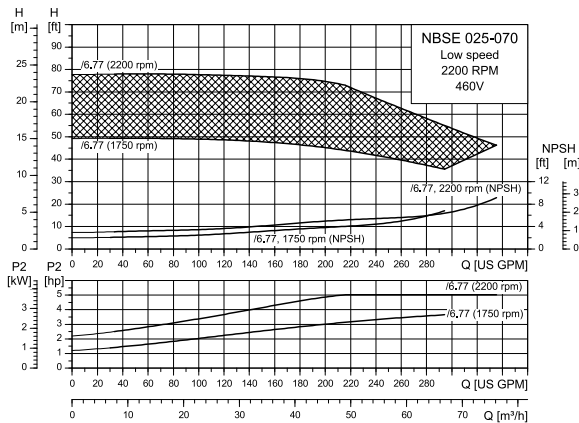

Example: NBSE 025-070

This pump size uses a 5 HP motor for both a fixed speed pump and for the speed controlled pump. The speed of the E-pump having a 6.77 inch impeller trim can be increased to 2200 RPM for part of the flow range until the motor reaches its power limit (around 215 GPM). When this happens the E-pump motor maintains max power output to the max flow of the pump – illustrated by a linear curve for both Flow-Head and Flow-Power performance. The fixed speed pump operates at approximately 1750 RPM.

This means that having the same hydraulic design you will get a considerably larger performance area, and the E-pump is able to deliver higher head and flow rate with the same motor size.

### E-pumps in connection with a CUE

Pumps with 6-pole motors or 2-pole and 4-pole motors larger than 30 hp can be connected to a Grundfos CUE or an external frequency converter.

The external speed control enables the pump to operate at any duty point between 25 % and 100 % speed. The performance adapts to current conditions and keeps the energy consumption at a minimum.

The 100 % curve corresponds to the curve of a pump with a mains-operated motor.

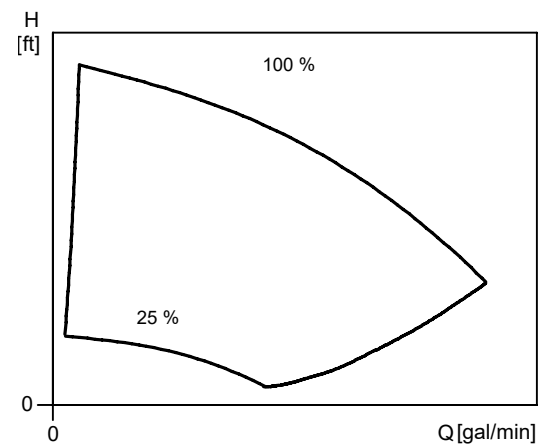

Duty range of E-pumps in connection with a CUE

TM077942

TM081072

TM081059



## Why select an E-pump

The main reasons for choosing a Grundfos E-motor instead of a conventional standard motor and separate frequency converter are listed as below:

1. Unique product
  - The motor and frequency converter are perfectly matched. The customer will not experience the same problems which may occur when using a standard motor with separate frequency converter, such as noise due to switch frequency.
  - Predefined intelligent control modes, such as constant pressure and constant level. These predefined control modes make it easy to fit the pump into any application.
2. Full application adaptation
  - Functionality is matched to the specific pump application.
  - Grundfos makes a customized configuration file to suit the customer's requirements.
  - Full adaptation to any control management system by means of various interfaces.
3. Simple and easy installation
  - Reduced installation and wiring costs compared to standard frequency converters.
  - Box product, ready for direct installation and use with preconfigured parameters.
  - No further programming required. An E-motor is a plug-and-pump product.
  - On-site customization of the software configuration file to adapt to changed operating parameters.
  - Control, monitor, install, commission, and email reports all from your smart device via the Grundfos GO technology.
4. One supplier
  - Complete product is supplied by one sole supplier. This gives the customer security as only one supplier needs to be contacted in case of problems or complaints.
5. Intelligence
  - New benefits by new advanced features and functions
6. Energy saving due to very high efficiencies
  - All motors much higher than IE4 and complete PDS (Power Drive System) high in IES2
7. Integrated solution
  - Ensure compactness and easy replacement from non-E to E product
8. Customization
  - All functional modules, user interfaces and CIM modules which can be customized to suit your needs
9. Low maintenance cost
  - High quality and high reliability - focus on avoiding bearing currents
10. Remote controllable
  - Build in communication card as well as Grundfos GO.

## Maximum speed of the impeller

For stainless steel impellers the limit is 4000 RPM regardless of impeller size.

### Affinity equations

Normally, NBSE pumps are used in applications characterized by a variable flow. Consequently, it is not possible to select a pump that is constantly operating at its optimum efficiency.

To achieve optimum operating economy, select the pump on the basis of the following criteria:

- The maximum duty point required must be as close as possible to the nominal speed QH curve of the pump.
- The flow rate at the duty point required must be close to the optimum efficiency (eta) for most operating hours.

Between the minimum and maximum performance curve, NBSE pumps have an infinite number of performance curves each representing a specific speed. It may therefore not be possible to select a duty point close to the maximum curve.

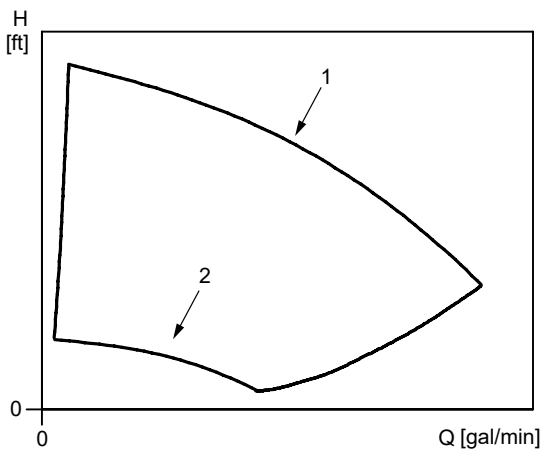

TM081071

Minimum and maximum performance curves

Pos.	Description
1	Maximum curve
2	Minimum curve

In situations where it is not possible to select a duty point close to the maximum curve, use the affinity equations below. The head (H), the flow rate (Q) and the input power (P) are the appropriate variables you need to be able to calculate the motor speed (n).

**Note:** The approximated formulas apply on condition that the system characteristic remains unchanged for  $n_n$  and  $n_x$  and that it is based on the formula  $H = k \times Q^2$ , where k is a constant.

The power equation implies that the pump efficiency is unchanged at the two speeds. In practice, this is not quite correct.

Finally, it is worth noting that the efficiencies of the frequency converter and the motor must be taken into account if a precise calculation of the power saving resulting from a reduction of the pump speed is wanted.

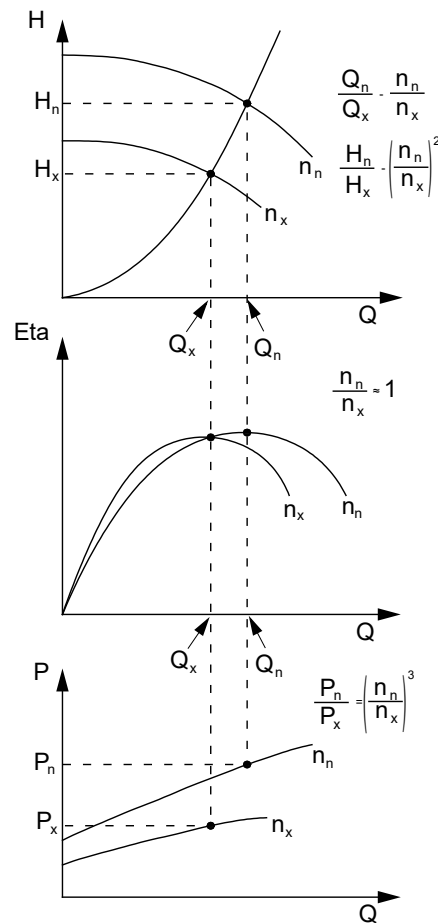

TM008720

#### Affinity equations

$H_n$	Rated head in m
$H_x$	Actual head in m
$Q_n$	Rated flow rate in gal/min ( $m^3/h$ )
$Q_x$	Actual flow rate in gal/min ( $m^3/h$ )
$P_n$	Rated input power in hp (kW)
$P_x$	Actual input power in hp (kW)
$n_n$	Rated motor speed in $min^{-1}$
$n_x$	Actual motor speed in $min^{-1}$
$\eta_n$	Rated efficiency in %
$\eta_x$	Actual efficiency in %

## Communication with the E-solution

	E-solution	
	MLE	CUE
Operating panel on unit	x	x
Grundfos GO control	x	-
Central building management system	x	x

### Operating panel for MLE

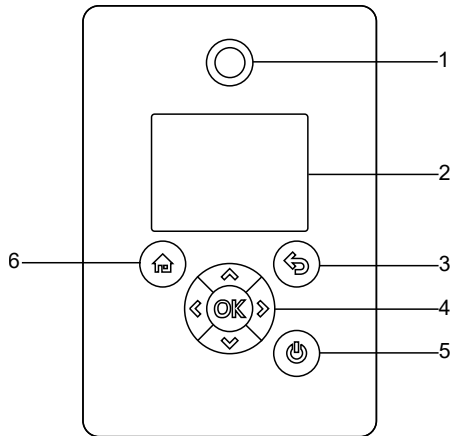

TM054849

#### Advanced control panel

Pos.	Symbol	Description
1		Grundfos Eye The indicator light shows the operating status of the pump.
2	-	Graphical color display.
3		Press the button to go one step back.

- Press the button to navigate between main menus, displays and digits.  
When you change the menu, the display always shows the top display of the new menu.
- Press the buttons to navigate between submenus or change value settings.  
**Note:** If you have disabled the possibility to make settings with the "Enable/disable settings" function, then you can enable it again temporarily by pressing these buttons simultaneously for at least 5 seconds.
- 4

Press the button to save changed values, reset alarms and expand the value field.  
The button enables radio communication with Grundfos GO and other products of the same type.  
When you try to establish radio communication between the pump and Grundfos GO or another pump, the green indicator light in Grundfos Eye flashes. A note also appears in the pump display stating that a wireless device wants to connect to the pump. Press on the pump control panel to allow radio communication with Grundfos GO and other products of the same type.
- Press the button to make the pump ready for operation or to start and stop the pump.  
**Start:**  
If you press the button when the pump is stopped, the pump will only start if no other functions with higher priority have been enabled.  
**Stop:**  
If you press the button when the pump is running, the pump always stops. When you stop the pump via this button, the icon appears in the bottom of the display.
- 5
- 6

Press the button to go to the "Home" menu.

## Remote control

### Grundfos GO

#### Grundfos GO, up to 15 hp medium speed and 10 hp low speed

The pump is designed for wireless radio or infrared communication with Grundfos GO.

Grundfos GO enables setting of functions and gives access to status overviews, technical product information and actual operating parameters.

Grundfos GO offers the following mobile interface, MI.

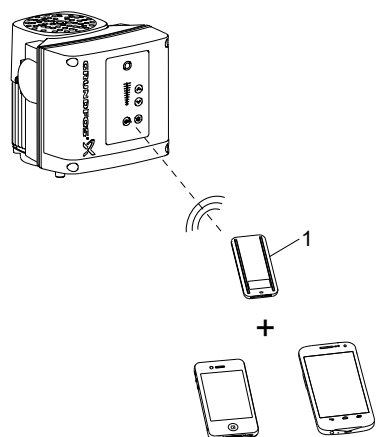

TM066256

*Grundfos GO communicating with the pump via radio or infrared connection, IR*

Pos.	Description
1	Grundfos MI 301: Separate module enabling radio or infrared communication. You can use the module in conjunction with an Android or iOS-based smart device with Bluetooth connection.

#### Grundfos GO, from 20-30 hp medium speed and 15-30 hp low speed

The product is designed for wireless communication with Grundfos GO using Bluetooth (BLE).

Grundfos GO enables you to set functions and gives you access to status overviews, technical product information and current operating parameters.

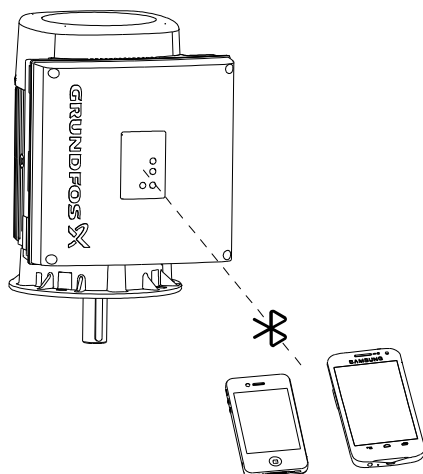

TM082930

## Communication

When Grundfos GO initiates communication with the pump, the indicator light in the middle of Grundfos Eye flashes green. See section Priority of settings.

Furthermore, on pumps fitted with an advanced control panel a text appears in the display saying that a wireless device is trying to establish connection. Press **OK** on the pump in order to establish connection with Grundfos GO or press **Home** to reject connection.

Establish communication using one of these communication types:

- radio communication
- infrared communication
- Bluetooth communication

## Communication with E-pumps

Communication with E-pumps is possible via a central building management system, remote control (Grundfos GO) or operating panel.

### Central building management system

The operator can communicate with an E-pump at a distance by means of the CIU or CIM. Communication can take place via a central building management system allowing the operator to monitor and change control modes and setpoint settings.

The CIU unit can be used for all E-pumps and CIM module can only be used for pumps with MGE/MLE motors. Both can be ordered as accessory. For ordering details, see section CIU communication interface units and CIM communication interface modules.

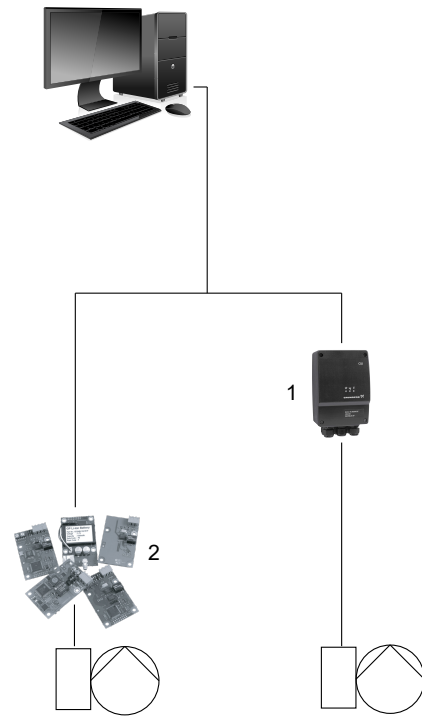

TM058607

Structure of a central building management system

Pos.	Description	
1	CIU 100: LonWorks	
	CIU 150: PROFIBUS DP	
	CIU 200: Modbus RTU	
	CIU 250: GSM	
	CIU 270: GRM	
	CIU 300: BACnet MS/TP	
	CIU 500: Modbus TCP	
	CIU 500: PROFINET IO	
	2	CIM 100: LonWorks
		CIM 150: PROFIBUS DP
CIM 200: Modbus RTU		
CIM 260: 3G/4G cellular		
CIM 280: GRM GiC 3G/4G		
CIM 300: BACnet MS/TP		
CIM 500: PROFINET		
CIM 500: Modbus TCP		
CIM 500: BACnet IP		
CIM 500: EtherNet/IP		
CIM 500: GRM IP		

## 10. Pumps connected in parallel

### Control of pumps connected in parallel

In some applications, parallel pump operation is required for one or more of the following reasons:

- One pump cannot achieve the required performance or flow rate.
- Standby capacity is required to ensure reliability of supply.
- Overall efficiency needs to be improved in case of big variations in the flow rate demand.

NBS, NBSE pumps connected in parallel can be controlled by Control MPC.



Control MPC

### Pumps connected to Control MPC

Pumps can be connected directly to Grundfos Control MPC.

Control MPC incorporates, among others, a CU 352 controller that can control up to six pumps.

By means of an external sensor, Control MPC can ensure optimum adaptation of the performance to the demand by closed-loop control of these parameters:

- proportional differential pressure
- constant differential pressure
- differential pressure, remote
- flow rate
- temperature.

CU 352 incorporates features such as those below:

#### Startup wizard

Correct installation and commissioning is a prerequisite for attaining optimum performance of the system and trouble-free operation year in and year out.

During commissioning of the system, a startup wizard is shown on the display of the CU 352. The wizard guides the operator through the various steps via a series of dialogue boxes to ensure that all settings are done in the correct sequence.

#### Application-optimized software

CU 352 incorporates application-optimized software which helps you set your system to the application in question.

Furthermore, you can easily navigate through the menus of the controller. You do not need any training to be able to set and monitor the system.

#### Ethernet connection

CU 352 incorporates an Ethernet connection which makes it possible to get full and unlimited access to the setting and monitoring of the system via a remote PC.

#### Service port, GENI TTL

The service port of the CU 352 enables easy access to updating software and data logging in service situations.

#### External communication

Control MPC enables communication with other fieldbus protocols. In order to communicate with other fieldbus protocols, a GENIbus module and a gateway is needed. Control MPC can communicate with LON, PROFIBUS, Modbus or BACnet via Grundfos CIM or CIU.

**Note:** For further information about Control MPC, see the "Control MPC" data booklet. The data booklet is available in Grundfos Product Center on [www.grundfos.com](http://www.grundfos.com). For further information on Grundfos Product Center, see section Grundfos Product Center.

TMO40210\_SH

## 11. Selection of product

### Pump size

Select the pump size on the basis of these conditions:

- required flow rate and pressure at the draw-off point
- pressure loss as a result of height differences
- friction loss in the pipes. It may be necessary to account for pressure loss in connection with long pipes, bends or valves, etc.
- optimum efficiency at the estimated duty point.

### Efficiency

If you expect the pump to always operate at the same duty point, select a pump which operates at a duty point corresponding to the optimum efficiency of the pump.

In case of controlled operation or varying consumption, select a pump whose optimum efficiency falls within the duty range covering the greater part of the duty time.

### Material

Select the material variant on the basis of the liquid to be pumped. See section Pumped liquids.

### Related information

[12. Pumped liquids](#)

## 12. Pumped liquids

We recommend NBS pumps for thin, clean and non-explosive liquids not containing solid particles or fibres, such as water and water with glycol, pool water, sea water or brackish water.

Liquids with temperatures ranging from -13 to +284 °F (-25 to +140 °C) are covered in this data booklet.



# 13. Pump flange dimensions

## Fixed pump flanges, ASME/ANSI B16.1

ASME/ANSI B16.1 is the standard used for cast iron pump flanges and flange fittings, classes 125 and 250.

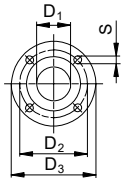

Class 125											
Nominal diameter [inch]											
D <sub>1</sub>	1 1/4	1 1/2	2	2 1/2	3	4	5	6	8	10	12
D <sub>2</sub>	3 1/2	3 7/8	4 3/4	5 1/2	6	7 1/2	8 1/2	9 1/2	11 3/4	14 1/4	17
D <sub>3</sub>	4 5/8	5	6	7	7 1/2	9	10	11	13 1/2	16	19
S	4 x $\varnothing$ 5/8	4 x $\varnothing$ 5/8	4 x $\varnothing$ 3/4	4 x $\varnothing$ 3/4	4 x $\varnothing$ 3/4	8 x $\varnothing$ 3/4	8 x $\varnothing$ 7/8	8 x $\varnothing$ 7/8	8 x $\varnothing$ 7/8	12 x $\varnothing$ 1	12 x $\varnothing$ 1
Thickness	0.51	0.59	0.67	0.72	0.78	0.98	0.97	1.03	1.13	1.22	1.25

## Loose pump flanges, ASME/ANSI B16.42

ASME/ANSI B16.42 is the standard used for ductile iron flanges and flanged fittings, classes 150 and 300.

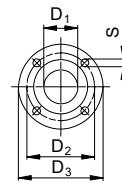

Class 300											
Nominal diameter [inch]											
D <sub>1</sub>	1 1/2	2	2 1/2	3	4	5	6	8	10	12	
D <sub>2</sub>	4 1/2	5	5 7/8	6 5/8	7 7/8	9 1/4	10 5/8	13	15 1/4	17 3/4	
D <sub>3</sub>	6 1/8	6 1/2	7 1/2	8 1/4	10	11	12 1/2	15	17 1/2	20 1/2	
S	4 x $\varnothing$ 7/8	8 x $\varnothing$ 3/4	8 x $\varnothing$ 7/8	8 x $\varnothing$ 7/8	8 x $\varnothing$ 7/8	8 x $\varnothing$ 7/8	12 x $\varnothing$ 7/8	12 x $\varnothing$ 1	16 x $\varnothing$ 1 1/8	16 x $\varnothing$ 1 1/4	
Thickness	0.71	0.81	0.94	0.98	0.98	1.02	1.10	1.34	1.57	1.81	

# 14. Introduction to curves and technical data

## How to read the curve charts

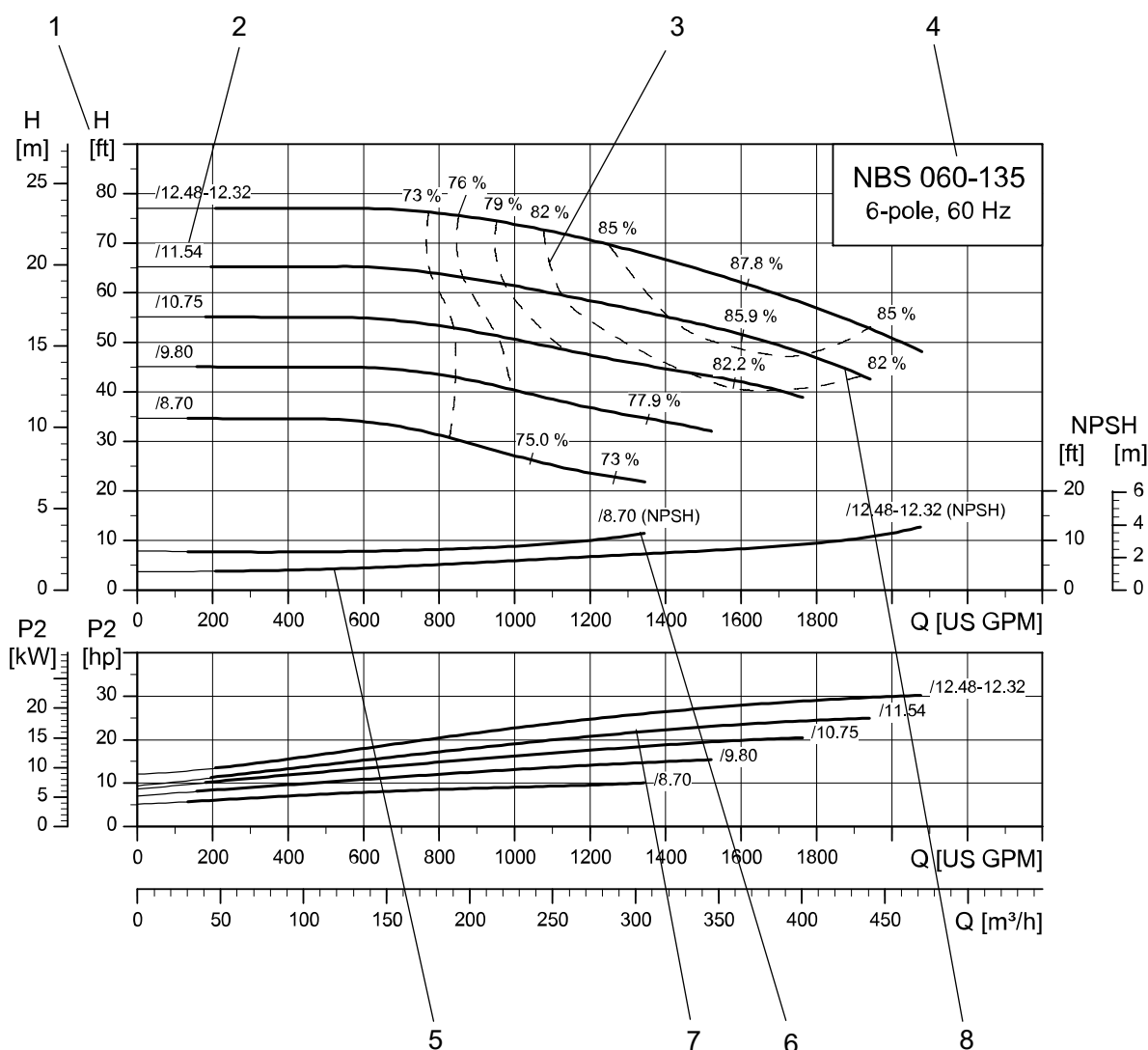

TM080594

Pos.	Description
1	Total pump head, H [ft] or H [m] is equal to H <sub>total</sub>
2	Impeller diameter [inch]
3	Hydraulic efficiency curves are shown as dashed lines, eta [%]
4	Pump size, pole number and frequency
5	The NPSH curve is shown for maximum impeller size.
6	The NPSH curve is shown for minimum impeller size.
7	The power curve indicates pump input power P2 [hp]
8	QH curve for the individual pump. The bold curve indicates the recommended performance range.

The shown pump performance curves in section Performance curves represent the pump in combination with a NEMA Premium Baldor motor or a NEMA Super Premium MLE motor.

### Related information

[NBSE pumps with speed-controlled motors](#)

## Curve conditions

The guidelines below apply to the curves shown in the performance charts shown in section Performance curves.

- Tolerances are according to HI 14.6:2016.
- The curves show pump performance with different impeller diameters at the nominal speed.
- The bold part of the curves shows the recommended operating range.
- We do not recommend the thin parts as the possible operating range here might suggest the selection of a smaller or larger pump size.
- Do not use the pumps at minimum flow rates below  $0.1 \times Q_{\max}$  because of the danger of overheating the pump.
- The curves apply to the pumping of water at a temperature of 68 °F (20 °C) and a kinematic viscosity of 1 mm<sup>2</sup>/s (1 cSt).
- Eta: The dashed lines show values of the hydraulic efficiency of the pump.
- NPSH: The curves show maximum values measured under the same conditions as the performance curves.
- In case of a specific gravity other than that of water at 68 °F (0.036 lb/in<sup>3</sup>), the outlet pressure is proportional to the specific gravity.
- When pumping liquids with a specific gravity higher than 1000 kg/m<sup>3</sup> (0.036 lb/in<sup>3</sup>), motors with correspondingly higher outputs must be used.

### Calculation of total head

The total pump head consists of the height difference between the measuring points + the differential head + the dynamic head.

$$H_{total} = H_{geo} + H_{stat} + H_{dyn}$$

---

$H_{geo}$  Height difference between measuring points.

---

$H_{stat}$  Differential head between the inlet and outlet sides of the pump.

---

$H_{dyn}$  Calculated values based on the velocity of the pumped liquid on the inlet and outlet sides of the pump.

---

### Related information

[NBSE pumps with speed-controlled motors](#)

## Pump performance testing

NBS testers are all capable of performing hydraulic performance tests according to HI 14.6:2016 requirements.

The standard HI 14.6:2016 sets standards for "rotodynamic pumps, Hydraulic performance acceptance tests, Grades 1, 2 and 3".

### Performance acceptance grades

Six pump-performance-test acceptance grades, 3B, 2B, 2U, 1B, 1E and 1U are defined in HI 14.6:2016.

Acceptance grade	Mandatory measurements		Optional measurements	
	Q	H	P1	Eta-tot
3B	± 9 %	± 7 %	+ 9 %	- 7 %
2B	± 8 %	± 5 %	+ 8 %	- 5 %
2U	+ 16 %	+ 10 %	+ 16 %	
1B	± 5 %	± 3 %	+ 4 %	- 3 %
1E	± 5 %	± 3 %	+ 4 %	≥ 0 %
1U	+ 10 %	+ 6 %	+ 10 %	

---

Q: Flow

---

H: Head

---

P1: Total consumed power

---

Eta-tot: Total efficiency

---

These tolerance grades can be used in the contract between the pump manufacturer and the purchaser, or they can be used in a default tolerance factor which will apply if no specific tolerance grade has been agreed between the manufacturer and the customer.

The performance acceptance grades are explained in section Specifying acceptance grades and Acceptance grades and tolerances, showing the performance grades related to an ordinary pump curve.

### Related information

[Specifying acceptance grades](#)

[Acceptance grades and tolerances](#)

### The guarantee points

According to HI 14.6:2016 the acceptance-grade tolerance applies to one guarantee point.

A guarantee point is defined by a guaranteed flow and a guaranteed head.

In addition, either minimum total efficiency or maximum total input power may be guaranteed at the specified conditions.

This means that the standard sets guidelines for a duty point guaranteed for the following:

- Q and H - or
- Q, H and total efficiency (Eta-total) - or
- Q, H and total consumed power (P1).

The guarantee point is defined by a minimum of five measured test points.

Example on a duty point test living up to HI 14.6:2016 requirements

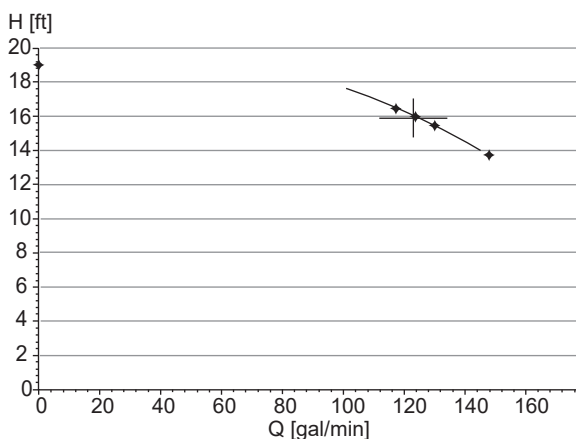

Five measured test points are used to verify one guarantee point

TM070448

### Evaluation of performance

The test must show that the measured pump curve touches or passes through a tolerance surrounding the guarantee point, as defined by the selected acceptance grade.

Guarantee-point evaluation must be made at the rated speed, which for NBS pumps means 60 Hz.

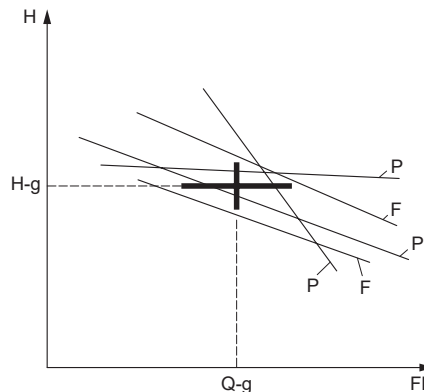

TM071544

Pump curves that either pass or fail to cross the tolerance cross of the guarantee point

Pos.	Description
Q-g	Q-guaranteed
H-g	H-guaranteed
P	Pass
F	Fail
H	Head
FL	Flow

## Performance-test types

A duty point test can be made for NBS pumps.

### Tests carried out on pumps

- Tests are saved for at least five years and can be traced using the pump's unique serial number.
- It is not possible to change acceptance grade on an already tested and supplied pump - if this should be required a re-test of the pump is needed.
- Witness testing can be arranged.

### Duty-point-verification test, Grades 2B, 3B, 2U, 1B, 1E and 1U

This test method offers the possibility to perform a duty-point verification of the following:

- Q and H - or
- Q, H and total efficiency (Eta-tot) - or
- Q, H and total consumed power (P1).

Acceptance grade	Mandatory measurements		Optional measurements	
	Q	H	P1	Eta-tot
2B	Standard		Refer to factory	
3B	Refer to factory		Refer to factory	
2U				
1B	Refer to factory		Refer to factory	
1E				
1U				

What Grundfos is able to guarantee for the different acceptance grades will be evaluated case by case. Contact your local sales company on this.

Grundfos makes duty-point verification according to HI 14.6:2016 for one guarantee point at full speed, 60 Hz. The customer must tell Grundfos which duty point to verify. If no duty point is specified by the customer, the performance is validated in BEP (best efficiency point). The requested duty point is verified by five measured points. If more points are to be tested in addition to the five test points to verify duty point, this must be stated in the order.

A maximum of 9 evenly distributed test points are available.

#### Grade 2B duty-point verification

The following example illustrates performance testing according to Grade 2B.

Flow and head are mandatory and efficiency or power consumption, P1, is optional.

Tolerances for a Grade 2B test are as follows:

- Flow:  $\pm 8 \%$
- Head:  $\pm 5 \%$
- Efficiency:  $- 5 \%$ , only equal to or better than the guaranteed value
- P1:  $+ 8 \%$

#### Q and H are tested and verified

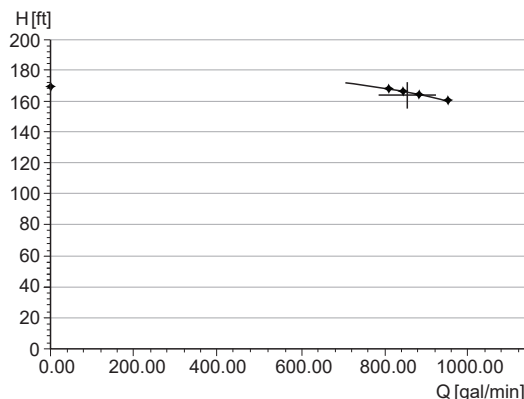

TM078005

Measured values for flow and head

#### Grade 1B duty-point verification

The following example illustrates performance testing according to Grade 1B.

Flow and head are mandatory and efficiency or power consumption, P1, is optional.

Tolerances for a Grade 1B test are as follows:

- Flow:  $\pm 5 \%$
- Head:  $\pm 3 \%$
- Efficiency:  $- 3 \%$ , only equal to or better than the guaranteed value
- P1:  $+ 4 \%$

#### Q, H and Eta-tot are tested and verified

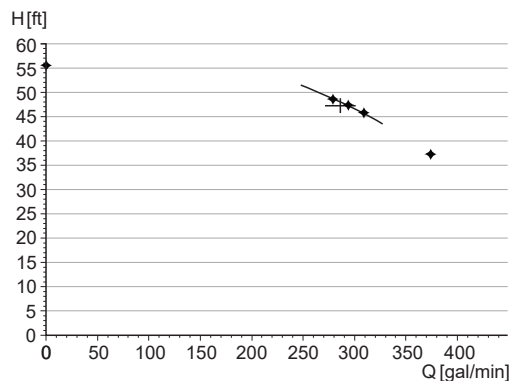

TM078003

Measured values for flow and head

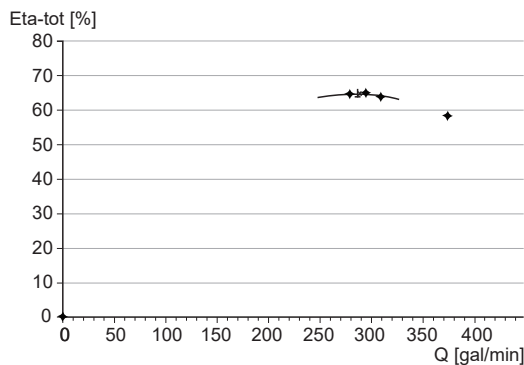

TM078004

Measured values for total efficiency

### Grade 1U duty-point verification

The following example illustrates performance testing according to Grade 1U.

Flow and head are mandatory and efficiency or power consumption, P1, is optional.

Tolerances for a Grade 1U test are as follows:

- Flow: + 10 %
- Head: + 6 %
- Efficiency: 0 %, only equal to or better than the guaranteed value
- P1: + 10 %

### Q, H and P1 are tested and verified

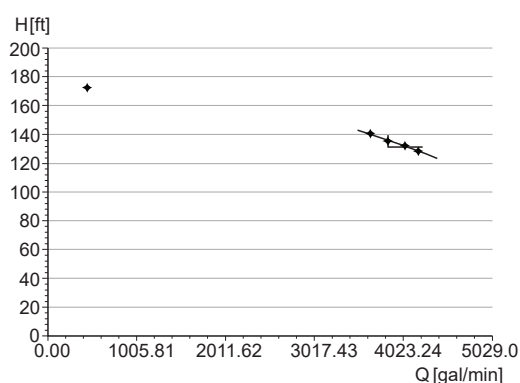

Measured values for flow and head

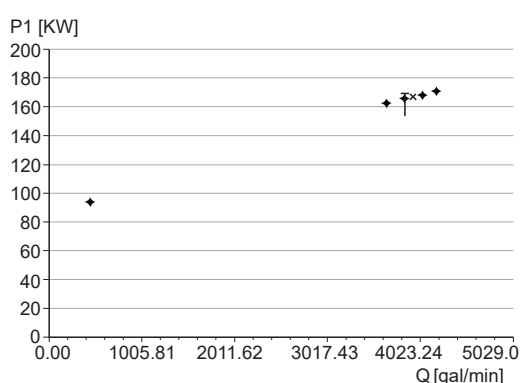

Measured values for consumed power

### Static high pressure test

All produced pumps undergo a static high pressure test of 1.5 x PN (pressure rating of the pump).

## Specifying acceptance grades

The graphs in section Acceptance grades and tolerances show the tolerances as stated in the standard, related to an ordinary pump curve. The graphs also show which pump performance to expect if the customer, having the same pump to start with, orders a pump with the same guarantee point for different tolerances (B, E or U) within the acceptance grades.

In some cases it will not be possible to fulfil the same guarantee point for a unilateral tolerance as it will for a bilateral tolerance. This is indicated by the lowered curve for "E" and "U" grades.

If the requested guarantee point is the same for a Grade U pump as for a Grade B pump, the consequence of the production tolerances could result in a larger pump being required to obtain the requested duty point.

What Grundfos is able to guarantee for the different acceptance grades will be evaluated case by case. Contact your local sales company on this.

### Related information

[Acceptance grades and tolerances](#)

## Acceptance grades and tolerances

### Acceptance grade B

This acceptance grade refers to grades with a bilateral tolerance on flow and head and with a tolerance on efficiency.

### Acceptance grade E

This acceptance grade refers to a grade with a bilateral tolerance on flow and head but without tolerance on efficiency.

### Acceptance grade U

This acceptance grade refers to a grade with a unilateral tolerance on flow and head. For the 2U grade there is a tolerance on efficiency. For the 1U grade there is no tolerance on efficiency.

Note that if the acceptance grade changes from Grade 1B to 1U, the customer does not necessarily get a better pump with a higher efficiency. More likely, he gets a pump where the performance is always to the positive side of the guarantee point.

TM078061

TM078062

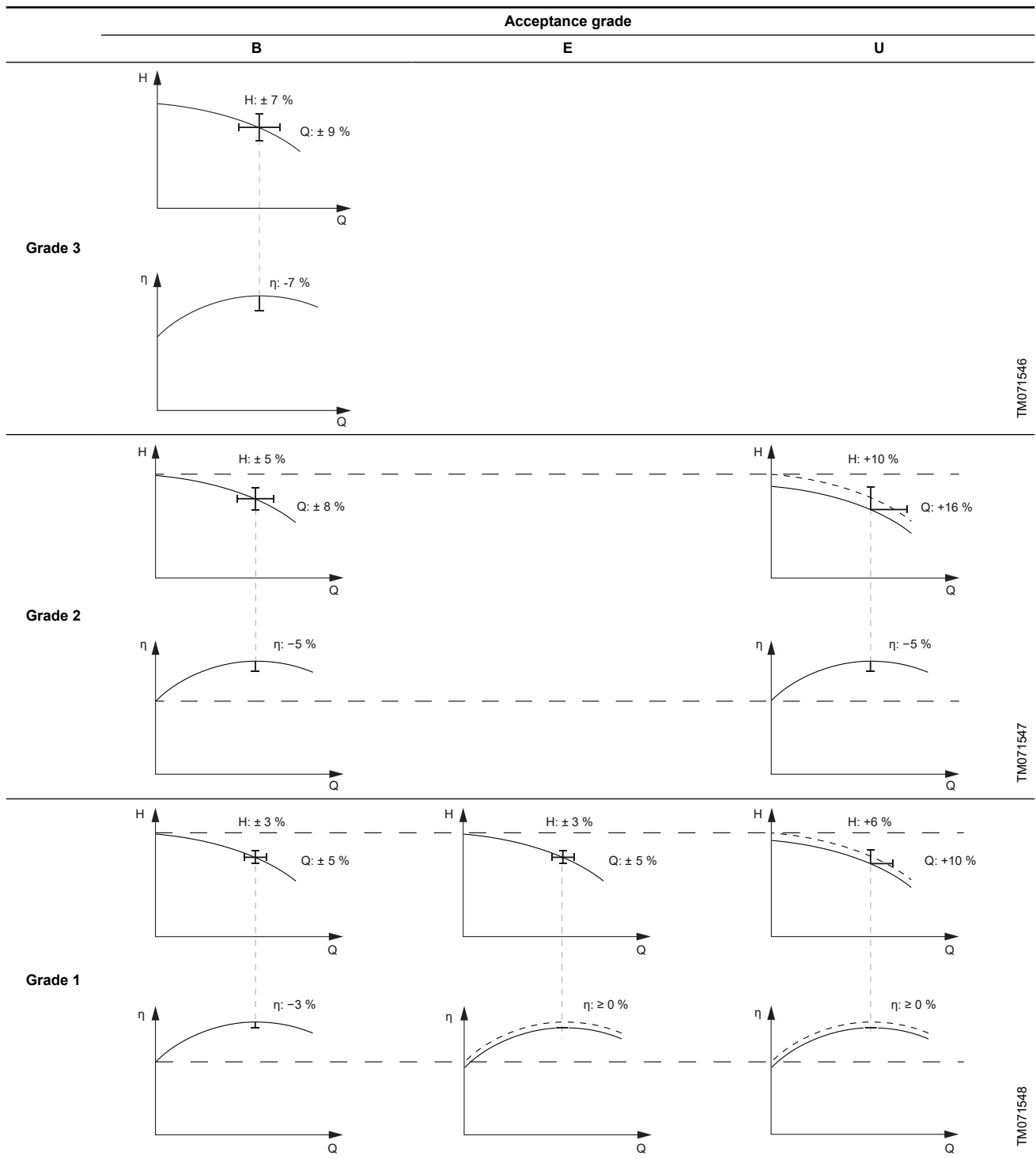

TM071546

TM071547

TM071548

# 15. Performance curves

## Overview

### NBSE pumps with speed-controlled motors

Pump size	Medium speed	Low speed
NBSE 012-070	See <a href="#">NBSE 012-070</a>	See <a href="#">012-070</a>
NBSE 015-070	See <a href="#">NBSE 015-070</a>	See <a href="#">015-070</a>
NBSE 015-090	See <a href="#">NBSE 015-090</a>	See <a href="#">015-090</a>
NBSE 015-095	See <a href="#">NBSE 015-095</a>	See <a href="#">015-095</a>
NBSE 020-095	See <a href="#">NBSE 020-095</a>	See <a href="#">020-095</a>
NBSE 020-110	-	See <a href="#">020-110</a>
NBSE 020-135	-	See <a href="#">020-135</a>
NBSE 025-070	See <a href="#">NBSE 025-070</a>	See <a href="#">025-070</a>
NBSE 025-095	See <a href="#">NBSE 025-095</a>	See <a href="#">025-095</a>
NBSE 025-110	-	See <a href="#">025-110</a>
NBSE 030-070	See <a href="#">NBSE 030-070</a>	See <a href="#">030-070</a>
NBSE 030-095	-	See <a href="#">030-095</a>
NBSE 030-110	-	See <a href="#">030-110</a>
NBSE 030-135	-	See <a href="#">030-135</a>
NBSE 040-070	See <a href="#">NBSE 040-070</a>	See <a href="#">040-070</a>
NBSE 040-095	-	See <a href="#">040-095</a>
NBSE 040-110	-	See <a href="#">040-110</a>
NBSE 040-135	-	See <a href="#">040-135</a>
NBSE 050-070	See <a href="#">NBSE 050-070</a>	See <a href="#">050-070</a>
NBSE 050-095	-	See <a href="#">050-095</a>
NBSE 050-110	-	See <a href="#">050-110</a>
NBSE 060-095	-	See <a href="#">060-095</a>
NBSE 060-110	-	See <a href="#">060-110</a>

### NBS pumps with fixed-speed motors

Pump size	2-pole	4-pole	6-pole
NBS 012-070	See <a href="#">NBS 012-070</a>	See <a href="#">NBS 012-070</a>	-
NBS 015-070	See <a href="#">NBS 015-070</a>	See <a href="#">NBS 015-070</a>	-
NBS 015-090	See <a href="#">NBS 015-090</a>	See <a href="#">NBS 015-090</a>	-
NBS 015-095	See <a href="#">NBS 015-095</a>	See <a href="#">NBS 015-095</a>	-
NBS 020-095	See <a href="#">NBS 020-095</a>	See <a href="#">NBS 020-095</a>	-
NBS 020-110	-	See <a href="#">NBS 020-110</a>	-
NBS 020-135	-	See <a href="#">NBS 020-135</a>	-
NBS 025-070	See <a href="#">NBS 025-070</a>	See <a href="#">NBS 025-070</a>	-
NBS 025-095	See <a href="#">NBS 025-095</a>	See <a href="#">NBS 025-095</a>	See <a href="#">NBS 025-095</a>
NBS 025-110	-	See <a href="#">NBS 025-110</a>	See <a href="#">NBS 025-095</a>
NBS 030-070	See <a href="#">NBS 030-070</a>	See <a href="#">NBS 030-070</a>	-
NBS 030-095	See <a href="#">NBS 030-095</a>	See <a href="#">NBS 030-095</a>	See <a href="#">NBS 030-095</a>
NBS 030-110	-	See <a href="#">NBS 030-110</a>	See <a href="#">NBS 030-110</a>
NBS 030-135	-	See <a href="#">NBS 030-135</a>	See <a href="#">NBS 030-135</a>
NBS 040-070	See <a href="#">NBS 040-070</a>	See <a href="#">NBS 040-070</a>	See <a href="#">NBS 040-070</a>
NBS 040-095	See <a href="#">NBS 040-095</a>	See <a href="#">NBS 040-095</a>	See <a href="#">NBS 040-095</a>
NBS 040-110	-	See <a href="#">NBS 040-110</a>	See <a href="#">NBS 040-110</a>
NBS 040-135	-	See <a href="#">NBS 040-135</a>	See <a href="#">NBS 040-135</a>
NBS 040-150	-	See <a href="#">NBS 040-150</a>	See <a href="#">NBS 040-150</a>
NBS 050-070	See <a href="#">NBS 050-070</a>	See <a href="#">NBS 050-070</a>	See <a href="#">NBS 050-070</a>
NBS 050-095	-	See <a href="#">NBS 050-095</a>	See <a href="#">NBS 050-095</a>
NBS 050-110	-	See <a href="#">NBS 050-110</a>	See <a href="#">NBS 050-110</a>



<b>Pump size</b>	<b>2-pole</b>	<b>4-pole</b>	<b>6-pole</b>
NBS 050-135	-	See <a href="#">NBS 050-135</a>	See <a href="#">NBS 050-135</a>
NBS 050-150	-	See <a href="#">NBS 050-150</a>	See <a href="#">NBS 050-150</a>
NBS 060-095	-	See <a href="#">NBS 060-095</a>	See <a href="#">NBS 060-095</a>
NBS 060-110	-	See <a href="#">NBS 060-110</a>	See <a href="#">NBS 060-110</a>
NBS 060-135	-	See <a href="#">NBS 060-135</a>	See <a href="#">NBS 060-135</a>
NBS 060-150	-	See <a href="#">NBS 060-150</a>	See <a href="#">NBS 060-150</a>
NBS 080-135	-	See <a href="#">NBS 080-135</a>	See <a href="#">NBS 080-135</a>
NBS 080-150	-	See <a href="#">NBS 080-150</a>	See <a href="#">NBS 080-150</a>
NBS 100-150	-	See <a href="#">NBS 100-150</a>	See <a href="#">NBS 100-150</a>

### Medium speed, 4000 RPM

#### NBSE 012-070

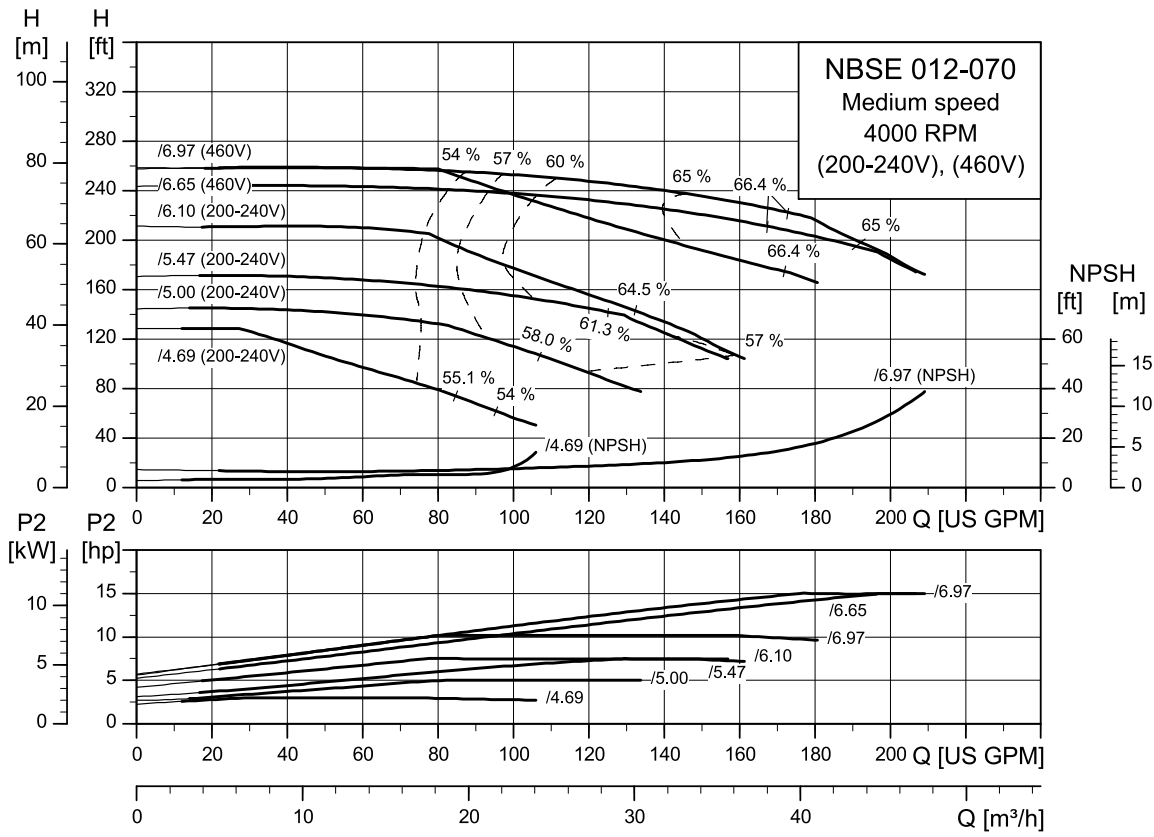

TM080526

#### NBSE 015-070

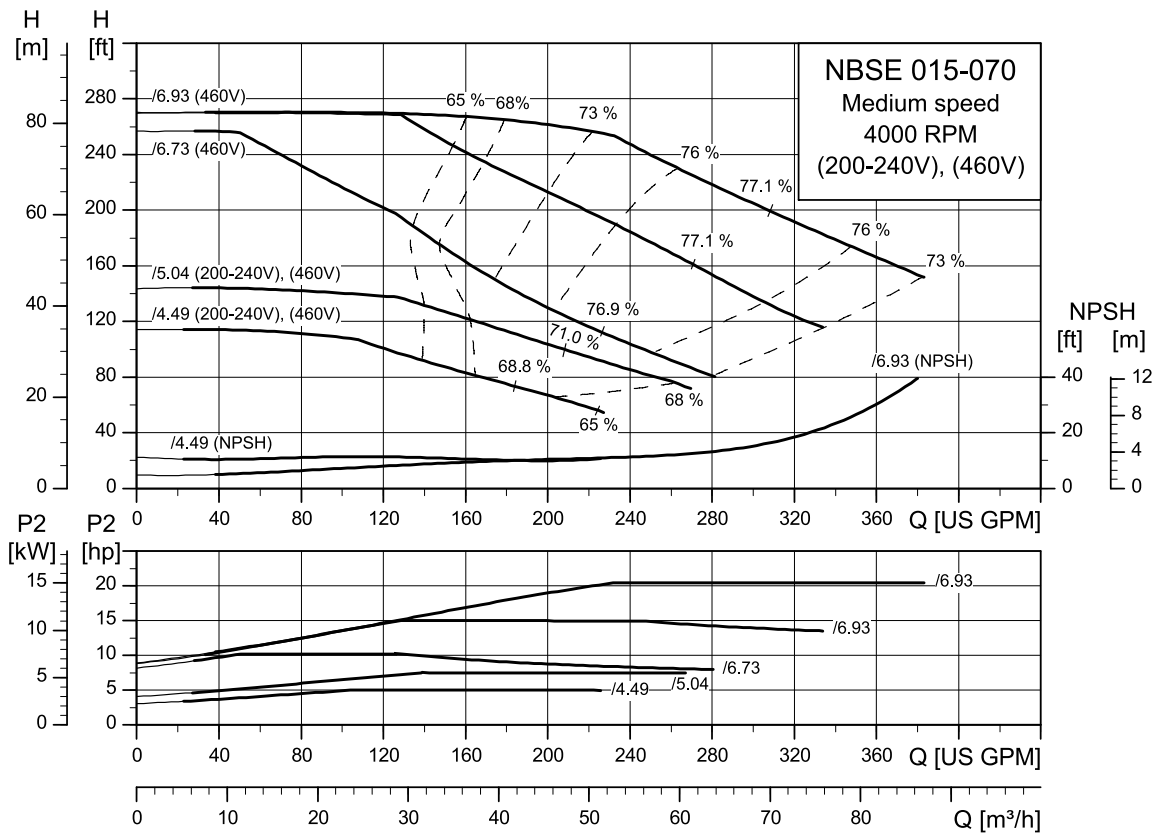

TM080527

**NBSE 015-090**

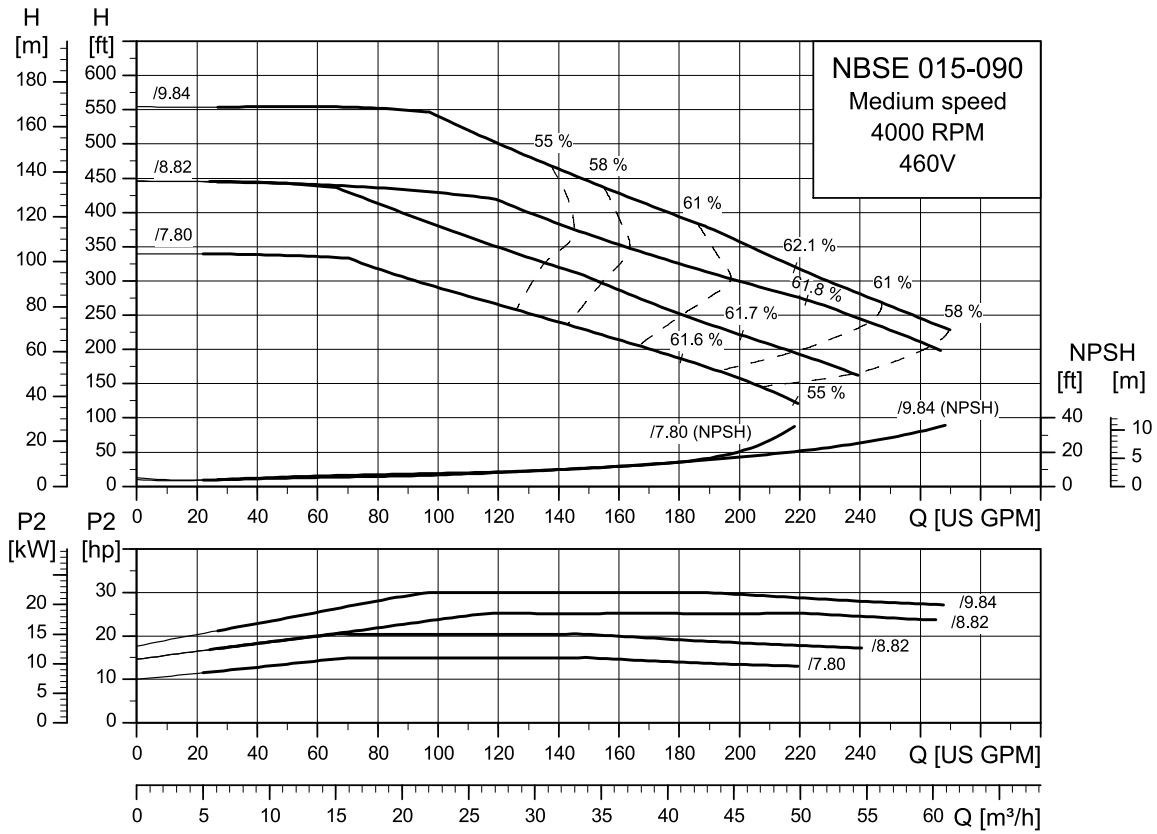

TM087598

**NBSE 015-095**

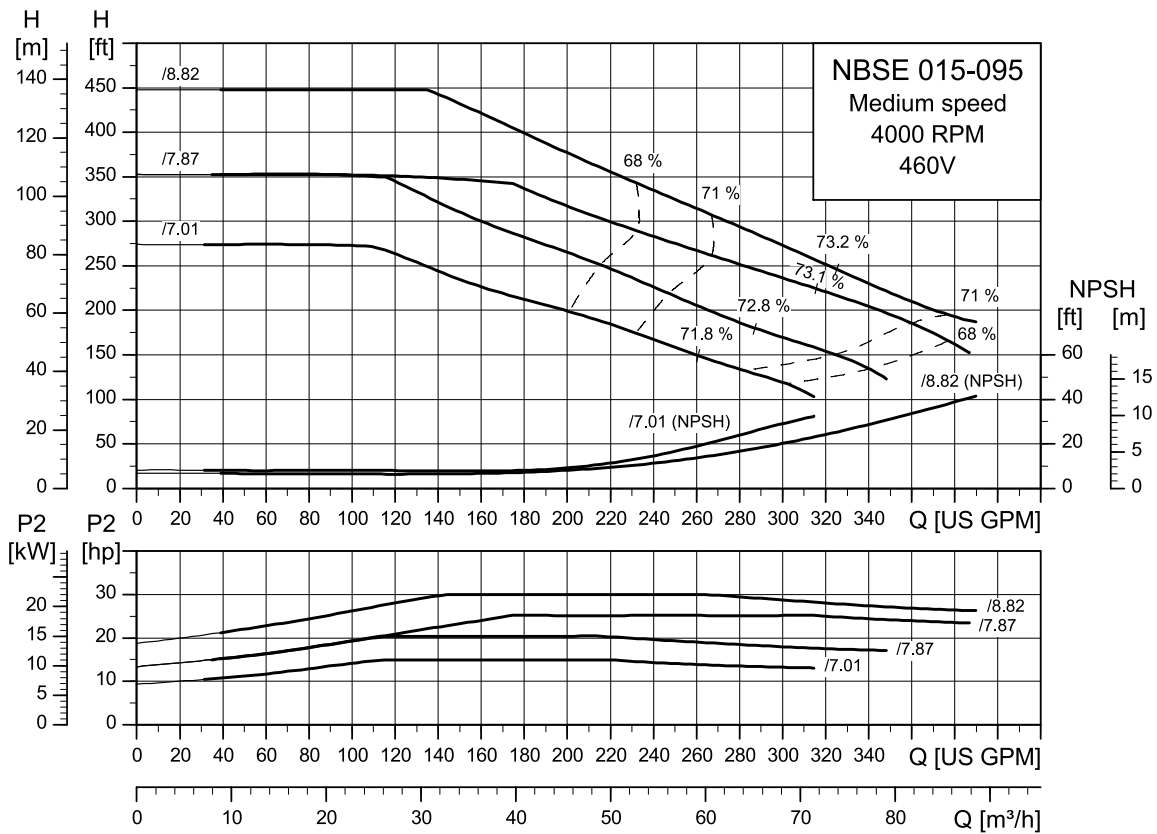

TM087599

**NBSE 020-095**

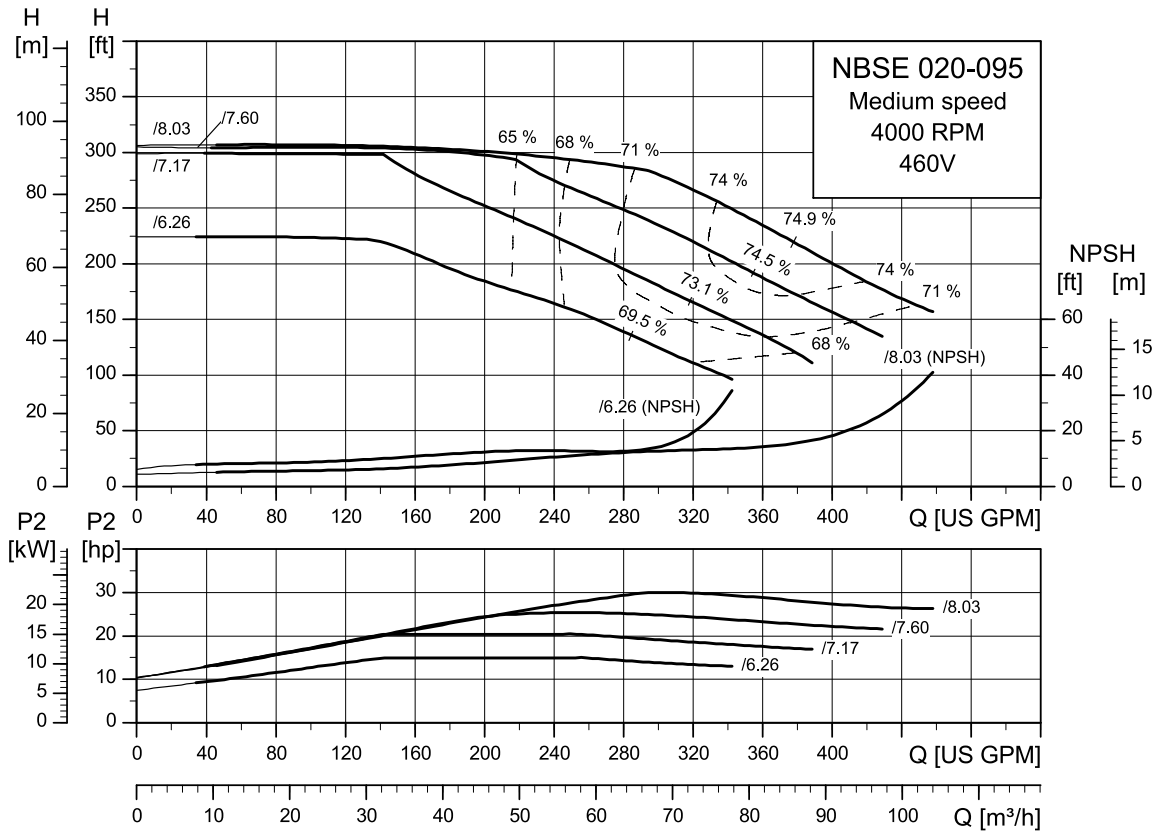

TM087600

**NBSE 025-070**

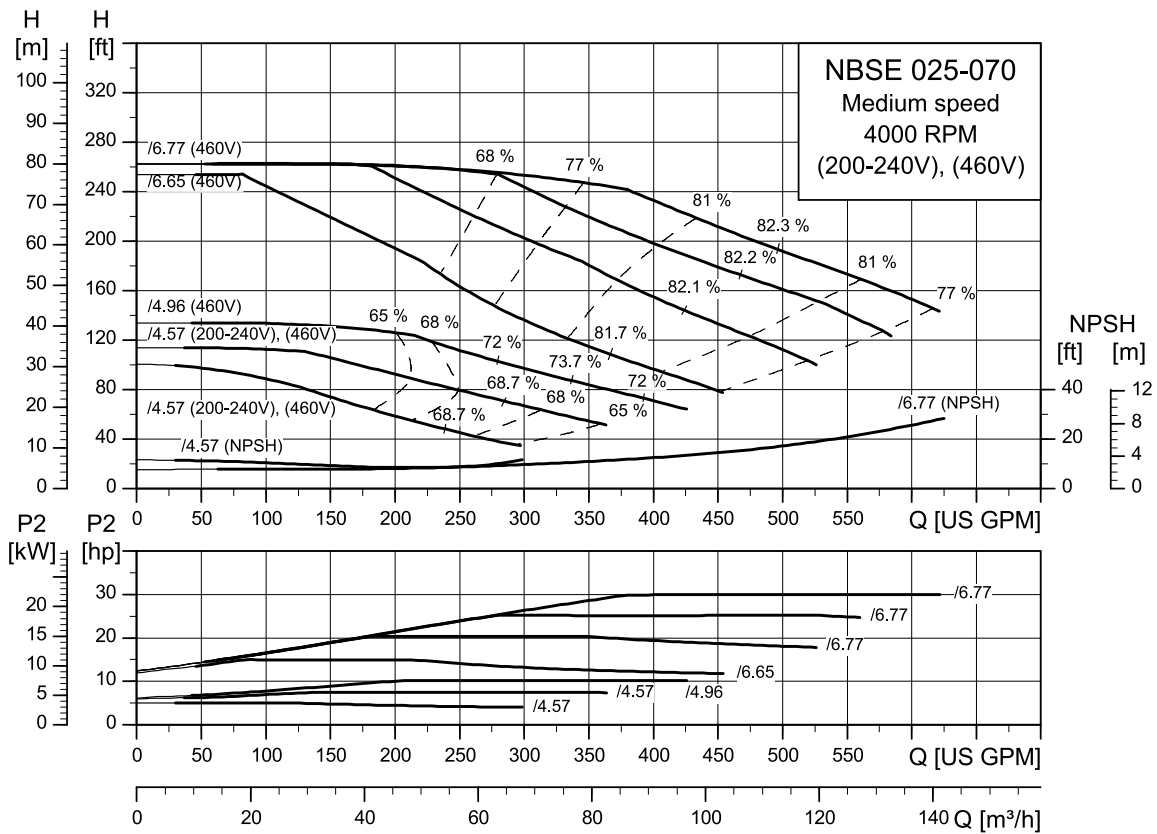

TM080528

**NBSE 025-095**

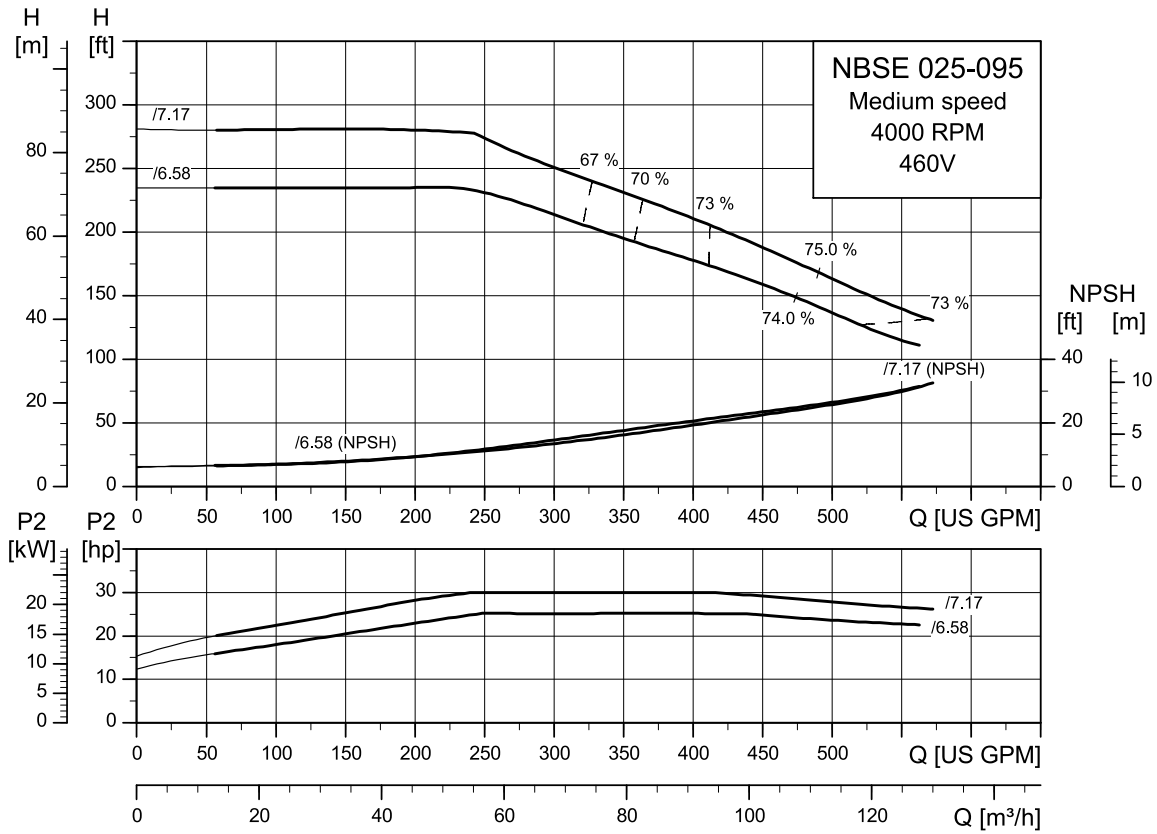

TM087601

**NBSE 030-070**

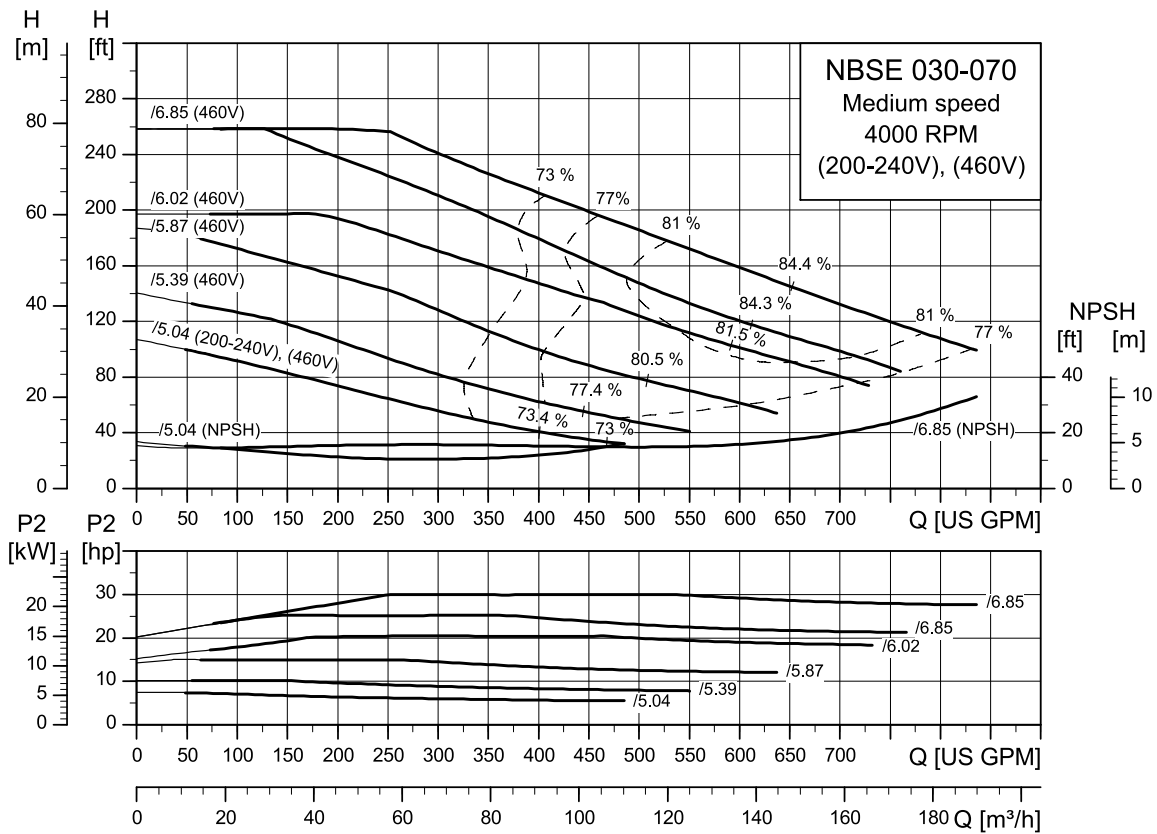

TM080529

**NBSE 040-070**

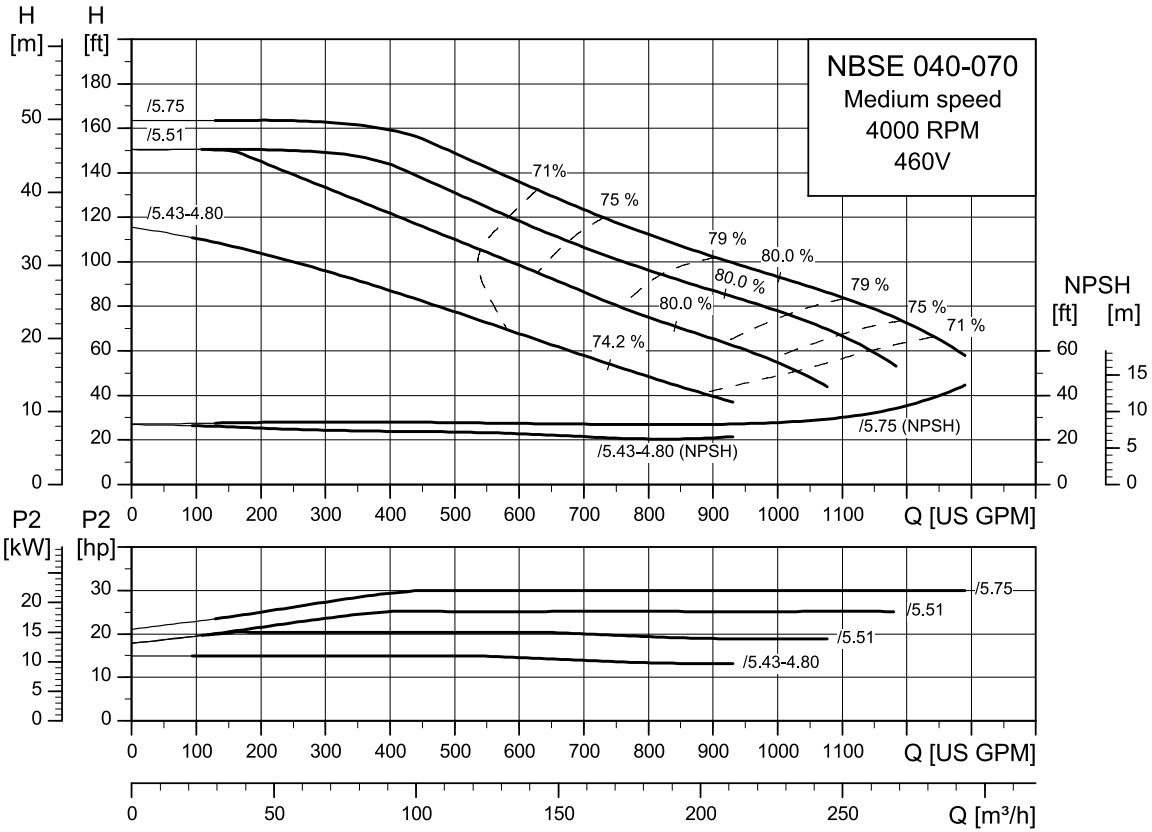

TM087596

**NBSE 050-070**

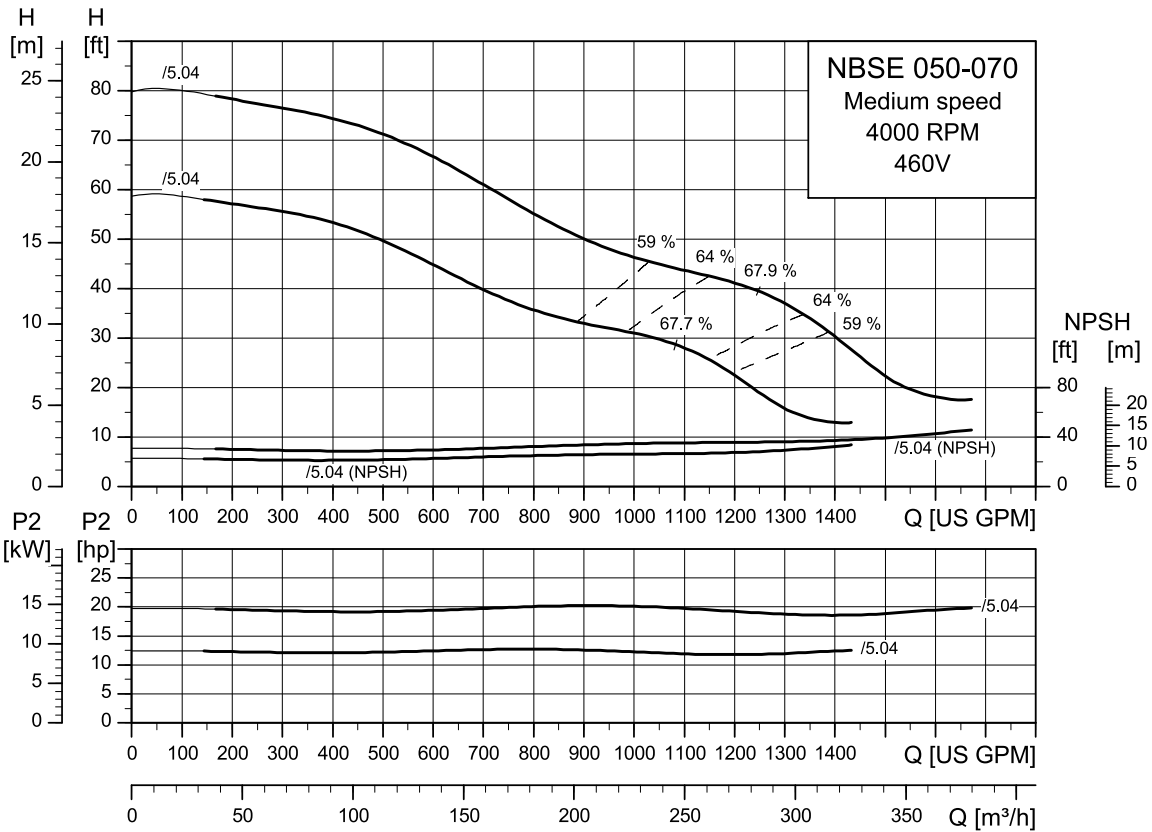

TM087597

### Low speed, 2000 - 2200 RPM

012-070

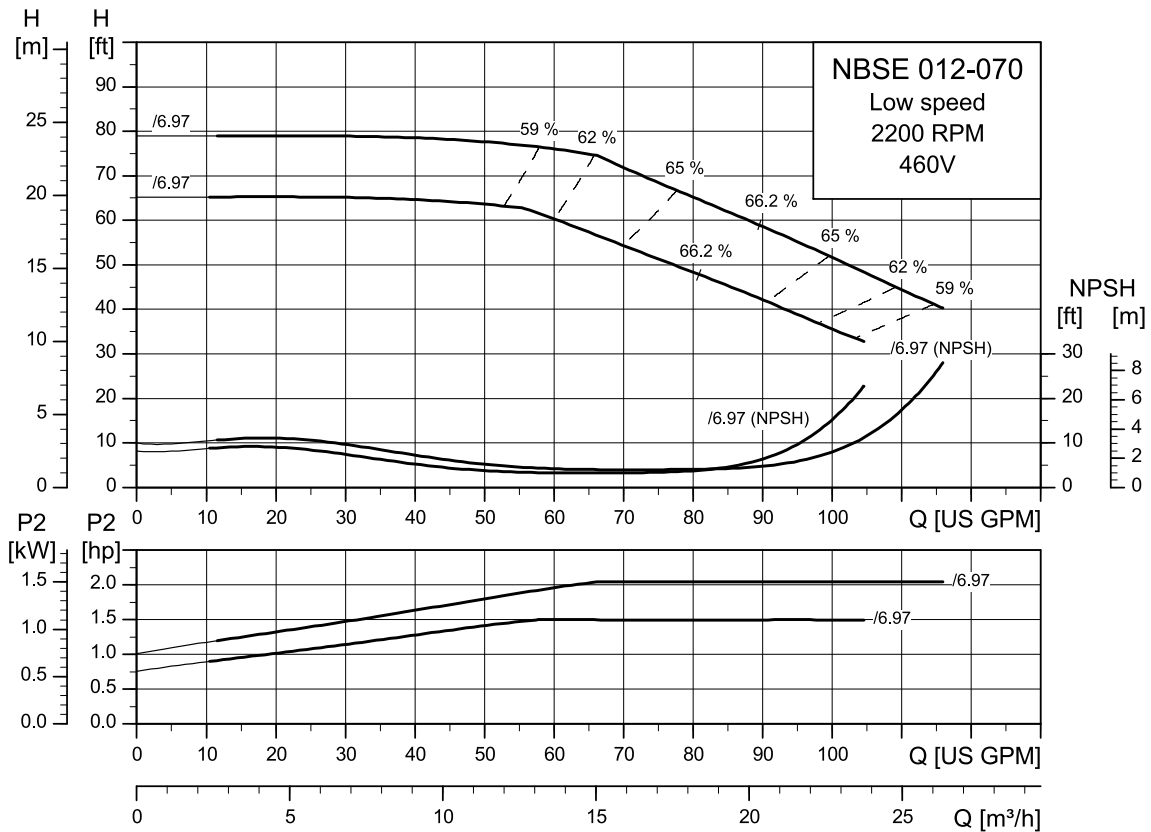

TM087608

015-070

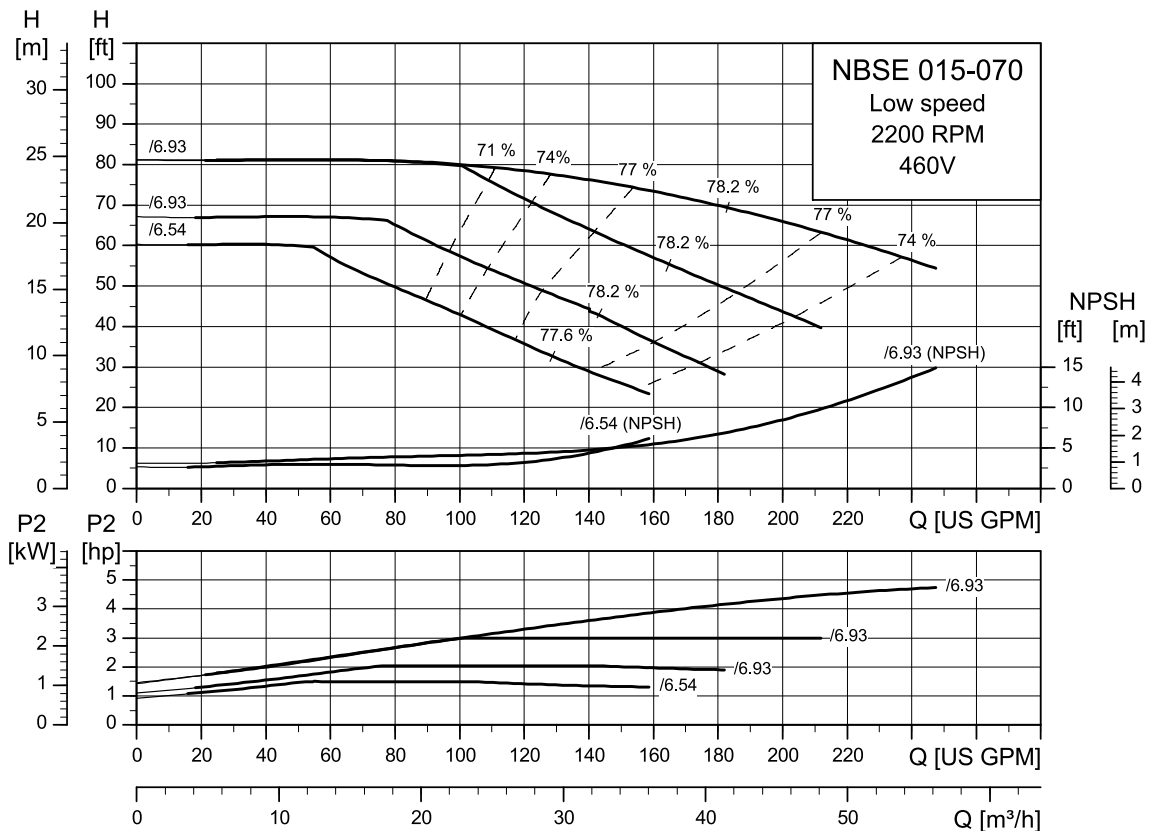

TM080530

015-090

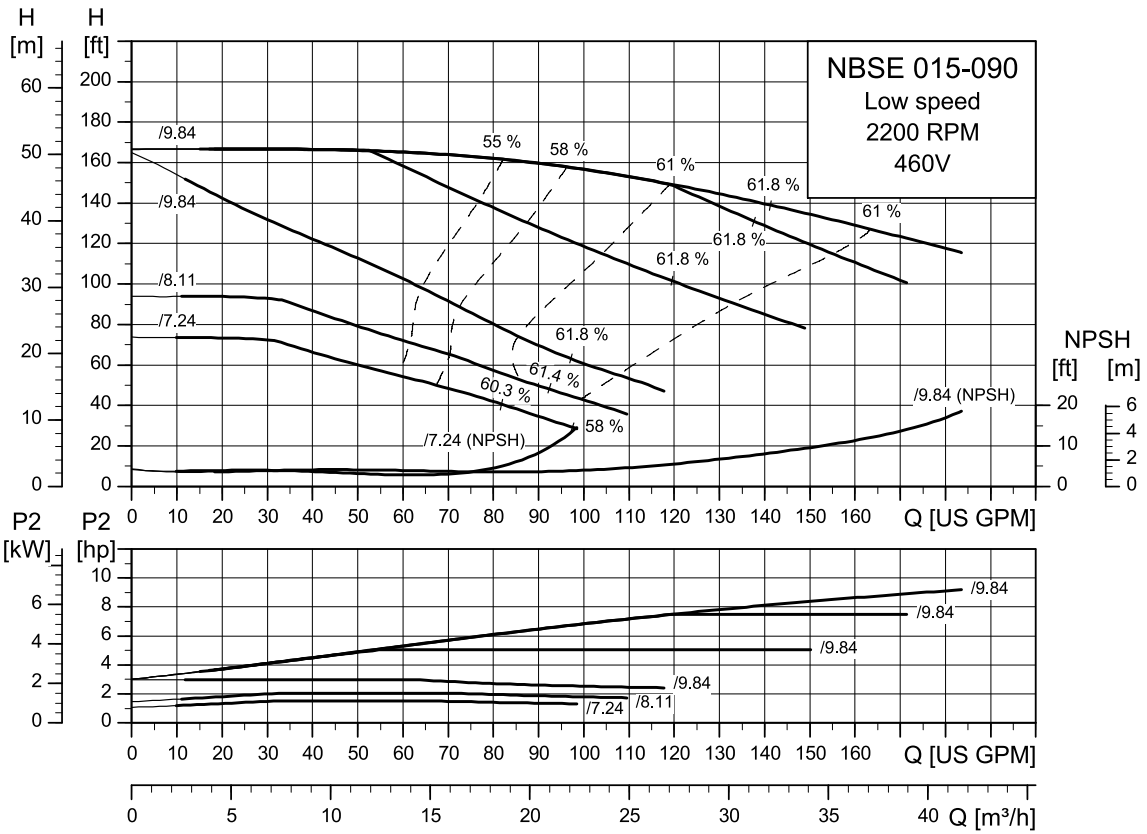

TM080531

015-095

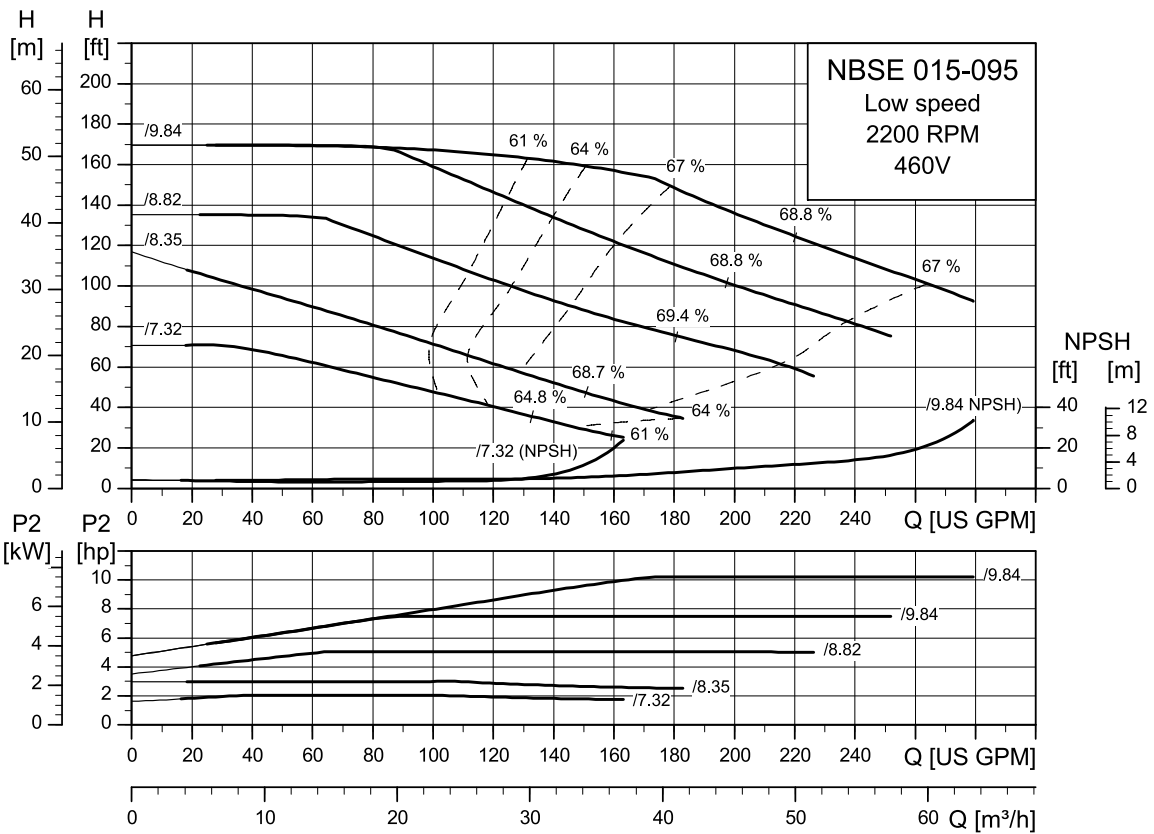

TM080532



020-095

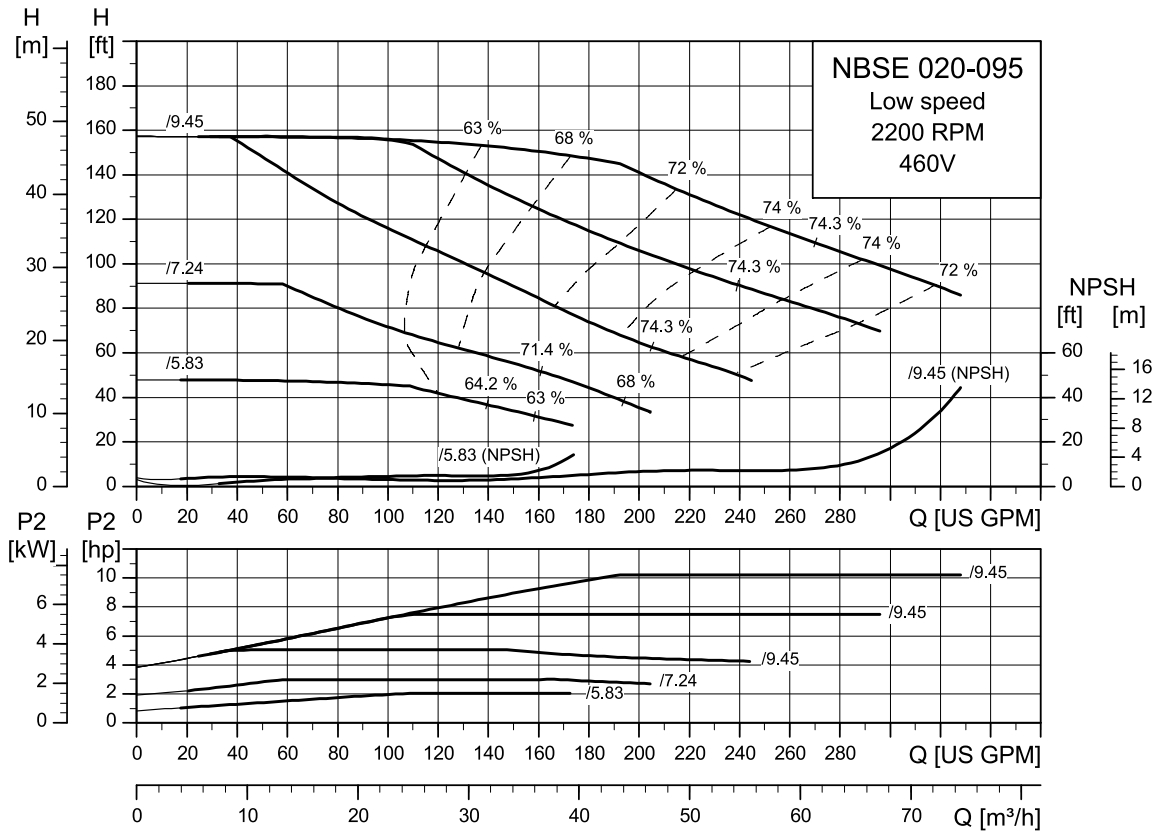

TM080533

020-110

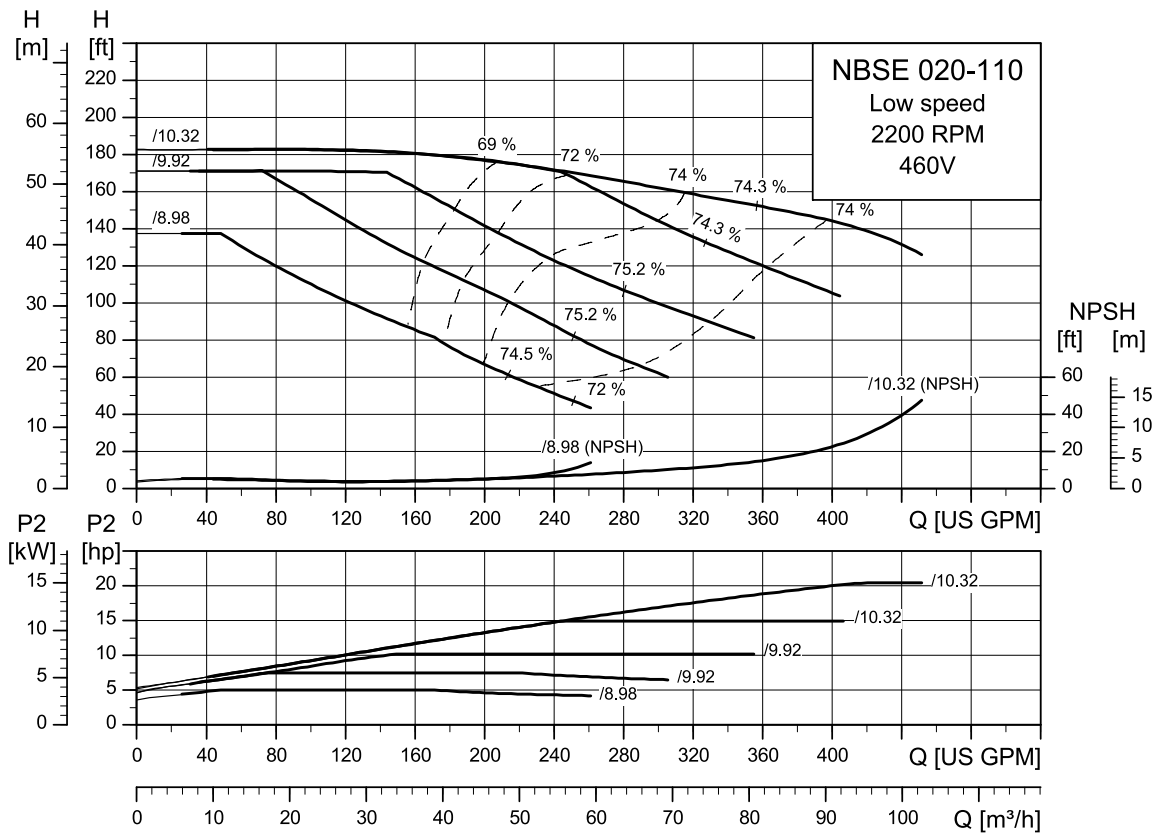

TM080534

020-135

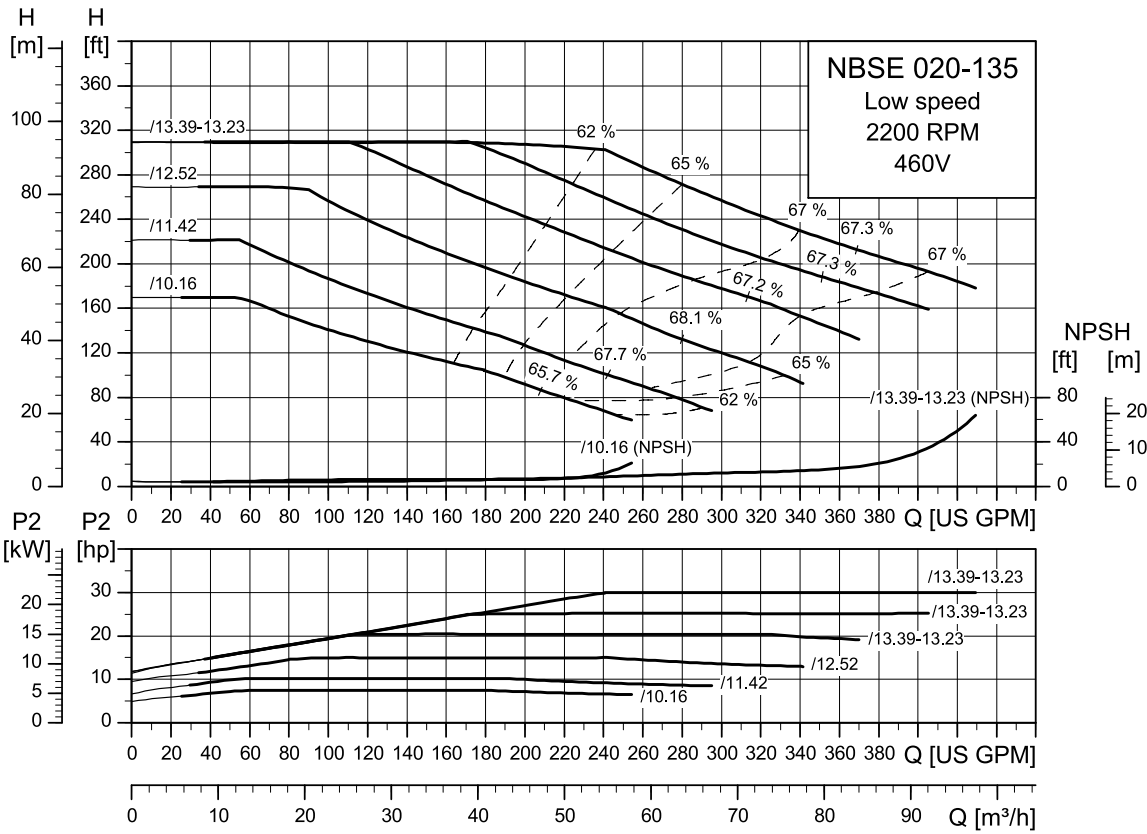

TM087612

025-070

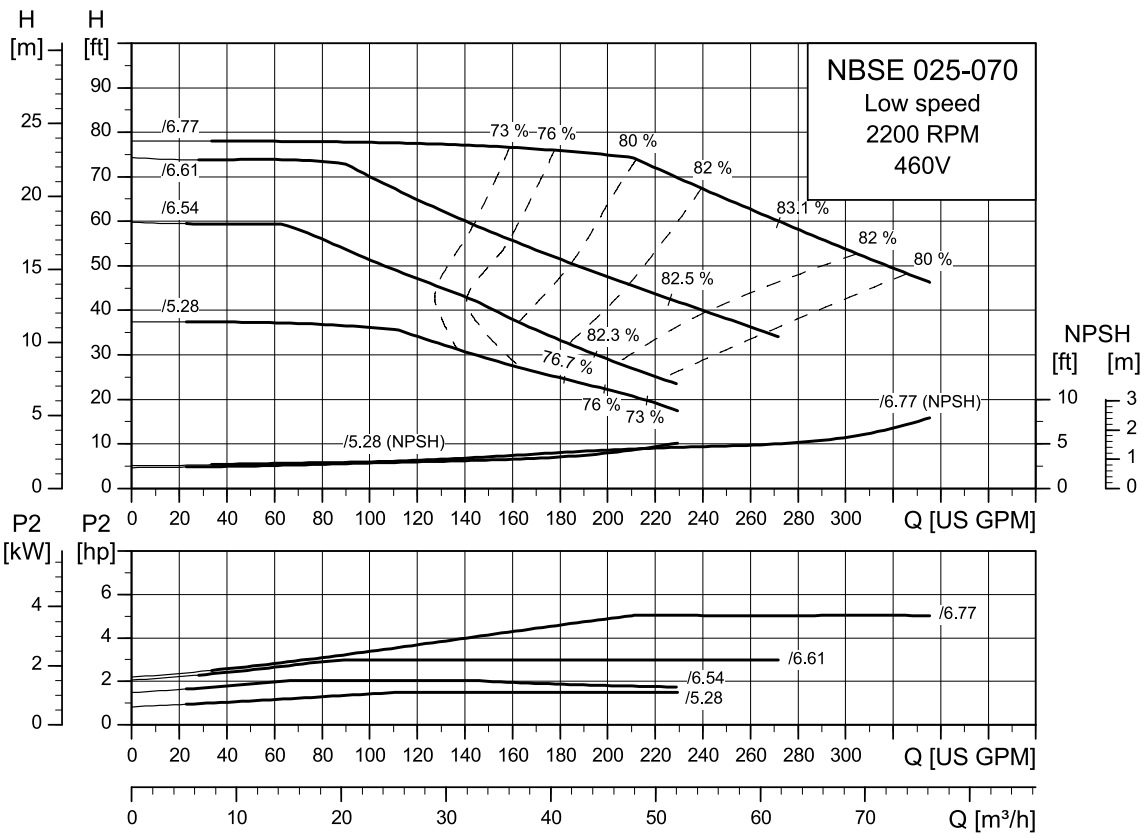

TM080535

025-095

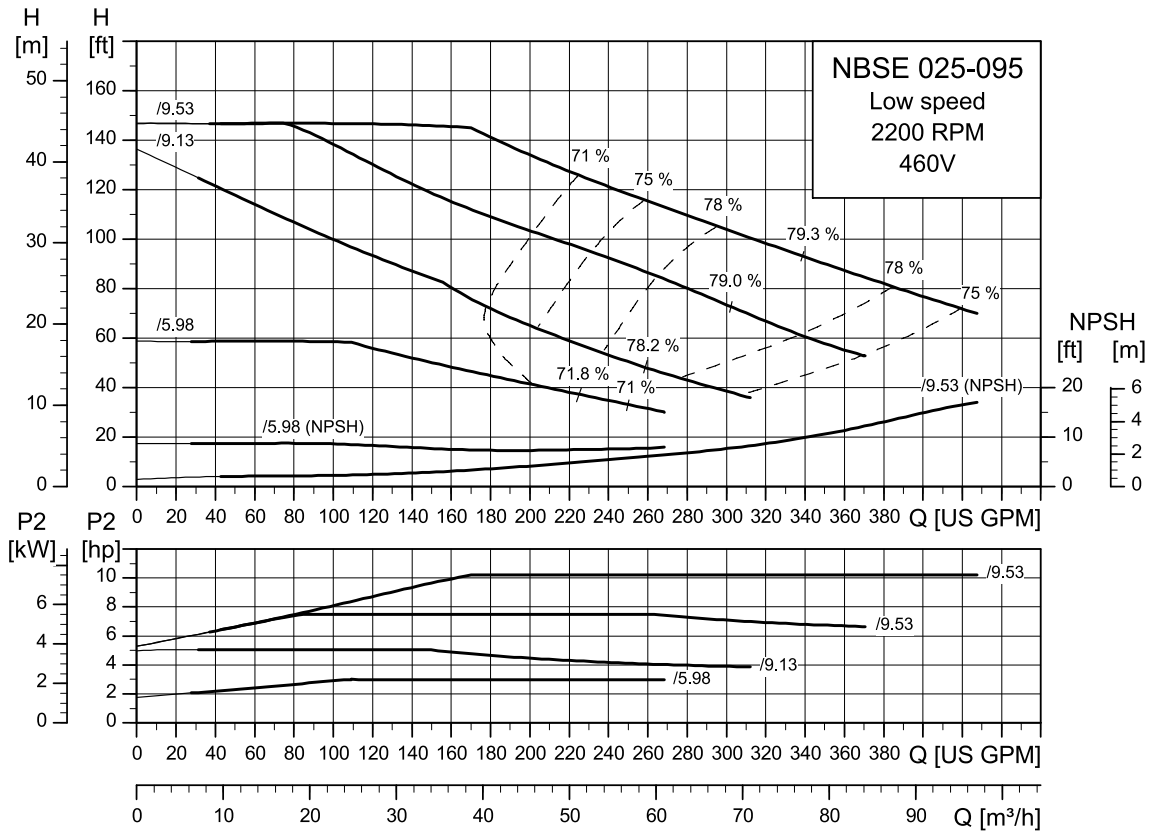

TM080536

025-110

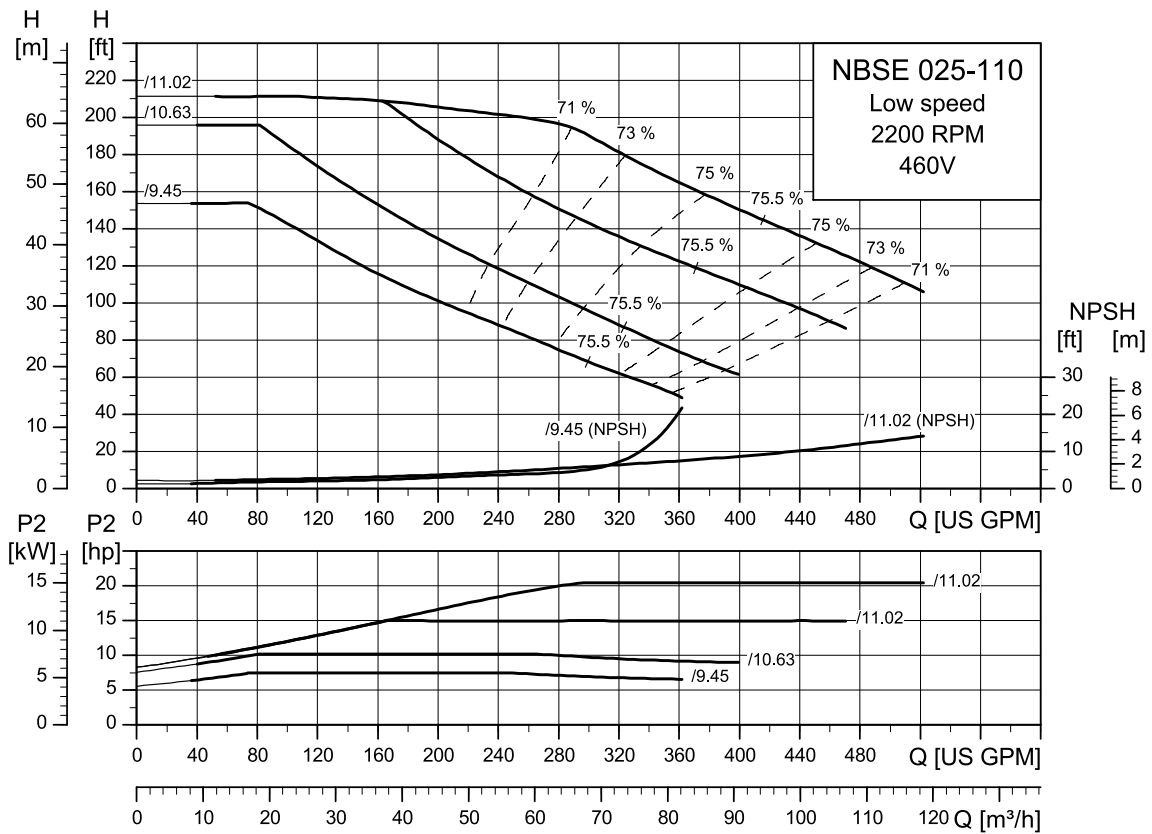

TM087609

030-070

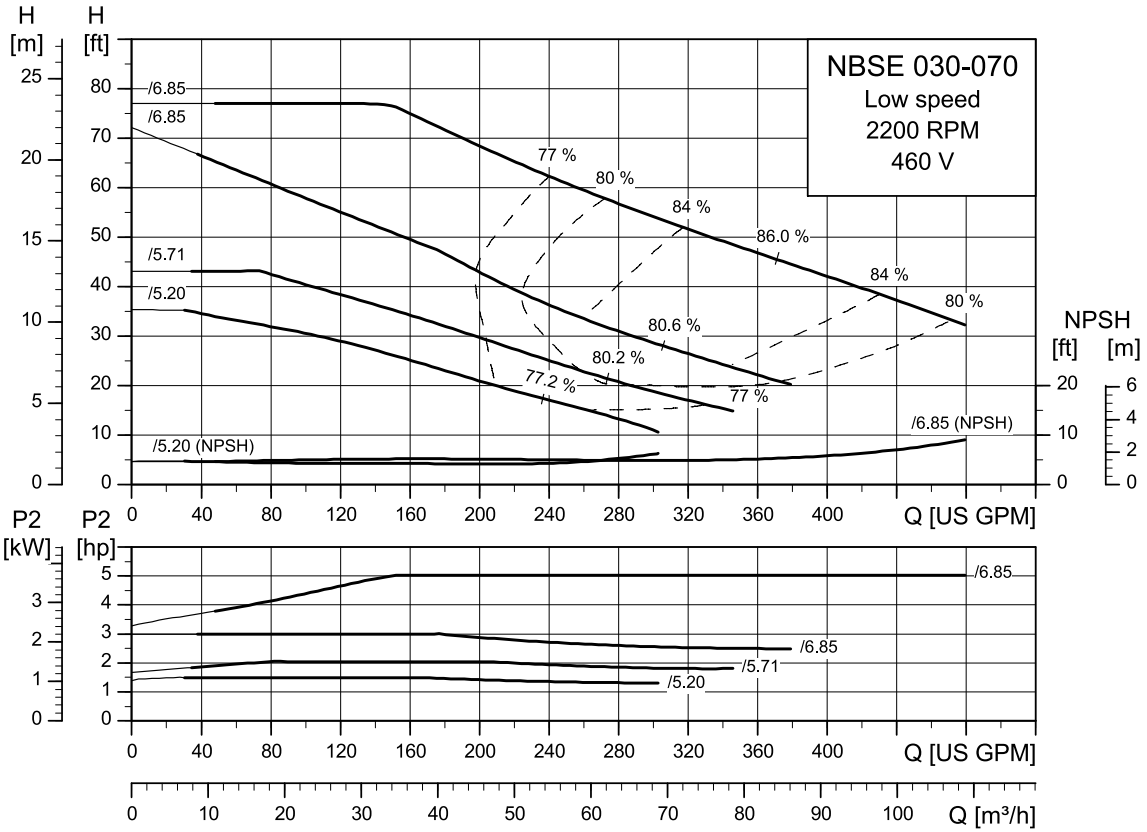

TM080537

030-095

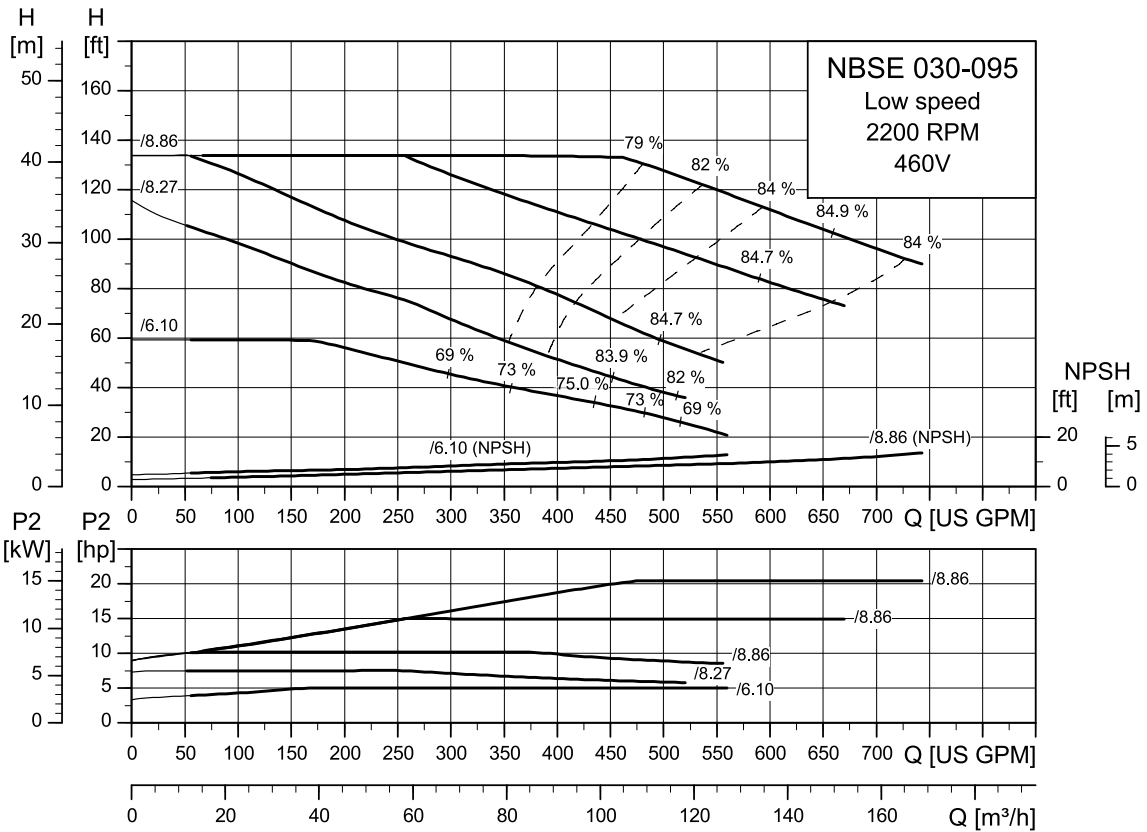

TM080538

030-110

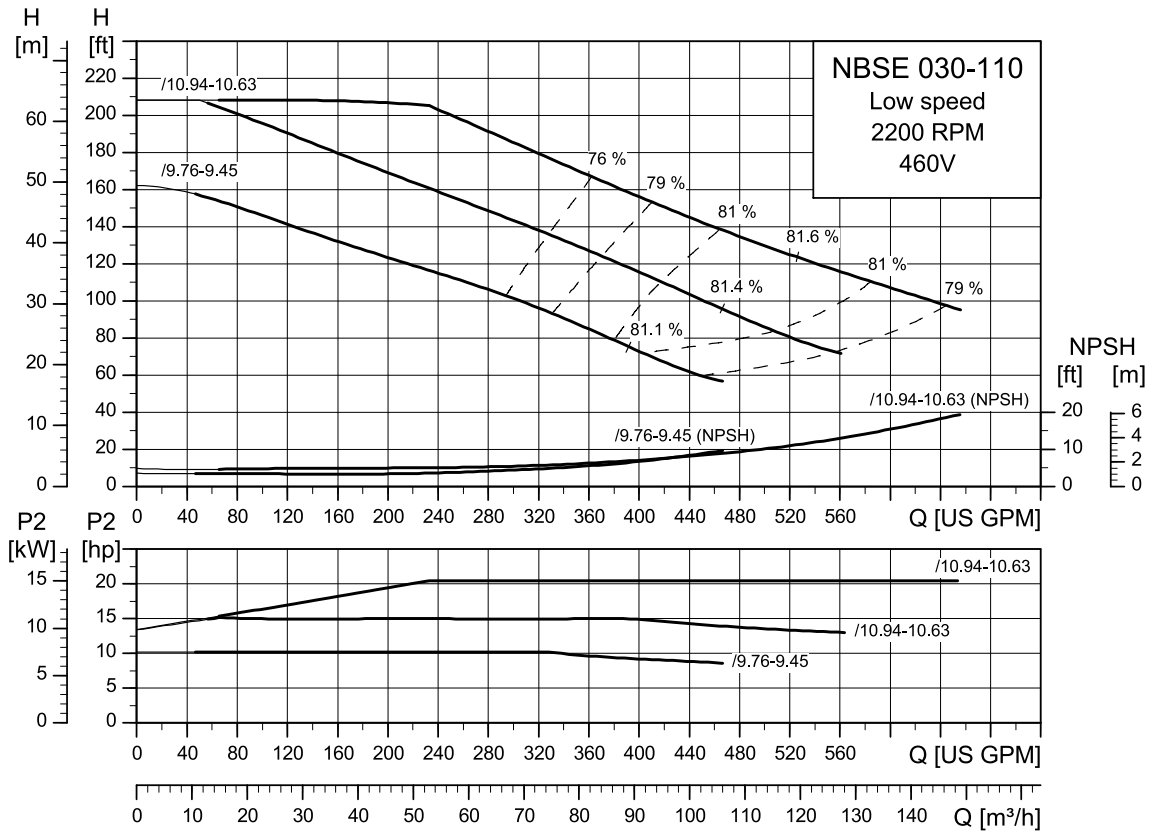

TM087610

030-135

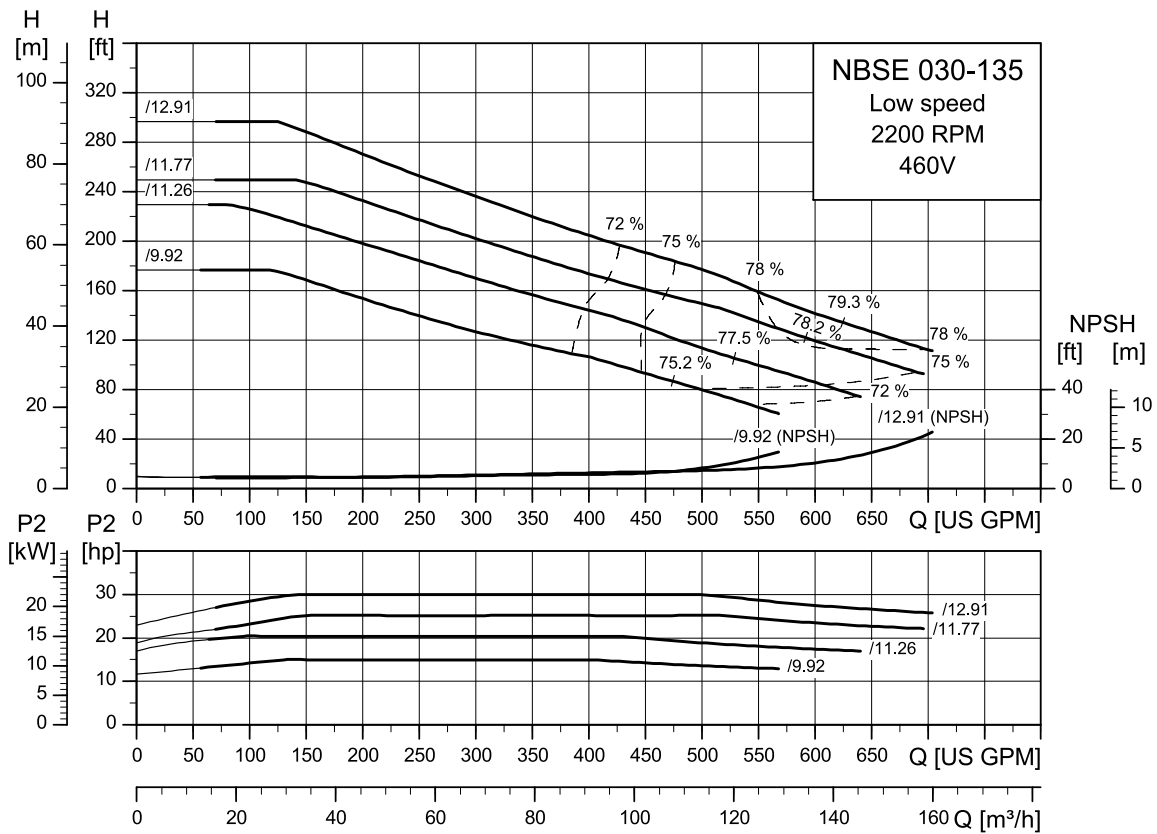

TM087613

040-070

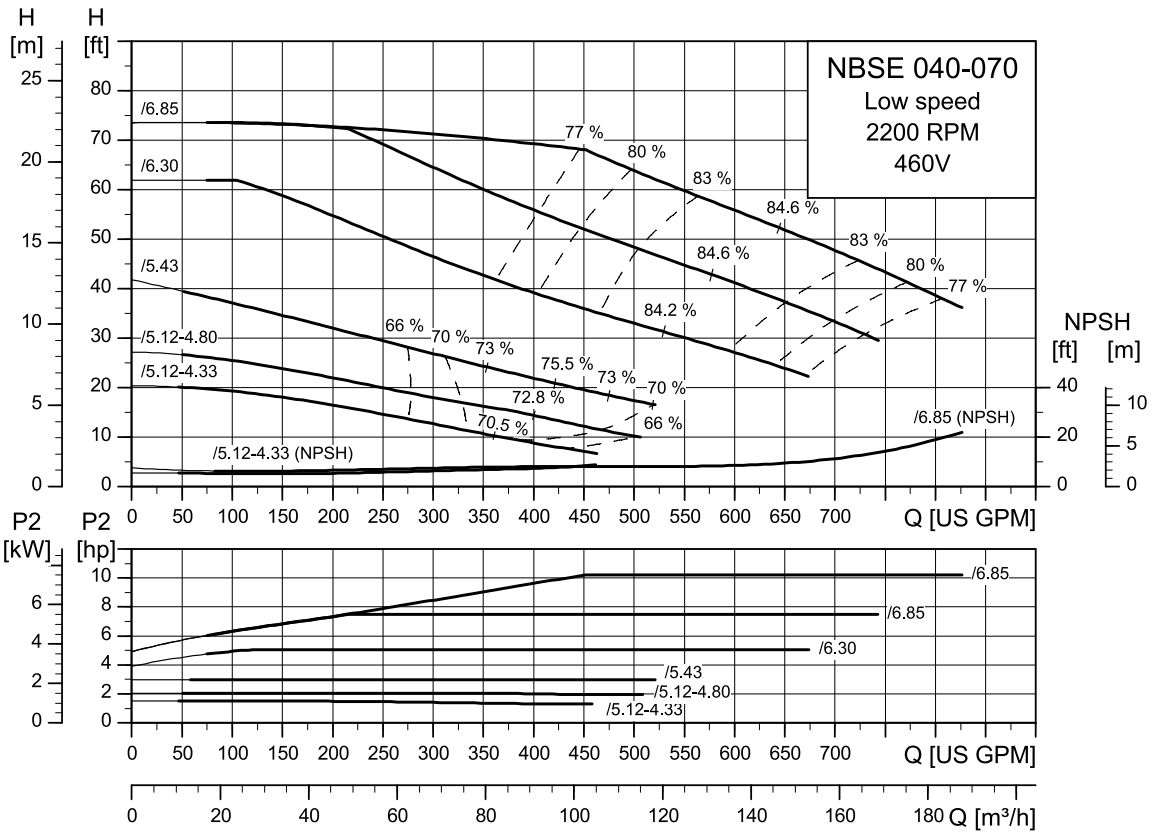

TM080539

040-095

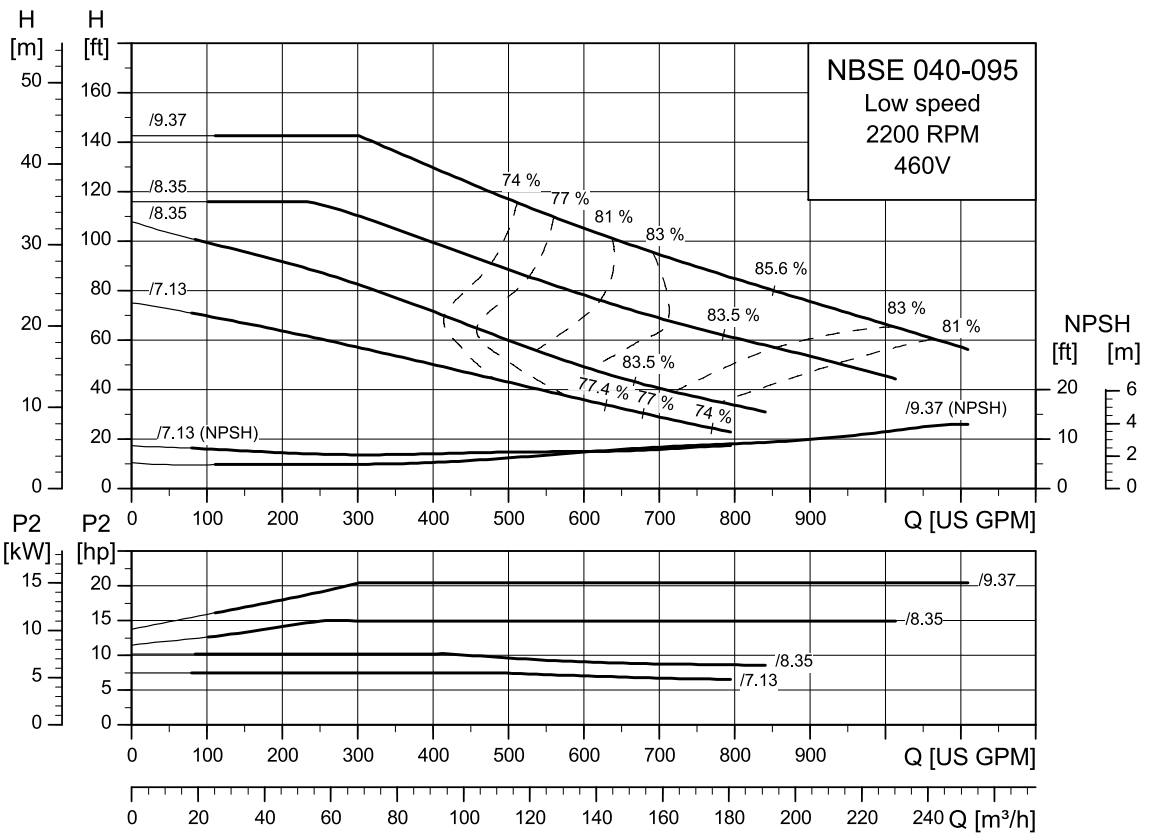

TM087614

040-110

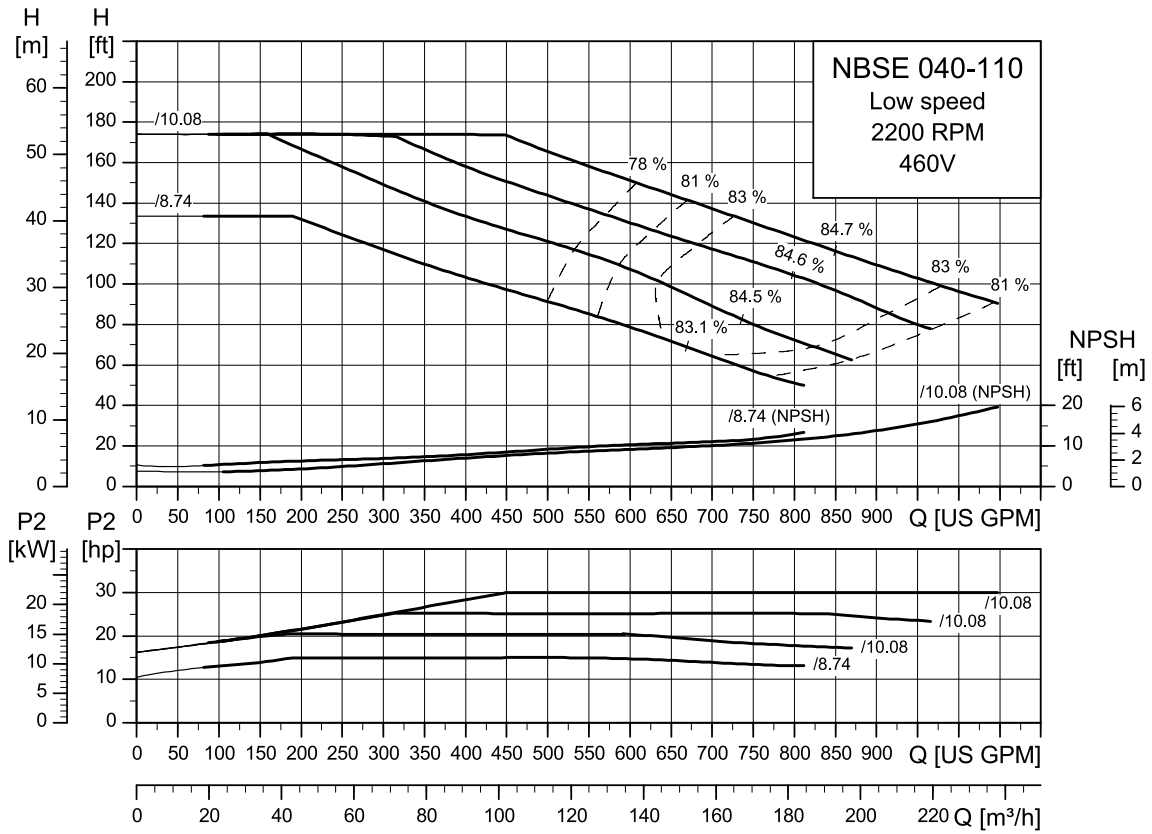

TM087611

040-135

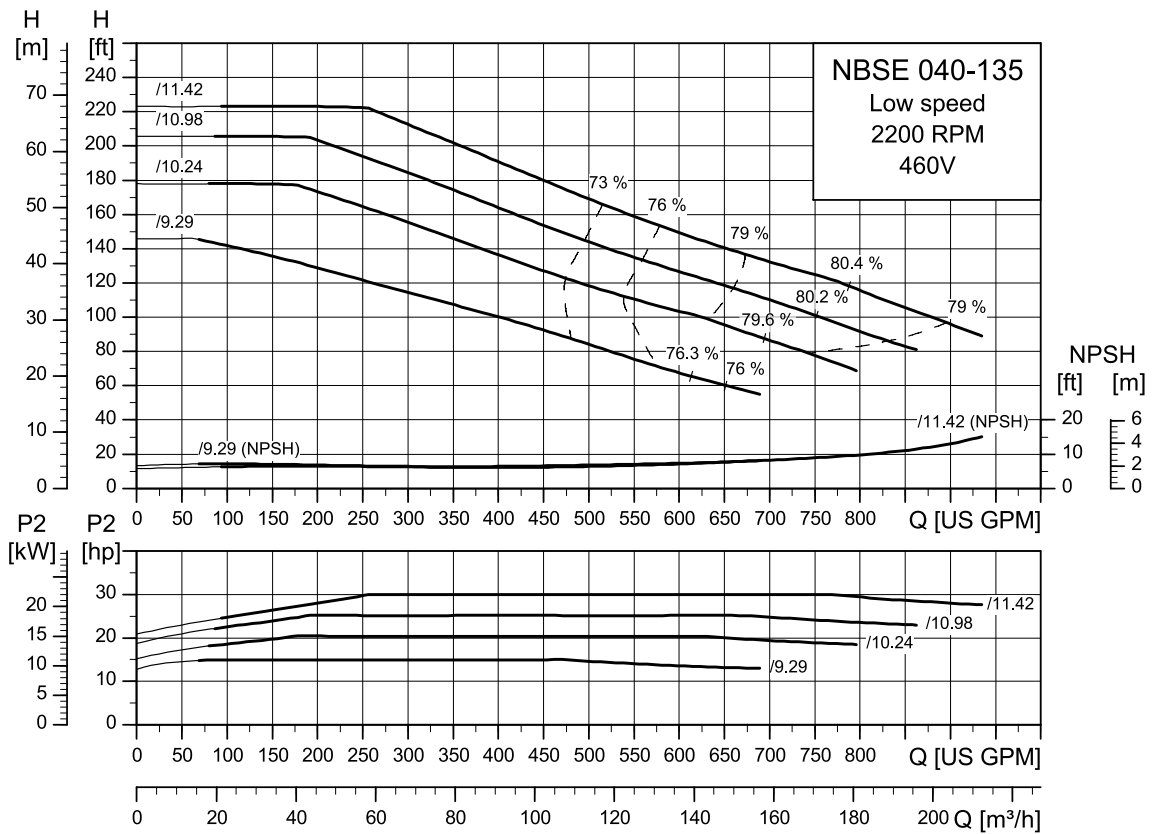

TM087615

050-070

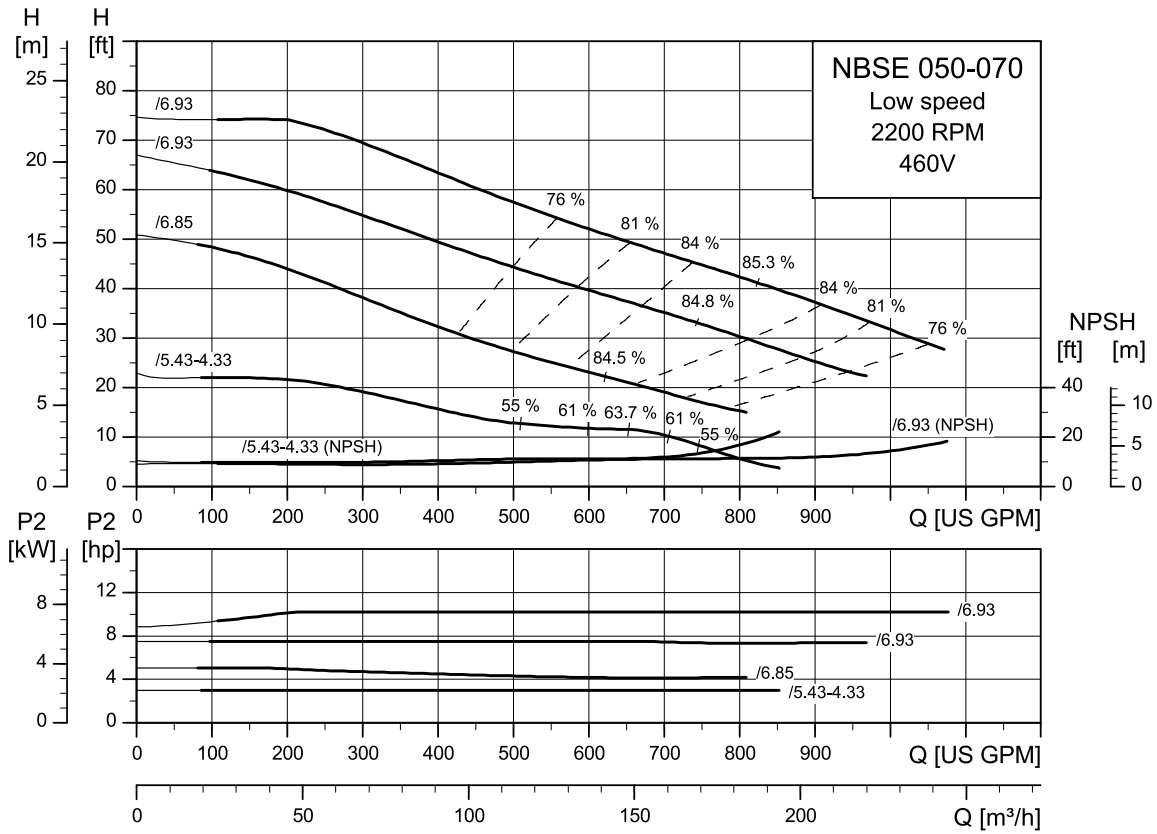

TM080540

050-095

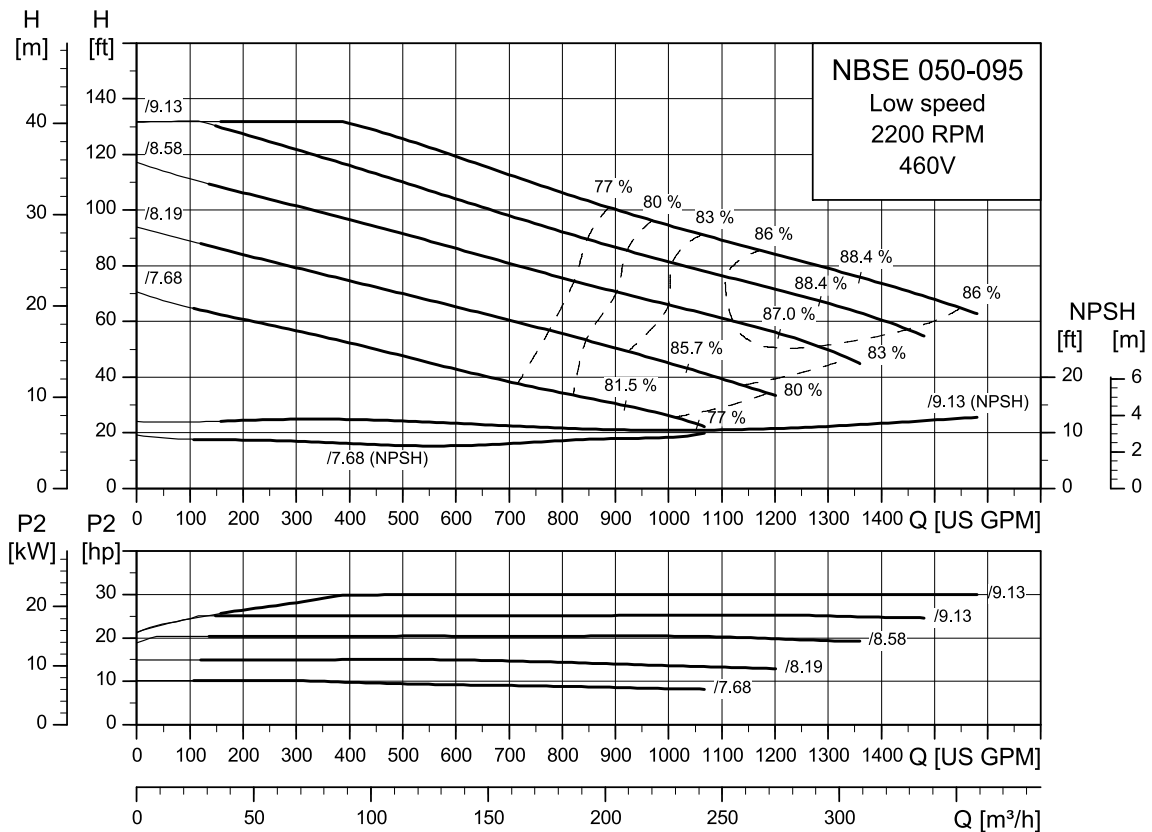

TM080541



050-110

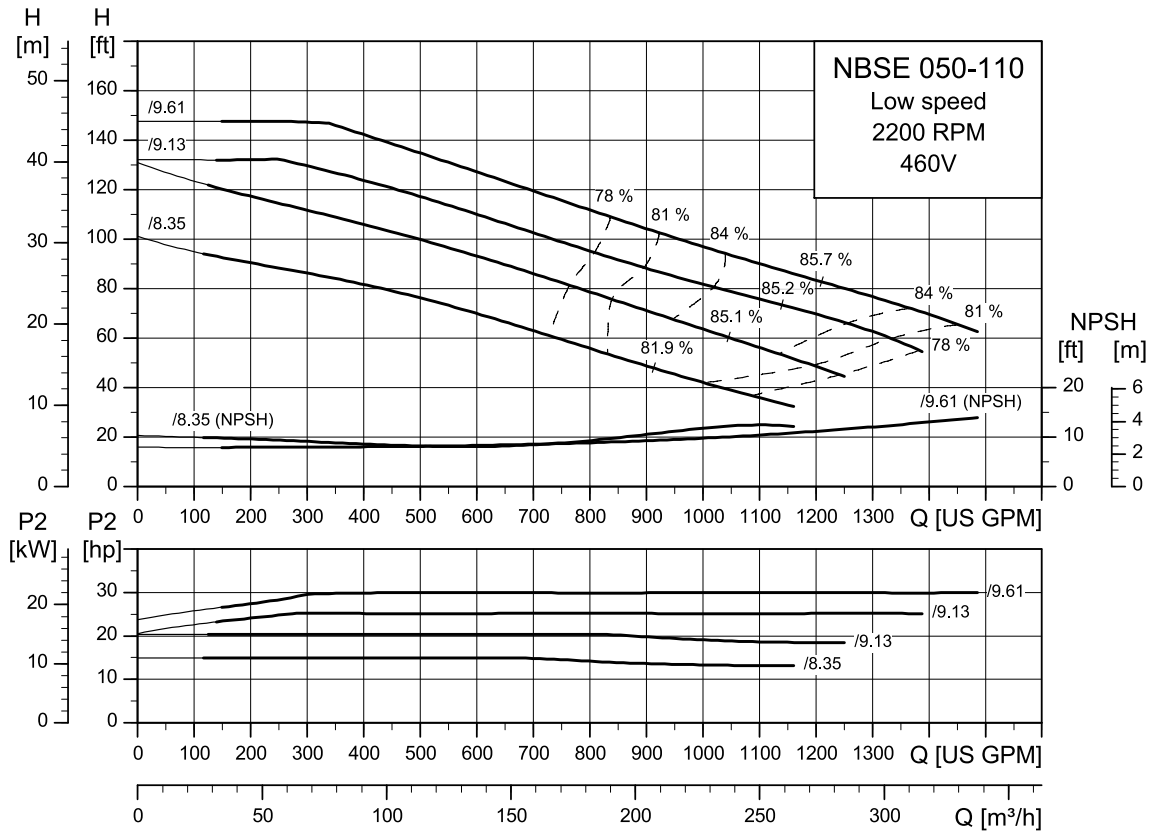

TM087616

060-095

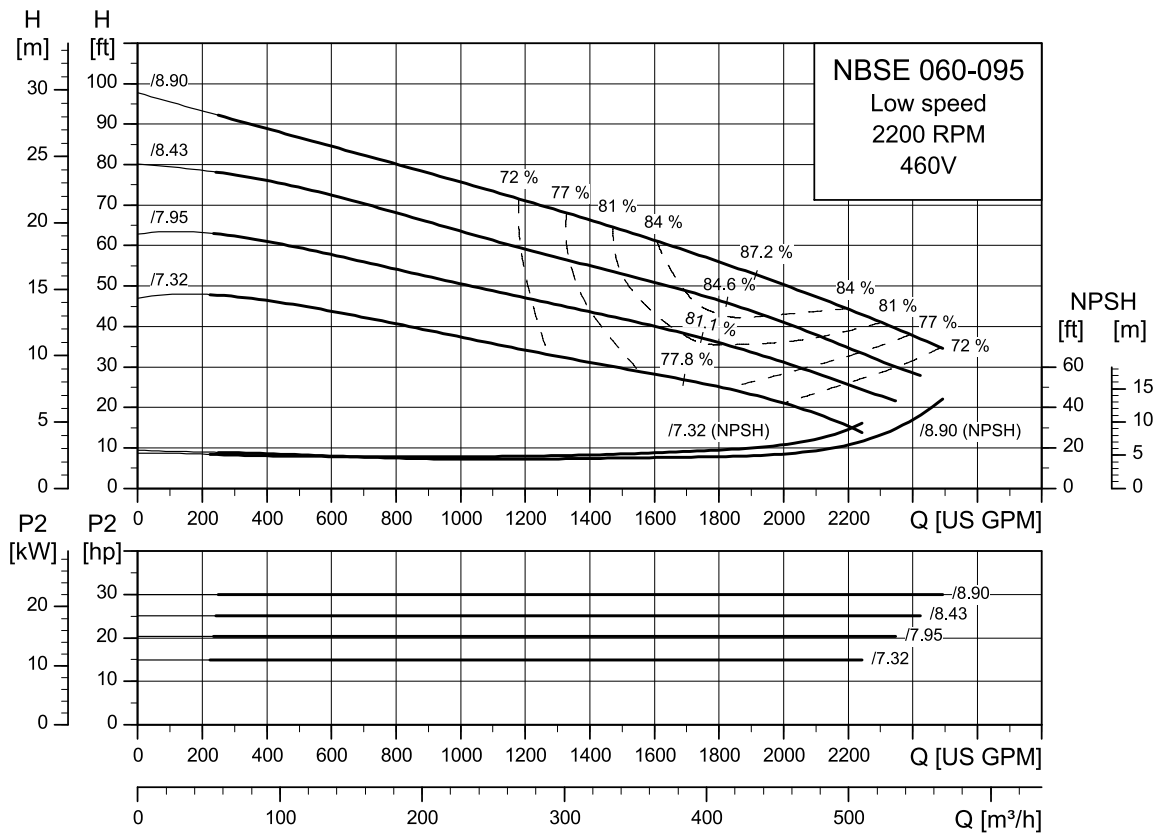

TM087617

060-110

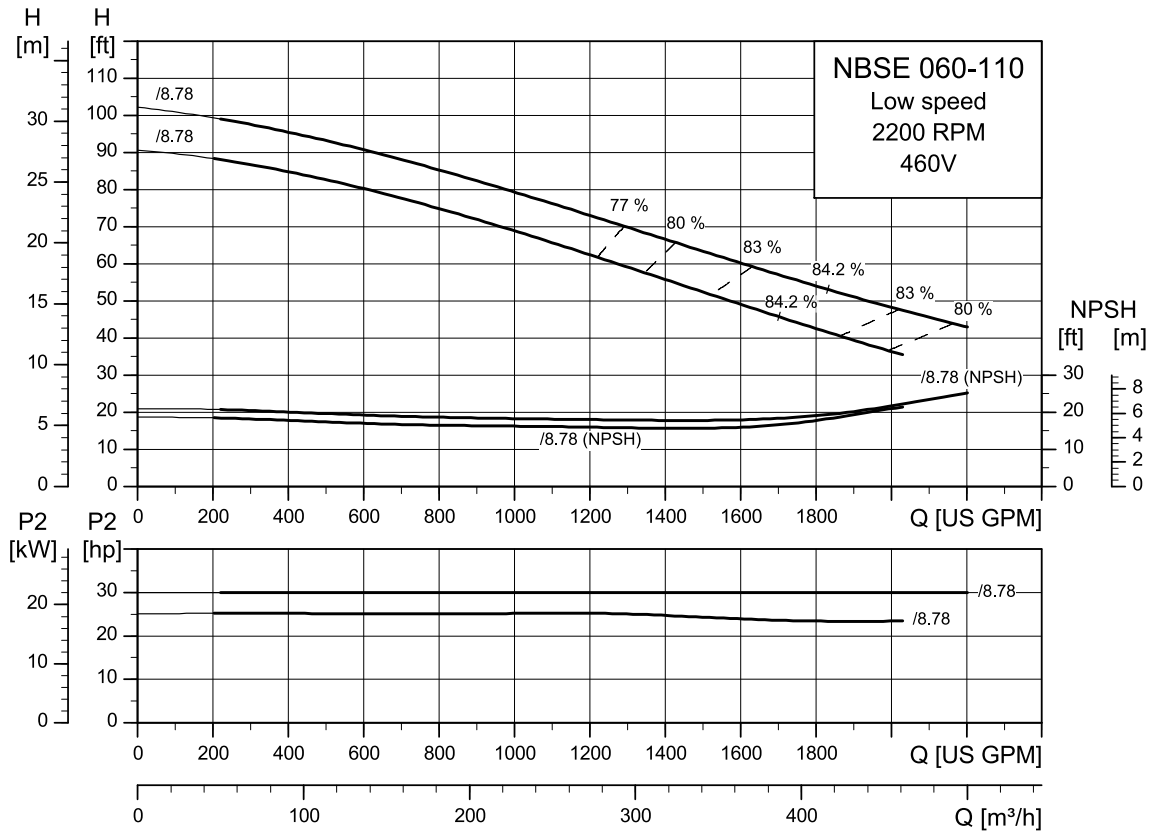

TM087618

2-pole

NBS 012-070

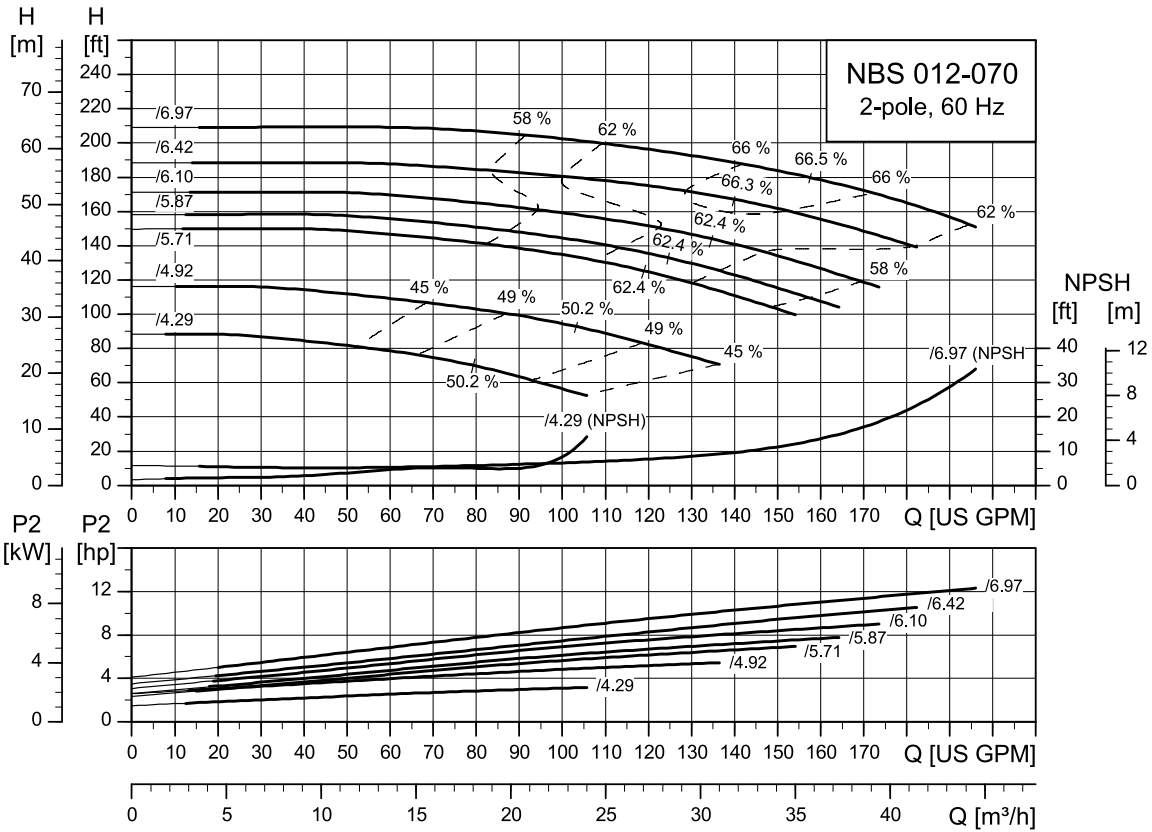

TM077805

NBS 015-070

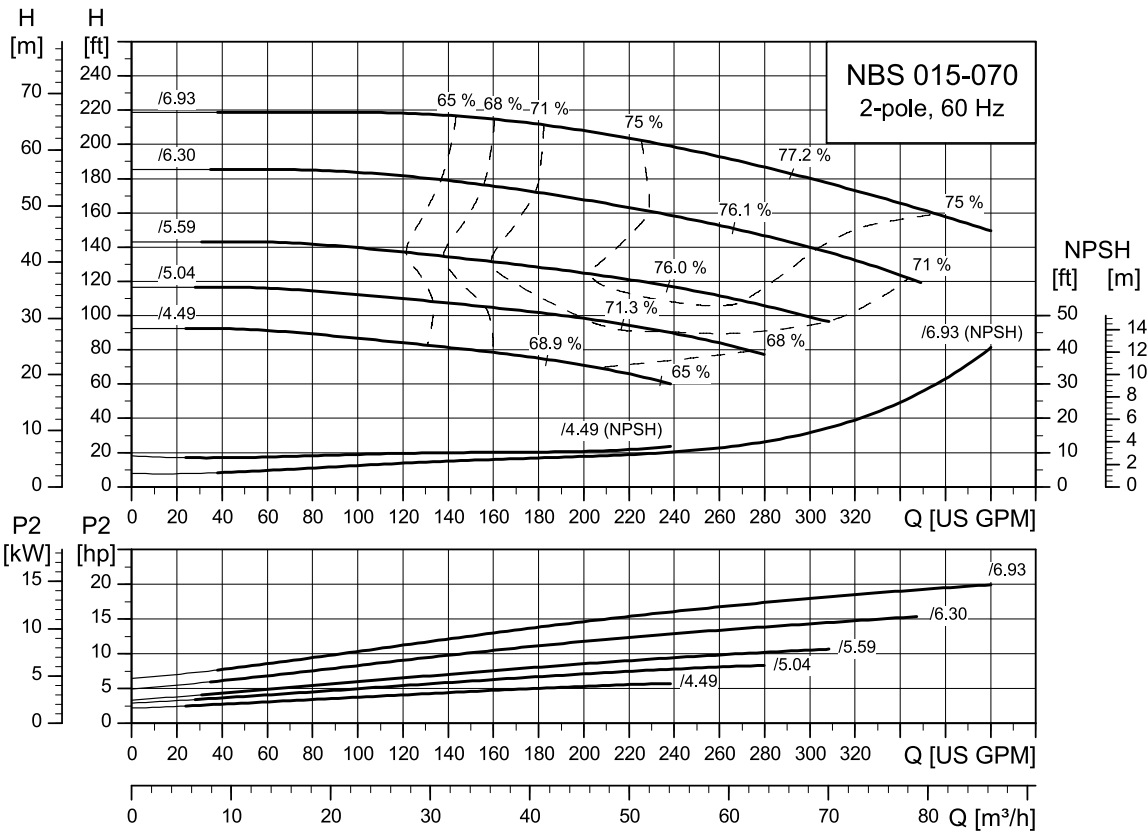

TM077513

**NBS 015-090**

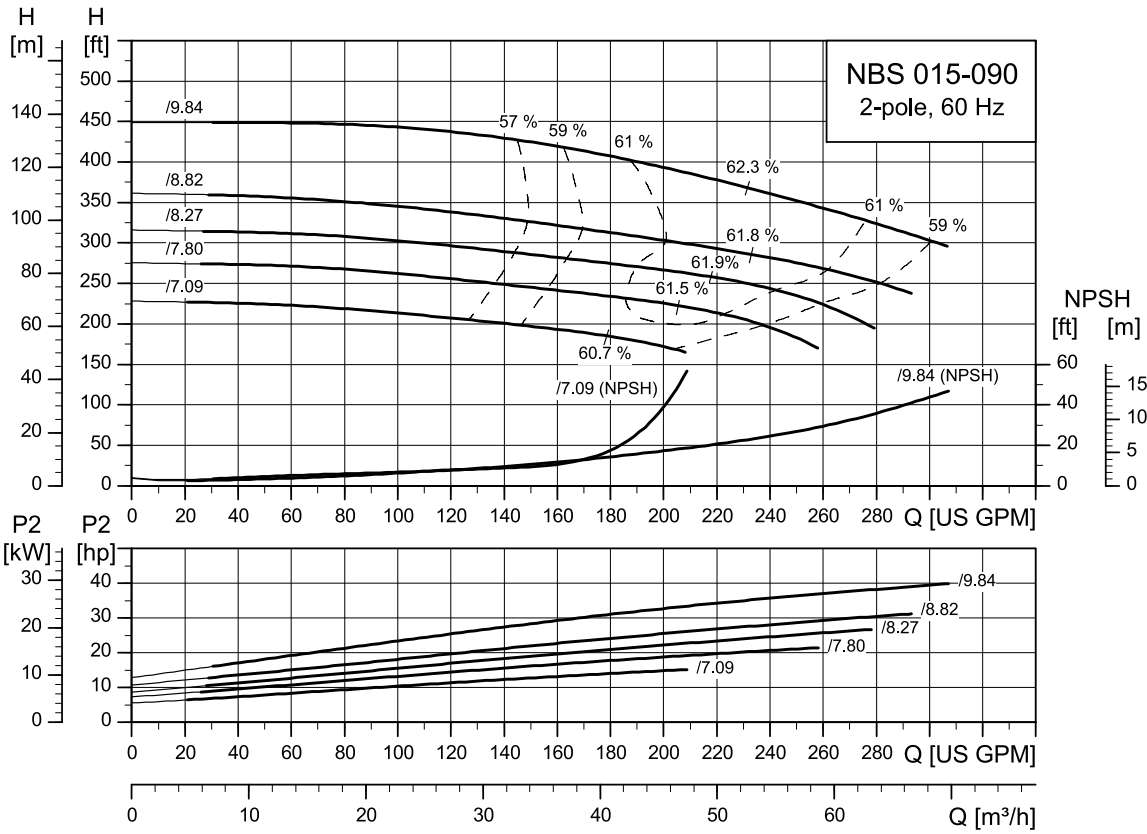

TM077807

**NBS 015-095**

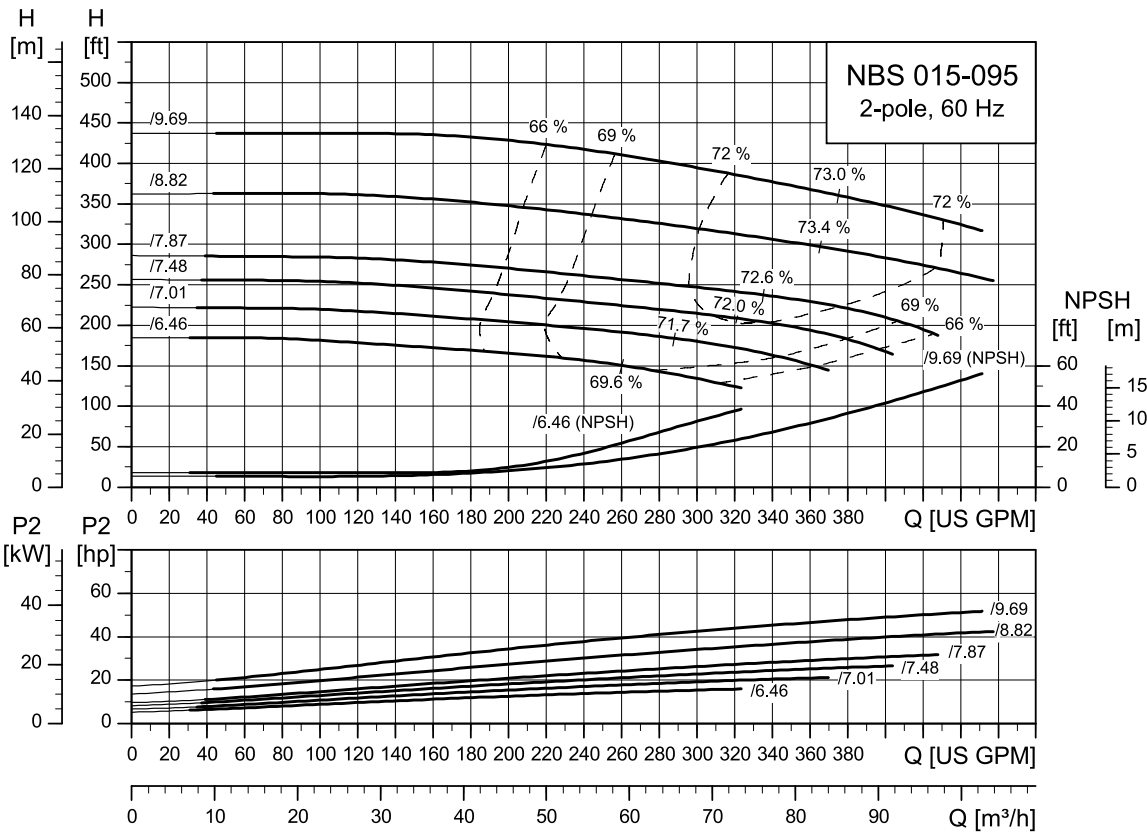

TM077809

**NBS 020-095**

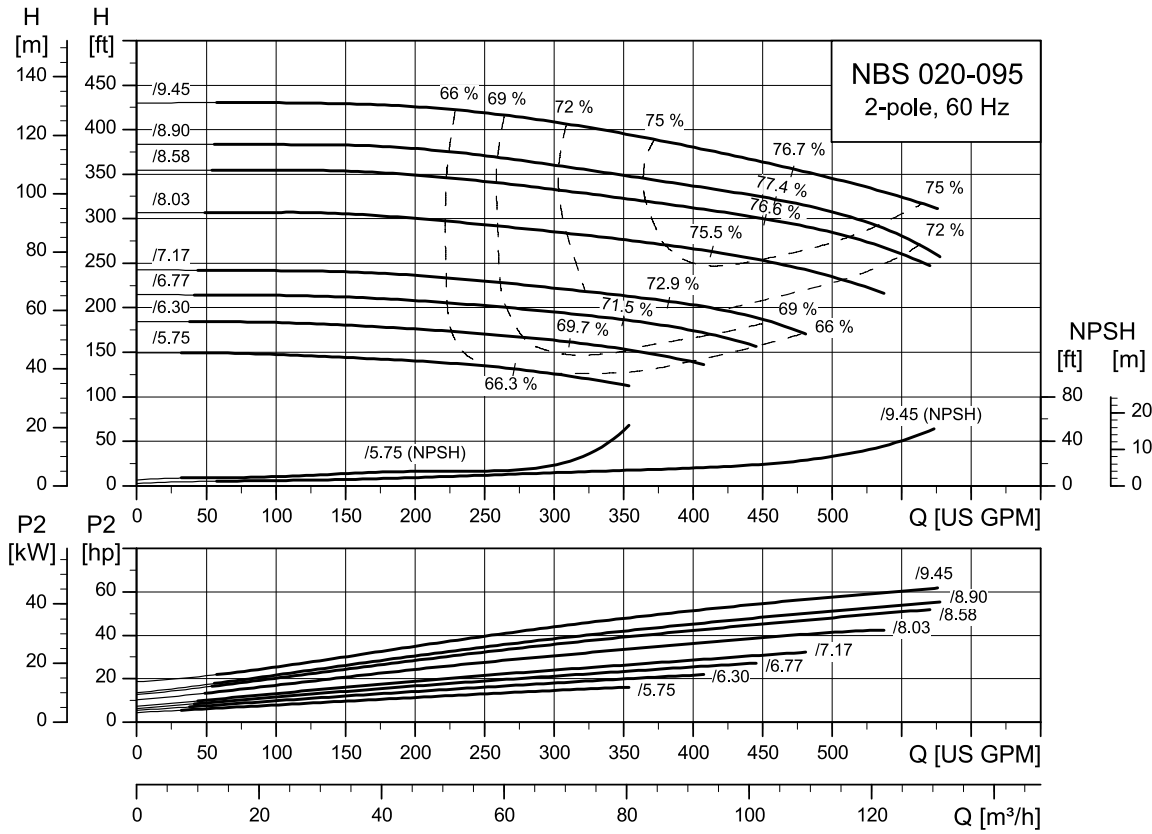

TM077515

**NBS 025-070**

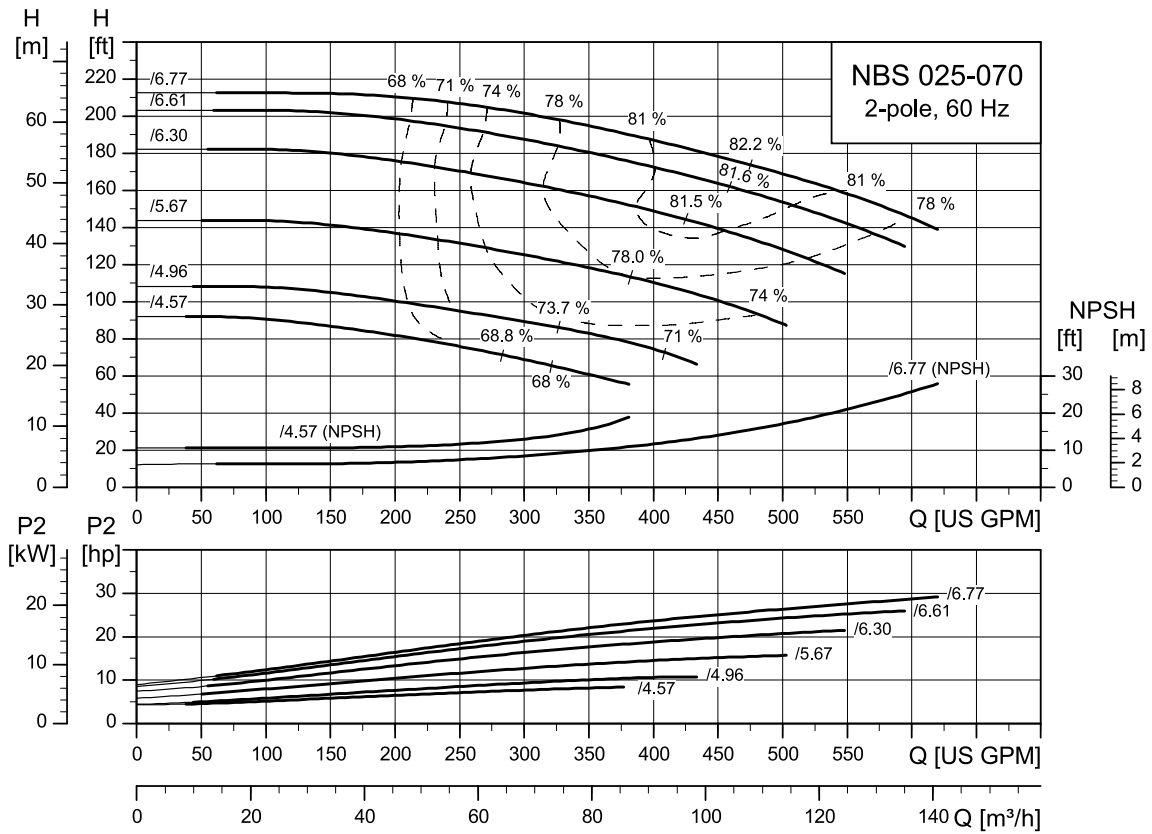

TM077811

**NBS 025-095**

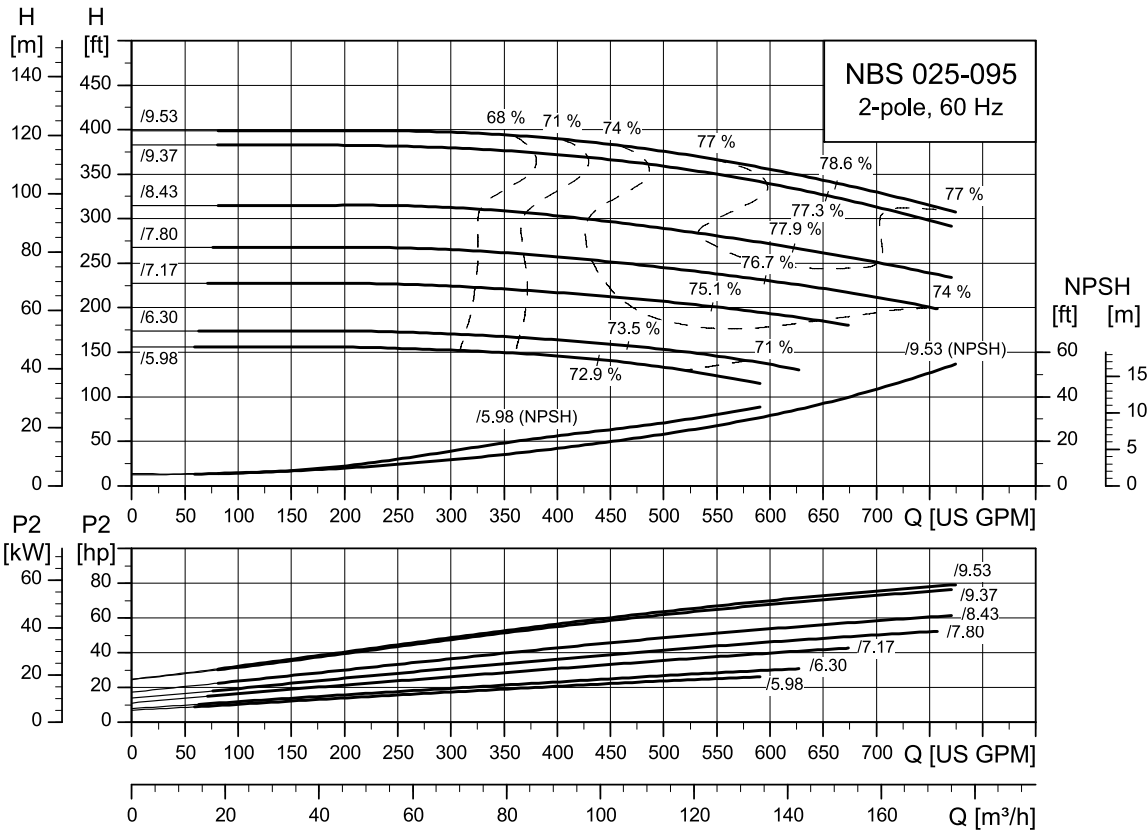

TM077303

**NBS 030-070**

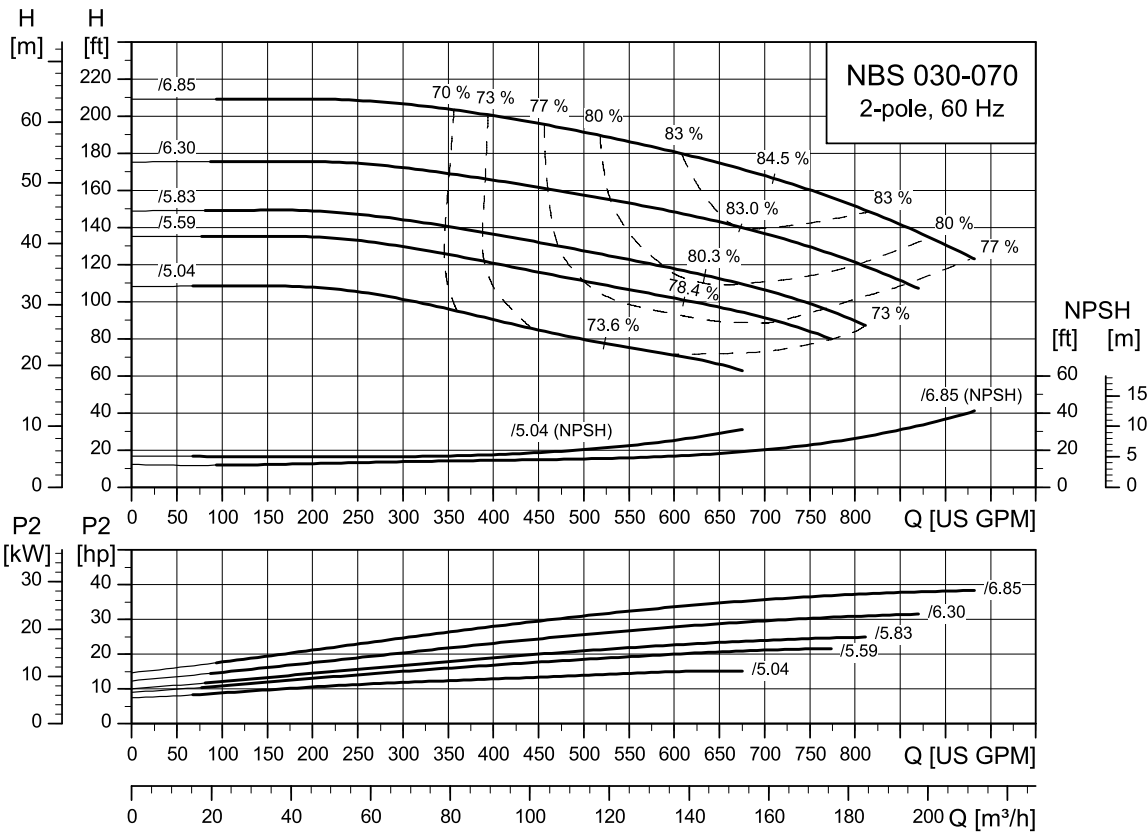

TM077521

**NBS 030-095**

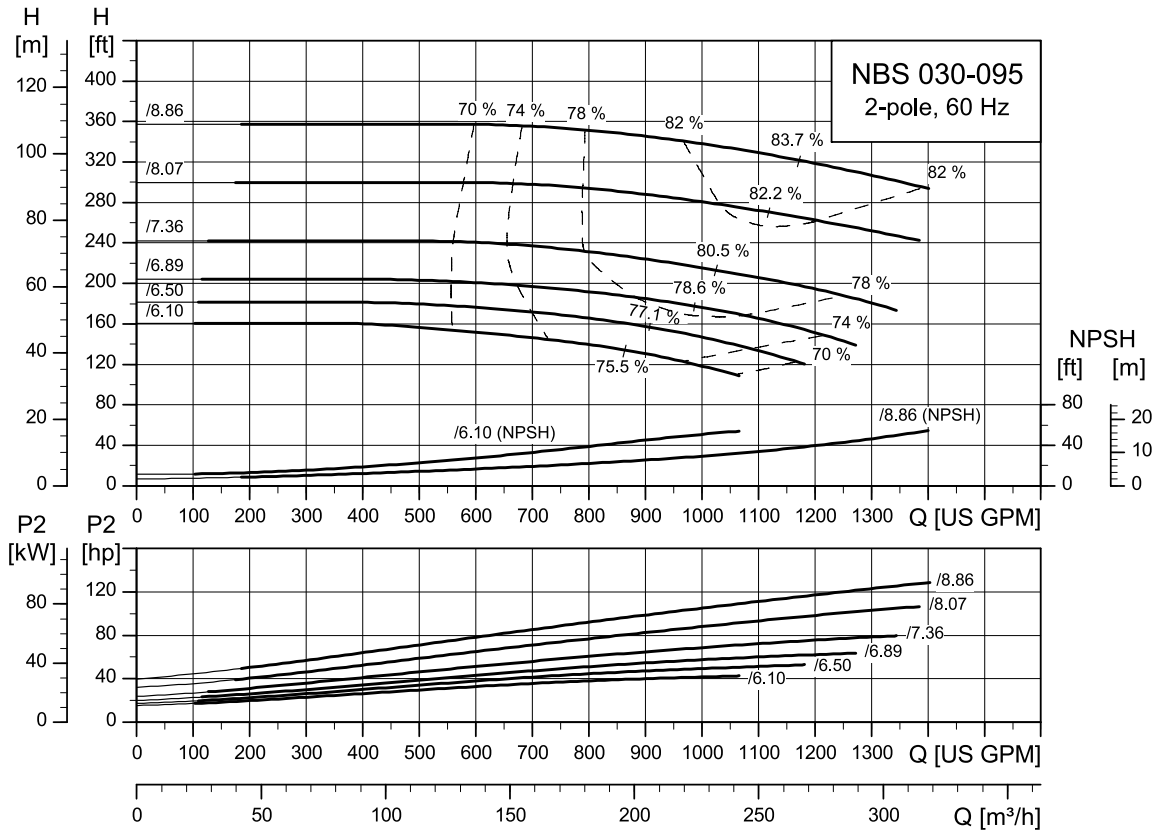

TM077523

**NBS 040-070**

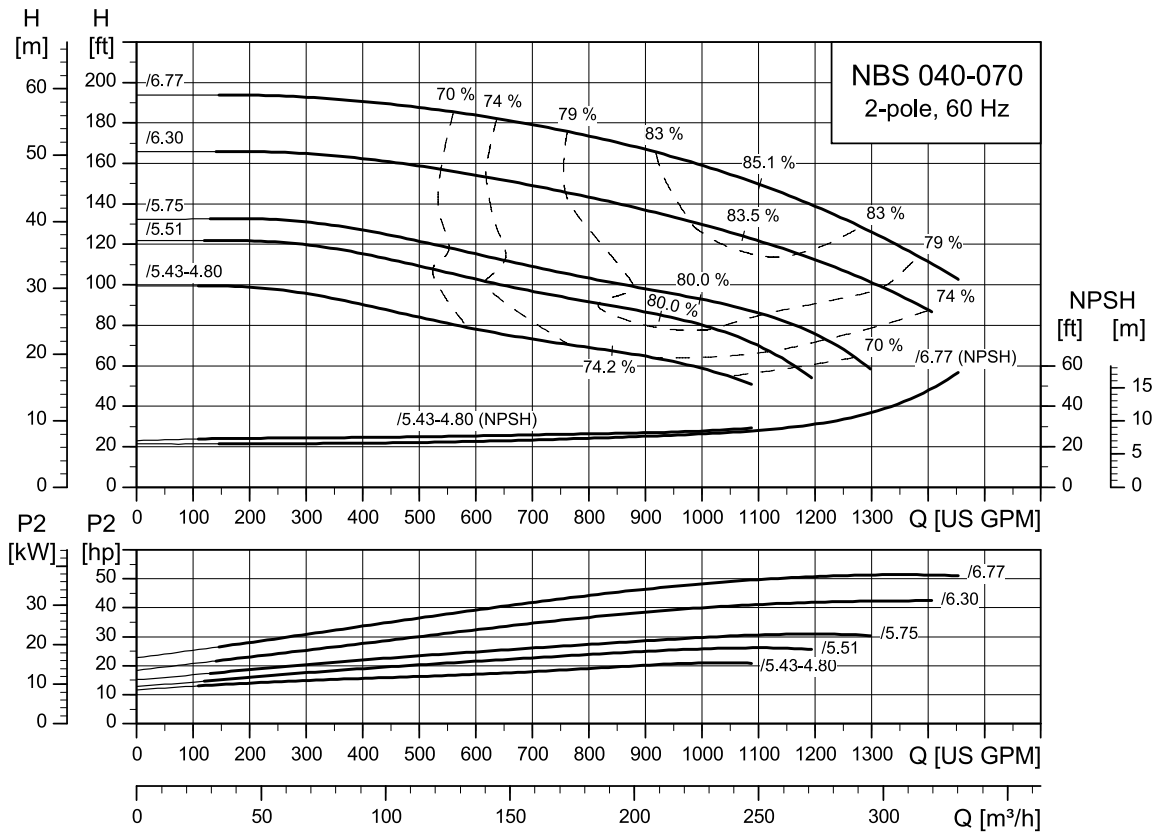

TM077526

**NBS 040-095**

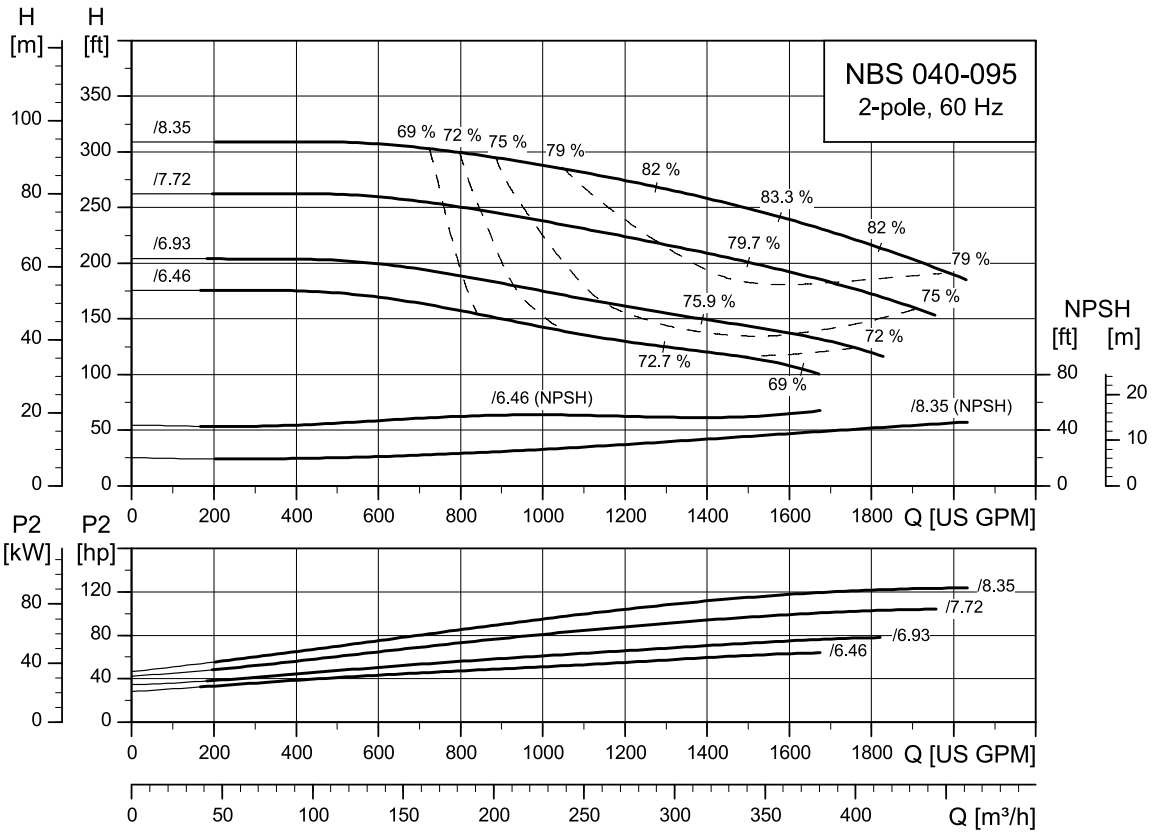

TM077304

**NBS 050-070**

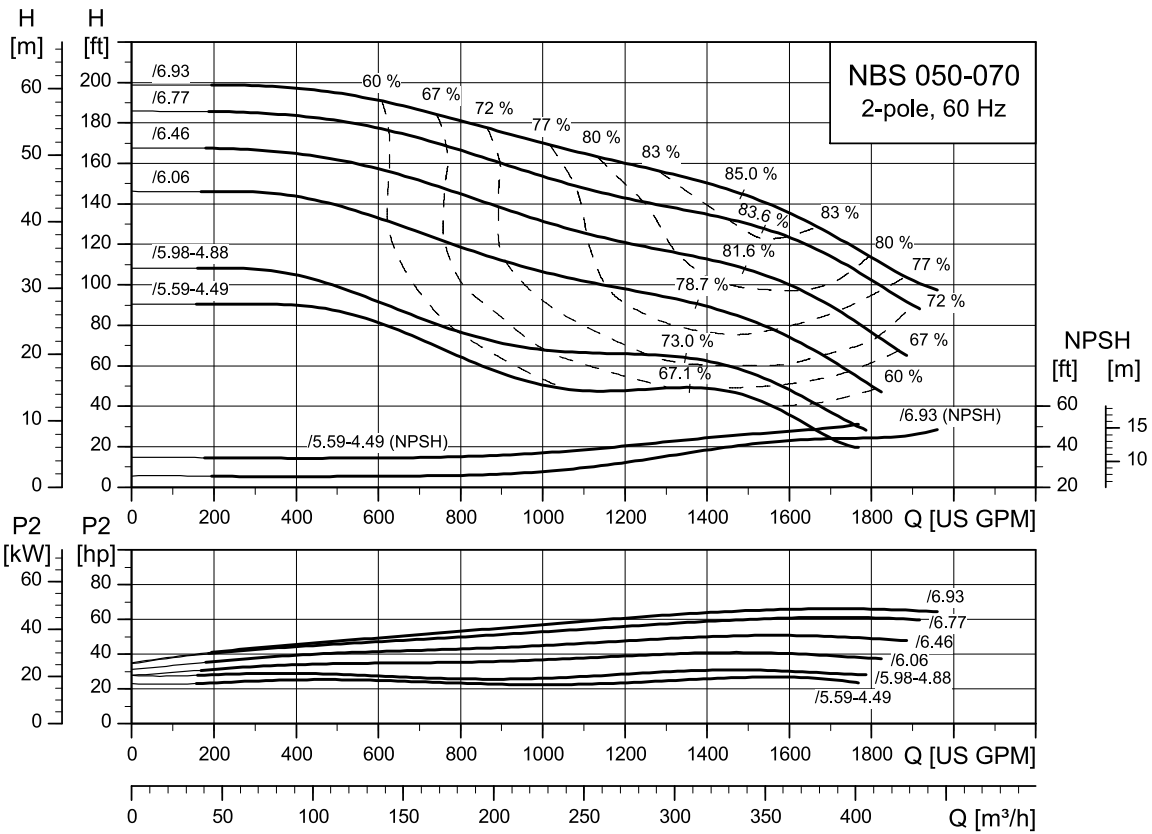

TM077817



### 4-pole

#### NBS 012-070

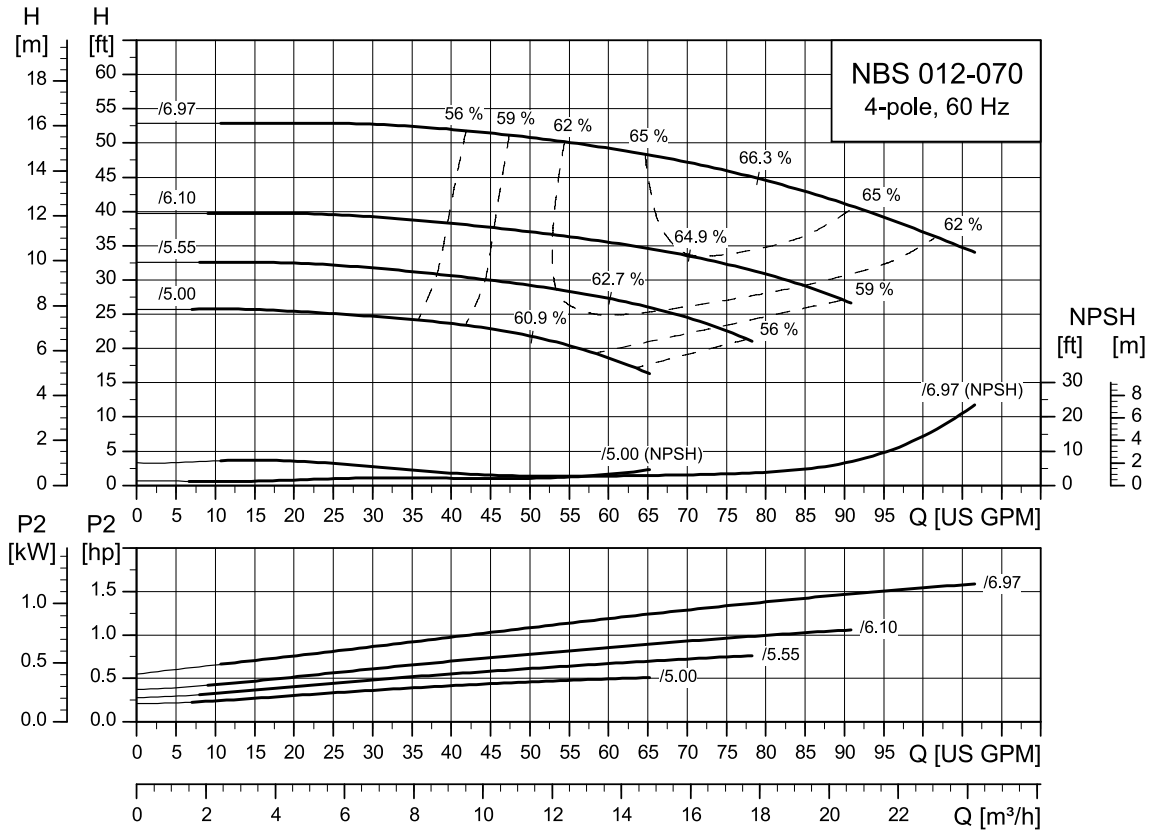

TM077806

#### NBS 015-070

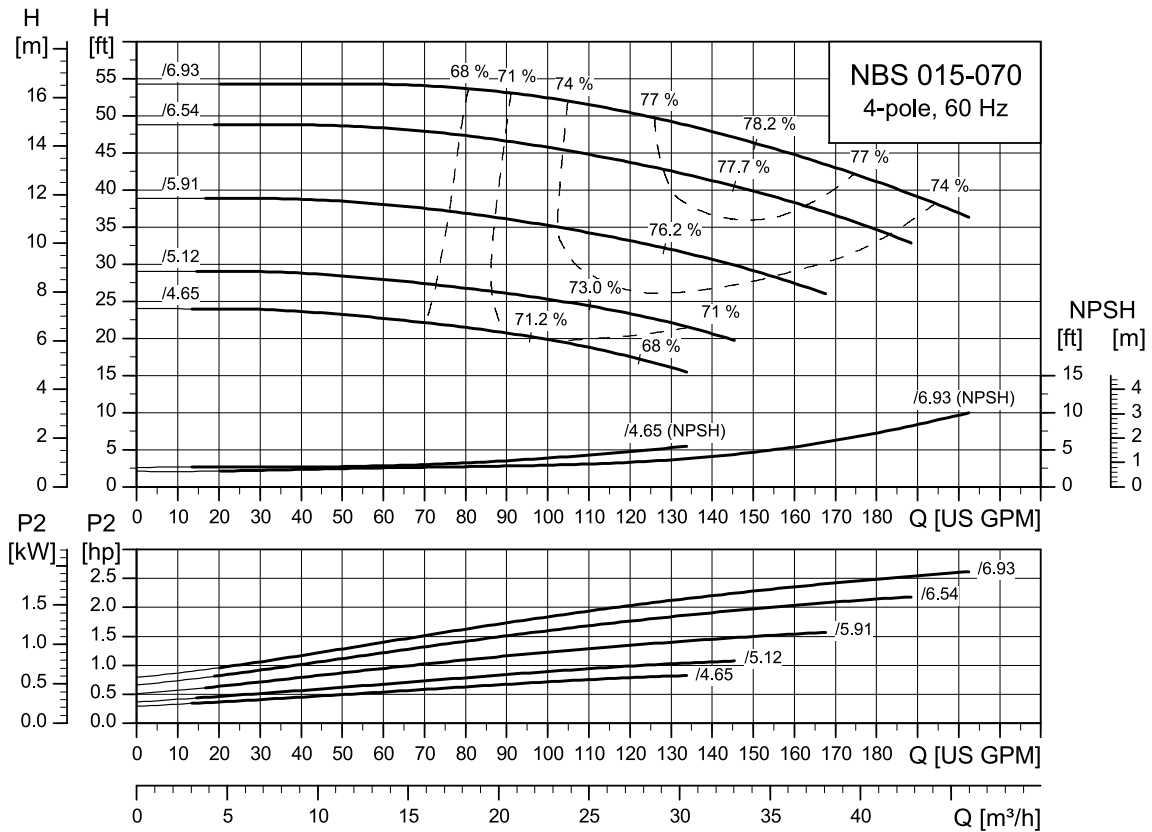

TM077514

**NBS 015-090**

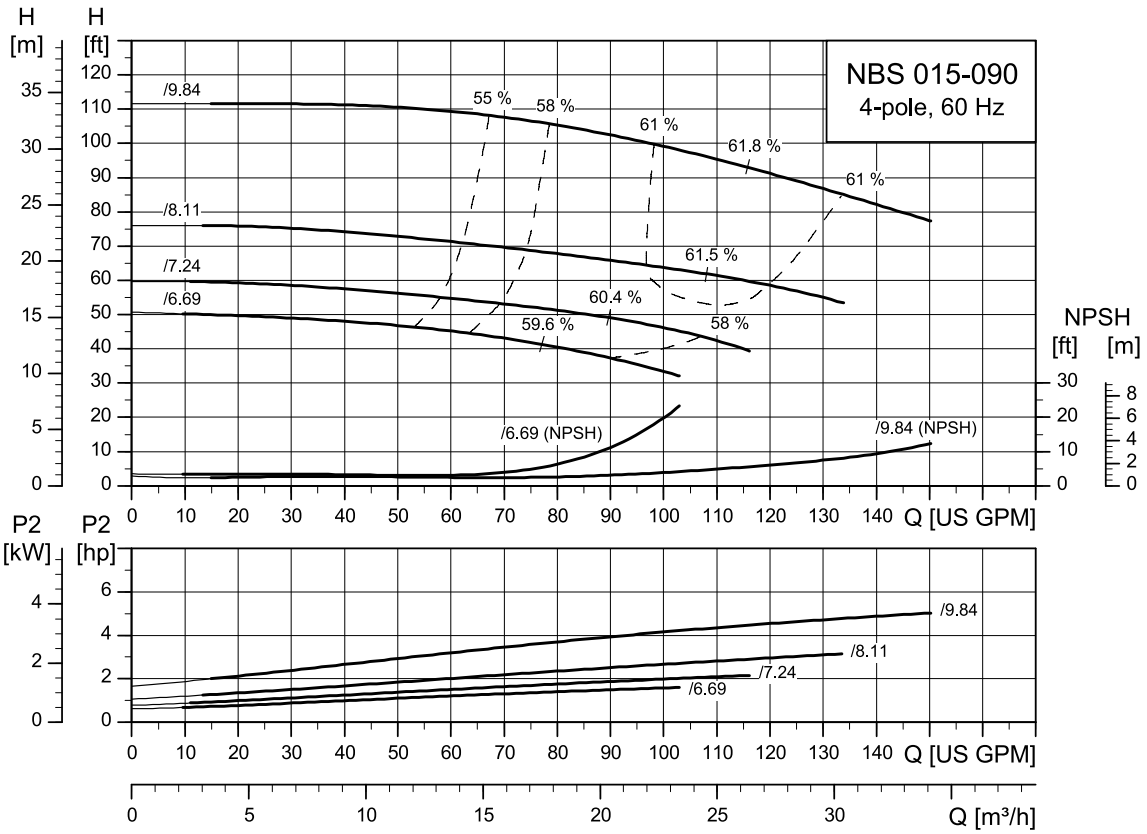

TM077808

**NBS 015-095**

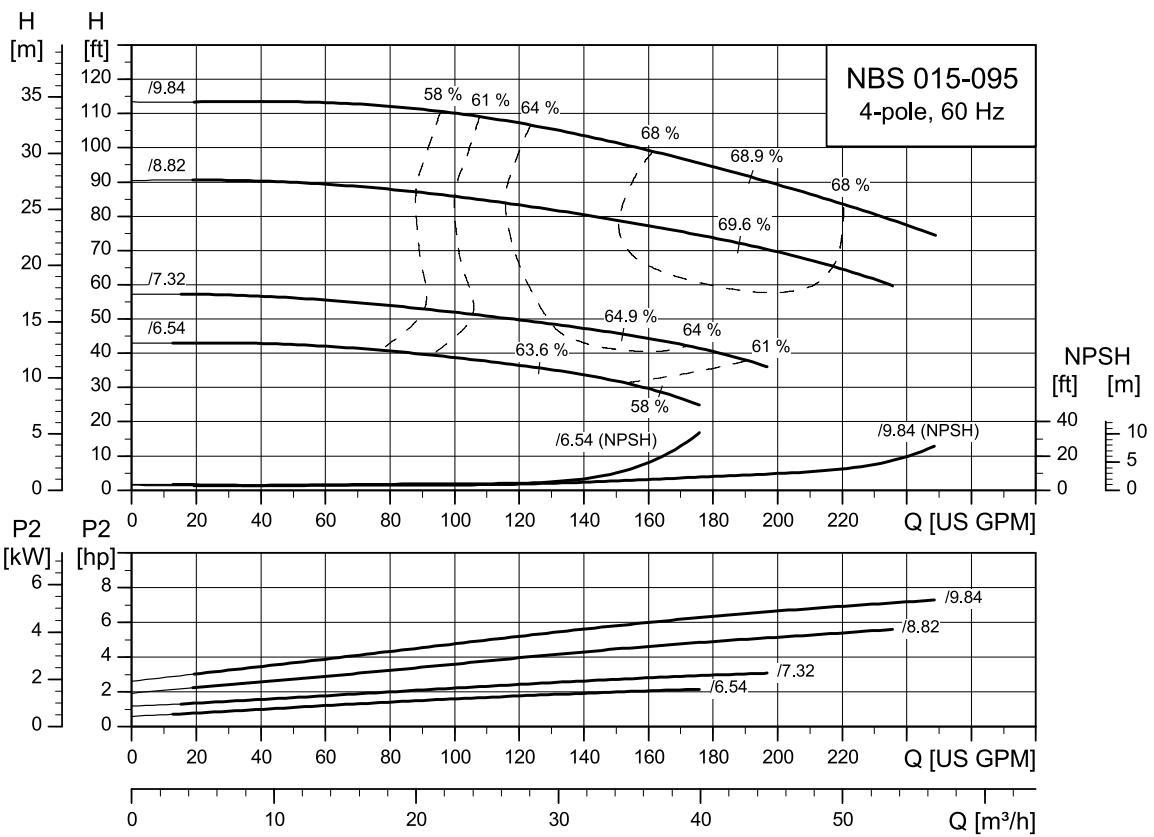

TM077810

**NBS 020-095**

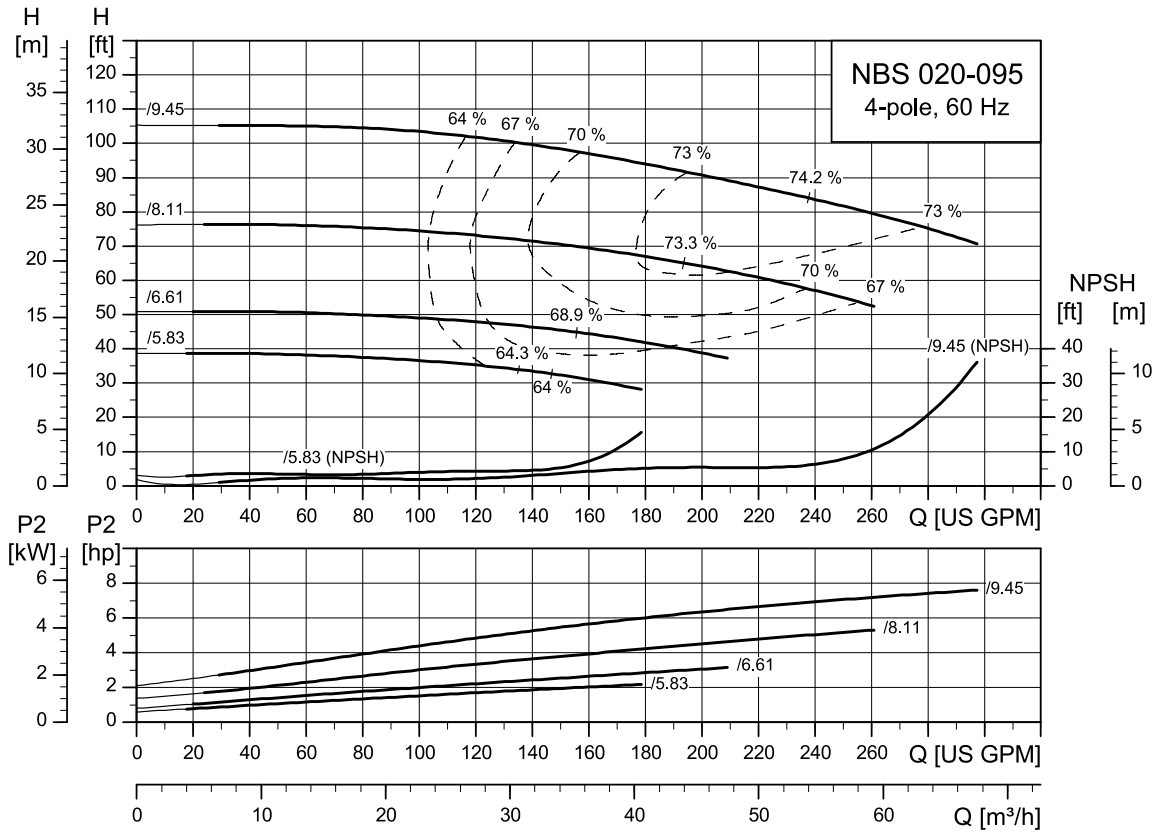

TM077516

**NBS 020-110**

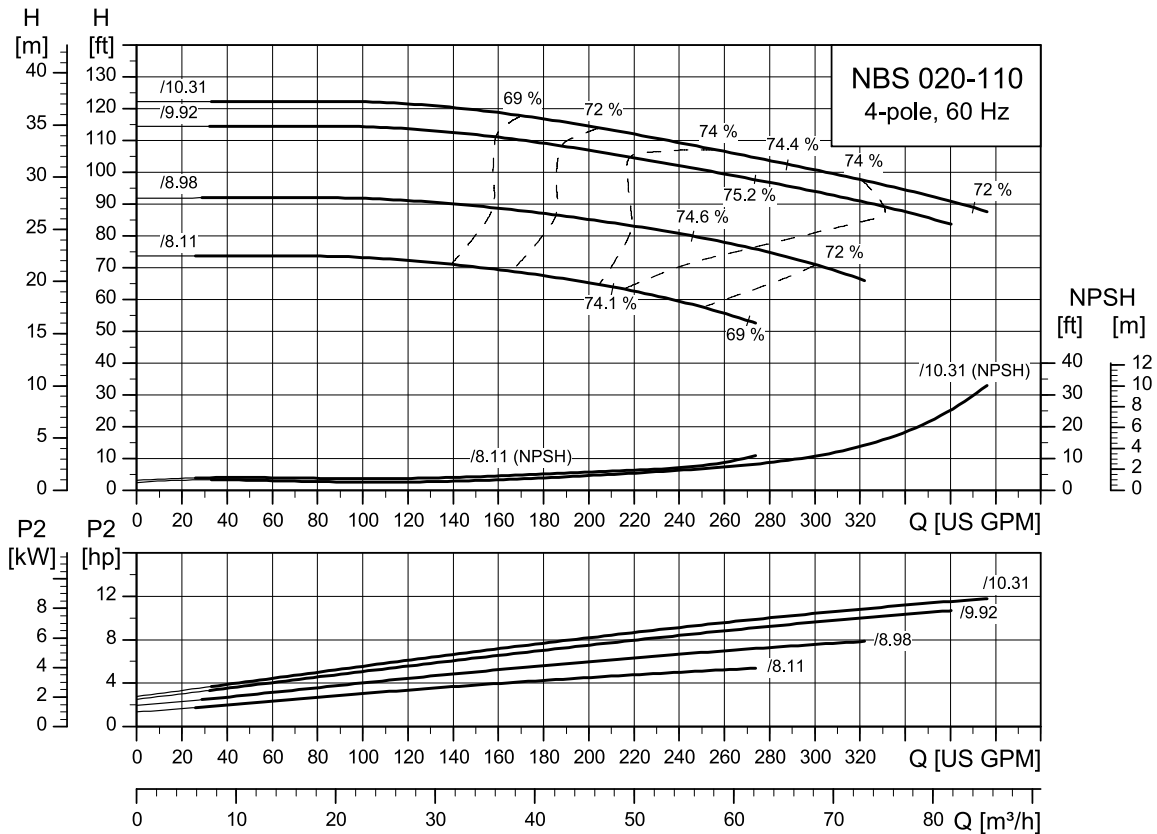

TM077517

**NBS 020-135**

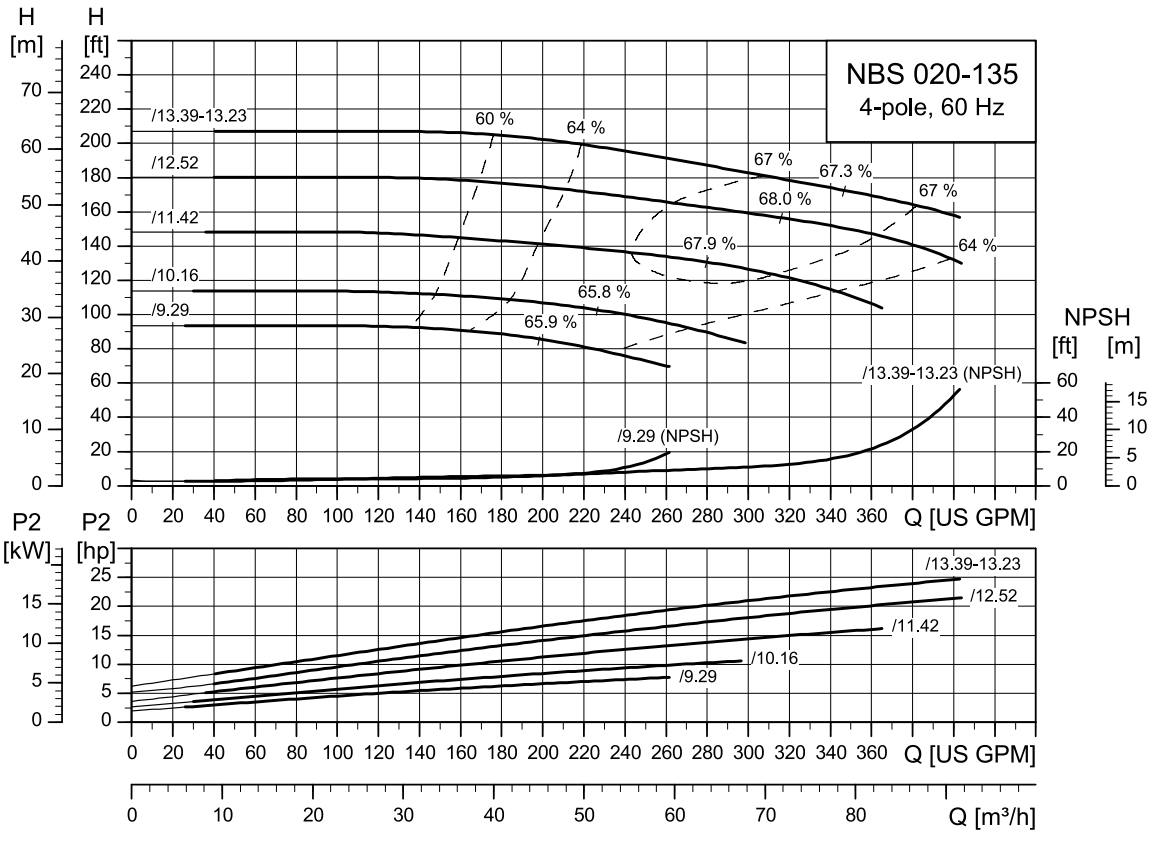

TM077518

**NBS 025-070**

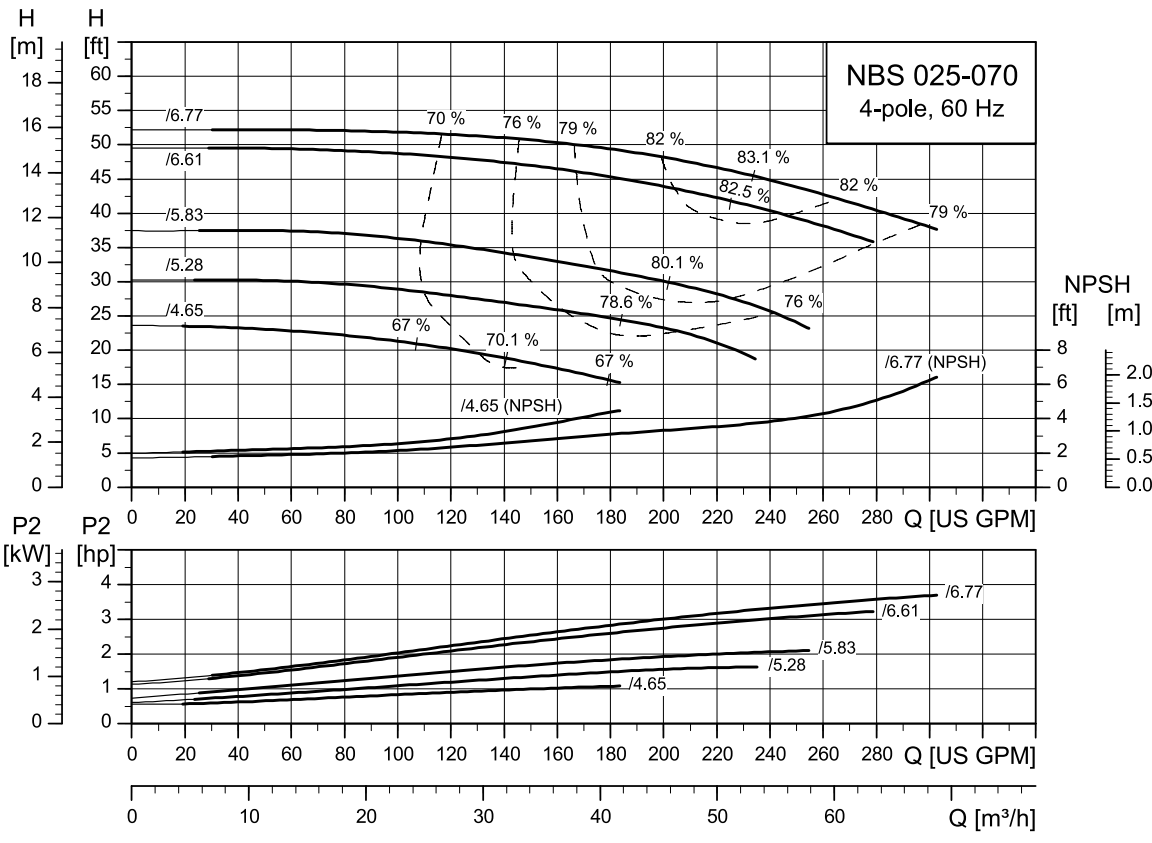

TM077812

**NBS 025-095**

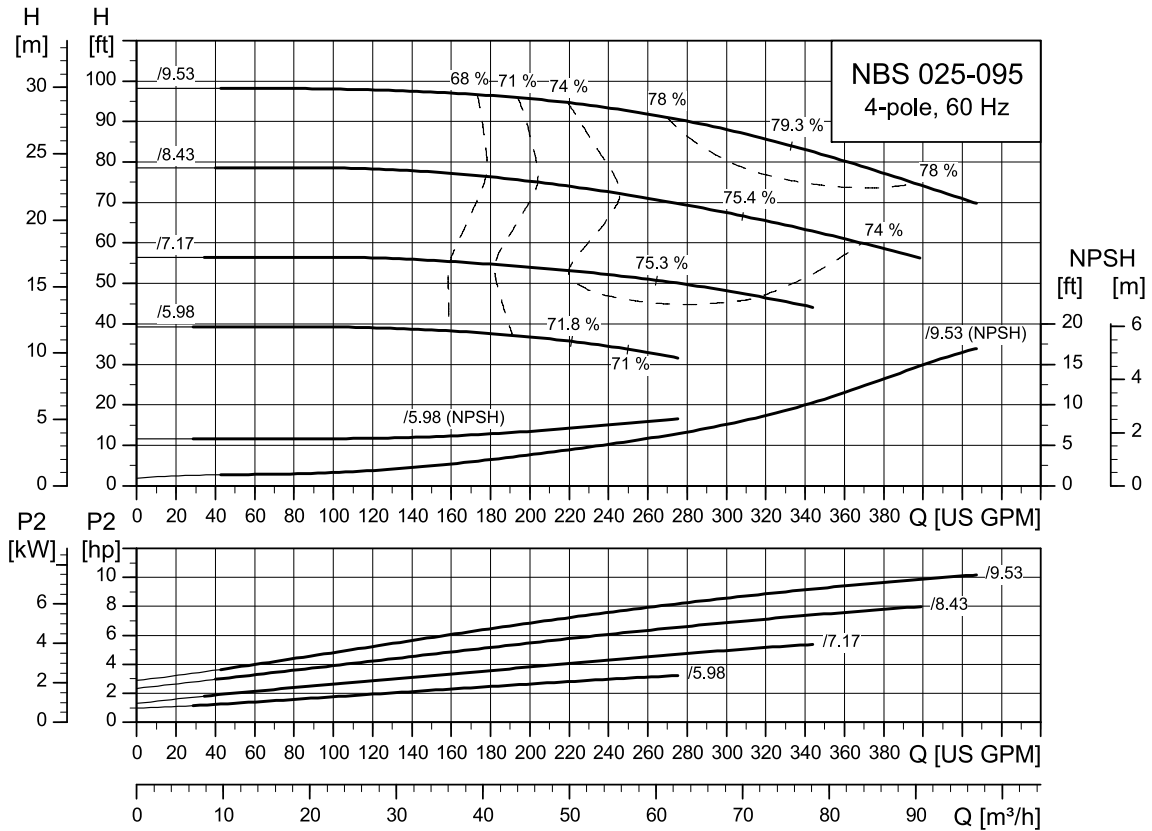

TM077305

**NBS 025-110**

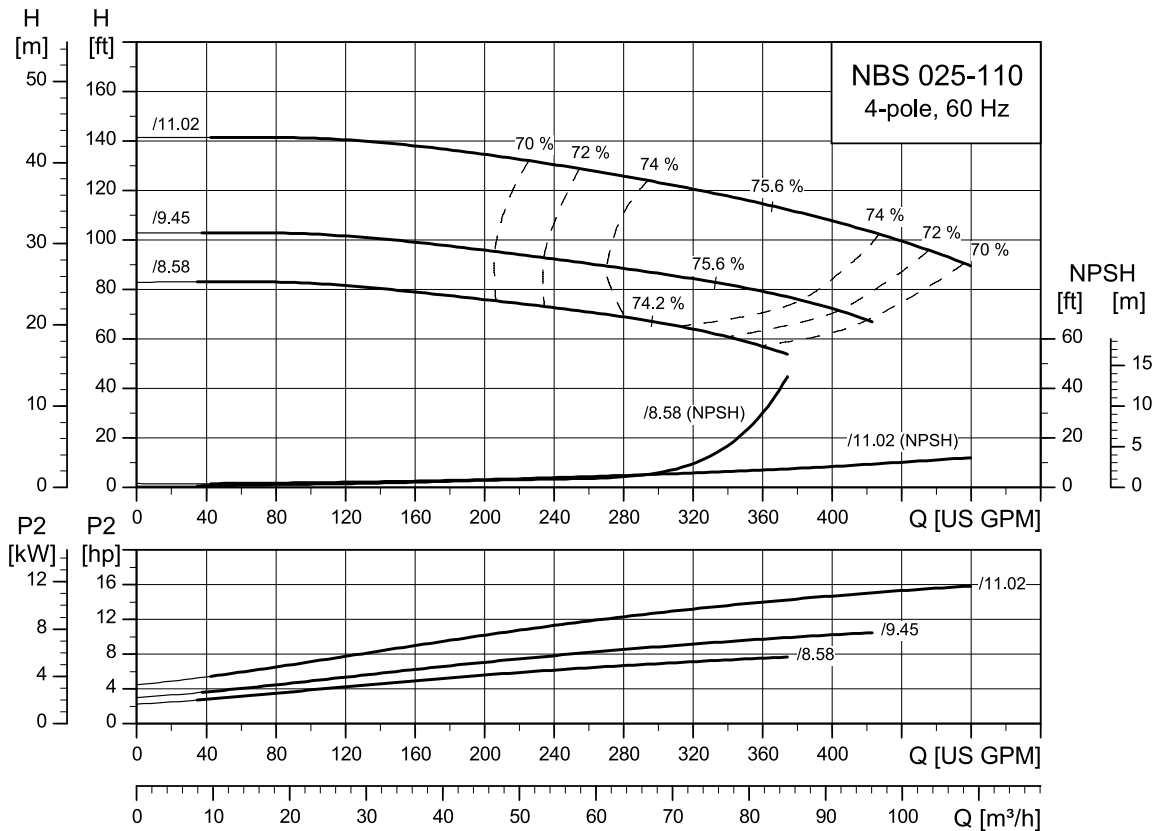

TM077519

**NBS 030-070**

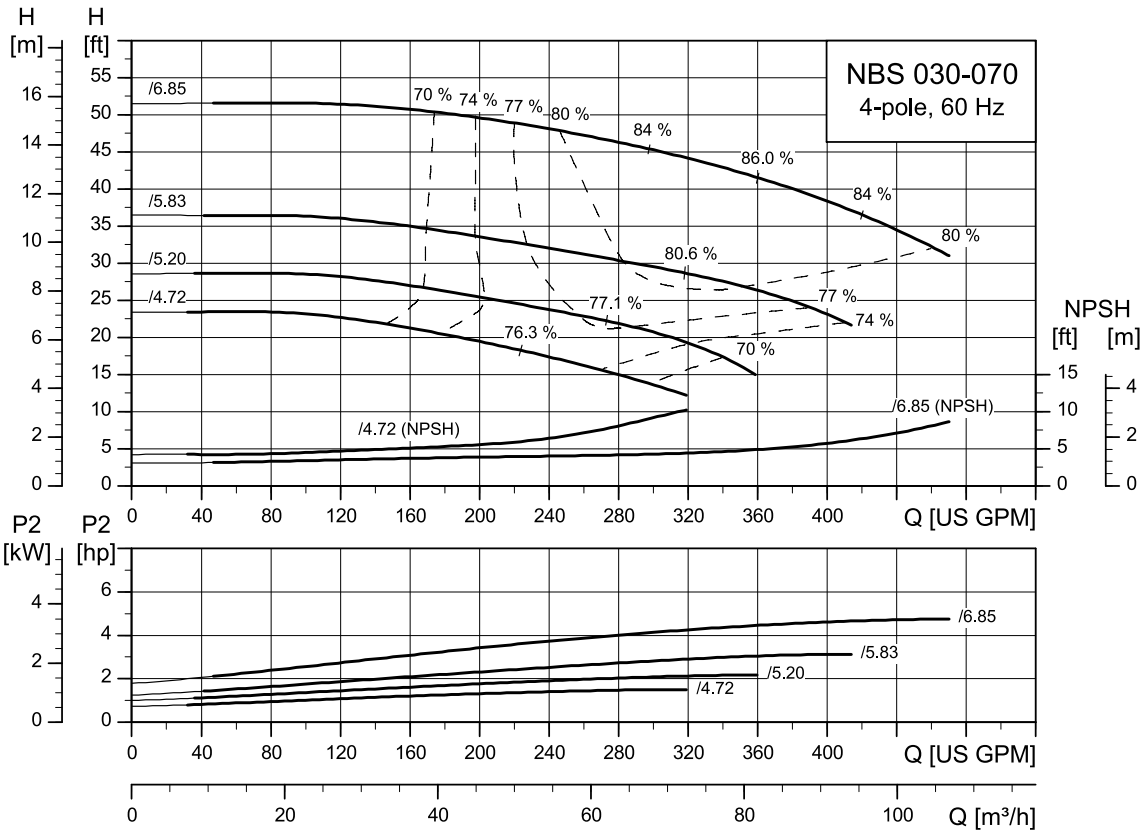

TM077522

**NBS 030-095**

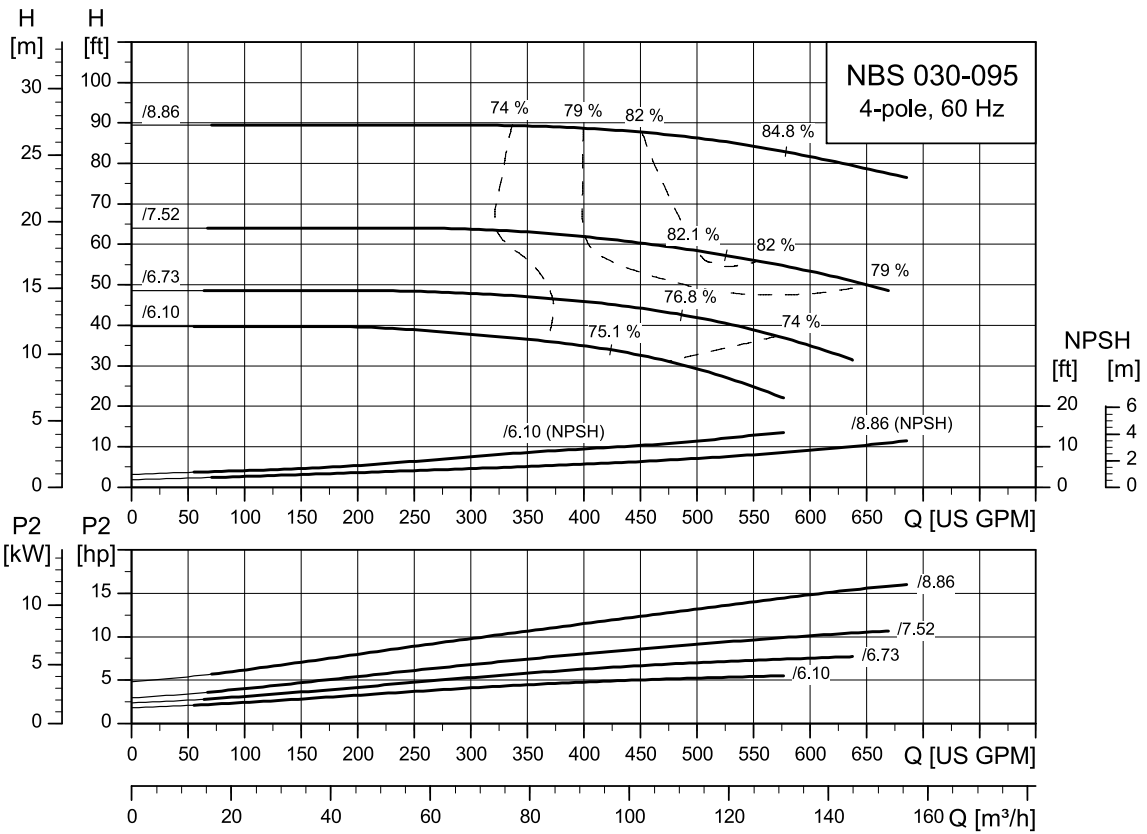

TM077524

**NBS 030-110**

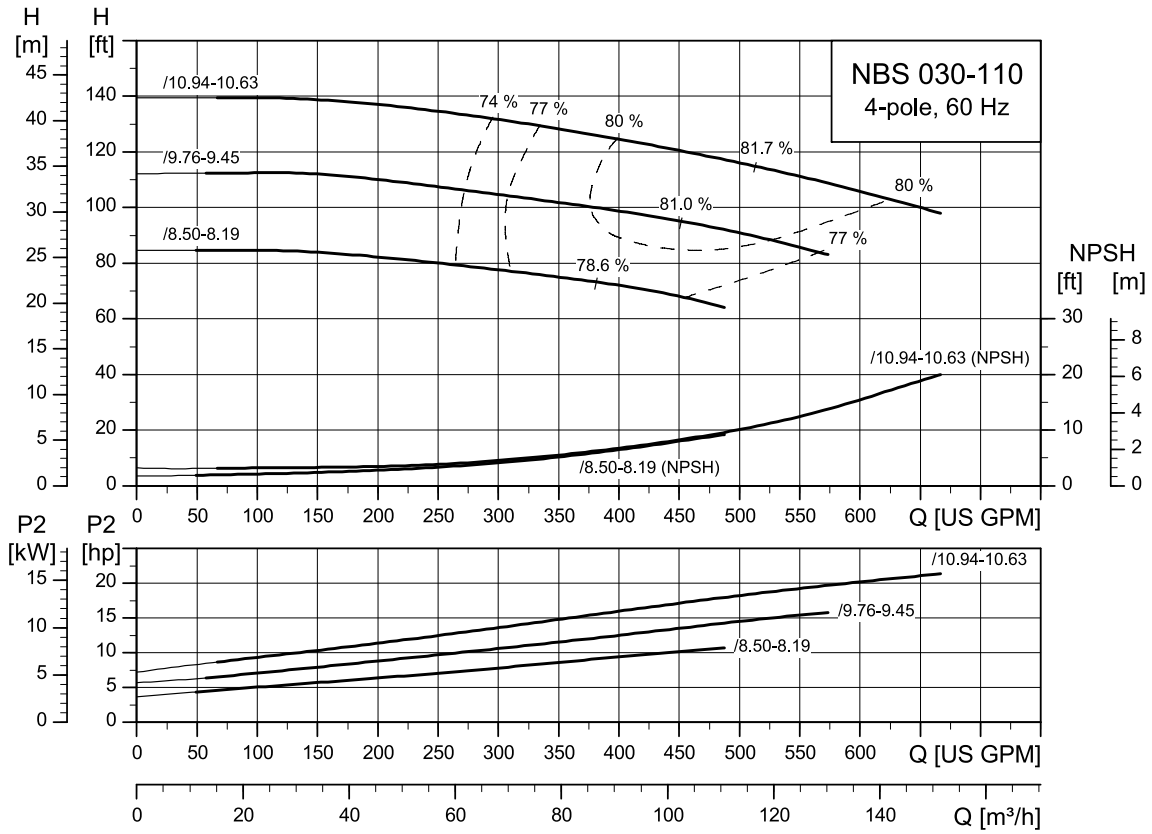

TM077306

**NBS 030-135**

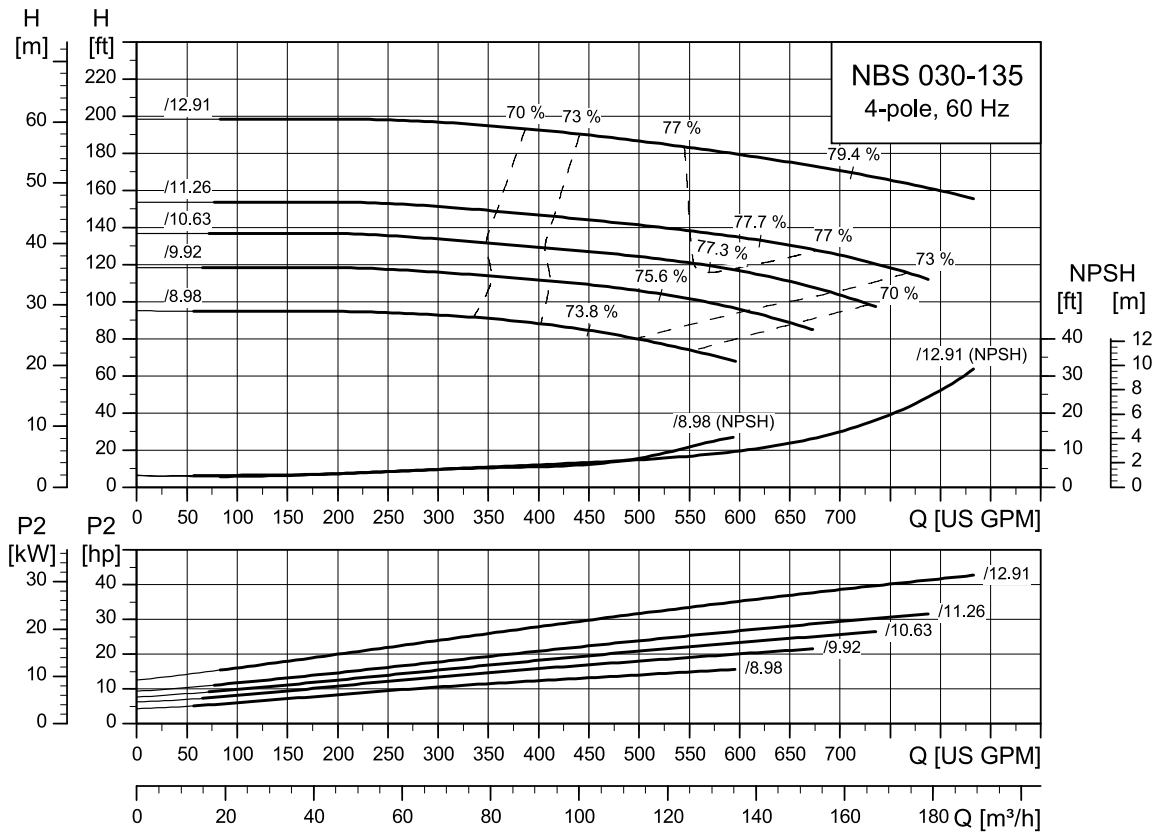

TM077813

**NBS 040-070**

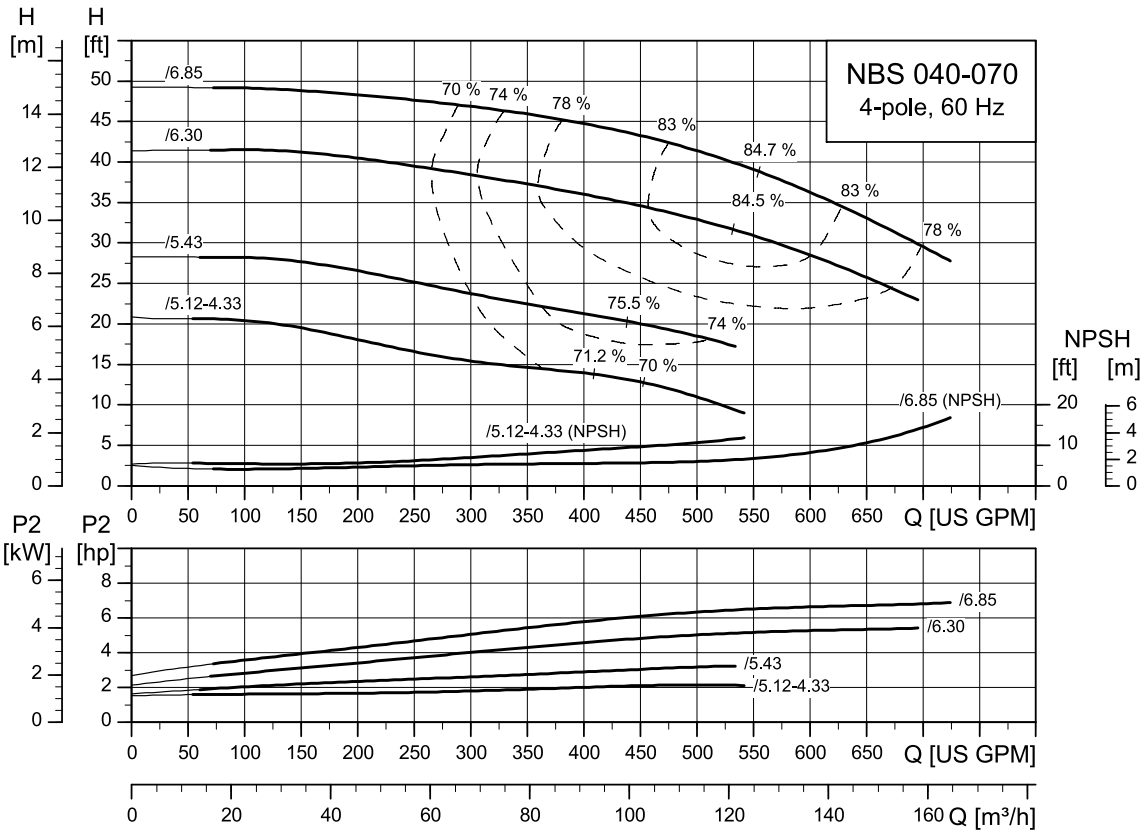

TM07527

**NBS 040-095**

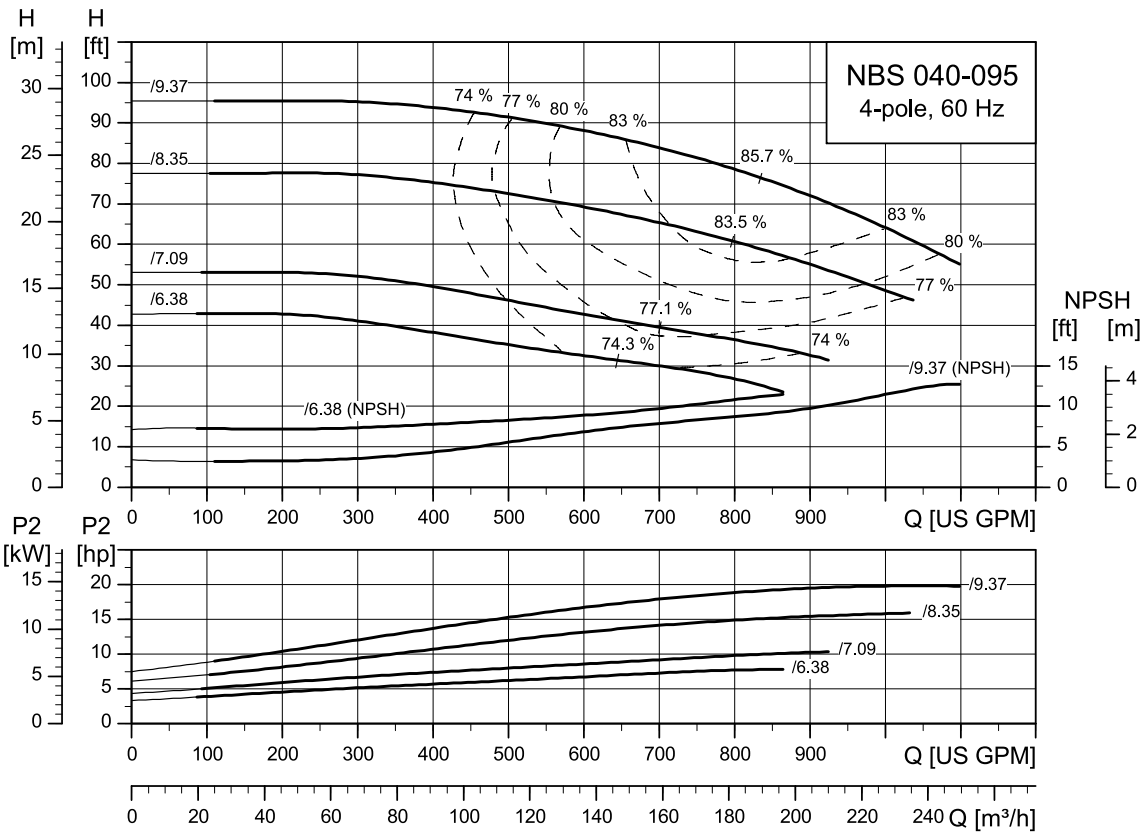

TM07507



**NBS 040-110**

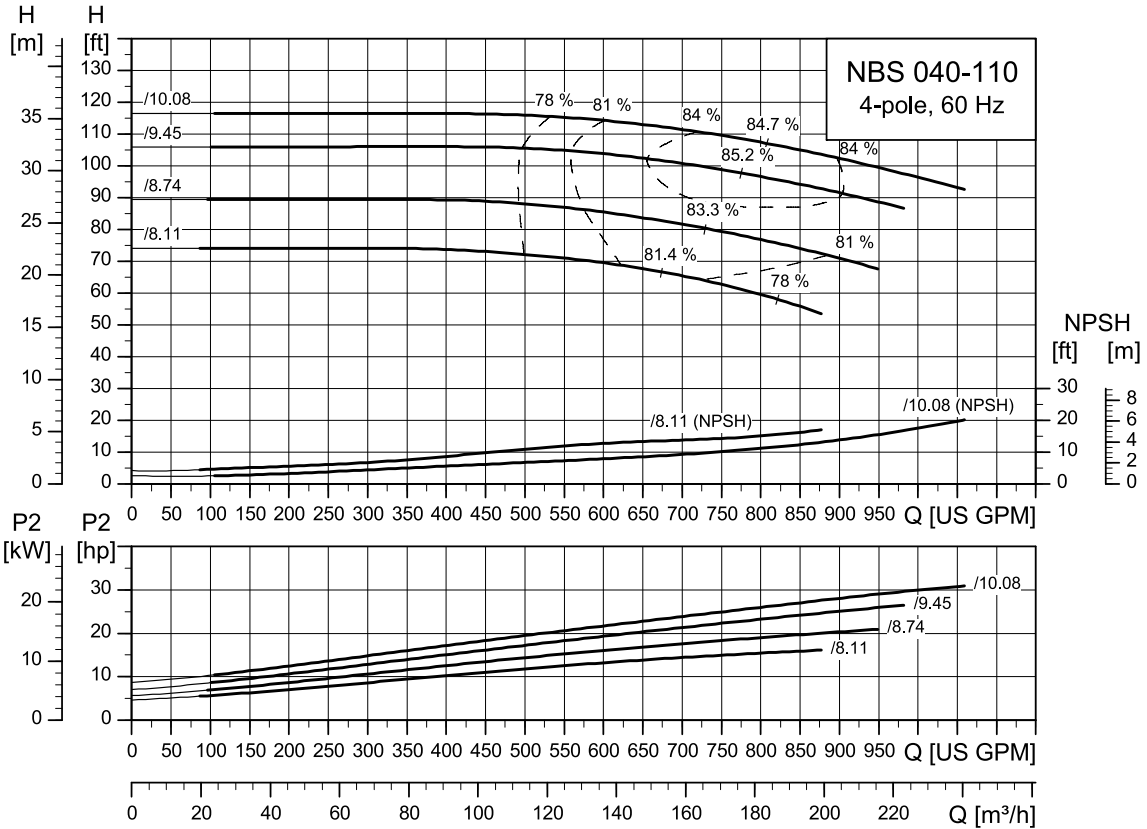

TM077815

**NBS 040-135**

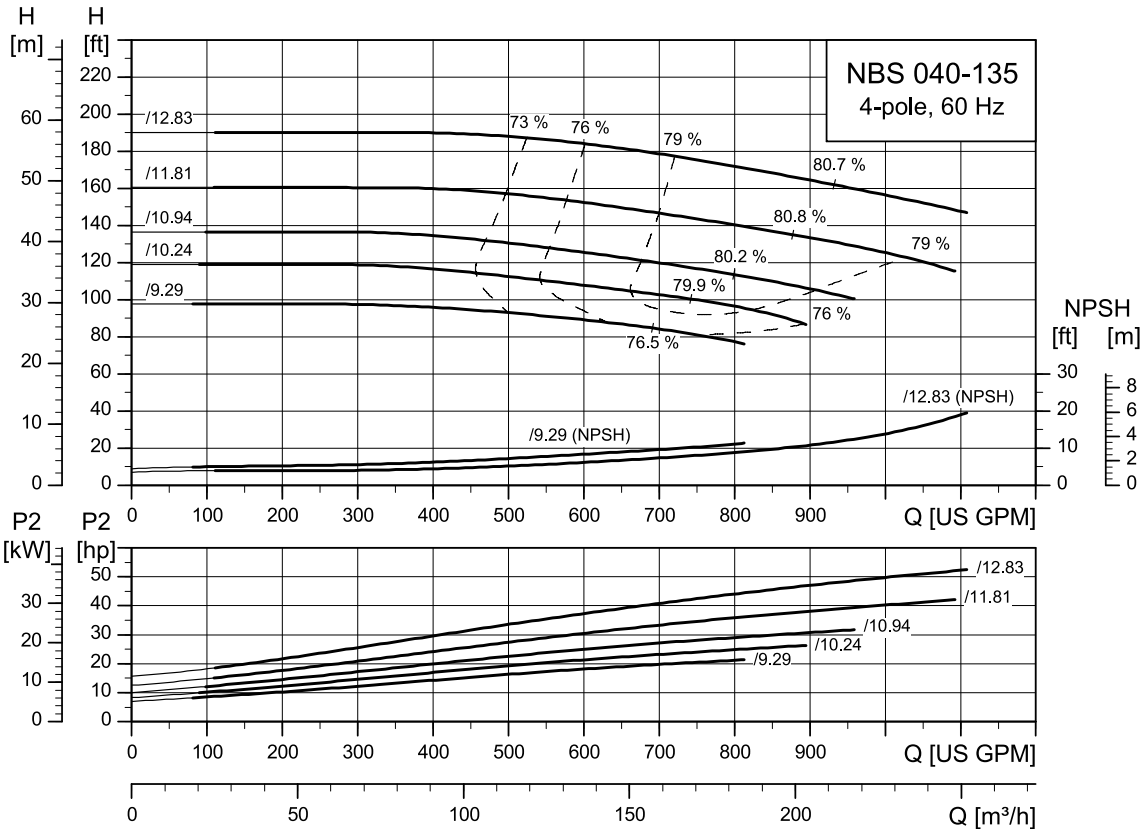

TM077529

**NBS 040-150**

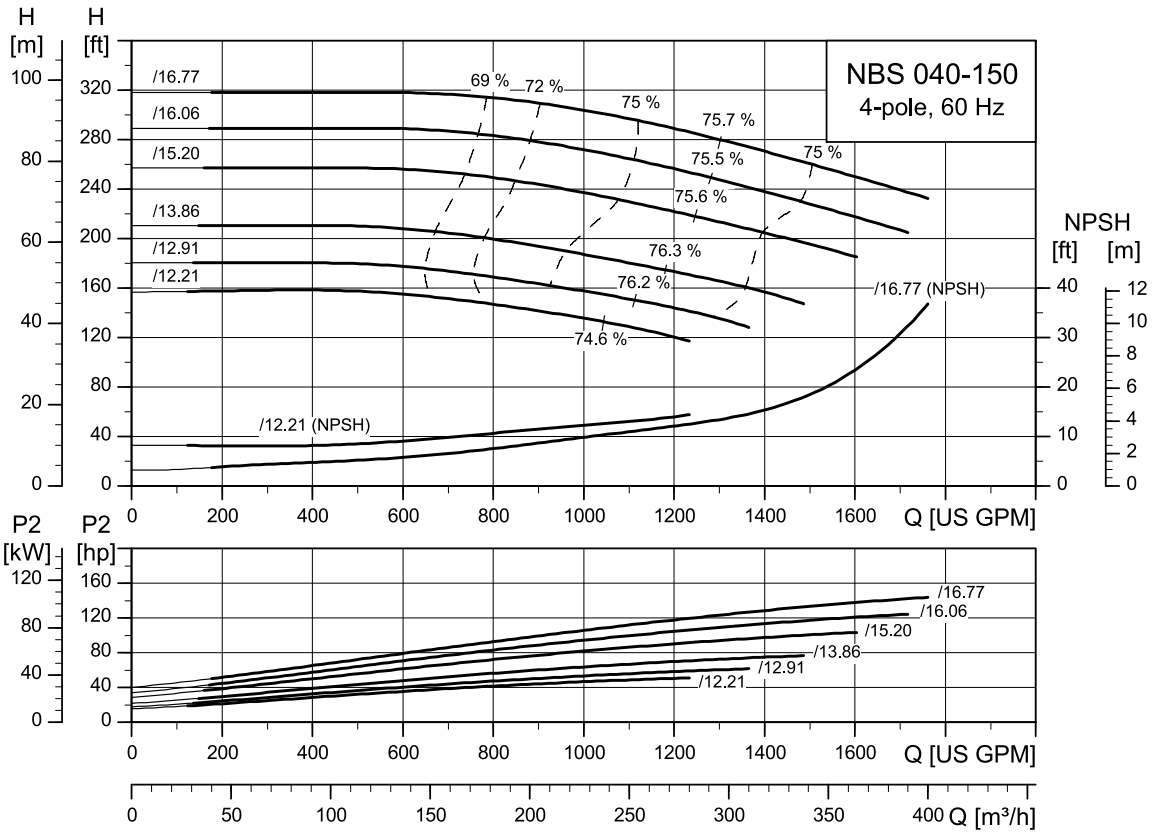

TM077313

**NBS 050-070**

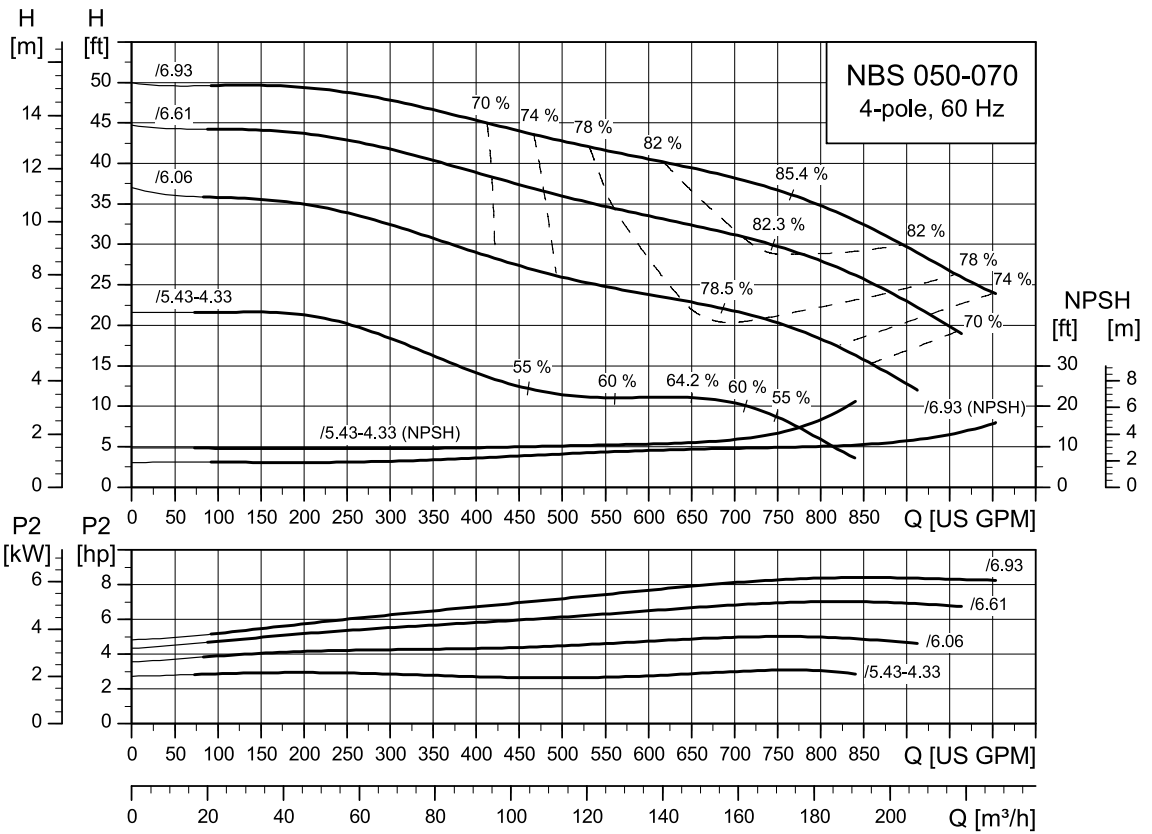

TM077818

**NBS 050-095**

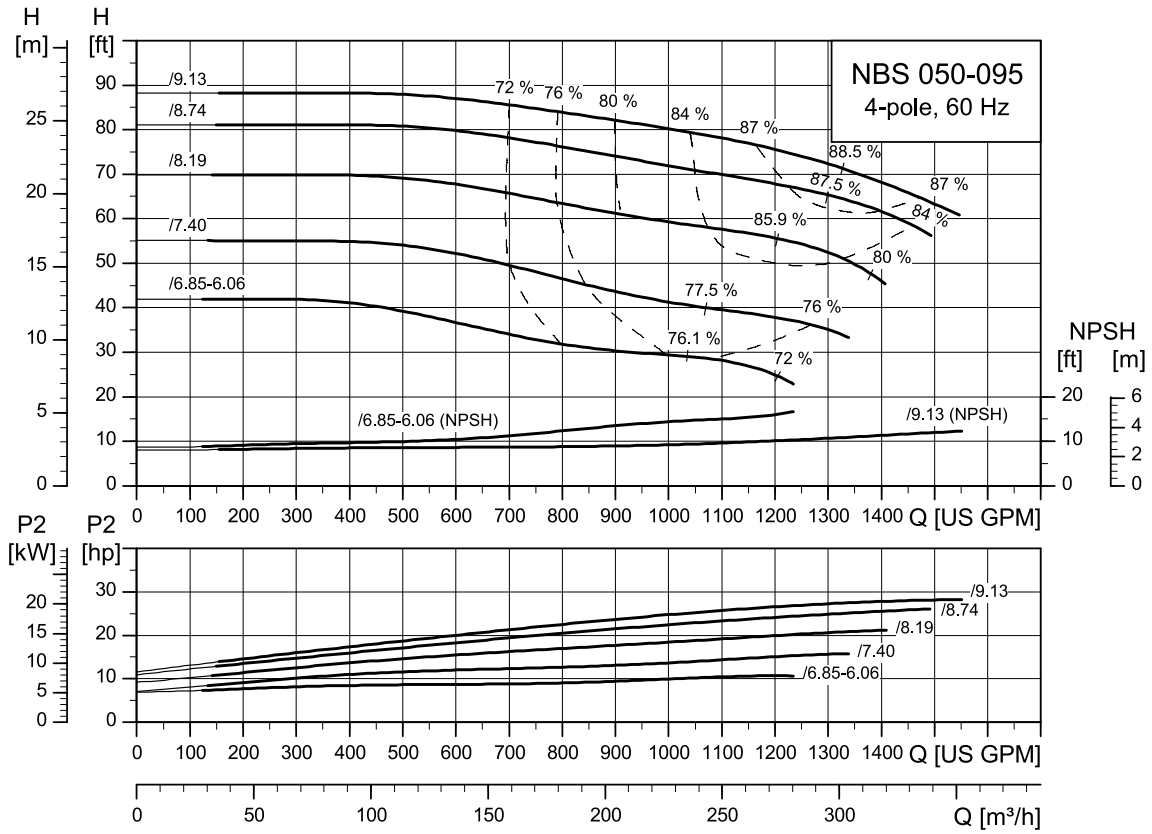

TM07308

**NBS 050-110**

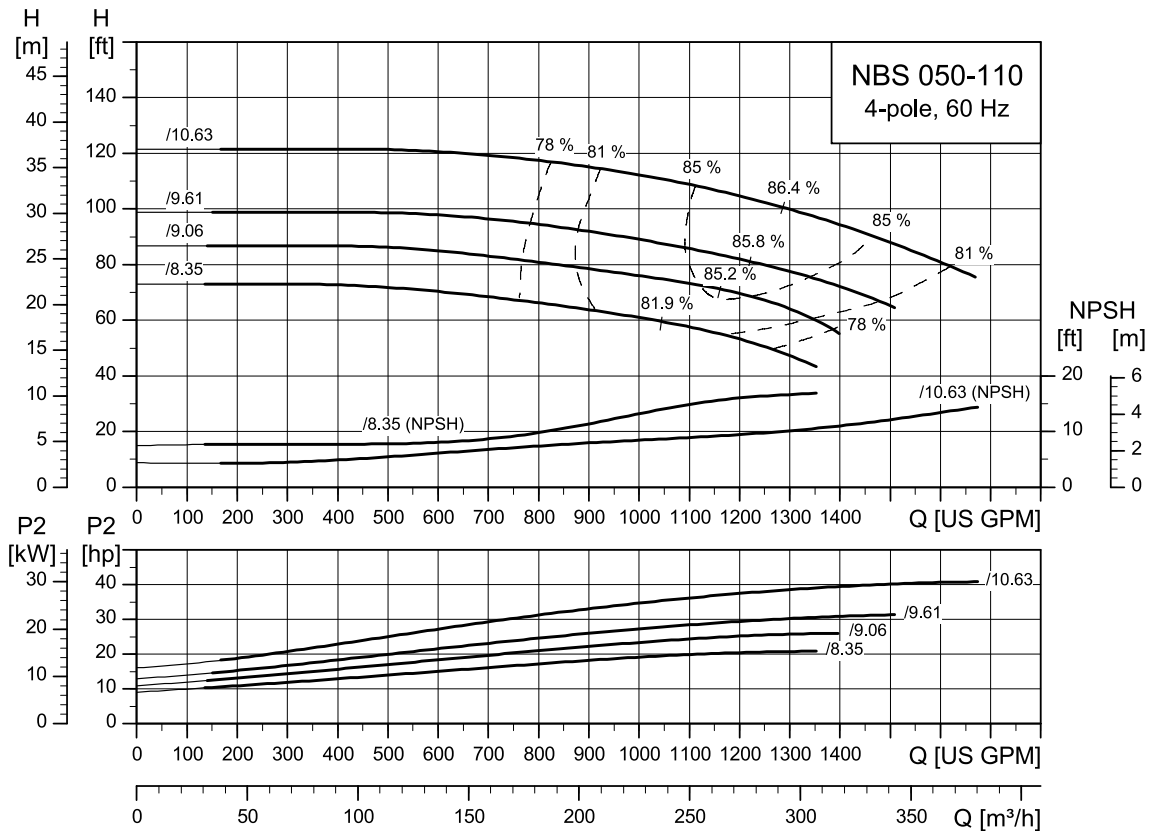

TM07310

**NBS 050-135**

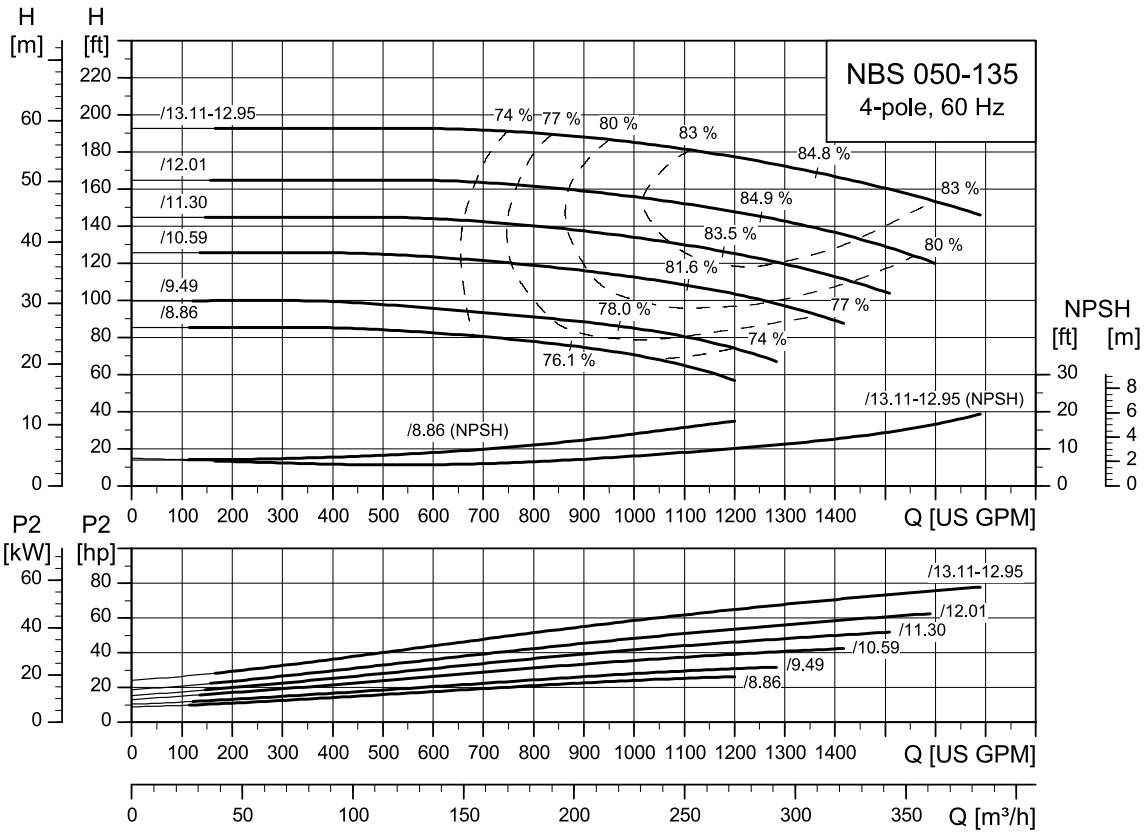

TM077620

**NBS 050-150**

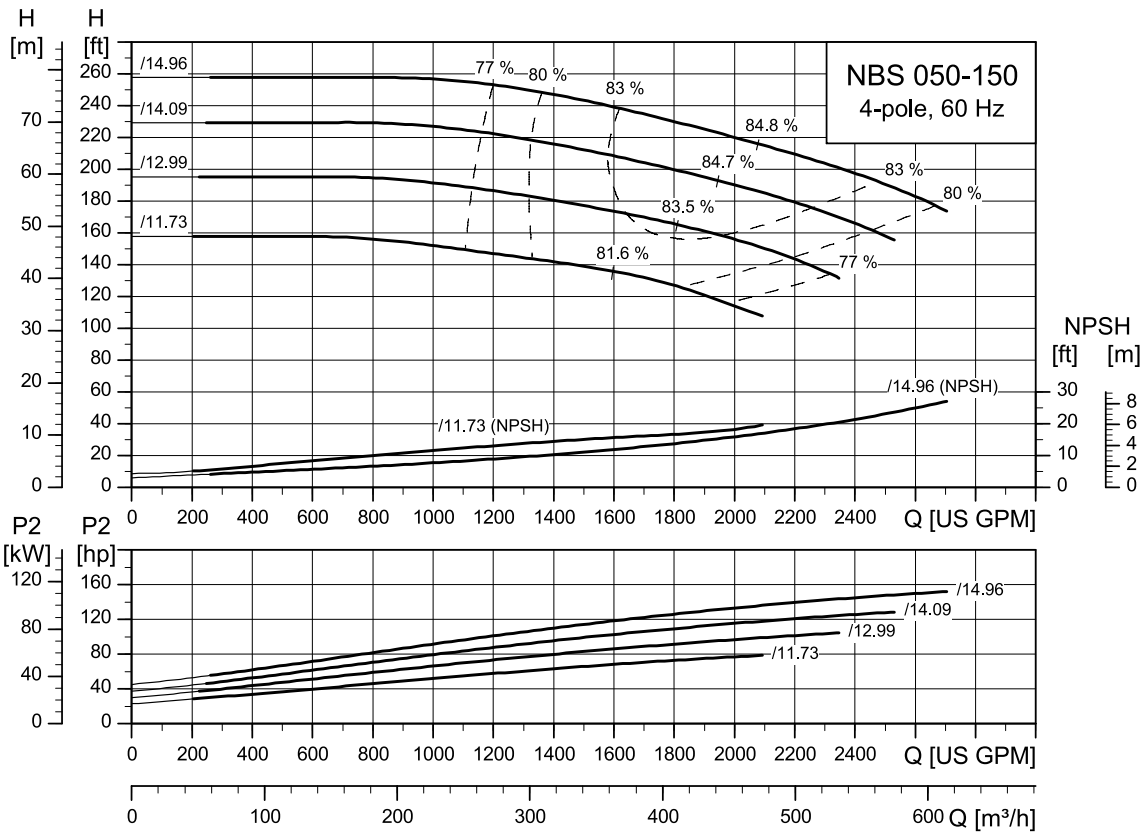

TM077531

**NBS 060-095**

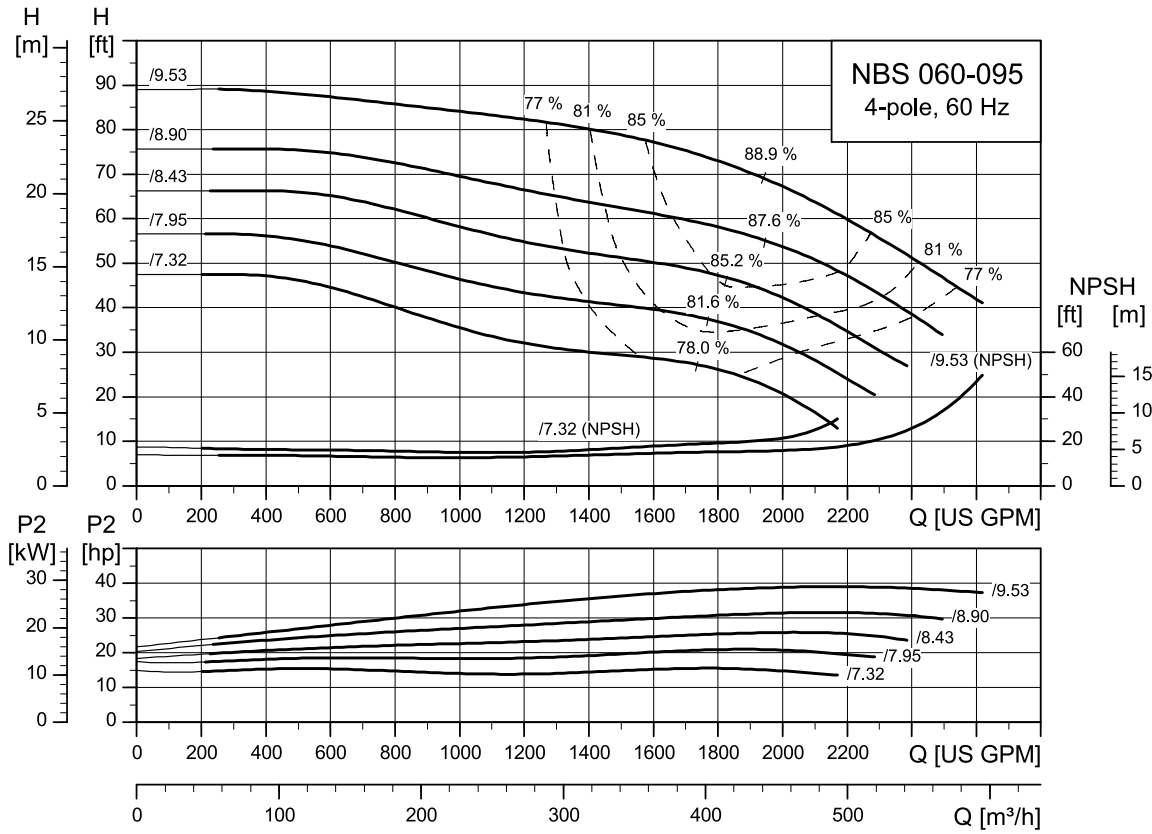

TM07533

**NBS 060-110**

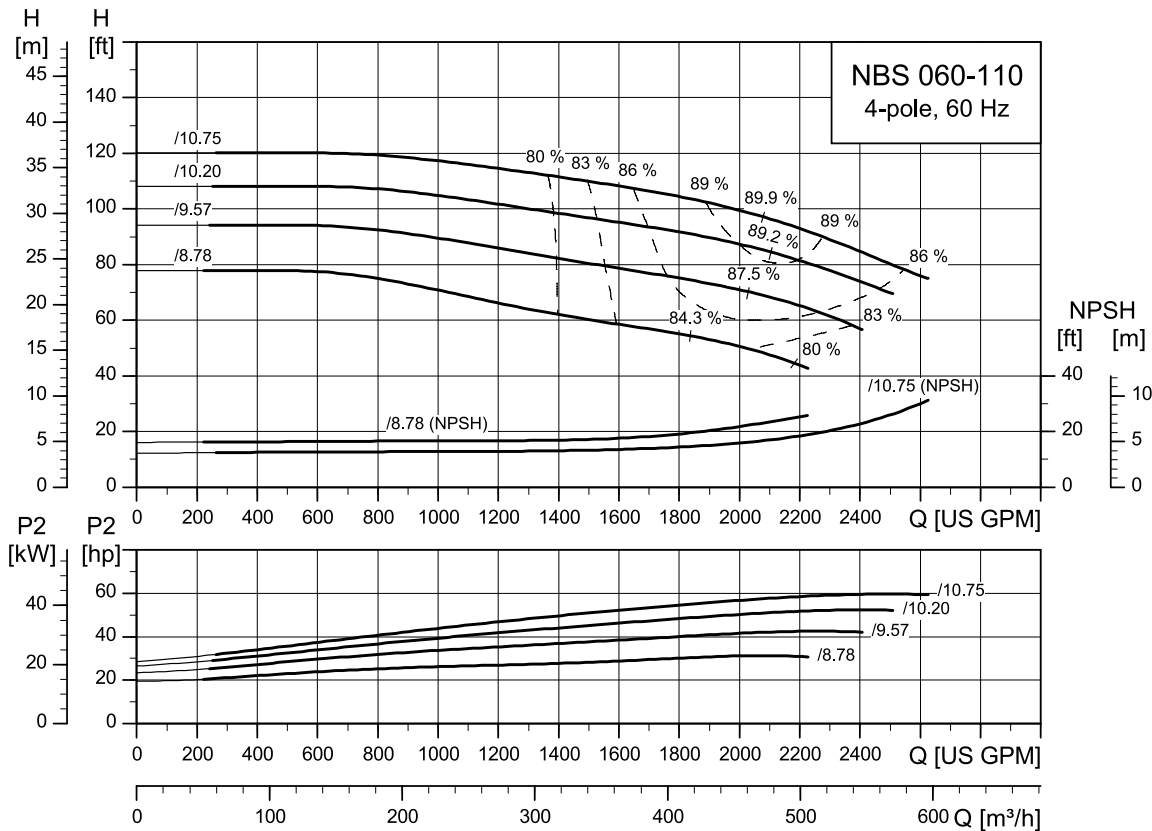

TM077311

**NBS 060-135**

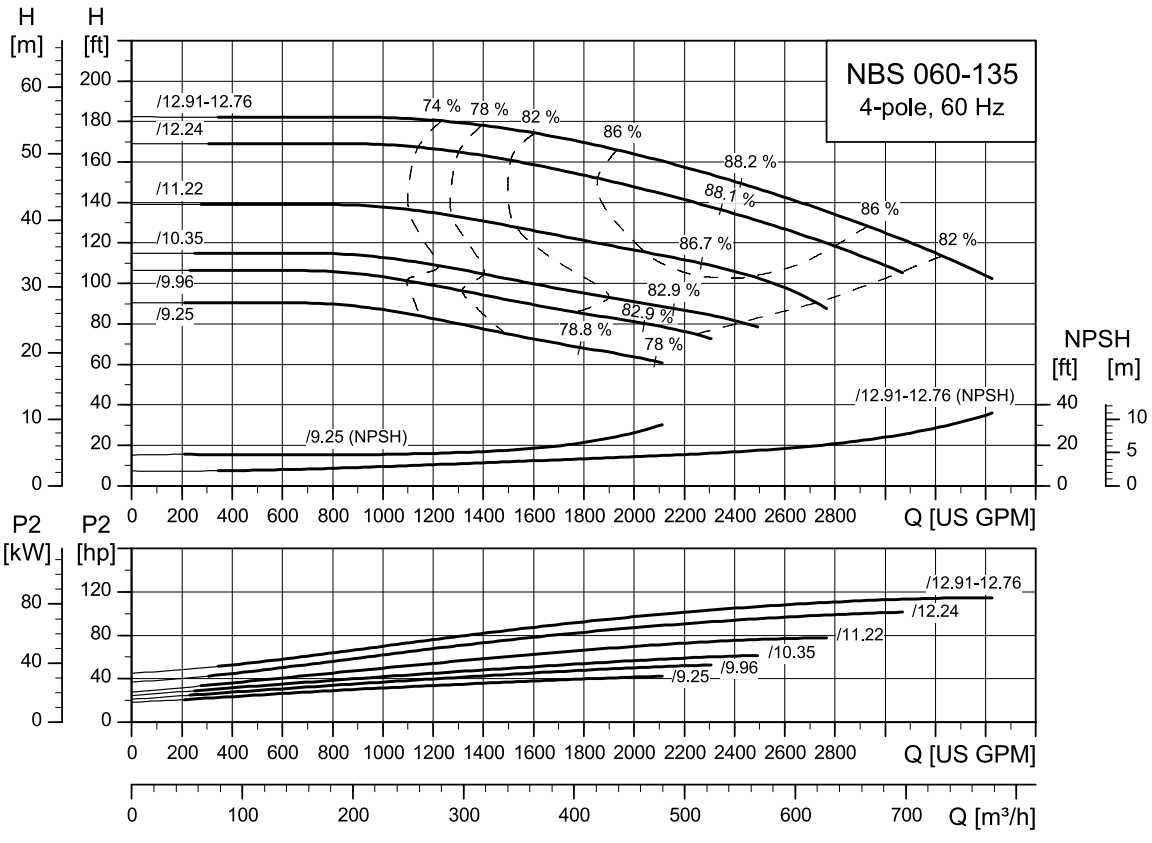

TM07309

**NBS 060-150**

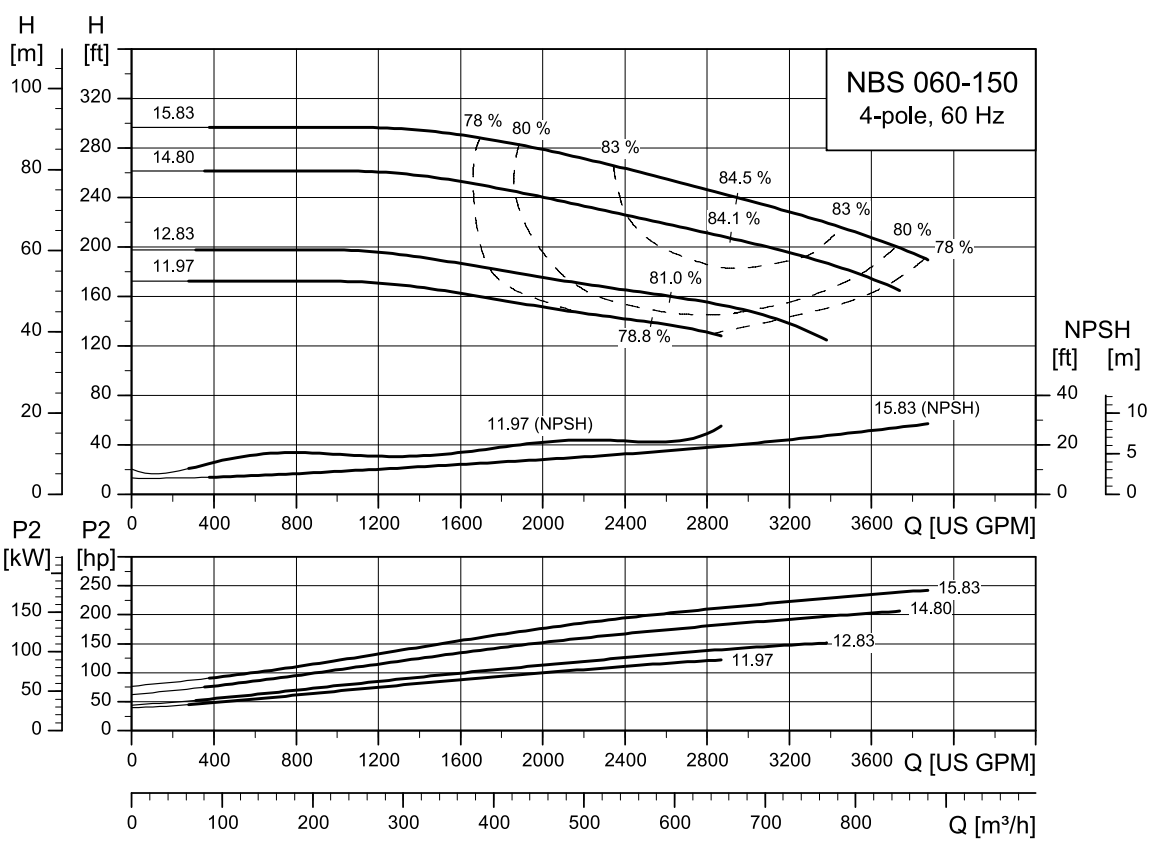

TM077622

**NBS 080-135**

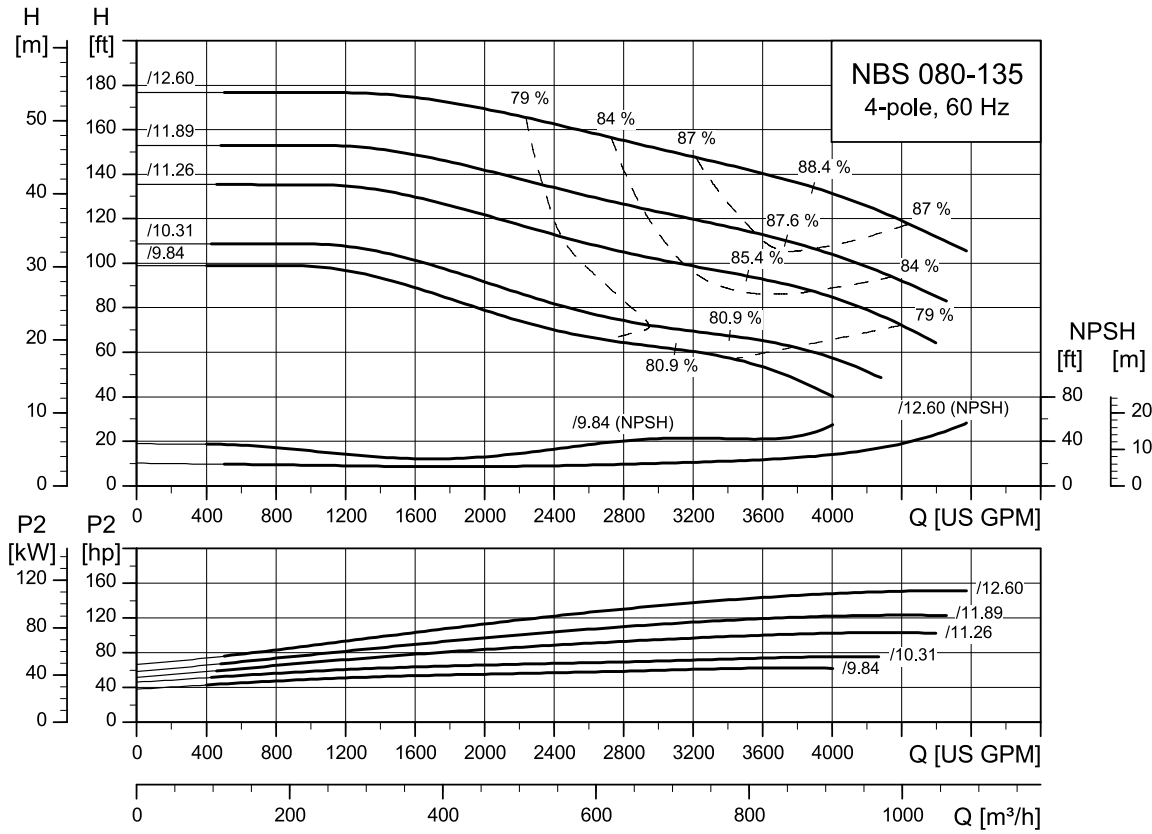

TM077535

**NBS 080-150**

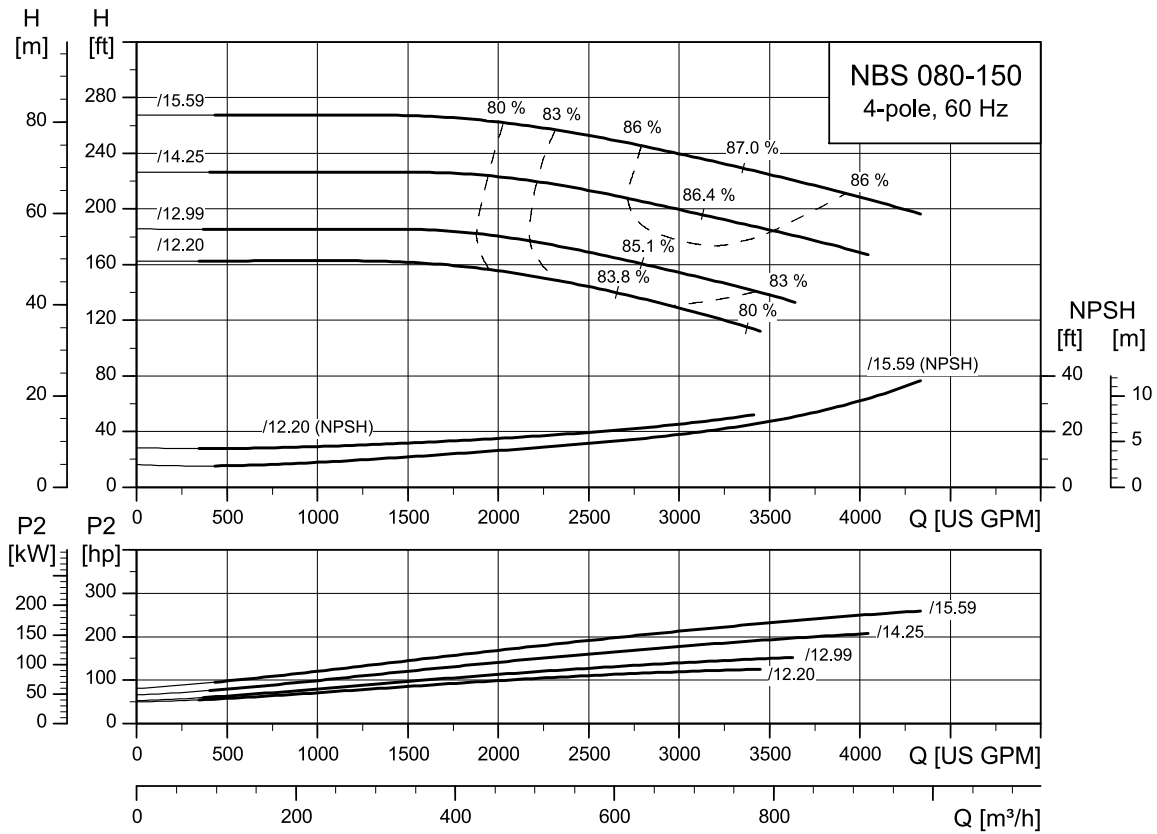

TM077312

**NBS 100-150**

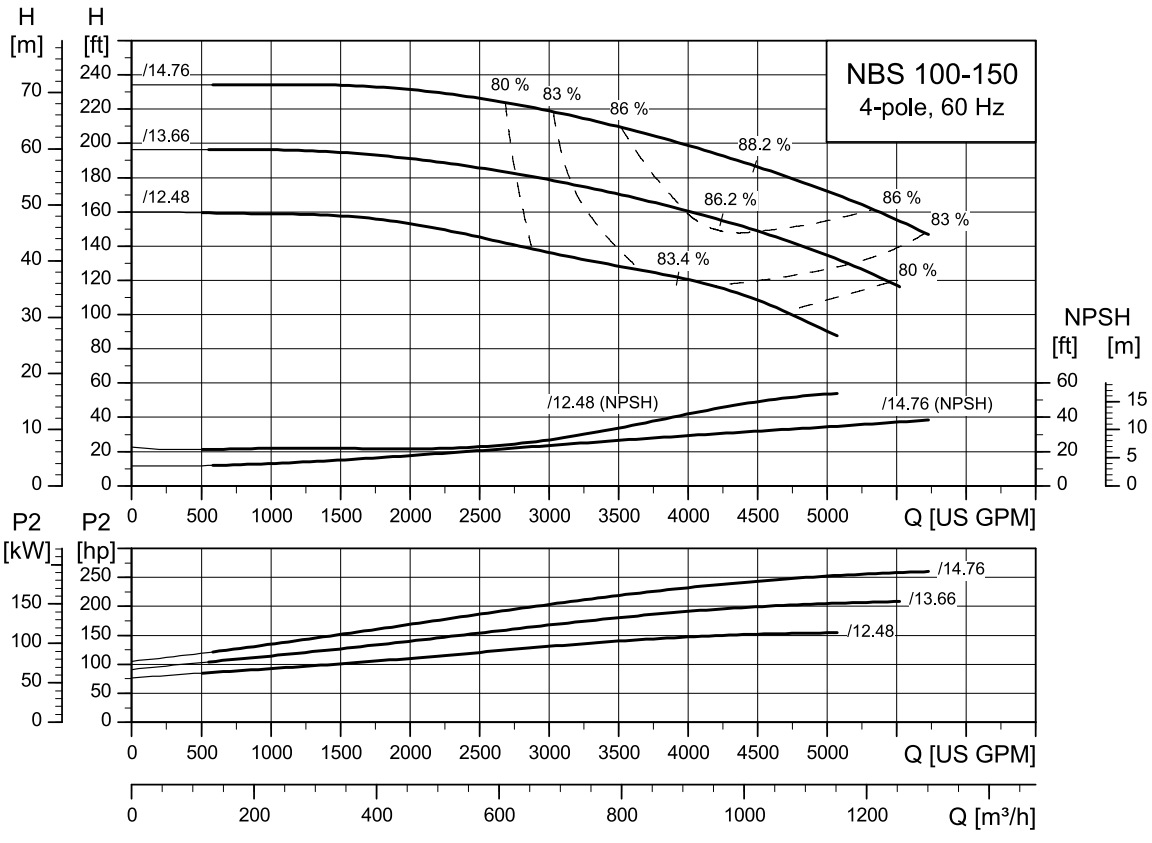

TM07537



### 6-pole

#### NBS 025-095

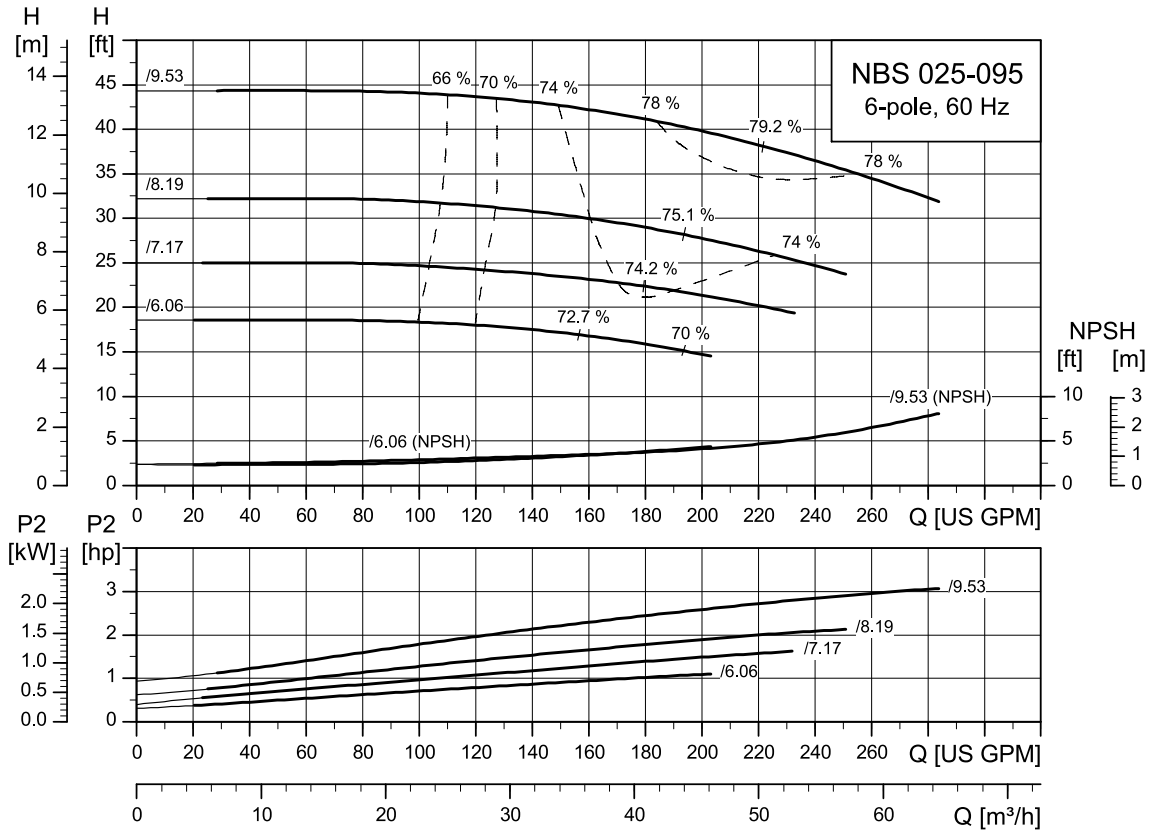

TM077314

#### NBS 025-110

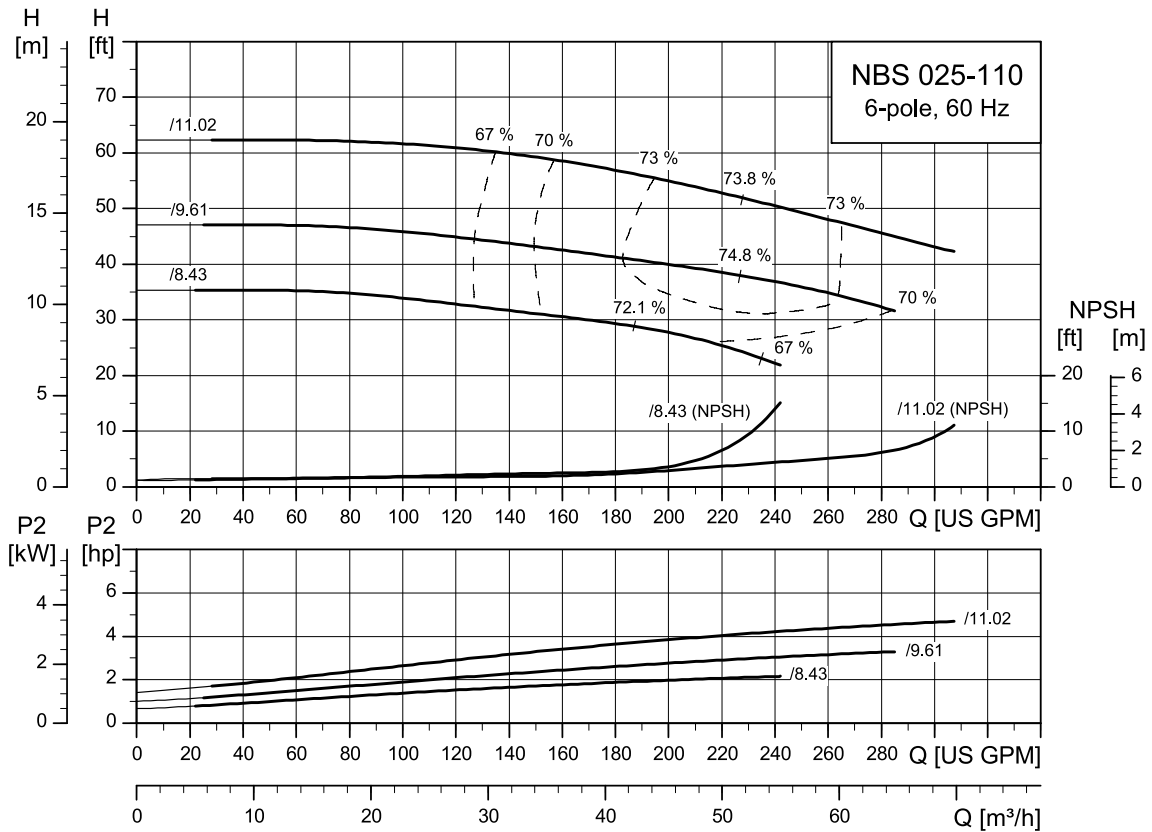

TM077520

**NBS 030-095**

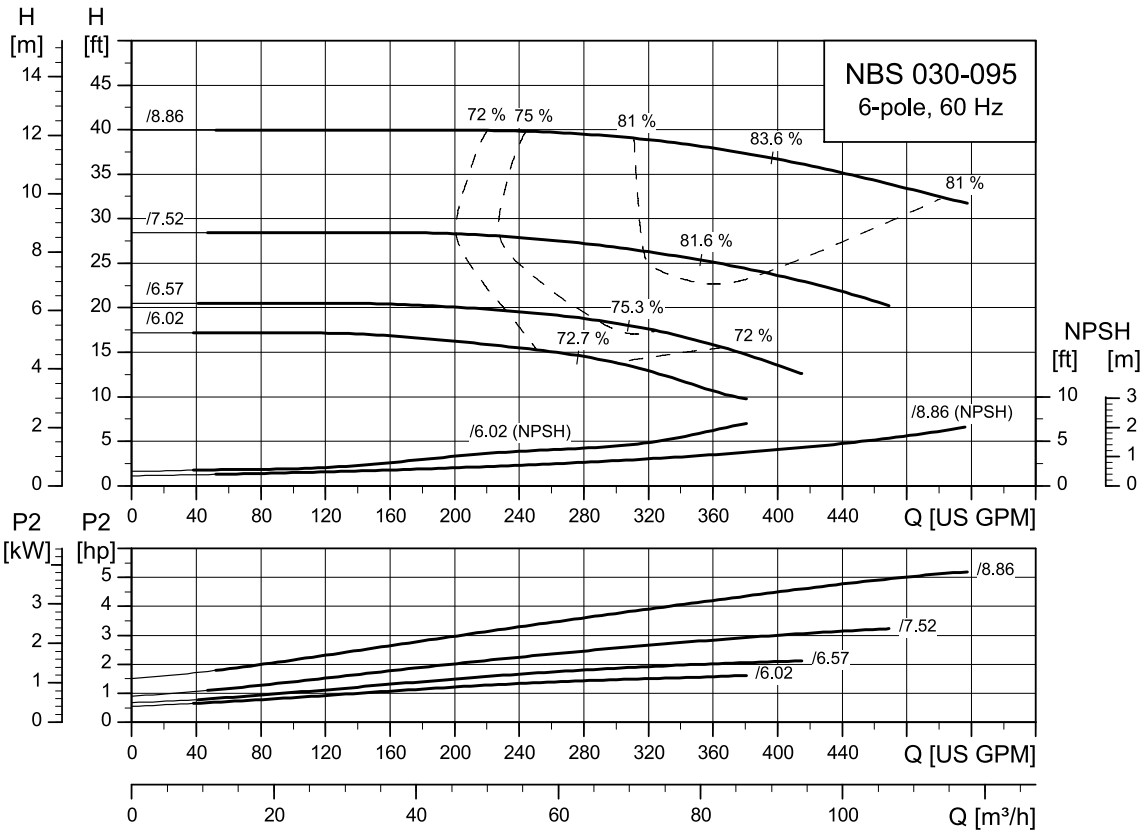

TM077525

**NBS 030-110**

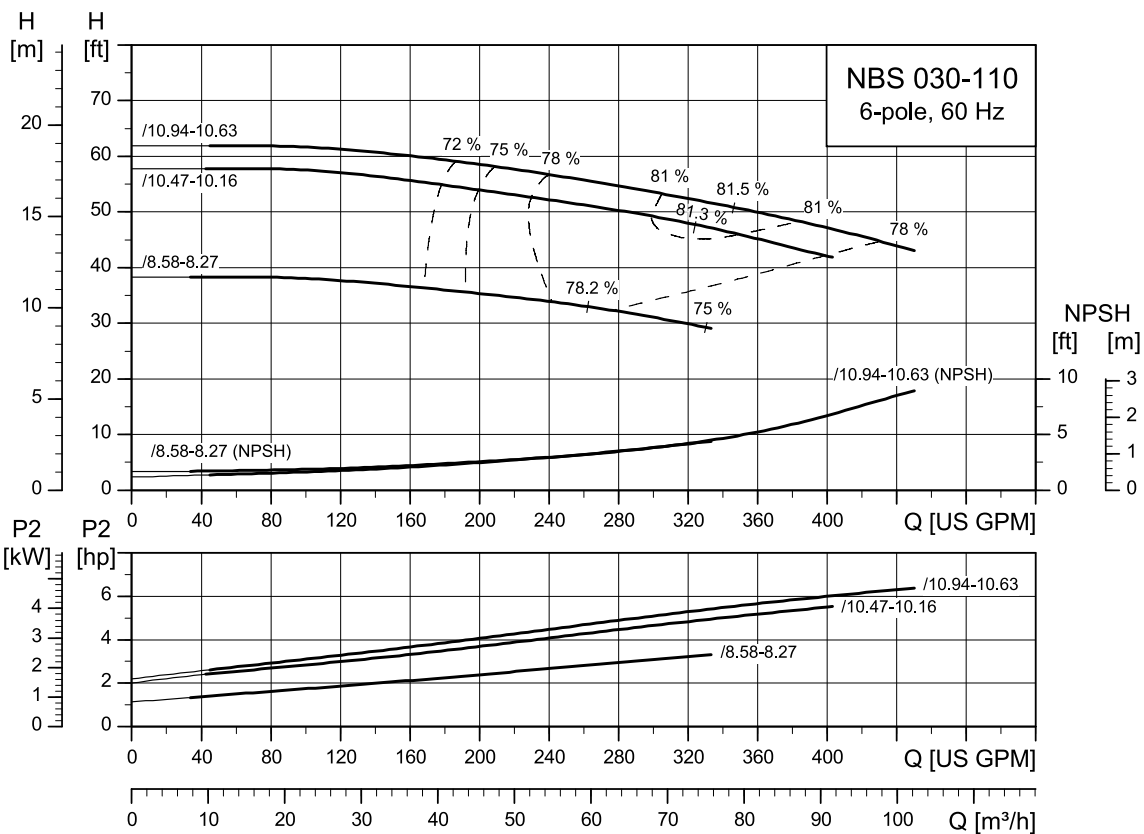

TM077315

**NBS 030-135**

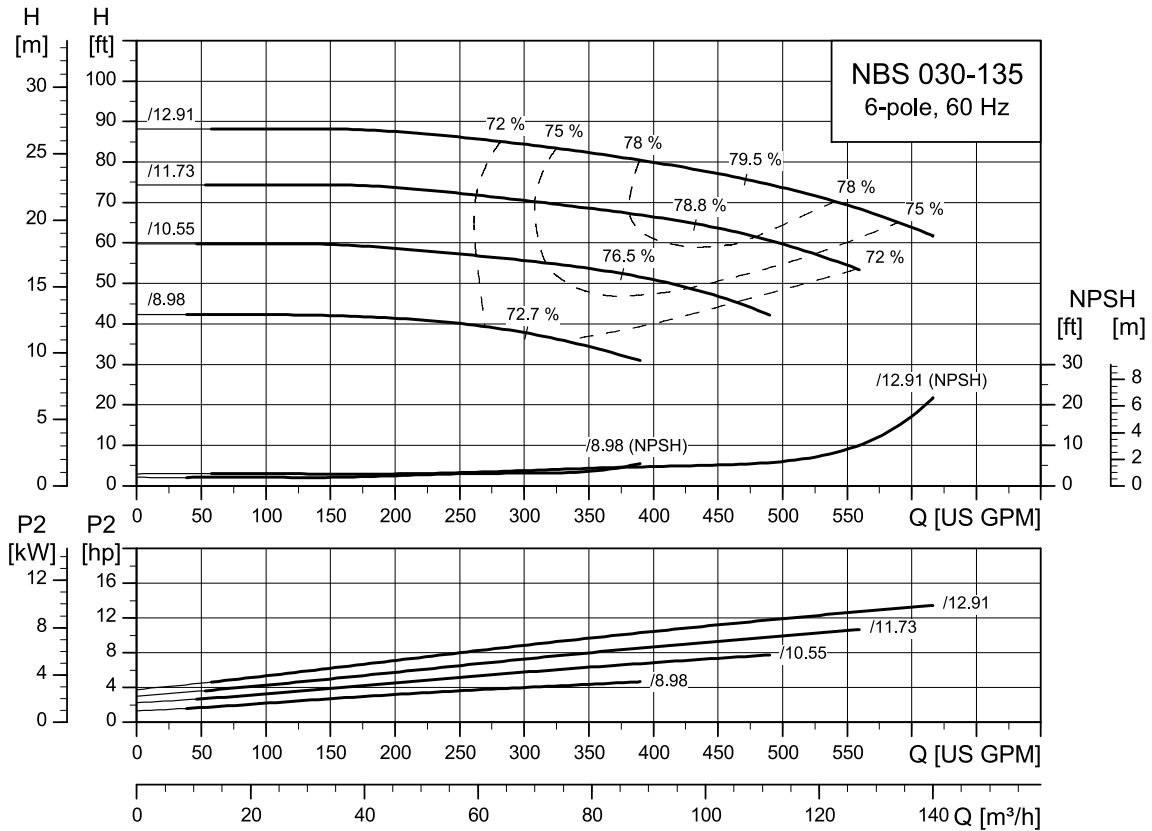

TM077814

**NBS 040-070**

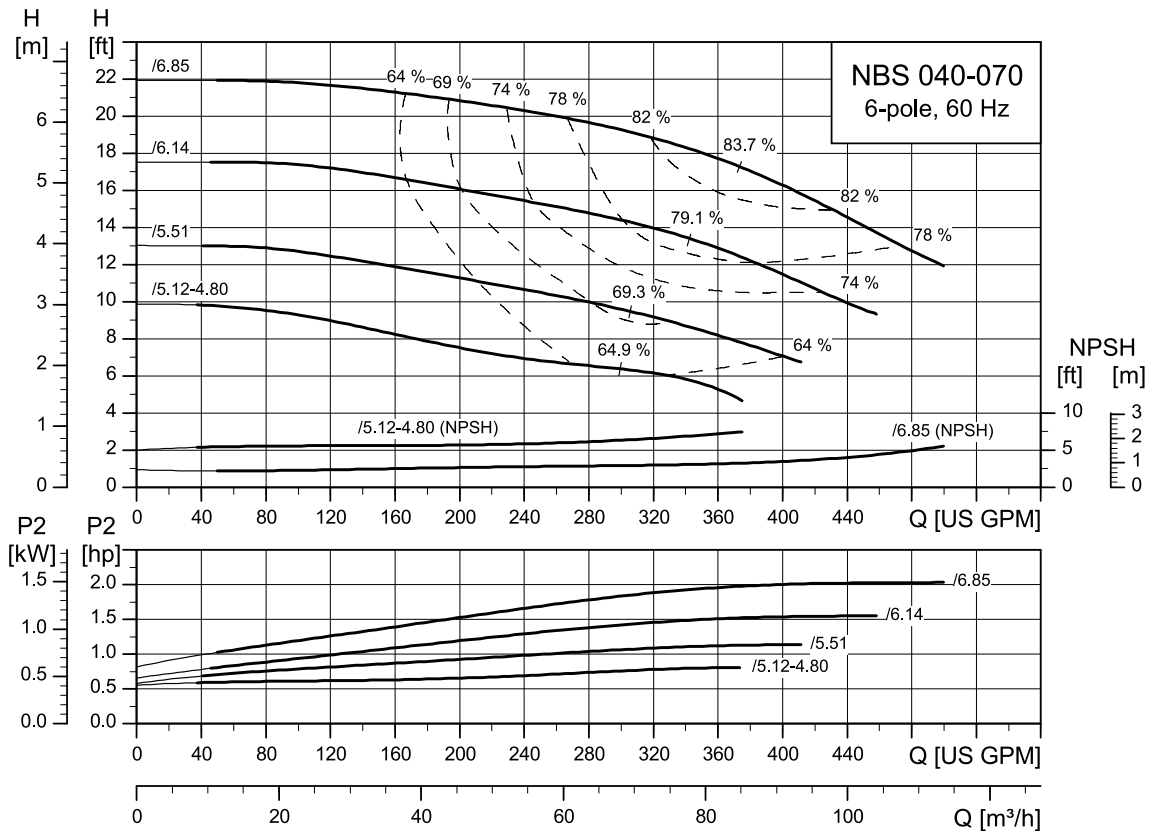

TM077528

**NBS 040-095**

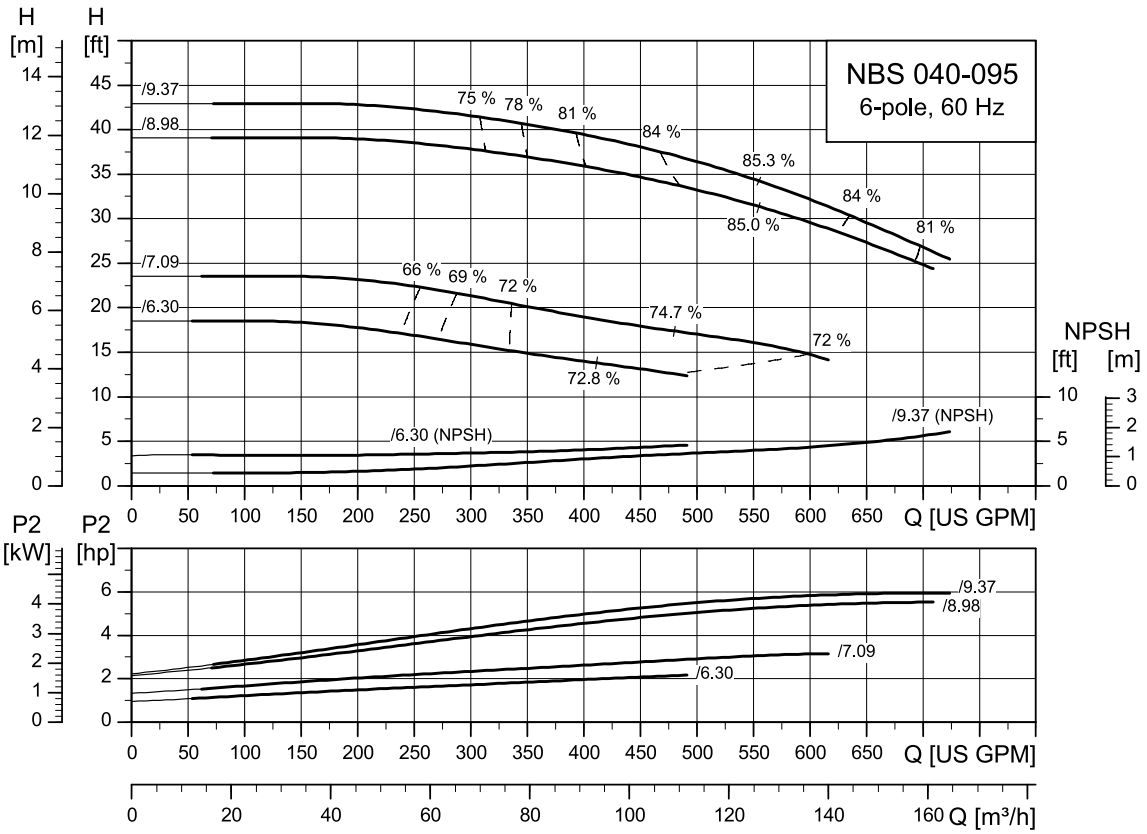

TM077316

**NBS 040-110**

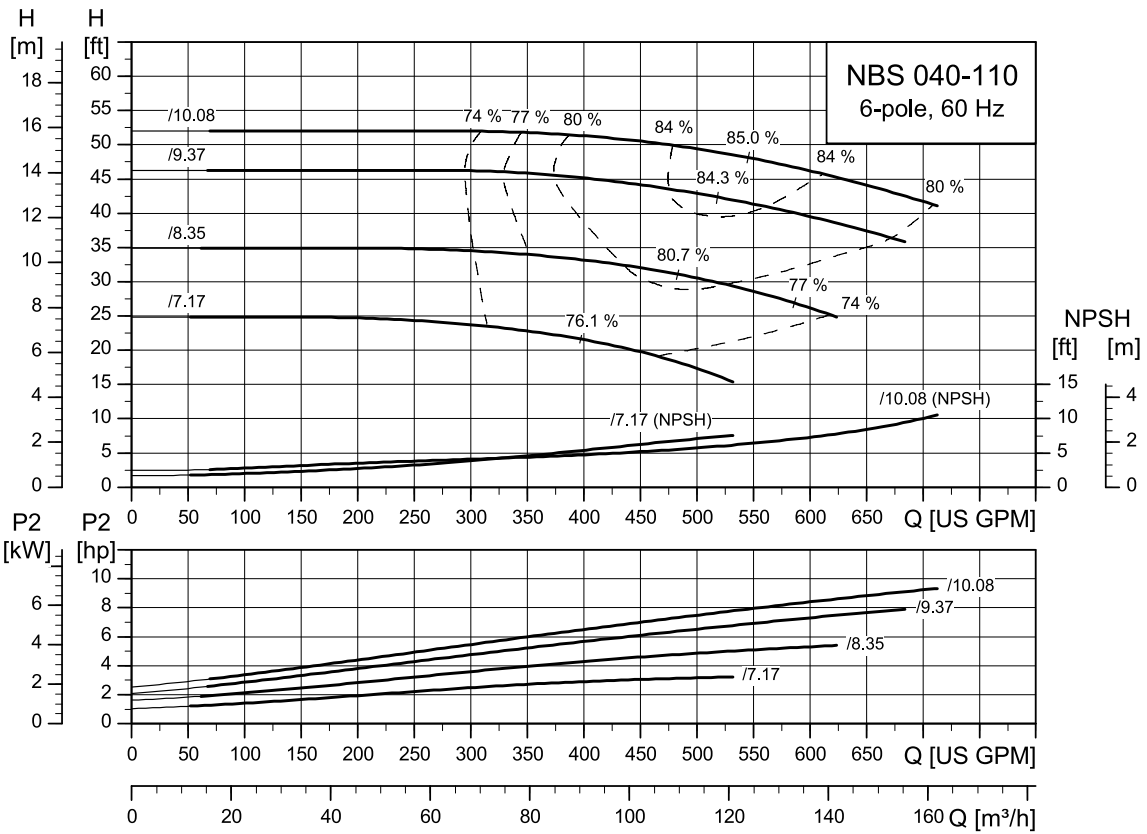

TM077816

**NBS 040-135**

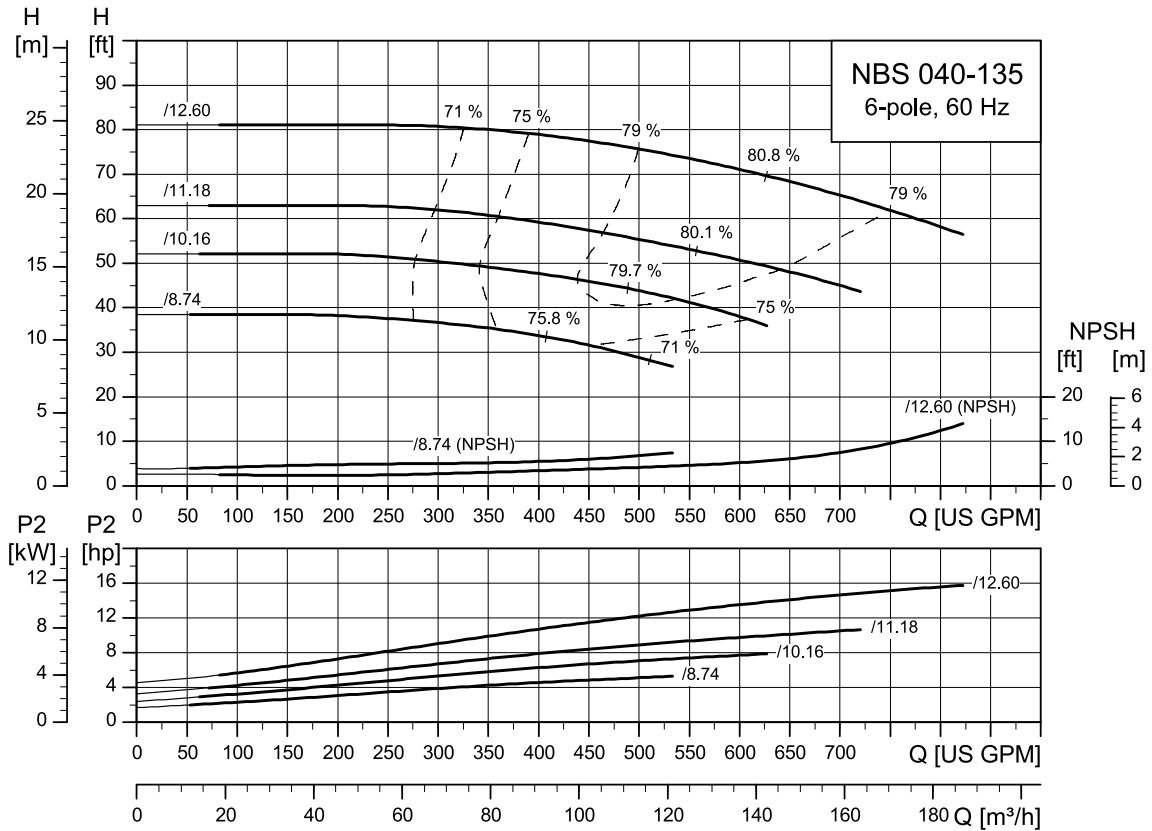

TM077530

**NBS 040-150**

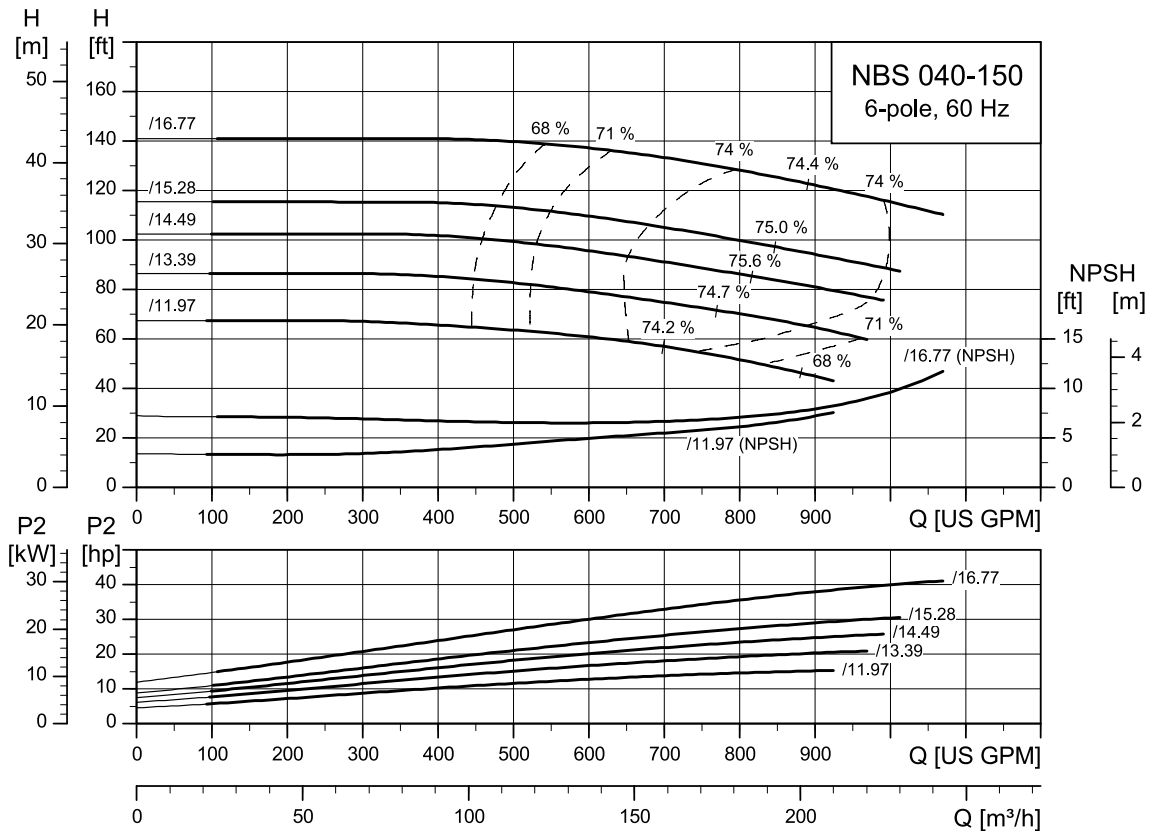

TM077322

**NBS 050-070**

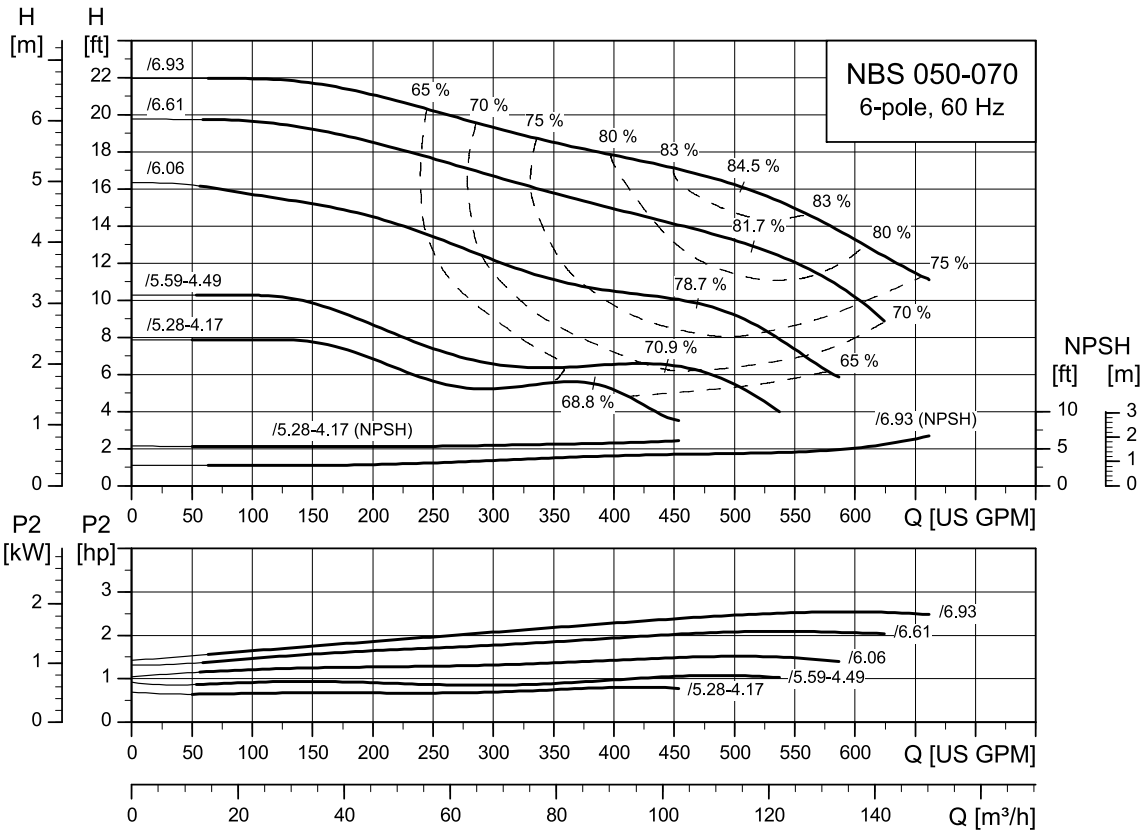

TM077819

**NBS 050-095**

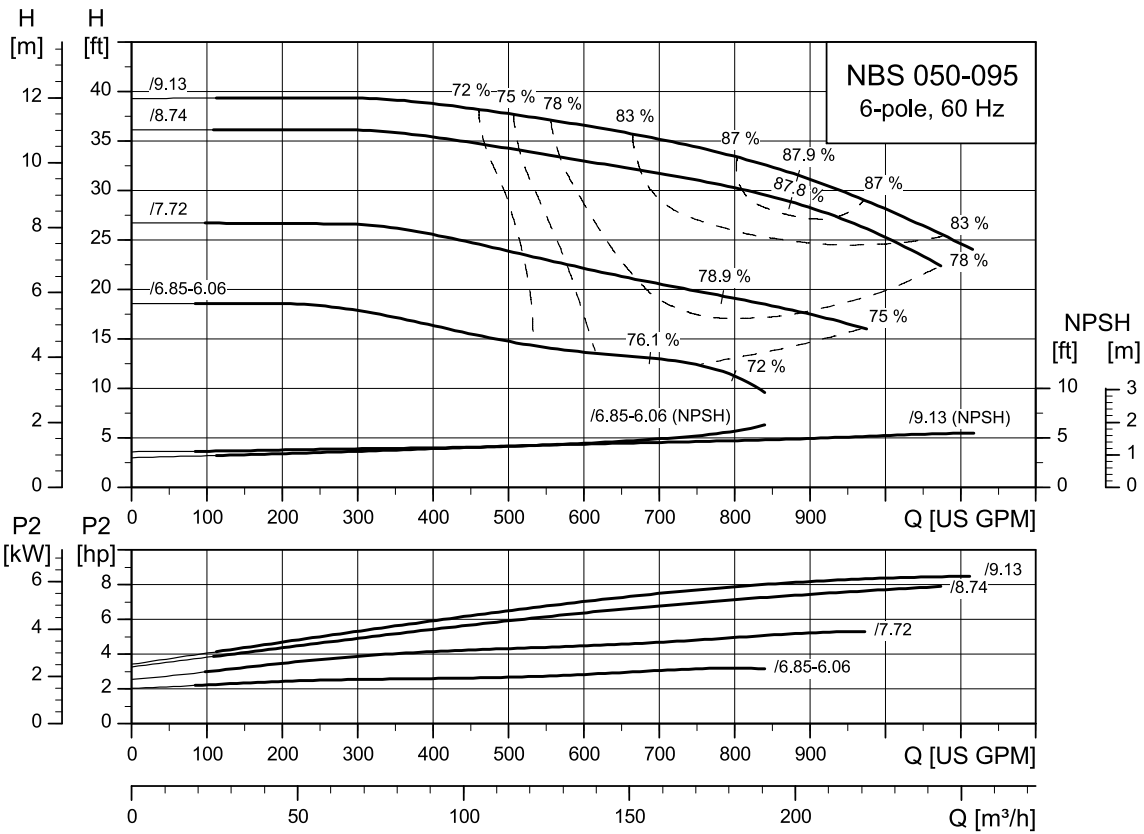

TM077317

**NBS 050-110**

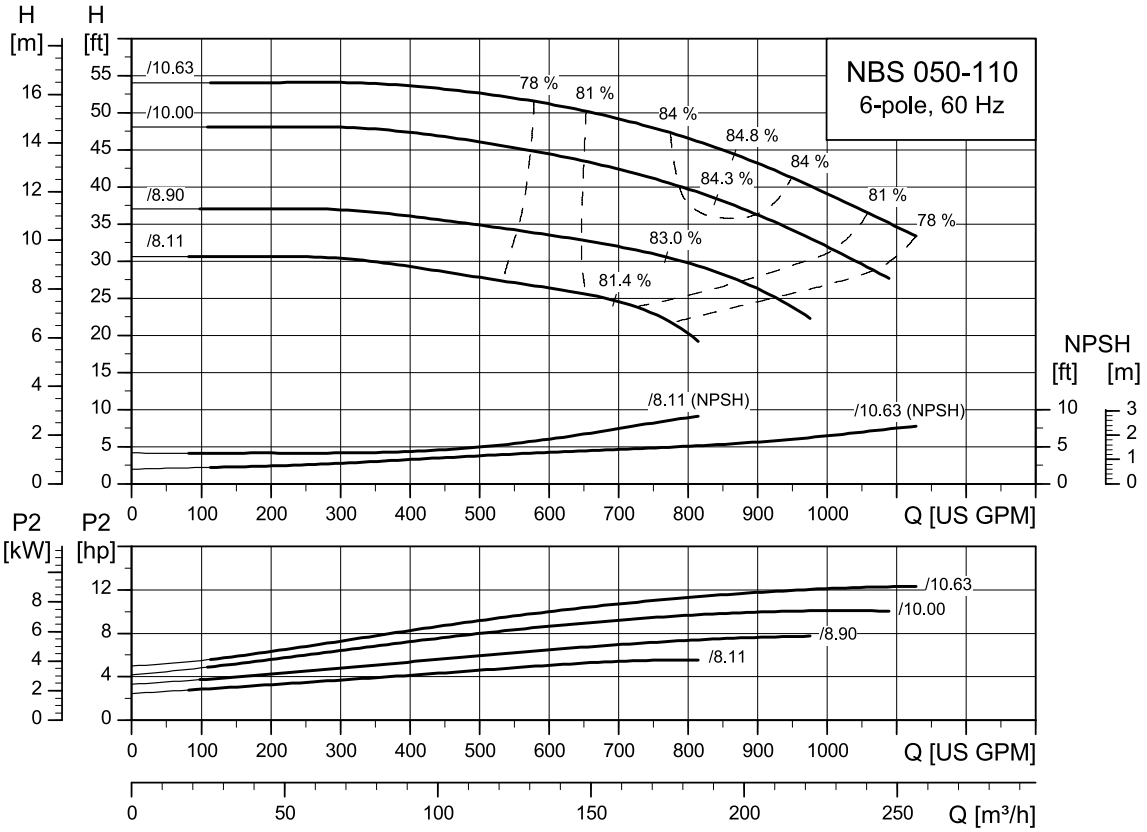

TM077319

**NBS 050-135**

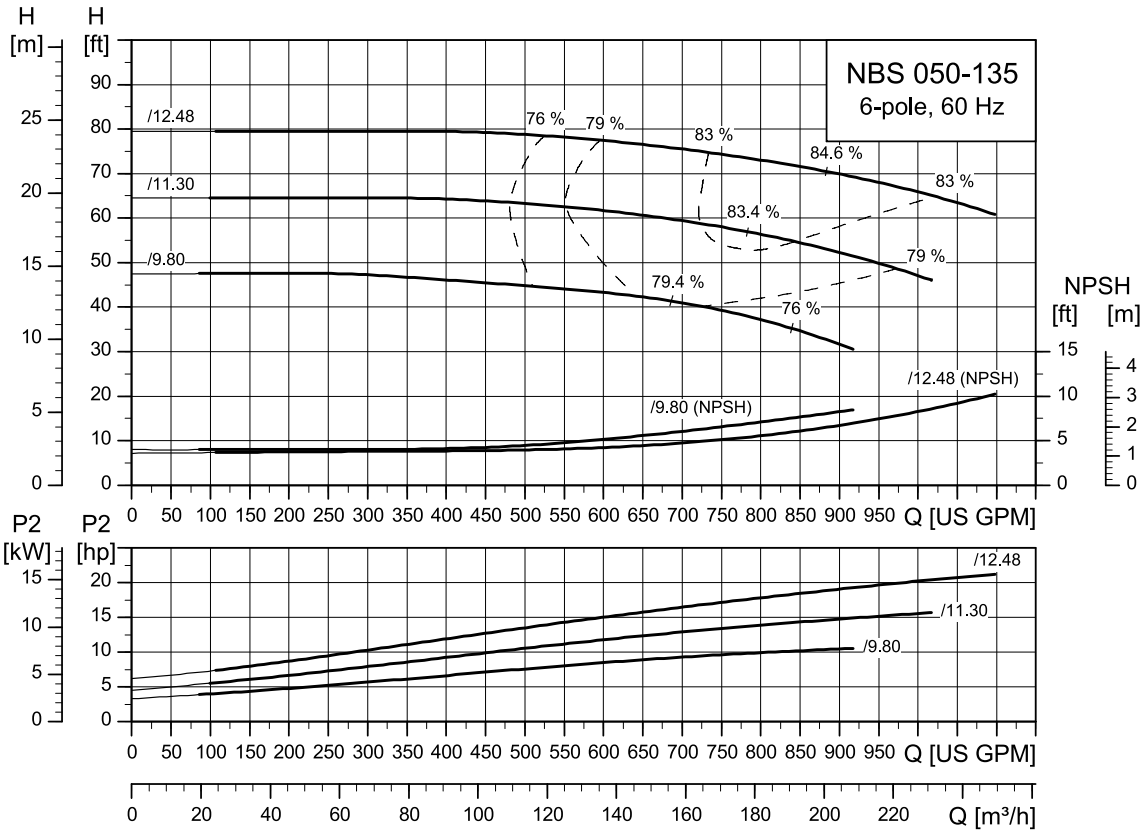

TM077621

**NBS 050-150**

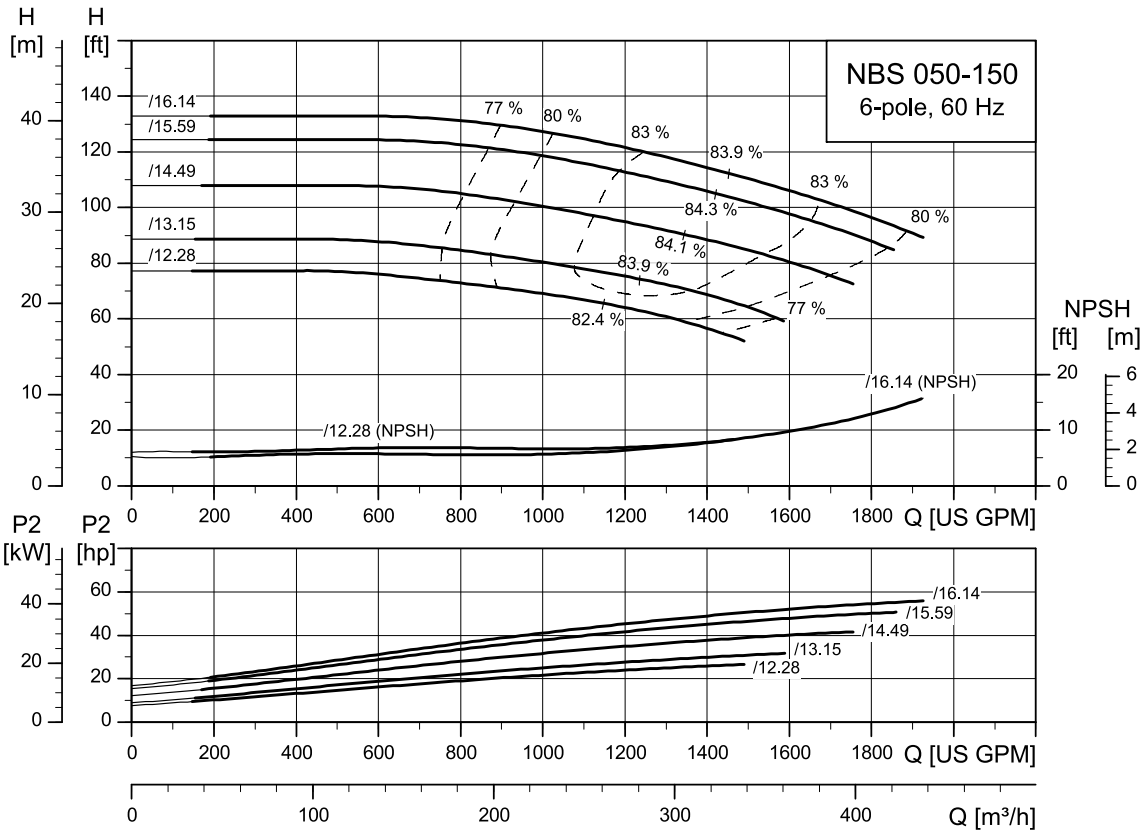

TM07532

**NBS 060-095**

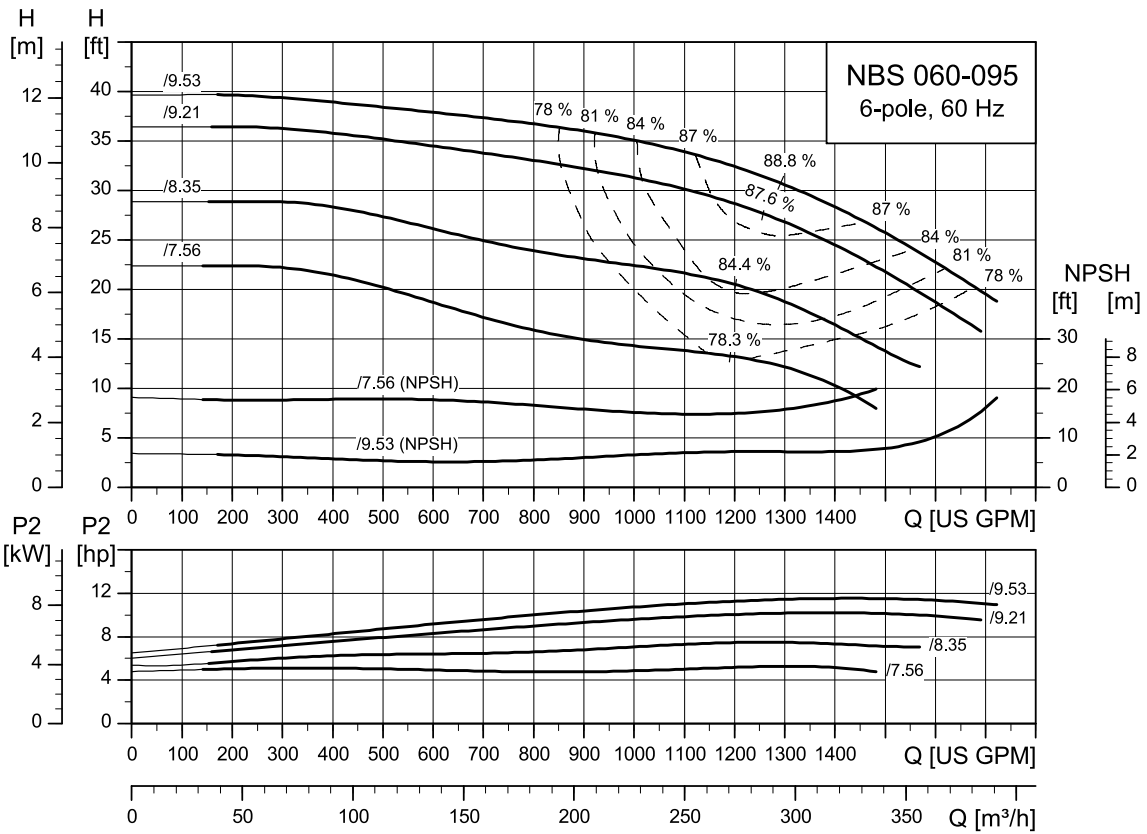

TM07534



**NBS 060-110**

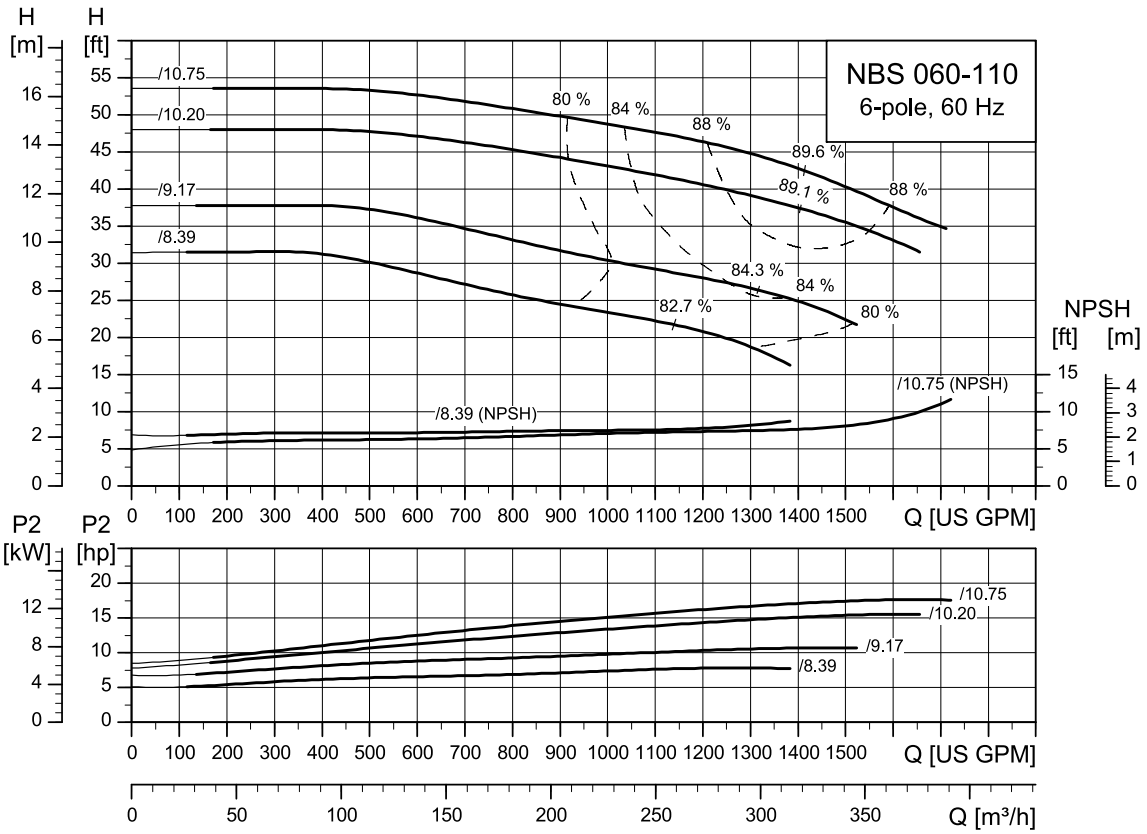

TM077320

**NBS 060-135**

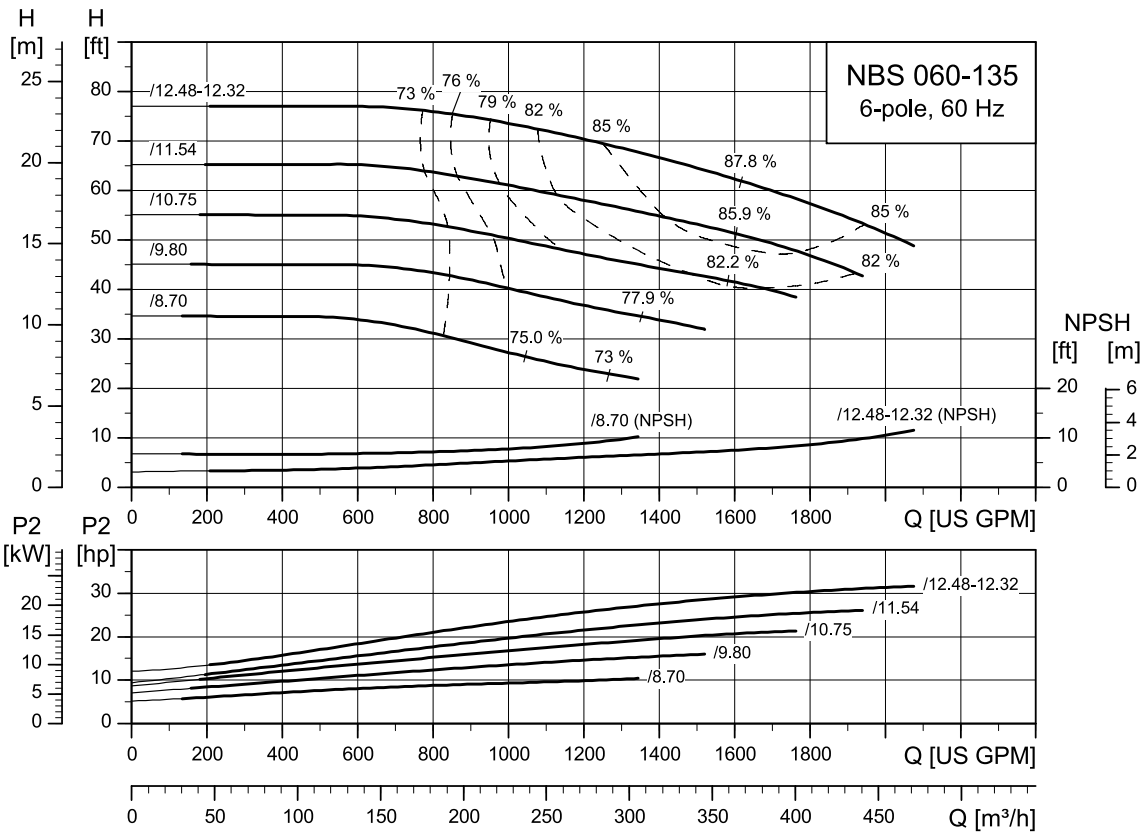

TM077318

**NBS 060-150**

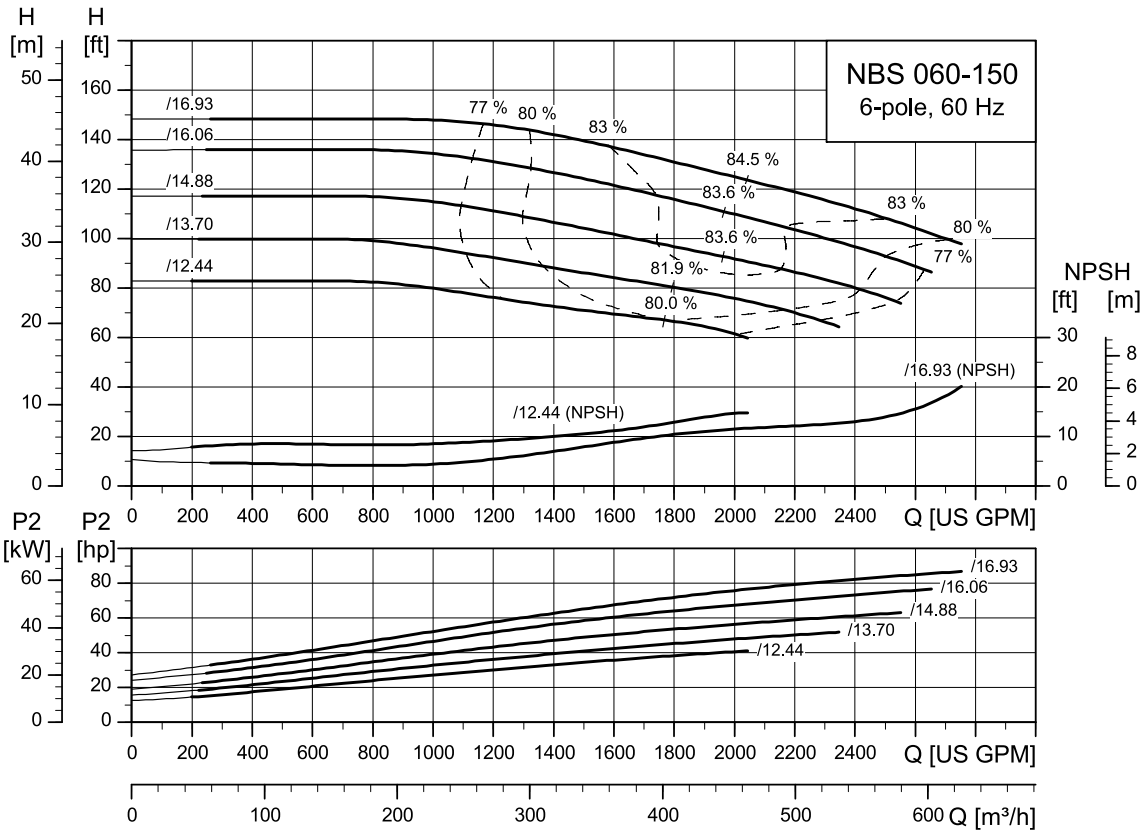

TM07823

**NBS 080-135**

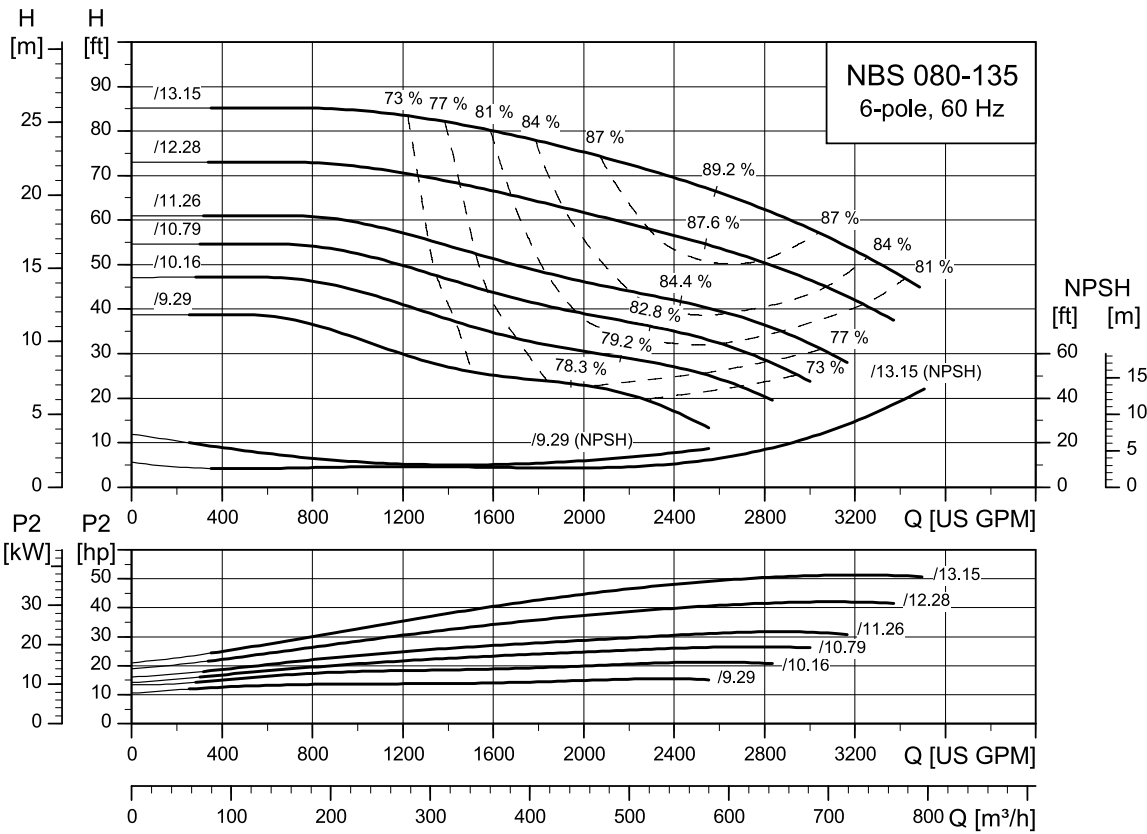

TM07536

**NBS 080-150**

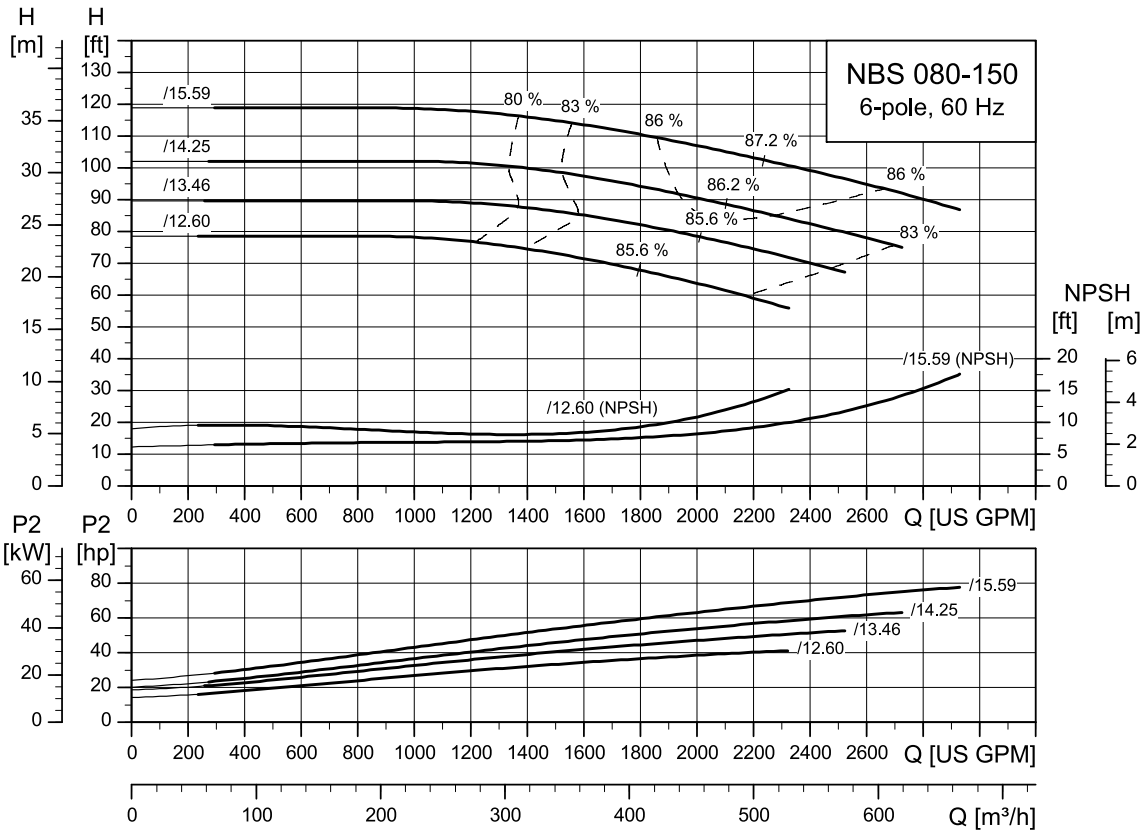

TM077321

**NBS 100-150**

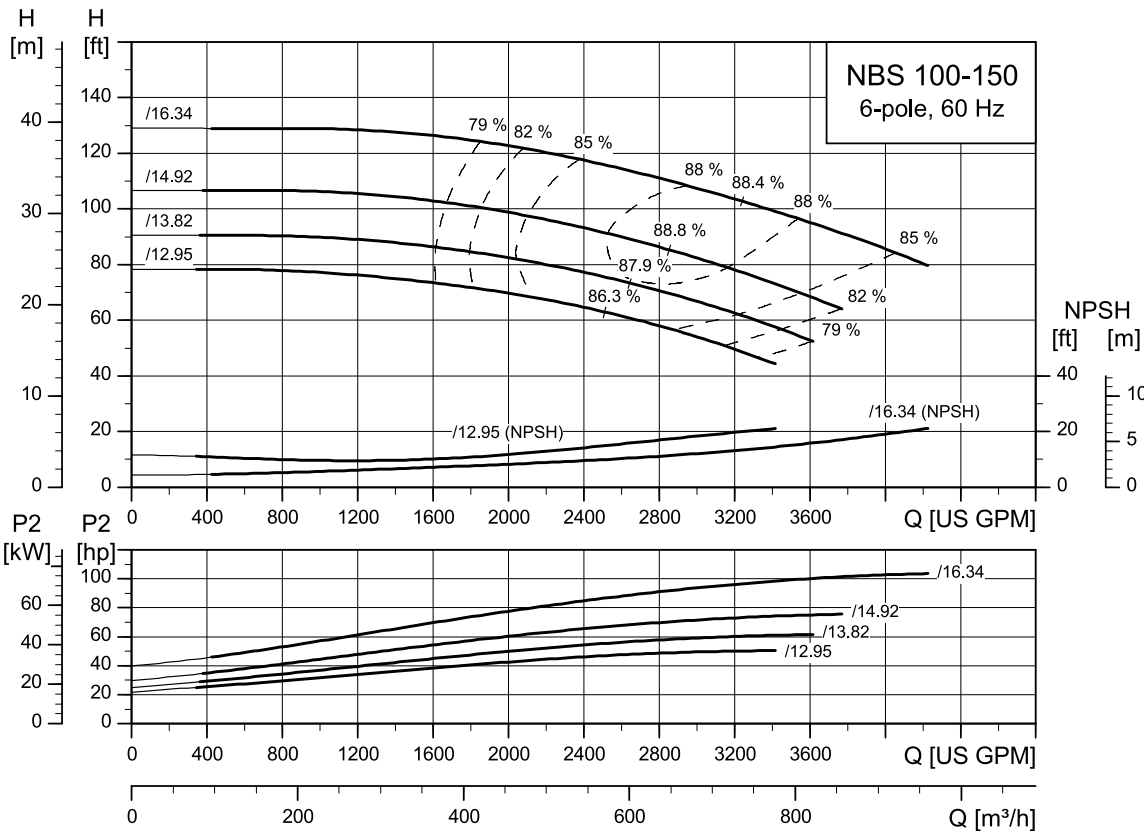

TM077538

# 16. Dimensional drawings and technical data

## Dimensional drawings, NBSE

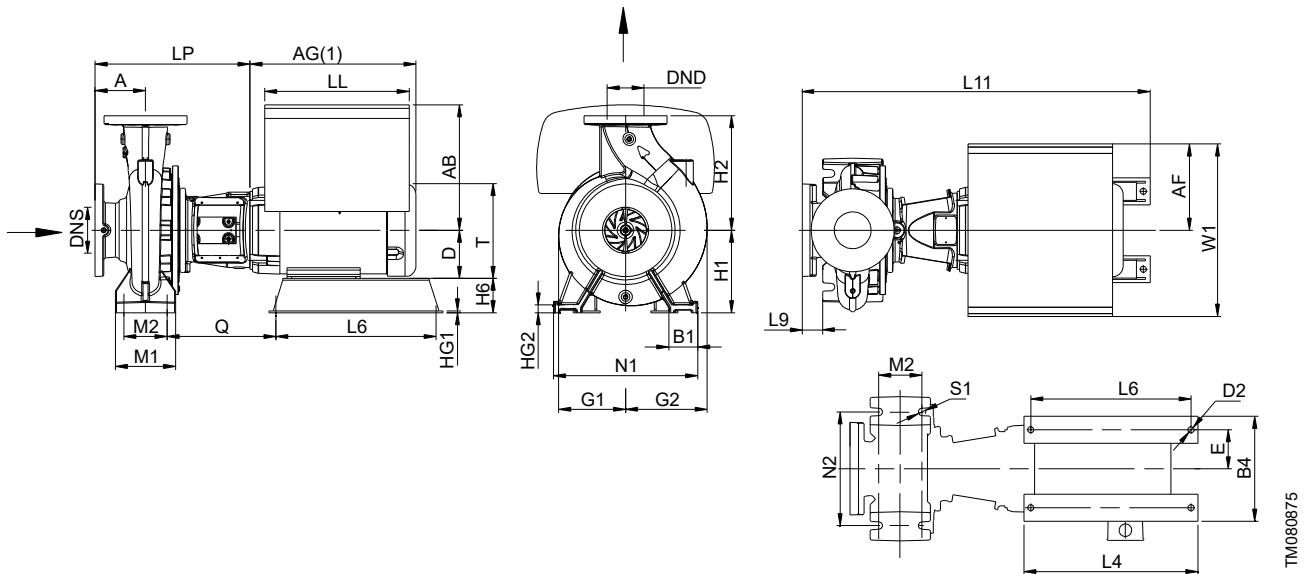

TM080875

Mounting design B, center outlet, motor with support rails

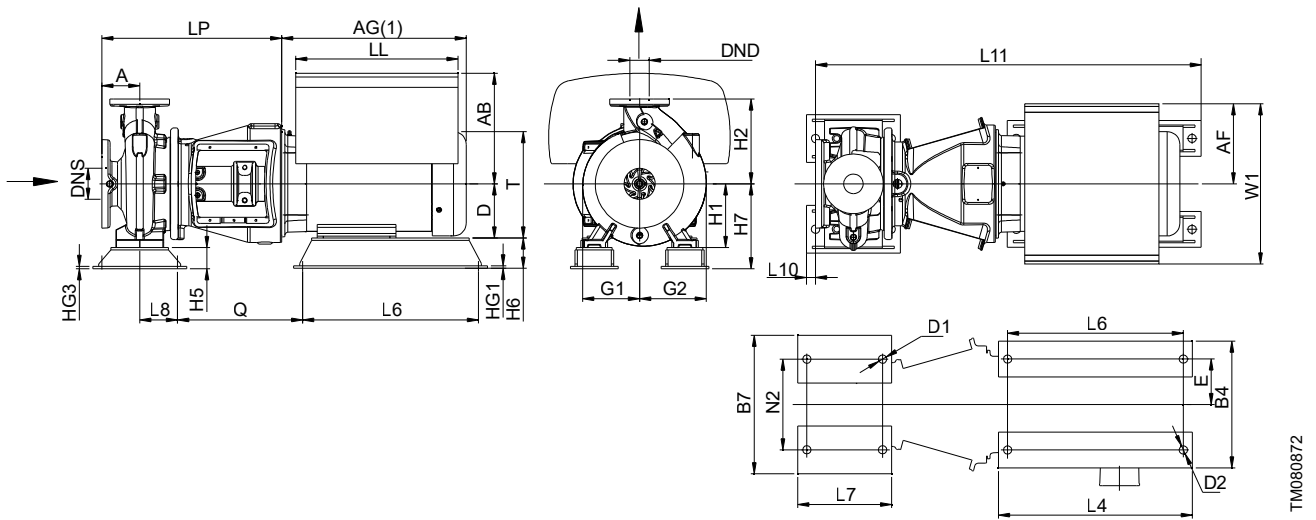

TM080872

Mounting design C, center outlet, pump and motor with support rails

## Dimensions for NBSE pumps (460 V)

Dimensions in inch.

		Dimensions for pumps with TEFC motor and support rails [inch]																				
Pump size	Pole	Actual impeller size [inch]	MLE motor							Support rail under pump					Support rail under motor							
			LP	Q	D	E	T	AB	AG	L7	L8	B7	H5	H7	HG3	L4	L6	B4	H6	HG1		
012-070	3	4.69	14.64	12.47	4.5	3.75	8.69	6.22	10.84	7.75	3.13	11.42	1.75	7	0.2	13.75	12.25	10.45	2.5	0.2		
		5	5.00	14.64	12.47	4.5	3.75	8.69	7.91	13.29	7.75	3.13	11.42	1.75	7	0.2	13.75	12.25	10.45	2.5	0.2	
	2	7.5	5.47	14.64	16.52	5.25	4.25	10.25	7.91	14.64	7.75	3.13	11.42	1.75	7	0.2	16.66	15.16	11.45	1.8	0.2	
		7.5	6.10	14.64	16.52	5.25	4.25	10.25	7.91	14.64	7.75	3.13	11.42	1.75	7	0.2	16.66	15.16	11.45	1.8	0.2	
	4	10	6.97	14.64	16.52	5.25	4.25	10.25	9.33	15.58	7.75	3.13	11.42	1.75	7	0.2	16.66	15.16	11.45	1.8	0.2	
		15	6.65	14.64	16.34	6.25	5	12.88	9.33	15.58	7.75	3.13	11.42	1.75	7	0.2	20.25	18.75	11.97	0.8	0.38	
	015-070	2	15	6.97	14.64	16.34	6.25	5	12.88	9.33	15.58	7.75	3.13	11.42	1.75	7	0.2	20.25	18.75	11.97	0.8	0.38
			1.5	6.97	14.64	12.47	4.5	3.75	8.69	6.22	10.84	7.75	3.13	11.42	1.75	7	0.2	13.75	12.25	10.45	2.5	0.2
		4	2	6.97	14.64	12.47	4.5	3.75	8.69	6.22	10.84	7.75	3.13	11.42	1.75	7	0.2	13.75	12.25	10.45	2.5	0.2
			5	4.49	14.64	12.47	4.5	3.75	8.69	7.91	13.29	7.75	3.13	11.42	1.75	7	0.2	13.75	12.25	10.45	2.5	0.2
2		7.5	5.04	14.64	16.52	5.25	4.25	10.25	7.91	14.64	7.75	3.13	11.42	1.75	7	0.2	16.66	15.16	11.45	1.8	0.2	
		10	6.73	14.64	16.52	5.25	4.25	10.25	9.33	15.58	7.75	3.13	11.42	1.75	7	0.2	16.66	15.16	11.45	1.8	0.2	
4		15	6.93	14.64	16.34	6.25	5	12.88	9.33	15.58	7.75	3.13	11.42	1.75	7	0.2	20.25	18.75	11.97	0.8	0.38	
		1.5	6.54	14.64	12.47	4.5	3.75	8.69	6.22	10.84	7.75	3.13	11.42	1.75	7	0.2	13.75	12.25	10.45	2.5	0.2	
015-090		2	2	6.93	14.64	12.47	4.5	3.75	8.69	6.22	10.84	7.75	3.13	11.42	1.75	7	0.2	13.75	12.25	10.45	2.5	0.2
			3	6.93	14.64	12.47	4.5	3.75	8.69	7.91	13.29	7.75	3.13	11.42	1.75	7	0.2	13.75	12.25	10.45	2.5	0.2
	4	5	6.93	14.64	12.47	4.5	3.75	8.69	7.91	13.29	7.75	3.13	11.42	1.75	7	0.2	13.75	12.25	10.45	2.5	0.2	
		15	7.80	17.13	18.21	6.25	5	12.88	9.33	15.58	8.75	3.63	12.8	1	8	0.5	20	18.5	12.95	1.8	0.2	
	2	20	8.82	17.13	17.71	6.25	5	12.88	11.93	19.24	8.75	3.63	12.8	1	8	0.5	20	18.5	12.95	1.8	0.2	
		25	8.82	15.44	16.27	7	5.5	14.63	11.93	20.23	8.75	3.63	12.8	1	8	0.5	22.25	20.75	13.95	1	0.5	
	4	30	9.84	15.44	16.27	7	5.5	14.63	11.93	20.23	8.75	3.63	12.8	1	8	0.5	22.25	20.75	13.95	1	0.5	
		1.5	7.24	15.52	13.74	4.5	3.75	8.69	6.22	10.84	-	-	-	-	-	-	14.66	13.16	10.45	2.5	0.2	
	015-095	2	2	8.11	15.52	13.74	4.5	3.75	8.69	6.22	10.84	-	-	-	-	-	-	14.66	13.16	10.45	2.5	0.2
			3	9.84	15.52	13.74	4.5	3.75	8.69	7.91	13.29	-	-	-	-	-	-	14.66	13.16	10.45	2.5	0.2
4		5	9.84	15.52	13.74	4.5	3.75	8.69	7.91	13.29	-	-	-	-	-	-	14.66	13.16	10.45	2.5	0.2	
		7.5	9.84	15.52	17.79	5.25	4.25	10.25	9.33	15.58	-	-	-	-	-	-	16.66	15.16	11.45	1.8	0.2	
2		10	9.84	15.52	17.79	5.25	4.25	10.25	9.33	15.58	-	-	-	-	-	-	16.66	15.16	11.45	1.8	0.2	
		15	7.01	17.13	18.21	6.25	5	12.88	9.33	15.58	8.75	3.63	12.8	1	8	0.5	20	18.5	12.95	1.8	0.2	
4		20	7.87	17.13	17.71	6.25	5	12.88	11.93	19.24	8.75	3.63	12.8	1	8	0.5	20	18.5	12.95	1.8	0.2	
		25	7.87	15.44	16.27	7	5.5	14.63	11.93	20.23	8.75	3.63	12.8	1	8	0.5	22.25	20.75	13.95	1	0.5	
020-095		2	30	8.82	15.44	16.27	7	5.5	14.63	11.93	20.23	8.75	3.63	12.8	1	8	0.5	22.25	20.75	13.95	1	0.5
			2	7.32	15.52	13.74	4.5	3.75	8.69	6.22	10.84	-	-	-	-	-	-	14.66	13.16	10.45	2.5	0.2
	4	3	8.35	15.52	13.74	4.5	3.75	8.69	7.91	13.29	-	-	-	-	-	-	14.66	13.16	10.45	2.5	0.2	
		5	8.82	15.52	13.74	4.5	3.75	8.69	7.91	13.29	-	-	-	-	-	-	14.66	13.16	10.45	2.5	0.2	
	2	7.5	9.84	15.52	17.79	5.25	4.25	10.25	9.33	15.58	-	-	-	-	-	-	16.66	15.16	11.45	1.8	0.2	
		10	9.84	15.52	17.79	5.25	4.25	10.25	9.33	15.58	-	-	-	-	-	-	16.66	15.16	11.45	1.8	0.2	
	4	15	6.26	17.54	18.62	6.25	5	12.88	9.33	15.58	8.75	3.63	12.8	1	8	0.5	20	18.5	12.95	1.8	0.2	
		20	7.17	17.54	18.12	6.25	5	12.88	11.93	19.24	8.75	3.63	12.8	1	8	0.5	20	18.5	12.95	1.8	0.2	
	020-095	2	25	7.60	15.85	16.68	7	5.5	14.63	11.93	20.23	8.75	3.63	12.8	1	8	0.5	22.25	20.75	13.95	1	0.5
			30	8.03	15.85	16.68	7	5.5	14.63	11.93	20.23	8.75	3.63	12.8	1	8	0.5	22.25	20.75	13.95	1	0.5
4		2	5.83	15.52	13.74	4.5	3.75	8.69	6.22	10.84	-	-	-	-	-	-	14.66	13.16	10.45	2.5	0.2	
		3	7.24	15.52	13.74	4.5	3.75	8.69	7.91	13.29	-	-	-	-	-	-	14.66	13.16	10.45	2.5	0.2	
2		5	9.45	15.52	13.74	4.5	3.75	8.69	7.91	13.29	-	-	-	-	-	-	14.66	13.16	10.45	2.5	0.2	
		7.5	9.45	15.52	17.79	5.25	4.25	10.25	9.33	15.58	-	-	-	-	-	-	16.66	15.16	11.45	1.8	0.2	
4	10	9.45	15.52	17.79	5.25	4.25	10.25	9.33	15.58	-	-	-	-	-	-	16.66	15.16	11.45	1.8	0.2		

Dimensions for pumps with TEFC motor and support rails [inch]																					
Pump size	Pole	P2 [hp]	Actual impeller size [inch]	MLE motor						Support rail under pump						Support rail under motor					
				LP	Q	D	E	T	AB	AG	L7	L8	B7	H5	H7	HG3	L4	L6	B4	H6	HG1
020-110	4	5	8.98	15.52	13.74	4.5	3.75	8.69	7.91	13.29	-	-	-	-	-	-	14.66	13.16	10.45	2.5	0.2
		7.5	9.92	15.52	17.79	5.25	4.25	10.25	9.33	15.58	-	-	-	-	-	-	16.66	15.16	11.45	1.8	0.2
		10	9.92	15.52	17.79	5.25	4.25	10.25	9.33	15.58	-	-	-	-	-	-	16.66	15.16	11.45	1.8	0.2
		15	10.31	15.52	17.11	6.25	5	12.88	11.93	19.24	-	-	-	-	-	-	20.25	18.75	11.97	0.8	0.38
		20	9.92	15.52	17.11	6.25	5	12.88	11.93	19.24	-	-	-	-	-	-	20.25	18.75	11.97	0.8	0.38
020-130	4	7.5	10.16	17.56	18.83	5.25	4.25	10.25	9.33	15.58	-	-	-	-	-	-	16.66	15.16	11.45	3.8	0.2
		10	11.42	17.56	18.83	5.25	4.25	10.25	9.33	15.58	-	-	-	-	-	-	16.66	15.16	11.45	3.8	0.2
		15	12.52	17.56	18.9	6.25	5	12.88	11.93	19.24	-	-	-	-	-	-	20.5	19	12.95	2.8	0.2
		20	13.31	17.56	18.9	6.25	5	12.88	11.93	19.24	-	-	-	-	-	-	20.5	19	12.95	2.8	0.2
		25	13.31	18.94	21.16	7	5.5	14.63	11.93	21.96	-	-	-	-	-	-	21.75	20.25	15.17	2	0.31
		30	13.31	18.94	21.16	7	5.5	14.63	11.93	21.96	-	-	-	-	-	-	21.75	20.25	15.17	2	0.31
025-070	2	5	4.57	15.52	11.98	4.5	3.75	8.69	7.91	13.29	8.75	3.63	11.3	0.75	7	0.38	14.66	13.16	10.45	2.5	0.2
		7.5	4.57	15.52	16.03	5.25	4.25	10.25	7.91	14.64	8.75	3.63	11.3	0.75	7	0.38	16.66	15.16	11.45	1.8	0.2
		10	4.96	15.52	16.03	5.25	4.25	10.25	9.33	15.58	8.75	3.63	11.3	0.75	7	0.38	16.66	15.16	11.45	1.8	0.2
		15	6.65	15.52	15.85	6.25	5	12.88	9.33	15.58	8.75	3.63	11.3	0.75	7	0.38	20.25	18.75	11.97	0.8	0.38
		20	6.77	15.52	15.35	6.25	5	12.88	11.93	19.24	8.75	3.63	11.3	0.75	7	0.38	20.25	18.75	11.97	0.8	0.38
		25	6.77	15.44	16.15	7	5.5	14.63	11.93	20.23	9	3.75	12.28	1.75	8	0.2	22.25	20.75	13.95	1	0.5
		30	6.77	15.44	16.15	7	5.5	14.63	11.93	20.23	9	3.75	12.28	1.75	8	0.2	22.25	20.75	13.95	1	0.5
025-095	4	1.5	5.28	15.52	11.98	4.5	3.75	8.69	6.22	10.84	8.75	3.63	11.3	0.75	7	0.38	14.66	13.16	10.45	2.5	0.2
		2	6.54	15.52	11.98	4.5	3.75	8.69	6.22	10.84	8.75	3.63	11.3	0.75	7	0.38	14.66	13.16	10.45	2.5	0.2
		3	6.61	15.52	11.98	4.5	3.75	8.69	7.91	13.29	8.75	3.63	11.3	0.75	7	0.38	14.66	13.16	10.45	2.5	0.2
		5	6.77	15.52	11.98	4.5	3.75	8.69	7.91	13.29	8.75	3.63	11.3	0.75	7	0.38	14.66	13.16	10.45	2.5	0.2
		25	6.57	15.85	18.02	7	5.5	14.63	11.93	20.23	-	-	-	-	-	-	22.25	20.75	13.95	1	0.5
025-110	4	30	7.17	15.85	18.02	7	5.5	14.63	11.93	20.23	-	-	-	-	-	-	22.25	20.75	13.95	1	0.5
		3	5.98	15.52	13.33	4.5	3.75	8.69	7.91	13.29	-	-	-	-	-	-	14.66	13.16	10.45	3.5	0.2
		5	9.13	15.52	13.33	4.5	3.75	8.69	7.91	13.29	-	-	-	-	-	-	14.66	13.16	10.45	3.5	0.2
		7.5	9.53	15.52	17.38	5.25	4.25	10.25	9.33	15.58	-	-	-	-	-	-	16.66	15.16	11.45	2.8	0.2
		10	9.53	15.52	17.38	5.25	4.25	10.25	9.33	15.58	-	-	-	-	-	-	16.66	15.16	11.45	2.8	0.2
030-070	2	7.5	9.45	17.56	18.34	5.25	4.25	10.25	9.33	15.58	-	-	-	-	-	-	16.66	15.16	11.45	2.8	0.2
		10	10.63	17.56	18.34	5.25	4.25	10.25	9.33	15.58	-	-	-	-	-	-	16.66	15.16	11.45	2.8	0.2
		15	11.02	17.56	18.41	6.25	5	12.88	11.93	19.24	-	-	-	-	-	-	20	18.5	12.95	1.8	0.2
		20	11.02	17.56	18.41	6.25	5	12.88	11.93	19.24	-	-	-	-	-	-	20	18.5	12.95	1.8	0.2
		7.5	5.04	15.52	16.03	5.25	4.25	10.25	7.91	14.64	8.75	3.63	11.3	0.75	7	0.38	16.66	15.16	11.45	1.8	0.2
030-095	4	10	5.39	15.52	16.03	5.25	4.25	10.25	9.33	15.58	8.75	3.63	11.3	0.75	7	0.38	16.66	15.16	11.45	1.8	0.2
		15	5.87	15.52	15.85	6.25	5	12.88	9.33	15.58	8.75	3.63	11.3	0.75	7	0.38	20.25	18.75	11.97	0.8	0.38
		20	6.02	15.52	15.35	6.25	5	12.88	11.93	19.24	8.75	3.63	11.3	0.75	7	0.38	20.25	18.75	11.97	0.8	0.38
		25	6.85	15.44	16.15	7	5.5	14.63	11.93	20.23	9	3.75	12.28	1.75	8	0.2	22.25	20.75	13.95	1	0.5
		30	6.85	15.44	16.15	7	5.5	14.63	11.93	20.23	9	3.75	12.28	1.75	8	0.2	22.25	20.75	13.95	1	0.5
030-110	4	1.5	5.20	15.52	11.98	4.5	3.75	8.69	6.22	10.84	8.75	3.63	11.3	0.75	7	0.38	14.66	13.16	10.45	2.5	0.2
		2	5.71	15.52	11.98	4.5	3.75	8.69	6.22	10.84	8.75	3.63	11.3	0.75	7	0.38	14.66	13.16	10.45	2.5	0.2
		3	6.85	15.52	11.98	4.5	3.75	8.69	7.91	13.29	8.75	3.63	11.3	0.75	7	0.38	14.66	13.16	10.45	2.5	0.2
		5	6.85	15.52	11.98	4.5	3.75	8.69	7.91	13.29	8.75	3.63	11.3	0.75	7	0.38	14.66	13.16	10.45	2.5	0.2
		5	6.10	17.3	14.03	4.5	3.75	8.69	7.91	13.29	-	-	-	-	-	-	14.66	13.16	10.45	3.5	0.2
030-130	4	7.5	8.27	17.3	18.08	5.25	4.25	10.25	9.33	15.58	-	-	-	-	-	-	16.66	15.16	11.45	2.8	0.2
		10	8.86	17.3	18.08	5.25	4.25	10.25	9.33	15.58	-	-	-	-	-	-	16.66	15.16	11.45	2.8	0.2
		15	8.86	17.3	18.15	6.25	5	12.88	11.93	19.24	-	-	-	-	-	-	20	18.5	12.95	1.8	0.2
		20	8.86	17.3	18.15	6.25	5	12.88	11.93	19.24	-	-	-	-	-	-	20	18.5	12.95	1.8	0.2

Dimensions for pumps with TEFC motor and support rails [inch]																					
Pump size	Pole	P2 [hp]	Actual impeller size [inch]	MLE motor							Support rail under pump						Support rail under motor				
				LP	Q	D	E	T	AB	AG	L7	L8	B7	H5	H7	HG3	L4	L6	B4	H6	HG1
030-110	4	10	9.61	17.56	18.34	5.25	4.25	10.25	9.33	15.58	-	-	-	-	-	-	16.66	15.16	11.45	2.8	0.2
		15	10.79	17.56	18.41	6.25	5	12.88	11.93	19.24	-	-	-	-	-	-	20	18.5	12.95	1.8	0.2
		20	10.79	17.56	18.41	6.25	5	12.88	11.93	19.24	-	-	-	-	-	-	20	18.5	12.95	1.8	0.2
030-130	4	15	9.92	17.56	18.41	6.25	5	12.88	11.93	19.24	-	-	-	-	-	-	21	19.5	12.95	3.8	0.2
		20	11.26	17.56	18.41	6.25	5	12.88	11.93	19.24	-	-	-	-	-	-	21	19.5	12.95	3.8	0.2
		25	11.77	18.94	20.67	7	5.5	14.63	11.93	21.96	-	-	-	-	-	-	22.25	20.75	15.17	3	0.31
		30	12.91	18.94	20.67	7	5.5	14.63	11.93	21.96	-	-	-	-	-	-	22.25	20.75	15.17	3	0.31
040-070	2	15	5.43-4.80	18.13	18.21	6.25	5	12.88	9.33	15.58	8.75	3.63	13.98	1	8	0.5	20	18.5	12.95	1.8	0.2
		20	5.51	18.13	17.71	6.25	5	12.88	11.93	19.24	8.75	3.63	13.98	1	8	0.5	20	18.5	12.95	1.8	0.2
		25	5.51	16.44	16.27	7	5.5	14.63	11.93	20.23	8.75	3.63	13.98	1	8	0.5	22.25	20.75	13.95	1	0.5
		30	5.75	16.44	16.27	7	5.5	14.63	11.93	20.23	8.75	3.63	13.98	1	8	0.5	22.25	20.75	13.95	1	0.5
		1.5	4.72	16.52	13.74	4.5	3.75	8.69	6.22	10.84	-	-	-	-	-	-	14.66	13.16	10.45	2.5	0.2
040-070	4	2	5.12-4.80	16.52	13.74	4.5	3.75	8.69	6.22	10.84	-	-	-	-	-	-	14.66	13.16	10.45	2.5	0.2
		3	5.43	16.52	13.74	4.5	3.75	8.69	7.91	13.29	-	-	-	-	-	-	14.66	13.16	10.45	2.5	0.2
		5	6.30	16.52	13.74	4.5	3.75	8.69	7.91	13.29	-	-	-	-	-	-	14.66	13.16	10.45	2.5	0.2
		7.5	6.85	16.52	17.79	5.25	4.25	10.25	9.33	15.58	-	-	-	-	-	-	16.66	15.16	11.45	1.8	0.2
		10	6.85	16.52	17.79	5.25	4.25	10.25	9.33	15.58	-	-	-	-	-	-	16.66	15.16	11.45	1.8	0.2
040-095	4	7.5	7.13	17.8	18.08	5.25	4.25	10.25	9.33	15.58	-	-	-	-	-	-	16.66	15.16	11.45	3.8	0.2
		10	8.35	17.8	18.08	5.25	4.25	10.25	9.33	15.58	-	-	-	-	-	-	16.66	15.16	11.45	3.8	0.2
		15	8.35	17.8	18.15	6.25	5	12.88	11.93	19.24	-	-	-	-	-	-	20.5	19	12.95	2.8	0.2
		20	9.37	17.8	18.15	6.25	5	12.88	11.93	19.24	-	-	-	-	-	-	20.5	19	12.95	2.8	0.2
040-110	4	15	8.74	18.06	18.41	6.25	5	12.88	11.93	19.24	-	-	-	-	-	-	20.5	19	12.95	2.8	0.2
		20	10.08	18.06	18.41	6.25	5	12.88	11.93	19.24	-	-	-	-	-	-	20.5	19	12.95	2.8	0.2
		25	10.08	19.44	20.67	7	5.5	14.63	11.93	21.96	-	-	-	-	-	-	21.75	20.25	15.17	2	0.31
		30	10.08	19.44	20.67	7	5.5	14.63	11.93	21.96	-	-	-	-	-	-	21.75	20.25	15.17	2	0.31
040-130	4	15	9.29	18.06	18.48	6.25	5	12.88	11.93	19.24	-	-	-	-	-	-	21	19.5	12.95	3.8	0.2
		20	10.24	18.06	18.48	6.25	5	12.88	11.93	19.24	-	-	-	-	-	-	21	19.5	12.95	3.8	0.2
		25	10.98	19.44	20.74	7	5.5	14.63	11.93	21.96	-	-	-	-	-	-	22.25	20.75	15.17	3	0.31
		30	11.42	19.44	20.74	7	5.5	14.63	11.93	21.96	-	-	-	-	-	-	22.25	20.75	15.17	3	0.31
050-070	2	15	5.04	18.13	19.48	6.25	5	12.88	9.33	15.58	-	-	-	-	-	-	20	18.5	12.95	1.8	0.2
		20	5.04	18.13	18.98	6.25	5	12.88	11.93	19.24	-	-	-	-	-	-	20	18.5	12.95	1.8	0.2
		25	5.04	16.44	17.54	7	5.5	14.63	11.93	20.23	-	-	-	-	-	-	22.25	20.75	13.95	1	0.5
	4	30	5.43	16.44	17.54	7	5.5	14.63	11.93	20.23	-	-	-	-	-	-	22.25	20.75	13.95	1	0.5
		3	5.43	16.52	13.25	4.5	3.75	8.69	7.91	13.29	-	-	-	-	-	-	14.66	13.16	10.45	3.5	0.2
		5	6.85	16.52	13.25	4.5	3.75	8.69	7.91	13.29	-	-	-	-	-	-	14.66	13.16	10.45	3.5	0.2
050-095	4	7.5	6.93	16.52	17.3	5.25	4.25	10.25	9.33	15.58	-	-	-	-	-	-	16.66	15.16	11.45	2.8	0.2
		10	6.93	16.52	17.3	5.25	4.25	10.25	9.33	15.58	-	-	-	-	-	-	16.66	15.16	11.45	2.8	0.2
		10	7.68	19.83	20.11	5.25	4.25	10.25	9.33	15.58	-	-	-	-	-	-	17.5	16	11.45	4.8	0.2
		15	8.19	19.83	20.18	6.25	5	12.88	11.93	19.24	-	-	-	-	-	-	21	19.5	12.95	3.8	0.2
		20	8.58	19.83	20.18	6.25	5	12.88	11.93	19.24	-	-	-	-	-	-	21	19.5	12.95	3.8	0.2
		25	9.13	20.34	21.57	7	5.5	14.63	11.93	21.96	-	-	-	-	-	-	22.25	20.75	15.17	3	0.31
050-110	4	30	9.13	20.34	21.57	7	5.5	14.63	11.93	21.96	-	-	-	-	-	-	22.25	20.75	15.17	3	0.31
		15	8.35	18.06	18.41	6.25	5	12.88	11.93	19.24	-	-	-	-	-	-	21	19.5	12.95	3.8	0.2
		20	9.13	18.06	18.41	6.25	5	12.88	11.93	19.24	-	-	-	-	-	-	21	19.5	12.95	3.8	0.2
		25	9.13	19.44	20.67	7	5.5	14.63	11.93	21.96	-	-	-	-	-	-	22.25	20.75	15.17	3	0.31
		30	9.61	19.44	20.67	7	5.5	14.63	11.93	21.96	-	-	-	-	-	-	22.25	20.75	15.17	3	0.31

Dimensions for pumps with TEFC motor and support rails [inch]																					
Pump size	Pole	P2 [hp]	Actual impeller size [inch]	MLE motor						Support rail under pump						Support rail under motor					
				LP	Q	D	E	T	AB	AG	L7	L8	B7	H5	H7	HG3	L4	L6	B4	H6	HG1
060-095	4	15	7.32	20.58	19.58	6.25	5	12.88	11.93	19.24	-	-	-	-	-	-	21.5	20	12.95	4.8	0.2
		20	7.95	20.58	19.58	6.25	5	12.88	11.93	19.24	-	-	-	-	-	-	21.5	20	12.95	4.8	0.2
		25	8.43	21.09	20.97	7	5.5	14.63	11.93	21.96	-	-	-	-	-	-	22.75	21.25	15.17	4	0.31
		30	8.90	21.09	20.97	7	5.5	14.63	11.93	21.96	-	-	-	-	-	-	22.75	21.25	15.17	4	0.31
060-110	4	25	8.78	21.6	21.48	7	5.5	14.63	11.93	21.96	-	-	-	-	-	-	22.75	21.25	15.17	4	0.31
		30	8.78	21.6	21.48	7	5.5	14.63	11.93	21.96	-	-	-	-	-	-	22.75	21.25	15.17	4	0.31

## Dimensions in mm.

Dimensions for pumps with TEFC motor and support rails [mm]																					
Pump size	Pole	P2 [hp]	Actual impeller size [mm]	MLE motor						Support rail under pump						Support rail under motor					
				LP	Q	D	E	T	AB	AG	L7	L8	B7	H5	H7	HG3	L4	L6	B4	H6	HG1
012-070	2	3	119	372	317	114	95	221	158	275	197	80	290	44	178	5	349	311	265	64	5
		5	127	372	317	114	95	221	201	338	197	80	290	44	178	5	349	311	265	64	5
		7.5	139	372	420	133	108	260	201	372	197	80	290	44	178	5	423	385	291	46	5
		7.5	155	372	420	133	108	260	201	372	197	80	290	44	178	5	423	385	291	46	5
		10	177	372	420	133	108	260	237	396	197	80	290	44	178	5	423	385	291	46	5
		15	169	372	415	159	127	327	237	396	197	80	290	44	178	5	514	476	304	20	10
	4	15	177	372	415	159	127	327	237	396	197	80	290	44	178	5	514	476	304	20	10
		1.5	177	372	317	114	95	221	158	275	197	80	290	44	178	5	349	311	265	64	5
		2	177	372	317	114	95	221	158	275	197	80	290	44	178	5	349	311	265	64	5
		5	114	372	317	114	95	221	201	338	197	80	290	44	178	5	349	311	265	64	5
015-070	2	7.5	128	372	420	133	108	260	201	372	197	80	290	44	178	5	423	385	291	46	5
		10	171	372	420	133	108	260	237	396	197	80	290	44	178	5	423	385	291	46	5
		15	176	372	415	159	127	327	237	396	197	80	290	44	178	5	514	476	304	20	10
		1.5	166	372	317	114	95	221	158	275	197	80	290	44	178	5	349	311	265	64	5
		2	176	372	317	114	95	221	158	275	197	80	290	44	178	5	349	311	265	64	5
		3	176	372	317	114	95	221	201	338	197	80	290	44	178	5	349	311	265	64	5
	4	5	176	372	317	114	95	221	201	338	197	80	290	44	178	5	349	311	265	64	5
		15	198	435	463	159	127	327	237	396	222	92	325	25	203	13	508	470	329	46	5
		20	224	435	450	159	127	327	303	489	222	92	325	25	203	13	508	470	329	46	5
		25	224	392	413	178	140	372	303	514	222	92	325	25	203	13	565	527	354	25	13
015-090	2	30	250	392	413	178	140	372	303	514	222	92	325	25	203	13	565	527	354	25	13
		1.5	184	394	349	114	95	221	158	275	-	-	-	-	-	-	372	334	265	64	5
		2	206	394	349	114	95	221	158	275	-	-	-	-	-	-	372	334	265	64	5
		3	250	394	349	114	95	221	201	338	-	-	-	-	-	-	372	334	265	64	5
	4	5	250	394	349	114	95	221	201	338	-	-	-	-	-	-	372	334	265	64	5
		7.5	250	394	452	133	108	260	237	396	-	-	-	-	-	-	423	385	291	46	5
		10	250	394	452	133	108	260	237	396	-	-	-	-	-	-	423	385	291	46	5
		10	250	394	452	133	108	260	237	396	-	-	-	-	-	-	423	385	291	46	5



Dimensions for pumps with TEFC motor and support rails [mm]

Pump size	Pole	Actual impeller size [mm]	Dimensions for pumps with TEFC motor and support rails [mm]																		
			MLE motor							Support rail under pump						Support rail under motor					
			LP	Q	D	E	T	AB	AG	L7	L8	B7	H5	H7	HG3	L4	L6	B4	H6	HG1	
015-095	2	15	178	435	463	159	127	327	237	396	222	92	325	25	203	13	508	470	329	46	5
		20	200	435	450	159	127	327	303	489	222	92	325	25	203	13	508	470	329	46	5
		25	200	392	413	178	140	372	303	514	222	92	325	25	203	13	565	527	354	25	13
		30	224	392	413	178	140	372	303	514	222	92	325	25	203	13	565	527	354	25	13
	4	2	186	394	349	114	95	221	158	275	-	-	-	-	-	-	372	334	265	64	5
		3	212	394	349	114	95	221	201	338	-	-	-	-	-	-	372	334	265	64	5
		5	224	394	349	114	95	221	201	338	-	-	-	-	-	-	372	334	265	64	5
		7.5	250	394	452	133	108	260	237	396	-	-	-	-	-	-	423	385	291	46	5
		10	250	394	452	133	108	260	237	396	-	-	-	-	-	-	423	385	291	46	5
		15	250	394	452	133	108	260	237	396	-	-	-	-	-	-	423	385	291	46	5
020-095	2	15	159	446	473	159	127	327	237	396	222	92	325	25	203	13	508	470	329	46	5
		20	182	446	460	159	127	327	303	489	222	92	325	25	203	13	508	470	329	46	5
		25	193	403	424	178	140	372	303	514	222	92	325	25	203	13	565	527	354	25	13
		30	204	403	424	178	140	372	303	514	222	92	325	25	203	13	565	527	354	25	13
	4	2	148	394	349	114	95	221	158	275	-	-	-	-	-	-	372	334	265	64	5
		3	184	394	349	114	95	221	201	338	-	-	-	-	-	-	372	334	265	64	5
		5	240	394	349	114	95	221	201	338	-	-	-	-	-	-	372	334	265	64	5
		7.5	240	394	452	133	108	260	237	396	-	-	-	-	-	-	423	385	291	46	5
		10	240	394	452	133	108	260	237	396	-	-	-	-	-	-	423	385	291	46	5
		15	240	394	452	133	108	260	237	396	-	-	-	-	-	-	423	385	291	46	5
020-110	4	5	228	394	349	114	95	221	201	338	-	-	-	-	-	372	334	265	64	5	
		7.5	252	394	452	133	108	260	237	396	-	-	-	-	-	423	385	291	46	5	
	2	10	252	394	452	133	108	260	237	396	-	-	-	-	-	423	385	291	46	5	
		15	262	394	435	159	127	327	303	489	-	-	-	-	-	514	476	304	20	10	
		20	252	394	435	159	127	327	303	489	-	-	-	-	-	514	476	304	20	10	
020-130	4	7.5	258	446	478	133	108	260	237	396	-	-	-	-	-	423	385	291	97	5	
		10	290	446	478	133	108	260	237	396	-	-	-	-	-	423	385	291	97	5	
		15	318	446	480	159	127	327	303	489	-	-	-	-	-	521	483	329	71	5	
	2	20	338	446	480	159	127	327	303	489	-	-	-	-	-	521	483	329	71	5	
		25	338	481	537	178	140	372	303	558	-	-	-	-	-	552	514	385	51	8	
		30	338	481	537	178	140	372	303	558	-	-	-	-	-	552	514	385	51	8	
		5	116	394	304	114	95	221	201	338	222	92	287	19	178	10	372	334	265	64	5
025-070	2	7.5	116	394	407	133	108	260	201	372	222	92	287	19	178	10	423	385	291	46	5
		10	126	394	407	133	108	260	237	396	222	92	287	19	178	10	423	385	291	46	5
		15	169	394	403	159	127	327	237	396	222	92	287	19	178	10	514	476	304	20	10
		20	172	394	390	159	127	327	303	489	222	92	287	19	178	10	514	476	304	20	10
	4	25	172	392	410	178	140	372	303	514	229	95	312	44	203	5	565	527	354	25	13
		30	172	392	410	178	140	372	303	514	229	95	312	44	203	5	565	527	354	25	13
		1.5	134	394	304	114	95	221	158	275	222	92	287	19	178	10	372	334	265	64	5
		2	166	394	304	114	95	221	158	275	222	92	287	19	178	10	372	334	265	64	5
		3	168	394	304	114	95	221	201	338	222	92	287	19	178	10	372	334	265	64	5
		5	172	394	304	114	95	221	201	338	222	92	287	19	178	10	372	334	265	64	5
025-095	2	25	167	403	458	178	140	372	303	514	-	-	-	-	-	565	527	354	25	13	
		30	182	403	458	178	140	372	303	514	-	-	-	-	-	565	527	354	25	13	
	4	3	152	394	339	114	95	221	201	338	-	-	-	-	-	372	334	265	89	5	
		5	232	394	339	114	95	221	201	338	-	-	-	-	-	372	334	265	89	5	
		7.5	242	394	441	133	108	260	237	396	-	-	-	-	-	423	385	291	71	5	
		10	242	394	441	133	108	260	237	396	-	-	-	-	-	423	385	291	71	5	

Dimensional drawings and technical data

Dimensions for pumps with TEFC motor and support rails [mm]																					
Pump size	Pole	P2 [hp]	Actual impeller size [mm]	MLE motor						Support rail under pump						Support rail under motor					
				LP	Q	D	E	T	AB	AG	L7	L8	B7	H5	H7	HG3	L4	L6	B4	H6	HG1
025-110	4	7.5	240	446	466	133	108	260	237	396	-	-	-	-	-	-	423	385	291	71	5
		10	270	446	466	133	108	260	237	396	-	-	-	-	-	-	423	385	291	71	5
		15	280	446	468	159	127	327	303	489	-	-	-	-	-	-	508	470	329	46	5
		20	280	446	468	159	127	327	303	489	-	-	-	-	-	-	508	470	329	46	5
030-070	2	7.5	128	394	407	133	108	260	201	372	222	92	287	19	178	10	423	385	291	46	5
		10	137	394	407	133	108	260	237	396	222	92	287	19	178	10	423	385	291	46	5
		15	149	394	403	159	127	327	237	396	222	92	287	19	178	10	514	476	304	20	10
		20	153	394	390	159	127	327	303	489	222	92	287	19	178	10	514	476	304	20	10
	4	25	174	392	410	178	140	372	303	514	229	95	312	44	203	5	565	527	354	25	13
		30	174	392	410	178	140	372	303	514	229	95	312	44	203	5	565	527	354	25	13
		1.5	132	394	304	114	95	221	158	275	222	92	287	19	178	10	372	334	265	64	5
		2	145	394	304	114	95	221	158	275	222	92	287	19	178	10	372	334	265	64	5
4	3	174	394	304	114	95	221	201	338	222	92	287	19	178	10	372	334	265	64	5	
	5	174	394	304	114	95	221	201	338	222	92	287	19	178	10	372	334	265	64	5	
	5	155	439	356	114	95	221	201	338	-	-	-	-	-	-	372	334	265	89	5	
030-095	4	7.5	210	439	459	133	108	260	237	396	-	-	-	-	-	-	423	385	291	71	5
		10	225	439	459	133	108	260	237	396	-	-	-	-	-	-	423	385	291	71	5
		15	225	439	461	159	127	327	303	489	-	-	-	-	-	-	508	470	329	46	5
		20	225	439	461	159	127	327	303	489	-	-	-	-	-	-	508	470	329	46	5
030-110	4	10	244	446	466	133	108	260	237	396	-	-	-	-	-	-	423	385	291	71	5
		15	274	446	468	159	127	327	303	489	-	-	-	-	-	-	508	470	329	46	5
		20	274	446	468	159	127	327	303	489	-	-	-	-	-	-	508	470	329	46	5
030-130	4	15	252	446	468	159	127	327	303	489	-	-	-	-	-	-	533	495	329	97	5
		20	286	446	468	159	127	327	303	489	-	-	-	-	-	-	533	495	329	97	5
		25	299	481	525	178	140	372	303	558	-	-	-	-	-	-	565	527	385	76	8
		30	328	481	525	178	140	372	303	558	-	-	-	-	-	-	565	527	385	76	8
040-070	2	15	130	461	463	159	127	327	237	396	222	92	355	25	203	13	508	470	329	46	5
		20	140	461	450	159	127	327	303	489	222	92	355	25	203	13	508	470	329	46	5
		25	140	418	413	178	140	372	303	514	222	92	355	25	203	13	565	527	354	25	13
	4	30	146	418	413	178	140	372	303	514	222	92	355	25	203	13	565	527	354	25	13
		1.5	120	420	349	114	95	221	158	275	-	-	-	-	-	-	372	334	265	64	5
040-095	4	2	126	420	349	114	95	221	158	275	-	-	-	-	-	-	372	334	265	64	5
		3	138	420	349	114	95	221	201	338	-	-	-	-	-	-	372	334	265	64	5
		5	160	420	349	114	95	221	201	338	-	-	-	-	-	-	372	334	265	64	5
		7.5	174	420	452	133	108	260	237	396	-	-	-	-	-	-	423	385	291	46	5
040-110	4	10	174	420	452	133	108	260	237	396	-	-	-	-	-	-	423	385	291	46	5
		7.5	181	452	459	133	108	260	237	396	-	-	-	-	-	-	423	385	291	97	5
		10	212	452	459	133	108	260	237	396	-	-	-	-	-	-	423	385	291	97	5
		15	212	452	461	159	127	327	303	489	-	-	-	-	-	-	521	483	329	71	5
		20	238	452	461	159	127	327	303	489	-	-	-	-	-	-	521	483	329	71	5
040-130	4	15	222	459	468	159	127	327	303	489	-	-	-	-	-	-	521	483	329	71	5
		20	256	459	468	159	127	327	303	489	-	-	-	-	-	-	521	483	329	71	5
		25	256	494	525	178	140	372	303	558	-	-	-	-	-	-	552	514	385	51	8
		30	256	494	525	178	140	372	303	558	-	-	-	-	-	-	552	514	385	51	8
040-130	4	15	236	459	469	159	127	327	303	489	-	-	-	-	-	-	533	495	329	97	5
		20	260	459	469	159	127	327	303	489	-	-	-	-	-	-	533	495	329	97	5
		25	279	494	527	178	140	372	303	558	-	-	-	-	-	-	565	527	385	76	8
		30	290	494	527	178	140	372	303	558	-	-	-	-	-	-	565	527	385	76	8

Dimensions for pumps with TEFC motor and support rails [mm]																					
Pump size	Pole	P2 [hp]	Actual impeller size [mm]	MLE motor						Support rail under pump						Support rail under motor					
				LP	Q	D	E	T	AB	AG	L7	L8	B7	H5	H7	HG3	L4	L6	B4	H6	HG1
050-070	2	15	128	461	495	159	127	327	237	396	-	-	-	-	-	-	508	470	329	46	5
		20	128	461	482	159	127	327	303	489	-	-	-	-	-	-	508	470	329	46	5
		25	128	418	446	178	140	372	303	514	-	-	-	-	-	-	565	527	354	25	13
	4	30	138	418	446	178	140	372	303	514	-	-	-	-	-	-	565	527	354	25	13
		3	138	420	337	114	95	221	201	338	-	-	-	-	-	-	372	334	265	89	5
		5	174	420	337	114	95	221	201	338	-	-	-	-	-	-	372	334	265	89	5
		7.5	176	420	439	133	108	260	237	396	-	-	-	-	-	-	423	385	291	71	5
10	176	420	439	133	108	260	237	396	-	-	-	-	-	-	423	385	291	71	5		
050-095	4	10	195	504	511	133	108	260	237	396	-	-	-	-	-	-	445	406	291	122	5
		15	208	504	513	159	127	327	303	489	-	-	-	-	-	-	533	495	329	97	5
		20	218	504	513	159	127	327	303	489	-	-	-	-	-	-	533	495	329	97	5
		25	232	517	548	178	140	372	303	558	-	-	-	-	-	-	565	527	385	76	8
050-110	4	30	232	517	548	178	140	372	303	558	-	-	-	-	-	-	565	527	385	76	8
		15	212	459	468	159	127	327	303	489	-	-	-	-	-	-	533	495	329	97	5
		20	232	459	468	159	127	327	303	489	-	-	-	-	-	-	533	495	329	97	5
		25	232	494	525	178	140	372	303	558	-	-	-	-	-	-	565	527	385	76	8
060-095	4	30	244	494	525	178	140	372	303	558	-	-	-	-	-	-	565	527	385	76	8
		15	186	523	497	159	127	327	303	489	-	-	-	-	-	-	546	508	329	122	5
		20	202	523	497	159	127	327	303	489	-	-	-	-	-	-	546	508	329	122	5
		25	214	536	533	178	140	372	303	558	-	-	-	-	-	-	578	540	385	102	8
060-110	4	30	226	536	533	178	140	372	303	558	-	-	-	-	-	-	578	540	385	102	8
		25	223	549	546	178	140	372	303	558	-	-	-	-	-	-	578	540	385	102	8
		30	223	549	546	178	140	372	303	558	-	-	-	-	-	-	578	540	385	102	8

### Dimensions for NBSE pumps (230 V)

Dimensions in inch.

Dimensions for pumps with TEFC motor and support rails [inch]																					
Pump size	Pole	P2 [hp]	Actual impeller size [inch]	MLE motor						Support rail under pump						Support rail under motor					
				LP	Q	D	E	T	AB	AG	L7	L8	B7	H5	H7	HG3	L4	L6	B4	H6	HG1
012-070	2	3	4.69	14.64	12.47	4.5	3.75	8.69	7.91	13.29	7.75	3.13	11.42	1.75	7	0.2	13.75	12.25	10.45	2.5	0.2
		5	5.00	14.64	12.47	4.5	3.75	8.69	7.91	13.29	7.75	3.13	11.42	1.75	7	0.2	13.75	12.25	10.45	2.5	0.2
		7.5	6.10	14.64	16.52	5.25	4.25	10.25	9.33	15.58	7.75	3.13	11.42	1.75	7	0.2	16.66	15.16	11.45	1.75	0.2
		10	6.97	14.64	15.84	5.25	5	10.25	11.93	19.24	7.75	3.13	11.42	1.75	7	0.2	20.25	18.75	11.97	0.75	0.38
		15	6.97	14.64	15.84	6.25	5	12.88	11.93	19.24	7.75	3.13	11.42	1.75	7	0.2	20.25	18.75	11.97	0.75	0.38
015-070	2	5	4.49	14.64	12.47	4.5	3.75	8.69	7.91	13.29	7.75	3.13	11.42	1.75	7	0.2	13.75	12.25	10.45	2.5	0.2
		7.5	5.04	14.64	16.52	5.25	4.25	10.25	9.33	15.58	7.75	3.13	11.42	1.75	7	0.2	16.66	15.16	11.45	1.75	0.2
		10	6.73	14.64	15.84	5.25	5	10.25	11.93	19.24	7.75	3.13	11.42	1.75	7	0.2	20.25	18.75	11.97	0.75	0.38
		15	6.93	14.64	15.84	6.25	5	12.88	11.93	19.24	7.75	3.13	11.42	1.75	7	0.2	20.25	18.75	11.97	0.75	0.38
025-070	2	5	4.57	15.52	11.98	4.5	3.75	8.69	7.91	13.29	8.75	3.63	11.3	0.75	7	0.38	14.66	13.16	10.45	2.5	0.2
		7.5	4.57	15.52	16.03	5.25	4.25	10.25	9.33	15.58	8.75	3.63	11.3	0.75	7	0.38	16.66	15.16	11.45	1.75	0.2
		10	4.96	15.52	15.35	5.25	5	10.25	11.93	19.24	8.75	3.63	11.3	0.75	7	0.38	20.25	18.75	11.97	0.75	0.38
		15	6.65	15.52	15.35	6.25	5	12.88	11.93	19.24	8.75	3.63	11.3	0.75	7	0.38	20.25	18.75	11.97	0.75	0.38

Dimensions for pumps with TEFC motor and support rails [inch]																					
Pump size	Pole	P2 [hp]	Actual impeller size [inch]	MLE motor						Support rail under pump						Support rail under motor					
				LP	Q	D	E	T	AB	AG	L7	L8	B7	H5	H7	HG3	L4	L6	B4	H6	HG1
030-070	2	7.5	5.04	15.52	16.03	5.25	4.25	10.25	9.33	15.58	8.75	3.63	11.3	0.75	7	0.38	16.66	15.16	11.45	1.75	0.2
		10	5.39	15.52	15.35	5.25	5	10.25	11.93	19.24	8.75	3.63	11.3	0.75	7	0.38	20.25	18.75	11.97	0.75	0.38
		15	5.87	15.52	15.35	6.25	5	12.88	11.93	19.24	8.75	3.63	11.3	0.75	7	0.38	20.25	18.75	11.97	0.75	0.38

## Dimensions in mm.

Dimensions for pumps with TEFC motor and support rails [mm]																					
Pump size	Pole	P2 [hp]	Actual impeller size [mm]	MLE motor						Support rail under pump						Support rail under motor					
				LP	Q	D	E	T	AB	AG	L7	L8	B7	H5	H7	HG3	L4	L6	B4	H6	HG1
012-070	3	119	372	317	114	95	221	201	338	197	80	290	44	178	5	349	311	265	64	5	
		5	127	372	317	114	95	221	201	338	197	80	290	44	178	5	349	311	265	64	5
	2	7.5	155	372	420	133	108	260	237	396	197	80	290	44	178	5	423	385	291	44	5
		10	177	372	402	133	127	260	303	489	197	80	290	44	178	5	514	476	304	19	10
		15	177	372	402	159	127	327	303	489	197	80	290	44	178	5	514	476	304	19	10
015-070	5	114	372	317	114	95	221	201	338	197	80	290	44	178	5	349	311	265	64	5	
		7.5	128	372	420	133	108	260	237	396	197	80	290	44	178	5	423	385	291	44	5
	2	10	171	372	402	133	127	260	303	489	197	80	290	44	178	5	514	476	304	19	10
		15	176	372	402	159	127	327	303	489	197	80	290	44	178	5	514	476	304	19	10
025-070	5	116	394	304	114	95	221	201	338	222	92	287	19	178	10	372	334	265	64	5	
		7.5	116	394	407	133	108	260	237	396	222	92	287	19	178	10	423	385	291	44	5
	2	10	126	394	390	133	127	260	303	489	222	92	287	19	178	10	514	476	304	19	10
		15	169	394	390	159	127	327	303	489	222	92	287	19	178	10	514	476	304	19	10
030-070	2	7.5	128	394	407	133	108	260	237	396	222	92	287	19	178	10	423	385	291	44	5
		10	137	394	390	133	127	260	303	489	222	92	287	19	178	10	514	476	304	19	10
		15	149	394	390	159	127	327	303	489	222	92	287	19	178	10	514	476	304	19	10

Dimensional drawings, NBS

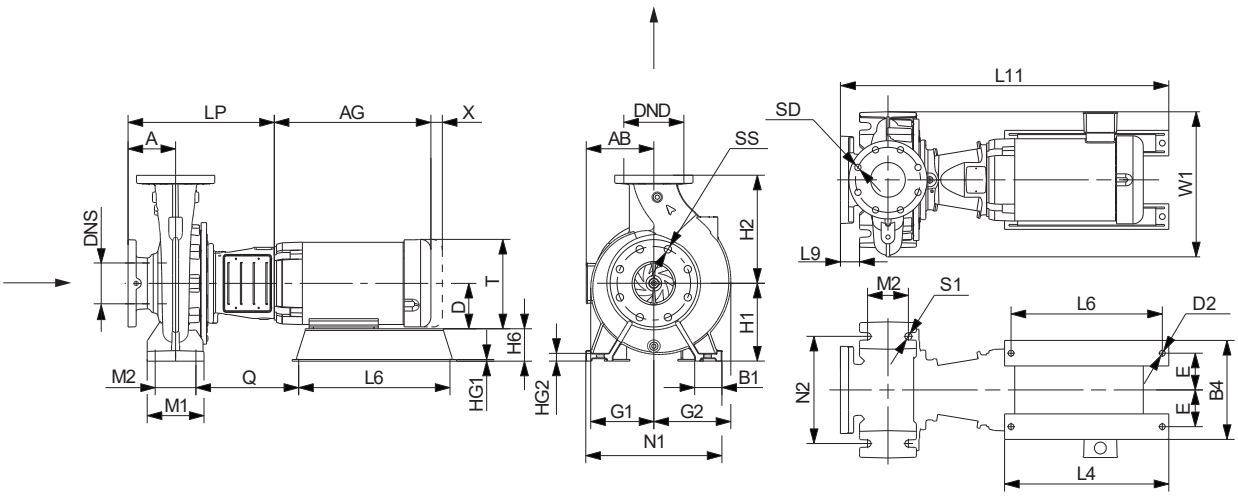

TM077961

Dimensional drawing, mounting design B, center outlet

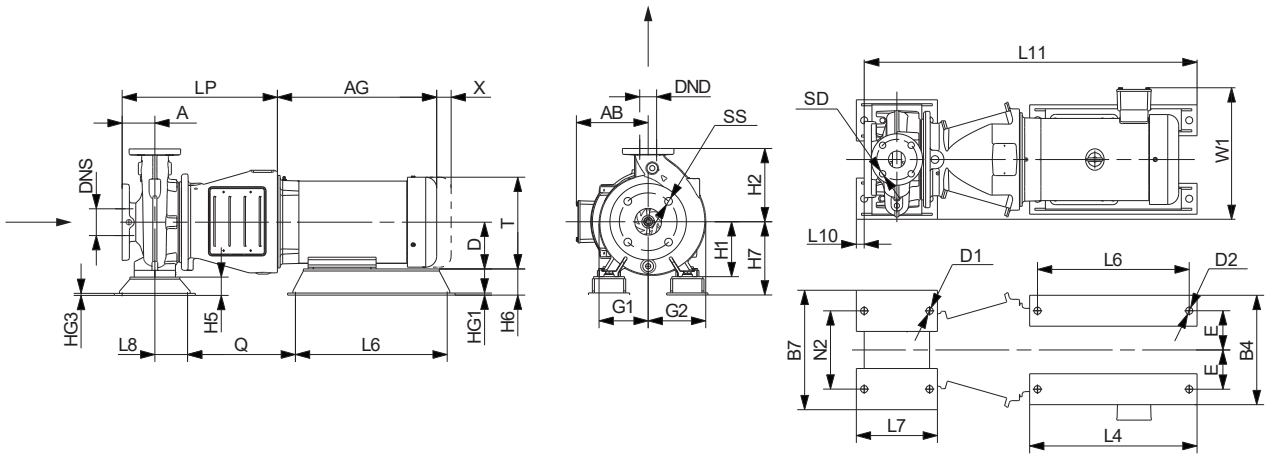

TM077962

Dimensional drawing, mounting design C, center outlet

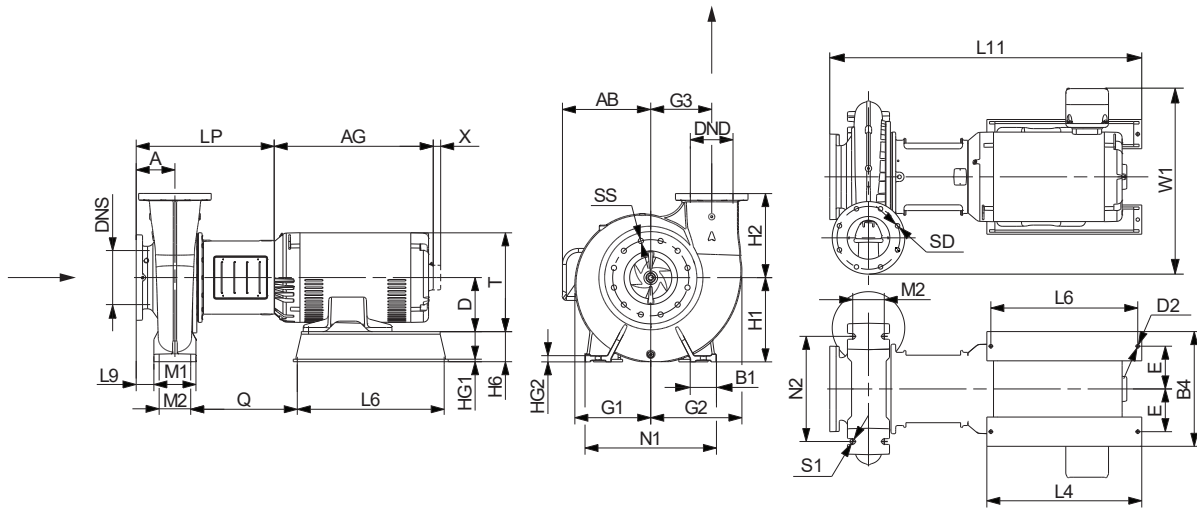

TM077963

Dimensional drawing, mounting design B, tangential outlet

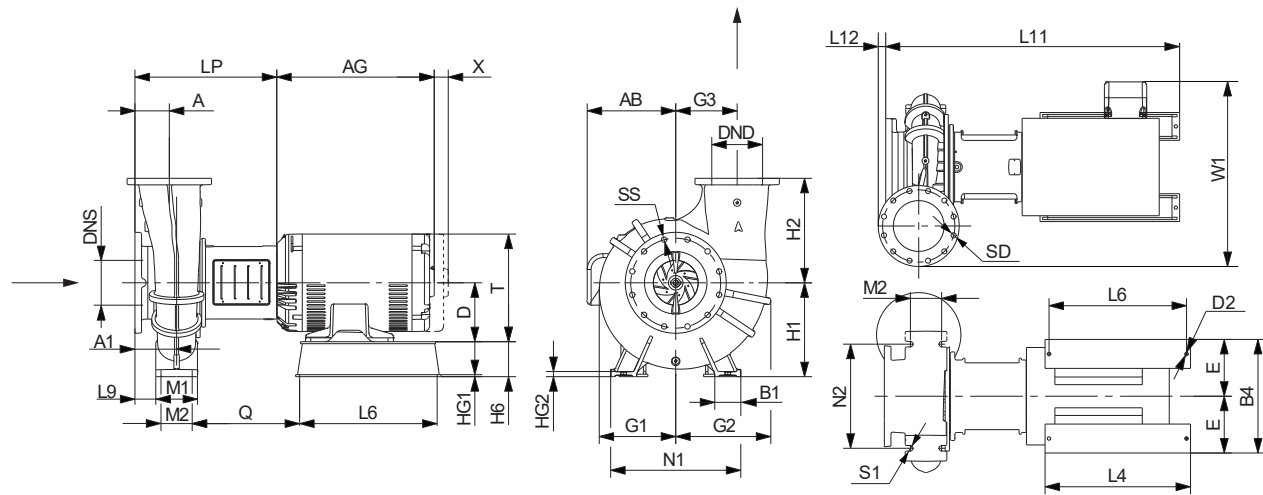

TM079187

Dimensional drawing, mounting design B, tangential outlet

## Flange and bare pump dimensions

### Dimensions in inch.

Pump size	Flanges 175 PSI Class 125 [inch]				Flanges 363 PSI Class 300 [inch]				Bare pump dimensions [inch]													
	DNS	DND	SS	SD	DNS	DND	SS	SD	H1	H2	A	A5	B1	N1	N2	M1	M2	S1	G1	G2	G3	HG2
012-070	1.97	1.26	4x3/4	4x5/8	1.97	1.26	8x3/4	4x3/4	5.25	7	3.13	-	1.97	9.45	7.48	3.94	2.76	M12	4.53	5.08	-	0.6
015-070	2.5	1.5	4x3/4	4x5/8	2.5	1.5	8x7/8	4x7/8	5.25	7	3.13	-	1.97	9.45	7.48	3.94	2.76	M12	4.69	5.51	-	0.5
015-090	2.5	1.5	4x3/4	4x5/8	2.5	1.5	8x7/8	4x7/8	7	9	4	-	2.56	12.6	9.84	4.92	3.74	M12	5.71	6.22	-	0.7
015-095	2.5	1.5	4x3/4	4x5/8	2.5	1.5	8x7/8	4x7/8	7	9	4	-	2.56	12.6	9.84	4.92	3.74	M12	5.94	6.69	-	0.7
020-095	2.5	2	4x3/4	4x3/4	2.5	2	8x7/8	8x3/4	7	9	4	-	2.56	12.6	9.84	4.92	3.74	M12	5.91	6.48	-	0.8
020-110	2.5	2	4x3/4	4x3/4	2.5	2	8x7/8	8x3/4	7	9	4	-	2.56	12.6	9.84	4.92	3.74	M12	6.42	6.96	-	0.7
020-135	3	2	4x3/4	4x3/4	3	2	8x7/8	8x3/4	9	11	5	-	2.56	13.58	11.02	4.92	3.74	M12	8.03	8.58	-	0.7
025-070	3	2.5	4x3/4	4x3/4	3	2.5	8x7/8	8x7/8	6.25	8	4	-	2.56	11.02	8.35	4.92	3.74	M12	4.72	5.57	-	0.6
025-095	3	2.5	4x3/4	4x3/4	3	2.5	8x7/8	8x7/8	8	10	4	-	3.15	14.17	11.02	6.3	4.72	M16	6.47	7.34	-	0.9
025-110	3	2.5	4x3/4	4x3/4	3	2.5	8x7/8	8x7/8	8	11	5	-	3.15	14.17	11.02	6.3	4.72	M16	6.93	7.7	-	0.7
030-070	4	3	8x3/4	4x3/4	4	3	8x7/8	8x7/8	6.25	9	4	-	2.56	11.02	8.35	4.92	3.74	M12	5.3	6.5	-	0.7
030-095	4	3	8x3/4	4x3/4	4	3	8x7/8	8x7/8	8	11	5	-	3.15	15.75	12.4	6.3	4.72	M16	6.09	8.22	-	0.8
030-110	4	3	8x3/4	4x3/4	4	3	8x7/8	8x7/8	8	12.5	5	-	3.15	15.75	12.4	6.3	4.72	M16	7.09	8.02	-	0.8
030-135	4	3	8x3/4	4x3/4	4	3	8x7/8	8x7/8	10	12.5	5	-	2.99	15.75	12.4	6.3	4.72	M16	8.19	9.39	-	0.6
040-070	5	4	8x7/8	8x3/4	5	4	8x7/8	8x7/8	7	10	5	-	2.56	13.58	11.02	4.92	3.74	M12	5.52	7.11	-	0.7
040-095	5	4	8x7/8	8x3/4	5	4	8x7/8	8x7/8	9	11	5.5	-	3.15	15.75	12.4	6.3	4.72	M16	7.11	8.91	-	1
040-110	5	4	8x7/8	8x3/4	5	4	8x7/8	8x7/8	9	12.5	5.5	-	3.15	15.75	12.4	6.3	4.72	M16	6.03	8.91	-	0.8
040-135	5	4	8x7/8	8x3/4	5	4	8x7/8	8x7/8	10	12.5	5.5	-	3.15	15.75	12.4	6.3	4.72	M16	8.11	9.6	-	0.9
040-150	5	4	8x7/8	8x3/4	5	4	8x7/8	8x7/8	11	14	5.5	-	3.94	19.69	15.75	7.87	5.91	M20	10.43	11.73	-	0.7
050-070	6	5	8x7/8	8x7/8	6	5	12x7/8	8x7/8	8	11	5	-	3.15	14.17	11.02	6.3	4.72	M16	6.37	8.47	-	0.7
050-095	6	5	8x7/8	8x7/8	6	5	12x7/8	8x7/8	10	14	5.5	-	3.15	15.75	12.4	6.3	4.72	M16	7.2	9.29	-	1.1
050-110	6	5	8x7/8	8x7/8	6	5	12x7/8	8x7/8	10	14	5.5	-	3.39	15.98	12.4	6.3	4.72	M16	8.14	10	-	0.9
050-135	6	5	8x7/8	8x7/8	6	5	12x7/8	8x7/8	11	14	5.5	-	3.94	19.69	15.75	7.87	5.91	M20	8.78	10.63	-	0.9
050-150	6	5	8x7/8	8x7/8	6	5	12x7/8	8x7/8	12.5	15.75	5.5	-	3.94	19.69	15.75	7.87	5.91	M20	10.89	12.85	-	1
060-095	8	6	8x7/8	8x7/8	8	6	12x1	12x7/8	11	14.75	6.25	-	3.94	19.69	15.75	7.87	5.91	M20	9.06	11.81	-	0.7
060-110	8	6	8x7/8	8x7/8	8	6	12x1	12x7/8	11	14.75	6.25	-	3.94	19.69	15.75	7.87	5.91	M20	8.78	11.3	-	0.9
060-135	8	6	8x7/8	8x7/8	8	6	12x1	12x7/8	11	15.75	6.25	-	3.94	21.65	17.72	7.87	5.91	M20	10.04	12.36	-	0.9
060-150	8	6	8x7/8	8x7/8	8	6	12x1	12x7/8	12.5	17.75	6.25	-	3.94	21.65	17.72	7.87	5.91	M20	11.34	14	-	0.9
080-135	10	8	12x1	8x7/8	10	8	16x1 1/8	12x1	13.75	14	6.25	-	4.92	24.61	19.69	7.87	5.91	M20	12.37	17.22	10.43	1.1
080-150	10	8	12x1	8x7/8	10	8	16x1 1/8	12x1	15.75	15.75	7.25	-	4.92	24.61	19.69	7.87	5.91	M20	14.21	18.21	11.42	1.1
100-150	12	10	12x1	12x1	12	10	16x1 1/4	16x1 1/8	17.75	19.75	6.5	1.38	4.92	24.61	19.69	7.87	5.91	M20	14.45	19.59	11.61	0.9

## Dimensions in mm.

Pump size	Flanges 175 PSI Class 125 [mm]				Flanges 363 PSI Class 300 [mm]				Bare pump dimensions [mm]													
	DNS	DND	SS	SD	DNS	DND	SS	SD	H1	H2	A	A5	B1	N1	N2	M1	M2	S1	G1	G2	G3	HG2
012-070	50	32	4x19	4x16	50	32	8x19	4x19	133	178	79	-	50	240	190	100	70	M12	115	129	-	15
015-070	64	38	4x19	4x16	64	38	8x22.3	4x22.3	133	178	79	-	50	240	190	100	70	M12	119	140	-	13
015-090	64	38	4x19	4x16	64	38	8x22.3	4x22.3	178	229	102	-	65	320	250	125	95	M12	145	158	-	18
015-095	64	38	4x19	4x16	64	38	8x22.3	4x22.3	178	229	102	-	65	320	250	125	95	M12	151	170	-	18
020-095	64	51	4x19	4x19	64	51	8x22.3	8x19	178	229	102	-	65	320	250	125	95	M12	150	165	-	20
020-110	64	51	4x19	4x19	64	51	8x22.3	8x19	178	229	102	-	65	320	250	125	95	M12	163	177	-	18
020-135	76	51	4x19	4x19	76	51	8x22.3	8x19	229	279	127	-	65	345	280	125	95	M12	204	218	-	18
025-070	76	64	4x19	4x19	76	64	8x22.3	8x22.3	159	203	102	-	65	280	212	125	95	M12	120	142	-	15
025-095	76	64	4x19	4x19	76	64	8x22.3	8x22.3	203	254	102	-	80	360	280	160	120	M16	164	187	-	23
025-110	76	64	4x19	4x19	76	64	8x22.3	8x22.3	203	279	127	-	80	360	280	160	120	M16	176	196	-	18
030-070	102	76	8x19	4x19	102	76	8x22.3	8x22.3	159	229	102	-	65	280	212	125	95	M12	135	165	-	18
030-095	102	76	8x19	4x19	102	76	8x22.3	8x22.3	203	279	127	-	80	400	315	160	120	M16	155	209	-	20
030-110	102	76	8x19	4x19	102	76	8x22.3	8x22.3	203	318	127	-	80	400	315	160	120	M16	180	204	-	20
030-135	102	76	8x19	4x19	102	76	8x22.3	8x22.3	254	318	127	-	76	400	315	160	120	M16	208	239	-	15
040-070	127	102	8x22.3	8x19	127	102	8x22.3	8x22.3	178	254	127	-	65	345	280	125	95	M12	140	181	-	18
040-095	127	102	8x22.3	8x19	127	102	8x22.3	8x22.3	229	279	140	-	80	400	315	160	120	M16	181	226	-	25
040-110	127	102	8x22.3	8x19	127	102	8x22.3	8x22.3	229	318	140	-	80	400	315	160	120	M16	153	226	-	20
040-135	127	102	8x22.3	8x19	127	102	8x22.3	8x22.3	254	318	140	-	80	400	315	160	120	M16	206	244	-	23
040-150	127	102	8x22.3	8x19	127	102	8x22.3	8x22.3	279	356	140	-	100	500	400	200	150	M20	265	298	-	18
050-070	152	127	8x22.3	8x22.3	152	127	12x22.3	8x22.3	203	279	127	-	80	360	280	160	120	M16	162	215	-	18
050-095	152	127	8x22.3	8x22.3	152	127	12x22.3	8x22.3	254	356	140	-	80	400	315	160	120	M16	183	236	-	28
050-110	152	127	8x22.3	8x22.3	152	127	12x22.3	8x22.3	254	356	140	-	86	406	315	160	120	M16	207	254	-	23
050-135	152	127	8x22.3	8x22.3	152	127	12x22.3	8x22.3	279	356	140	-	100	500	400	200	150	M20	223	270	-	23
050-150	152	127	8x22.3	8x22.3	152	127	12x22.3	8x22.3	318	400	140	-	100	500	400	200	150	M20	277	326	-	25
060-095	203	152	8x22.3	8x22.3	203	152	12x25.4	12x22.3	279	375	159	-	100	500	400	200	150	M20	230	300	-	18
060-110	203	152	8x22.3	8x22.3	203	152	12x25.4	12x22.3	279	375	159	-	100	500	400	200	150	M20	223	287	-	23
060-135	203	152	8x22.3	8x22.3	203	152	12x25.4	12x22.3	279	400	159	-	100	550	450	200	150	M20	255	314	-	23
060-150	203	152	8x22.3	8x22.3	203	152	12x25.4	12x22.3	318	451	159	-	100	550	450	200	150	M20	288	356	-	23
080-135	254	203	12x25.4	8x22.3	254	203	16x28.4	12x25.4	349	356	159	-	125	625	500	200	150	M20	314	438	265	28
080-150	254	203	12x25.4	8x22.3	254	203	16x28.4	12x25.4	400	400	184	-	125	625	500	200	150	M20	361	463	290	28
100-150	305	254	12x25.4	12x25.4	305	254	16x31.7	16x28.4	451	502	165	35	125	625	500	200	150	M20	367	498	295	23



## Dimensions for NBS pumps with TEFC motors and support rails

Dimensions in inch.

Dimensions for pumps with TEFC motor and support rails [inch]																						
Pump size	Pole	P2 [hp]	Actual impeller size [inch]	TEFC motor						Support rail under pump						Support rail under motor						
				LP	Q	D	E	T	AB	AG	L7	L8	B7	H5	H7	HG3	L4	L6	B4	H6	HG1	
012-070	3	4.29	14.64	9.54	4.5	3.75	8.69	5.88	15.5	7.75	3.13	11.42	1.75	7	0.2	13.75	12.25	10.45	2.5	0.2		
		7.5	4.92	14.64	9.54	4.5	3.75	8.69	5.88	15.5	7.75	3.13	11.42	1.75	7	0.2	13.75	12.25	10.45	2.5	0.2	
		7.5	5.71	14.64	10.42	5.25	4.25	10.25	7.38	17.38	7.75	3.13	11.42	1.75	7	0.2	16.66	15.16	11.45	1.75	0.2	
	2	7.5	5.87	14.64	10.42	5.25	4.25	10.25	7.38	17.38	7.75	3.13	11.42	1.75	7	0.2	16.66	15.16	11.45	1.75	0.2	
		15	6.10	14.64	10.42	5.25	4.25	10.25	7.38	17.38	7.75	3.13	11.42	1.75	7	0.2	16.66	15.16	11.45	1.75	0.2	
		15	6.42	14.64	10.24	6.25	5	12.88	9.63	19.5	7.75	3.13	11.42	1.75	7	0.2	20.25	18.75	11.97	0.75	0.38	
	4	15	6.97	14.64	10.24	6.25	5	12.88	9.63	19.5	7.75	3.13	11.42	1.75	7	0.2	20.25	18.75	11.97	0.75	0.38	
		1	5.00	13.34	7.81	3.5	2.75	6.88	5.25	11.25	7.75	3.13	10.43	1	6.25	0.5	13.29	11.79	8.45	2.75	0.2	
		1	5.56	13.34	7.81	3.5	2.75	6.88	5.25	11.25	7.75	3.13	10.43	1	6.25	0.5	13.29	11.79	8.45	2.75	0.2	
	015-070	4	1	6.10	13.34	7.81	3.5	2.75	6.88	5.25	11.25	7.75	3.13	10.43	1	6.25	0.5	13.29	11.79	8.45	2.75	0.2
			1.5	6.97	13.34	7.81	3.5	2.75	6.88	5.25	11.25	7.75	3.13	10.43	1	6.25	0.5	13.29	11.79	8.45	2.75	0.2
			5	4.49	14.64	9.54	4.5	3.75	8.69	5.88	15.5	7.75	3.13	11.42	1.75	7	0.2	13.75	12.25	10.45	2.5	0.2
2		7.5	5.04	14.64	10.42	5.25	4.25	10.25	7.38	17.38	7.75	3.13	11.42	1.75	7	0.2	16.66	15.16	11.45	1.75	0.2	
		10	5.59	14.64	10.42	5.25	4.25	10.25	7.38	17.38	7.75	3.13	11.42	1.75	7	0.2	16.66	15.16	11.45	1.75	0.2	
		15	6.30	14.64	10.24	6.25	5	12.88	9.63	19.5	7.75	3.13	11.42	1.75	7	0.2	20.25	18.75	11.97	0.75	0.38	
4		20	6.93	14.64	10.24	6.25	5	12.88	9.63	19.5	7.75	3.13	11.42	1.75	7	0.2	20.25	18.75	11.97	0.75	0.38	
		1	4.65	13.34	7.81	3.5	2.75	6.88	5.25	11.25	7.75	3.13	10.43	1	6.25	0.5	13.29	11.79	8.45	2.75	0.2	
		1	5.12	13.34	7.81	3.5	2.75	6.88	5.25	11.25	7.75	3.13	10.43	1	6.25	0.5	13.29	11.79	8.45	2.75	0.2	
015-090		4	1.5	5.91	13.34	7.81	3.5	2.75	6.88	5.25	11.25	7.75	3.13	10.43	1	6.25	0.5	13.29	11.79	8.45	2.75	0.2
			2	6.54	13.34	7.81	3.5	2.75	6.88	5.25	11.25	7.75	3.13	10.43	1	6.25	0.5	13.29	11.79	8.45	2.75	0.2
			3	6.93	14.64	9.54	4.5	3.75	8.69	5.88	15.5	7.75	3.13	11.42	1.75	7	0.2	13.75	12.25	10.45	2.5	0.2
	2	15	7.09	17.13	12.11	6.25	5	12.88	9.63	19.5	8.75	3.63	12.8	1	8	0.5	20	18.5	12.95	1.75	0.2	
		20	7.80	17.13	12.11	6.25	5	12.88	9.63	19.5	8.75	3.63	12.8	1	8	0.5	20	18.5	12.95	1.75	0.2	
		25	8.27	15.44	10.17	7	5.5	14.63	13.13	21.75	8.75	3.63	12.8	1	8	0.5	22.25	20.75	13.95	1	0.5	
	4	30	8.82	15.44	10.17	7	5.5	14.63	13.13	21.75	8.75	3.63	12.8	1	8	0.5	22.25	20.75	13.95	1	0.5	
		40	9.84	16.34	11.38	8	6.25	16.5	14.13	25.25	9	3.75	13.78	2	9	0.2	23.5	22	15.45	1	0.5	
		1.5	6.69	14.22	9.08	3.5	2.75	6.88	5.25	11.25	-	-	-	-	-	-	14.29	12.79	8.45	3.5	0.2	
	015-095	4	2	7.24	14.22	9.08	3.5	2.75	6.88	5.25	11.25	-	-	-	-	-	-	14.29	12.79	8.45	3.5	0.2
			3	8.11	15.52	10.81	4.5	3.75	8.69	5.88	15.5	-	-	-	-	-	-	14.66	13.16	10.45	2.5	0.2
			5	9.84	15.52	10.81	4.5	3.75	8.69	5.88	15.5	-	-	-	-	-	-	14.66	13.16	10.45	2.5	0.2
2		15	6.46	17.13	12.11	6.25	5	12.88	9.63	19.5	8.75	3.63	12.8	1	8	0.5	20	18.5	12.95	1.75	0.2	
		20	7.01	17.13	12.11	6.25	5	12.88	9.63	19.5	8.75	3.63	12.8	1	8	0.5	20	18.5	12.95	1.75	0.2	
		25	7.48	15.44	10.17	7	5.5	14.63	13.13	21.75	8.75	3.63	12.8	1	8	0.5	22.25	20.75	13.95	1	0.5	
4		30	7.87	15.44	10.17	7	5.5	14.63	13.13	21.75	8.75	3.63	12.8	1	8	0.5	22.25	20.75	13.95	1	0.5	
		40	8.82	16.34	11.38	8	6.25	16.5	14.13	25.25	9	3.75	13.78	2	9	0.2	23.5	22	15.45	1	0.5	
		50	9.69	16.34	11.38	8	6.25	16.5	14.13	25.25	9	3.75	13.78	2	9	0.2	23.5	22	15.45	1	0.5	
4		2	6.54	14.22	9.08	3.5	2.75	6.88	5.25	11.25	-	-	-	-	-	-	14.29	12.79	8.45	3.5	0.2	
		3	7.32	15.52	10.81	4.5	3.75	8.69	5.88	15.5	-	-	-	-	-	-	14.66	13.16	10.45	2.5	0.2	
		5	8.82	15.52	10.81	4.5	3.75	8.69	5.88	15.5	-	-	-	-	-	-	14.66	13.16	10.45	2.5	0.2	
	7.5	9.84	15.52	11.69	5.25	4.25	10.25	7.38	17.38	-	-	-	-	-	-	16.66	15.16	11.45	1.75	0.2		

Dimensions for pumps with TEFC motor and support rails [inch]																						
Pump size	Pole	P2 [hp]	Actual impeller size [inch]	TEFC motor						Support rail under pump						Support rail under motor						
				LP	Q	D	E	T	AB	AG	L7	L8	B7	H5	H7	HG3	L4	L6	B4	H6	HG1	
020-095	2	15	5.75	17.54	12.52	6.25	5	12.88	9.63	19.5	8.75	3.63	12.8	1	8	0.5	20	18.5	12.95	1.75	0.2	
		20	6.30	17.54	12.52	6.25	5	12.88	9.63	19.5	8.75	3.63	12.8	1	8	0.5	20	18.5	12.95	1.75	0.2	
		25	6.77	15.85	10.58	7	5.5	14.63	13.13	21.75	8.75	3.63	12.8	1	8	0.5	22.25	20.75	13.95	1	0.5	
		30	7.17	15.85	10.58	7	5.5	14.63	13.13	21.75	8.75	3.63	12.8	1	8	0.5	22.25	20.75	13.95	1	0.5	
	4	40	8.03	16.76	11.8	8	6.25	16.5	14.13	25.25	9	3.75	13.78	2	9	0.2	23.5	22	15.45	1	0.5	
		50	8.58	16.76	11.8	8	6.25	16.5	14.13	25.25	9	3.75	13.78	2	9	0.2	23.5	22	15.45	1	0.5	
		60	8.90 <sup>27)</sup>	16.76	12.3	9	7	18.5	18.06	27.75	9	3.75	13.78	3	10	0.2	24.5	23	16.95	1	0.5	
		60	9.45 <sup>28)</sup>	16.76	12.3	9	7	18.5	18.06	27.75	9	3.75	13.78	3	10	0.2	24.5	23	16.95	1	0.5	
020-110	4	2	5.83	14.22	9.08	3.5	2.75	6.88	5.25	11.25	-	-	-	-	-	-	14.29	12.79	8.45	3.5	0.2	
		3	6.61	15.52	10.81	4.5	3.75	8.69	5.88	15.5	-	-	-	-	-	-	-	14.66	13.16	10.45	2.5	0.2
		5	8.11	15.52	10.81	4.5	3.75	8.69	5.88	15.5	-	-	-	-	-	-	-	14.66	13.16	10.45	2.5	0.2
	4	7.5	9.45	15.52	11.69	5.25	4.25	10.25	7.38	17.38	-	-	-	-	-	-	-	16.66	15.16	11.45	1.75	0.2
		5	8.11	15.52	10.81	4.5	3.75	8.69	5.88	15.5	-	-	-	-	-	-	-	14.66	13.16	10.45	2.5	0.2
020-135	4	7.5	8.98	15.52	11.69	5.25	4.25	10.25	7.38	17.38	-	-	-	-	-	-	16.66	15.16	11.45	1.75	0.2	
		10	9.92	15.52	11.69	5.25	4.25	10.25	7.38	17.38	-	-	-	-	-	-	16.66	15.16	11.45	1.75	0.2	
	4	15	10.31	15.52	11.51	6.25	5	12.88	9.63	19.5	-	-	-	-	-	-	20.25	18.75	11.97	0.75	0.38	
		7.5	9.29	17.56	12.73	5.25	4.25	10.25	7.38	17.38	-	-	-	-	-	-	16.66	15.16	11.45	3.75	0.2	
025-070	4	10	10.16	17.56	12.73	5.25	4.25	10.25	7.38	17.38	-	-	-	-	-	-	16.66	15.16	11.45	3.75	0.2	
		15	11.42	17.56	13.3	6.25	5	12.88	9.63	19.5	-	-	-	-	-	-	20.5	19	12.95	2.75	0.2	
		20	12.52	17.56	13.3	6.25	5	12.88	9.63	19.5	-	-	-	-	-	-	20.5	19	12.95	2.75	0.2	
	2	25	13.39-13.23	18.94	15.06	7	5.5	14.63	13.13	23.38	-	-	-	-	-	-	21.75	20.25	15.17	2	0.31	
		7.5	4.57	15.52	9.93	5.25	4.25	10.25	7.38	17.38	8.75	3.63	11.3	0.75	7	0.38	16.66	15.16	11.45	1.75	0.2	
025-095	2	10	4.96	15.52	9.93	5.25	4.25	10.25	7.38	17.38	8.75	3.63	11.3	0.75	7	0.38	16.66	15.16	11.45	1.75	0.2	
		15	5.67	17.13	9.75	6.25	5	12.88	9.63	19.5	8.75	3.63	11.3	0.75	7	0.38	20.25	18.75	11.97	0.75	0.38	
		20	6.30	17.13	9.75	6.25	5	12.88	9.63	19.5	8.75	3.63	11.3	0.75	7	0.38	20.25	18.75	11.97	0.75	0.38	
		25	6.61	15.44	10.05	7	5.5	14.63	13.13	21.75	9	3.75	12.28	1.75	8	0.2	22.25	20.75	13.95	1	0.5	
	4	30	6.77	15.44	10.05	7	5.5	14.63	13.13	21.75	9	3.75	12.28	1.75	8	0.2	22.25	20.75	13.95	1	0.5	
		1	4.65	14.22	9.08	3.5	2.75	6.88	5.25	11.25	-	-	-	-	-	-	13.29	11.79	8.45	2.75	0.2	
		1.5	5.28	14.22	9.08	3.5	2.75	6.88	5.25	11.25	-	-	-	-	-	-	13.29	11.79	8.45	2.75	0.2	
		2	5.83	14.22	9.08	3.5	2.75	6.88	5.25	11.25	-	-	-	-	-	-	13.29	11.79	8.45	2.75	0.2	
025-135	4	3	6.61	15.52	9.05	4.5	3.75	8.69	5.88	15.5	8.75	3.63	11.3	0.75	7	0.38	14.66	13.16	10.45	2.5	0.2	
		5	6.77	15.52	9.05	4.5	3.75	8.69	5.88	15.5	8.75	3.63	11.3	0.75	7	0.38	14.66	13.16	10.45	2.5	0.2	
		25	5.98	15.85	11.92	7	5.5	14.63	13.13	21.75	-	-	-	-	-	-	22.25	20.75	13.95	1	0.5	
	2	30	6.30	15.85	11.92	7	5.5	14.63	13.13	21.75	-	-	-	-	-	-	22.25	20.75	13.95	1	0.5	
		40	7.17	16.76	11.05	8	6.25	16.5	14.13	25.25	10.5	4.5	14.96	1	9	0.5	23.5	22	15.45	1	0.5	
		50	7.80	16.76	11.05	8	6.25	16.5	14.13	25.25	10.5	4.5	14.96	1	9	0.5	23.5	22	15.45	1	0.5	
		60	8.43	16.76	11.55	9	7	18.5	18.06	27.75	10.5	4.5	15.94	2	10	0.2	24.5	23	16.95	1	0.5	
		75	9.37 <sup>27)</sup>	16.76	11.55	9	7	18.5	18.06	27.75	10.5	4.5	15.94	2	10	0.2	24.5	23	16.95	1	0.5	
		75	9.53 <sup>28)</sup>	16.76	11.55	9	7	18.5	18.06	27.75	10.5	4.5	15.94	2	10	0.2	24.5	23	16.95	1	0.5	
025-170	4	3	5.98	15.52	10.4	4.5	3.75	8.69	5.88	15.5	-	-	-	-	-	-	14.66	13.16	10.45	3.5	0.2	
		5	7.17	15.52	10.4	4.5	3.75	8.69	5.88	15.5	-	-	-	-	-	-	14.66	13.16	10.45	3.5	0.2	
		7.5	8.43	15.52	11.28	5.25	4.25	10.25	7.38	17.38	-	-	-	-	-	-	16.66	15.16	11.45	2.75	0.2	
	6	10	9.53	15.52	11.28	5.25	4.25	10.25	7.38	17.38	-	-	-	-	-	-	16.66	15.16	11.45	2.75	0.2	
		1	6.06	14.22	8.66	3.5	2.75	6.88	5.25	11.25	-	-	-	-	-	-	14.5	13	8.45	4.5	0.2	
		1.5	7.17	15.52	10.4	4.5	3.75	8.69	5.88	15.5	-	-	-	-	-	-	14.66	13.16	10.45	3.5	0.2	
		2	8.19	15.52	10.4	4.5	3.75	8.69	5.88	15.5	-	-	-	-	-	-	14.66	13.16	10.45	3.5	0.2	
3	9.53	15.52	11.28	5.25	4.25	10.25	7.38	17.38	-	-	-	-	-	-	16.66	15.16	11.45	2.75	0.2			

Dimensions for pumps with TEFC motor and support rails [inch]																					
Pump size	Pole	P2 [hp]	Actual impeller size [inch]	TEFC motor						Support rail under pump						Support rail under motor					
				LP	Q	D	E	T	AB	AG	L7	L8	B7	H5	H7	HG3	L4	L6	B4	H6	HG1
025-110	4	7.5	8.58	17.56	12.24	5.25	4.25	10.25	7.38	17.38	-	-	-	-	-	-	16.66	15.16	11.45	2.75	0.2
		10	9.45	17.56	12.24	5.25	4.25	10.25	7.38	17.38	-	-	-	-	-	-	16.66	15.16	11.45	2.75	0.2
	6	15	11.02	17.56	12.81	6.25	5	12.88	9.63	19.5	-	-	-	-	-	-	20	18.5	12.95	1.75	0.2
		2	8.43	17.56	11.36	4.5	3.75	8.69	5.88	15.5	-	-	-	-	-	-	14.66	13.16	10.45	3.5	0.2
		3	9.61	17.56	12.24	5.25	4.25	10.25	7.38	17.38	-	-	-	-	-	-	16.66	15.16	11.45	2.75	0.2
030-070	2	5	11.02	17.56	12.24	5.25	4.25	10.25	7.38	17.38	-	-	-	-	-	-	16.66	15.16	11.45	2.75	0.2
		15	5.04	17.13	9.75	6.25	5	12.88	9.63	19.5	8.75	3.63	11.3	0.75	7	0.38	20.25	18.75	11.97	0.75	0.38
	4	20	5.59	17.13	9.75	6.25	5	12.88	9.63	19.5	8.75	3.63	11.3	0.75	7	0.38	20.25	18.75	11.97	0.75	0.38
		25	5.83	15.44	10.05	7	5.5	14.63	13.13	21.75	9	3.75	12.28	1.75	8	0.2	22.25	20.75	13.95	1	0.5
		30	6.30	15.44	10.05	7	5.5	14.63	13.13	21.75	9	3.75	12.28	1.75	8	0.2	22.25	20.75	13.95	1	0.5
		40	6.85	16.34	11.38	8	6.25	16.5	14.13	25.25	9	3.75	12.28	2.75	9	0.2	23.5	22	15.45	1	0.5
		1.5	4.72	14.22	9.08	3.5	2.75	6.88	5.25	11.25	-	-	-	-	-	-	13.29	11.79	8.45	2.75	0.2
		2	5.20	14.22	9.08	3.5	2.75	6.88	5.25	11.25	-	-	-	-	-	-	13.29	11.79	8.45	2.75	0.2
		3	5.83	15.52	9.05	4.5	3.75	8.69	5.88	15.5	8.75	3.63	11.3	0.75	7	0.38	14.66	13.16	10.45	2.5	0.2
		5	6.85	15.52	9.05	4.5	3.75	8.69	5.88	15.5	8.75	3.63	11.3	0.75	7	0.38	14.66	13.16	10.45	2.5	0.2
030-095	2	40	6.10	18.54	11.83	8	6.25	16.5	14.13	25.25	10.5	4.5	16.34	1	9	0.5	23.5	22	15.45	1	0.5
		50	6.50	18.54	11.83	8	6.25	16.5	14.13	25.25	10.5	4.5	16.34	1	9	0.5	23.5	22	15.45	1	0.5
	4	60	6.89	18.54	12.33	9	7	18.5	18.06	27.75	10.5	4.5	17.32	2	10	0.2	24.5	23	16.95	1	0.5
		75	7.36	18.54	12.33	9	7	18.5	18.06	27.75	10.5	4.5	17.32	2	10	0.2	24.5	23	16.95	1	0.5
		100	8.07	18.54	13.33	10	8	21.31	19.31	31	10	4.25	17.32	3	11	0.2	27.5	26	19.94	1	0.5
		125	8.86	19.06	13.51	11	9	24.24	22.68	36.63	10	4.25	16.34	4	12	0.2	29.5	28	21.94	1	0.5
		5	6.10	17.3	11.1	4.5	3.75	8.69	5.88	15.5	-	-	-	-	-	-	14.66	13.16	10.45	3.5	0.2
		7.5	6.73	17.3	11.98	5.25	4.25	10.25	7.38	17.38	-	-	-	-	-	-	16.66	15.16	11.45	2.75	0.2
		10	7.52	17.3	11.98	5.25	4.25	10.25	7.38	17.38	-	-	-	-	-	-	16.66	15.16	11.45	2.75	0.2
		15	8.86	17.3	12.55	6.25	5	12.88	9.63	19.5	-	-	-	-	-	-	20	18.5	12.95	1.75	0.2
030-110	4	1.5	6.02	17.3	11.1	4.5	3.75	8.69	5.88	15.5	-	-	-	-	-	-	14.66	13.16	10.45	3.5	0.2
		2	6.57	17.3	11.1	4.5	3.75	8.69	5.88	15.5	-	-	-	-	-	-	14.66	13.16	10.45	3.5	0.2
	6	3	7.52	17.3	11.98	5.25	4.25	10.25	7.38	17.38	-	-	-	-	-	-	16.66	15.16	11.45	2.75	0.2
		5	8.86	17.3	11.98	5.25	4.25	10.25	7.38	17.38	-	-	-	-	-	-	16.66	15.16	11.45	2.75	0.2
		10	8.50-8.19	17.56	12.24	5.25	4.25	10.25	7.38	17.38	-	-	-	-	-	-	16.66	15.16	11.45	2.75	0.2
		15	9.76-9.45	17.56	12.81	6.25	5	12.88	9.63	19.5	-	-	-	-	-	-	20	18.5	12.95	1.75	0.2
		20	10.94-10.63	17.56	12.81	6.25	5	12.88	9.63	19.5	-	-	-	-	-	-	20	18.5	12.95	1.75	0.2
		3	8.58-8.27	17.56	12.24	5.25	4.25	10.25	7.38	17.38	-	-	-	-	-	-	16.66	15.16	11.45	2.75	0.2
		5	10.47-10.16	17.56	12.24	5.25	4.25	10.25	7.38	17.38	-	-	-	-	-	-	16.66	15.16	11.45	2.75	0.2
		7.5	10.94-10.63	17.56	12.81	6.25	5	12.88	9.63	19.5	-	-	-	-	-	-	20	18.5	12.95	1.75	0.2
030-135	4	15	8.98	17.56	12.81	6.25	5	12.88	9.63	19.5	-	-	-	-	-	-	21	19.5	12.95	3.75	0.2
		20	9.92	17.56	12.81	6.25	5	12.88	9.63	19.5	-	-	-	-	-	-	21	19.5	12.95	3.75	0.2
	6	25	10.63	18.94	14.57	7	5.5	14.63	13.13	23.38	-	-	-	-	-	-	22.25	20.75	15.17	3	0.31
		30	11.26	18.94	14.57	7	5.5	14.63	13.13	23.38	-	-	-	-	-	-	22.25	20.75	15.17	3	0.31
		40	12.91	19.88	15.95	8	6.25	16.5	14.13	25.25	-	-	-	-	-	-	23.25	21.75	16.67	2	0.31
		5	8.98	17.56	12.24	5.25	4.25	10.25	7.38	17.38	-	-	-	-	-	-	17.5	16	11.45	4.75	0.2
		7.5	10.55	17.56	12.81	6.25	5	12.88	9.63	19.5	-	-	-	-	-	-	21	19.5	12.95	3.75	0.2
		10	11.73	17.56	12.81	6.25	5	12.88	9.63	19.5	-	-	-	-	-	-	21	19.5	12.95	3.75	0.2
		15	12.91	18.94	14.57	7	5.5	14.63	13.13	23.38	-	-	-	-	-	-	22.25	20.75	15.17	3	0.31

Dimensions for pumps with TEFC motor and support rails [inch]																				
Pump size	Pole	P2 [hp]	Actual impeller size [inch]	TEFC motor						Support rail under pump						Support rail under motor				
				LP	Q	D	E	T	AB	AG	L7	L8	B7	H5	H7	HG3	L4	L6	B4	H6
2	20	5.43-4.80	18.13	12.11	6.25	5	12.88	9.63	19.5	8.75	3.63	13.98	1	8	0.5	20	18.5	12.95	1.75	0.2
	25	5.51	16.44	10.17	7	5.5	14.63	13.13	21.75	8.75	3.63	13.98	1	8	0.5	22.25	20.75	13.95	1	0.5
	30	5.75	16.44	10.17	7	5.5	14.63	13.13	21.75	8.75	3.63	13.98	1	8	0.5	22.25	20.75	13.95	1	0.5
	40	6.30	17.34	11.38	8	6.25	16.5	14.13	25.25	9	3.75	14.96	2	9	0.2	23.5	22	15.45	1	0.5
	50	6.77	17.34	11.38	8	6.25	16.5	14.13	25.25	9	3.75	14.96	2	9	0.2	23.5	22	15.45	1	0.5
040-070	2	5.12-4.33	15.22	9.08	3.5	2.75	6.88	5.25	11.25	-	-	-	-	-	-	14.29	12.79	8.45	3.5	0.2
	3	5.43	16.52	10.81	4.5	3.75	8.69	5.88	15.5	-	-	-	-	-	-	14.66	13.16	10.45	2.5	0.2
	5	6.30	16.52	10.81	4.5	3.75	8.69	5.88	15.5	-	-	-	-	-	-	14.66	13.16	10.45	2.5	0.2
	7.5	6.85	16.52	11.69	5.25	4.25	10.25	7.38	17.38	-	-	-	-	-	-	16.66	15.16	11.45	1.75	0.2
	0.75	5.12-4.80	15.22	9.08	3.5	2.75	6.88	5.25	11.25	-	-	-	-	-	-	14.29	12.79	8.45	3.5	0.2
6	1	5.51	15.22	9.08	3.5	2.75	6.88	5.25	11.25	-	-	-	-	-	-	14.29	12.79	8.45	3.5	0.2
	1.5	6.14	16.52	10.81	4.5	3.75	8.69	5.88	15.5	-	-	-	-	-	-	14.66	13.16	10.45	2.5	0.2
	2	6.85	16.52	10.81	4.5	3.75	8.69	5.88	15.5	-	-	-	-	-	-	14.66	13.16	10.45	2.5	0.2
2	60	6.46	19.04	12.33	9	7	18.5	18.06	27.75	10.5	4.5	16.34	1	10	0.5	24.5	23	16.95	1	0.5
	75	6.93	19.04	12.33	9	7	18.5	18.06	27.75	10.5	4.5	16.34	1	10	0.5	24.5	23	16.95	1	0.5
	100	7.72	19.04	13.08	10	8	21.31	19.31	31	10.5	4.5	17.32	2	11	0.2	27.5	26	19.94	1	0.5
	125	8.35	19.56	13.51	11	9	24.24	22.68	36.63	10	4.25	17.32	3	12	0.2	29.5	28	21.94	1	0.5
040-095	7.5	6.38	17.8	11.98	5.25	4.25	10.25	7.38	17.38	-	-	-	-	-	-	16.66	15.16	11.45	3.75	0.2
	10	7.09	17.8	11.98	5.25	4.25	10.25	7.38	17.38	-	-	-	-	-	-	16.66	15.16	11.45	3.75	0.2
	15	8.35	17.8	12.55	6.25	5	12.88	9.63	19.5	-	-	-	-	-	-	20.5	19	12.95	2.75	0.2
	20	9.37	17.8	12.55	6.25	5	12.88	9.63	19.5	-	-	-	-	-	-	20.5	19	12.95	2.75	0.2
	2	6.30	17.8	11.1	4.5	3.75	8.69	5.88	15.5	-	-	-	-	-	-	15.25	13.75	10.45	4.5	0.2
6	3	7.09	17.8	11.98	5.25	4.25	10.25	7.38	17.38	-	-	-	-	-	-	16.66	15.16	11.45	3.75	0.2
	5	8.98	17.8	11.98	5.25	4.25	10.25	7.38	17.38	-	-	-	-	-	-	16.66	15.16	11.45	3.75	0.2
	7.5	9.37	17.8	12.55	6.25	5	12.88	9.63	19.5	-	-	-	-	-	-	20.5	19	12.95	2.75	0.2
040-110	15	8.11	18.06	12.81	6.25	5	12.88	9.63	19.5	-	-	-	-	-	-	20.5	19	12.95	2.75	0.2
	20	8.74	18.06	12.81	6.25	5	12.88	9.63	19.5	-	-	-	-	-	-	20.5	19	12.95	2.75	0.2
	25	9.45	19.44	14.57	7	5.5	14.63	13.13	23.38	-	-	-	-	-	-	21.75	20.25	15.17	2	0.31
	30	10.08	19.44	14.57	7	5.5	14.63	13.13	23.38	-	-	-	-	-	-	21.75	20.25	15.17	2	0.31
	3	7.17	18.06	12.24	5.25	4.25	10.25	7.38	17.38	-	-	-	-	-	-	16.66	15.16	11.45	3.75	0.2
6	5	8.35	18.06	12.24	5.25	4.25	10.25	7.38	17.38	-	-	-	-	-	-	16.66	15.16	11.45	3.75	0.2
	7.5	9.37	18.06	12.81	6.25	5	12.88	9.63	19.5	-	-	-	-	-	-	20.5	19	12.95	2.75	0.2
	10	10.08	18.06	12.81	6.25	5	12.88	9.63	19.5	-	-	-	-	-	-	20.5	19	12.95	2.75	0.2
040-135	20	9.29	18.06	12.88	6.25	5	12.88	9.63	19.5	-	-	-	-	-	-	21	19.5	12.95	3.75	0.2
	25	10.24	19.44	14.64	7	5.5	14.63	13.13	23.38	-	-	-	-	-	-	22.25	20.75	15.17	3	0.31
	30	10.94	19.44	14.64	7	5.5	14.63	13.13	23.38	-	-	-	-	-	-	22.25	20.75	15.17	3	0.31
	40	11.81	20.38	16.02	8	6.25	16.5	14.13	25.25	-	-	-	-	-	-	23.25	21.75	16.67	2	0.31
	50	12.83	20.38	16.02	8	6.25	16.5	14.13	25.25	-	-	-	-	-	-	23.25	21.75	16.67	2	0.31
6	5	8.74	18.06	12.32	5.25	4.25	10.25	7.38	17.38	-	-	-	-	-	-	17.5	16	11.45	4.75	0.2
	7.5	10.16	18.06	12.88	6.25	5	12.88	9.63	19.5	-	-	-	-	-	-	21	19.5	12.95	3.75	0.2
	10	11.18	18.06	12.88	6.25	5	12.88	9.63	19.5	-	-	-	-	-	-	21	19.5	12.95	3.75	0.2
	15	12.60	19.44	14.64	7	5.5	14.63	13.13	23.38	-	-	-	-	-	-	22.25	20.75	15.17	3	0.31

Dimensions for pumps with TEFC motor and support rails [inch]																					
Pump size	Pole	Actual impeller size P2 [hp] [inch]	TEFC motor							Support rail under pump						Support rail under motor					
			LP	Q	D	E	T	AB	AG	L7	L8	B7	H5	H7	HG3	L4	L6	B4	H6	HG1	
040-150	4	50	12.21	21.52	16.49	8	6.25	16.5	14.13	25.25	-	-	-	-	-	-	24.25	22.75	16.67	3	0.31
		60	12.91	21.52	17.12	9	7	18.5	18.06	27.63	-	-	-	-	-	-	24.5	23	18.17	2	0.31
		75	13.86	21.52	17.12	9	7	18.5	18.06	27.75	-	-	-	-	-	-	24.5	23	18.17	2	0.31
		100	15.20	23.02	18.61	10	8	21.31	19.31	31	-	-	-	-	-	-	27.5	26	19.94	1	0.5
		125	16.06	25.03	18.23	11	9	24.24	22.68	36.63	11.5	5	19.69	1	12	0.5	29.5	28	21.94	1	0.5
	6	150	16.77	25.03	18.23	11	9	24.24	22.68	36.63	11.5	5	19.69	1	12	0.5	29.5	28	21.94	1	0.5
		15	11.97	20.85	15.38	7	5.5	14.63	13.13	23.38	-	-	-	-	-	-	22.75	21.25	15.17	4	0.31
		20	13.39	20.85	15.38	7	5.5	14.63	13.13	23.38	-	-	-	-	-	-	22.75	21.25	15.17	4	0.31
		25	14.49	21.52	16.49	8	6.25	16.5	14.13	25.25	-	-	-	-	-	-	24.25	22.75	16.67	3	0.31
		30	15.28	21.52	16.49	8	6.25	16.5	14.13	25.25	-	-	-	-	-	-	24.25	22.75	16.67	3	0.31
2	40	16.69	21.52	17.12	9	7	18.5	18.06	27.63	-	-	-	-	-	-	24.5	23	18.17	2	0.31	
	25	5.59-4.49	16.44	11.44	7	5.5	14.63	13.13	21.75	-	-	-	-	-	-	22.25	20.75	13.95	1	0.5	
	30	5.98-4.88	16.44	11.44	7	5.5	14.63	13.13	21.75	-	-	-	-	-	-	22.25	20.75	13.95	1	0.5	
	40	6.06	17.34	10.63	8	6.25	16.5	14.13	25.25	10.5	4.5	14.96	1	9	0.5	23.5	22	15.45	1	0.5	
	50	6.46	17.34	10.63	8	6.25	16.5	14.13	25.25	10.5	4.5	14.96	1	9	0	23.5	22	15.45	1	0.5	
	60	6.77	17.34	11.13	9	7	18.5	18.06	27.75	10.5	4.5	15.94	2	10	0.2	24.5	23	16.95	1	0.5	
	75	6.93	17.34	11.13	9	7	24.24	18.06	27.75	10.5	4.5	15.94	2	10	0.2	24.5	23	16.95	1	0.5	
4	3	5.43-4.33	16.52	10.32	4.5	3.75	8.69	5.88	15.5	-	-	-	-	-	-	14.66	13.16	10.45	3.5	0.2	
	5	6.06	16.52	10.32	4.5	3.75	24.24	5.88	15.5	-	-	-	-	-	-	14.66	13.16	10.45	3.5	0.2	
	7.5	6.61	16.52	11.2	5.25	4.25	10.25	7.38	17.38	-	-	-	-	-	-	16.66	15.16	11.45	2.75	0.2	
	10	6.93	16.52	11.2	5.25	4.25	10.25	7.38	17.38	-	-	-	-	-	-	16.66	15.16	11.45	2.75	0.2	
	0.75	5.28-4.17	15.22	8.59	3.5	2.75	6.88	5.25	11.25	-	-	-	-	-	-	14.5	13	8.45	4.5	0.2	
6	1	5.91-4.17	15.22	8.59	3.5	2.75	6.88	5.25	11.25	-	-	-	-	-	-	14.5	13	8.45	4.5	0.2	
	1.5	6.06	16.52	10.32	4.5	3.75	8.69	5.88	15.5	-	-	-	-	-	-	14.66	13.16	10.45	3.5	0.2	
	2	6.61	16.52	10.32	4.5	3.75	24.24	5.88	15.5	-	-	-	-	-	-	14.66	13.16	10.45	3.5	0.2	
	3	6.93	16.52	11.2	5.25	4.25	10.25	7.38	17.38	-	-	-	-	-	-	16.66	15.16	11.45	2.75	0.2	
4	10	6.85-6.06	19.83	14.01	5.25	4.25	10.25	7.38	17.38	-	-	-	-	-	-	17.5	16	11.45	4.75	0.2	
	15	7.4	19.83	14.58	6.25	5	12.88	9.63	19.5	-	-	-	-	-	-	21	19.5	12.95	3.75	0.2	
	20	8.19	19.83	14.58	6.25	5	12.88	9.63	19.5	-	-	-	-	-	-	21	19.5	12.95	3.75	0.2	
	25	8.74	20.34	15.47	7	5.5	14.63	13.13	23.38	-	-	-	-	-	-	22.25	20.75	15.17	3	0.31	
	30	9.13	20.34	15.47	7	5.5	14.63	13.13	23.38	-	-	-	-	-	-	22.25	20.75	15.17	3	0.31	
	3	6.85-6.06	19.83	14.01	5.25	4.25	10.25	7.38	17.38	-	-	-	-	-	-	17.5	16	11.45	3	0.2	
	5	7.72	19.83	14.01	5.25	4.25	10.25	7.38	17.38	-	-	-	-	-	-	17.5	16	11.45	4.75	0.2	
6	7.5	8.74	19.83	14.58	6.25	5	12.88	9.63	19.5	-	-	-	-	-	-	21	19.5	12.95	3.75	0.2	
	10	9.13	19.83	14.58	6.25	5	12.88	9.63	19.5	-	-	-	-	-	-	21	19.5	12.95	3.75	0.2	
	20	8.35	18.06	12.81	6.25	5	12.88	9.63	19.5	-	-	-	-	-	-	21	19.5	12.95	3.75	0.2	
	25	9.06	19.44	14.57	7	5.5	14.63	13.13	23.38	-	-	-	-	-	-	22.25	20.75	15.17	3	0.31	
4	30	9.61	19.44	14.57	7	5.5	14.63	13.13	23.38	-	-	-	-	-	-	22.25	20.75	15.17	3	0.31	
	40	10.63	20.38	15.95	8	6.25	16.5	14.13	25.25	-	-	-	-	-	-	23.25	21.75	16.67	2	0.31	
	5	8.11	18.06	12.24	5.25	4.25	10.25	7.38	17.38	-	-	-	-	-	-	17.5	16	11.45	4.75	0.2	
	7.5	8.90	18.06	12.81	6.25	5	12.88	9.63	19.5	-	-	-	-	-	-	21	19.5	12.95	3.75	0.2	
	10	10.00	18.06	12.81	6.25	5	12.88	9.63	19.5	-	-	-	-	-	-	21	19.5	12.95	3.75	0.2	
	15	10.63	19.44	14.57	7	5.5	14.63	13.13	23.38	-	-	-	-	-	-	22.25	20.75	15.17	3	0.31	
	6	15	10.63	19.44	14.57	7	5.5	14.63	13.13	23.38	-	-	-	-	-	22.25	20.75	15.17	3	0.31	

		Dimensions for pumps with TEFC motor and support rails [inch]																			
Pump size	Pole	Actual impeller size P2 [hp]	Actual impeller size [inch]	TEFC motor						Support rail under pump					Support rail under motor						
				LP	Q	D	E	T	AB	AG	L7	L8	B7	H5	H7	HG3	L4	L6	B4	H6	HG1
050-135	4	25	8.86	20.85	15.38	7	5.5	14.63	13.13	23.38	-	-	-	-	-	-	22.75	21.25	15.17	4	0.31
		30	9.49	20.85	15.38	7	5.5	14.63	13.13	23.38	-	-	-	-	-	-	22.75	21.25	15.17	4	0.31
		40	10.59	21.52	16.49	8	6.25	16.5	14.13	25.25	-	-	-	-	-	-	24.25	22.75	16.67	3	0.31
	6	50	11.30	21.52	16.49	8	6.25	16.5	14.13	25.25	-	-	-	-	-	-	24.25	22.75	16.67	3	0.31
		60	12.01	21.52	17.12	9	7	18.5	18.06	27.63	-	-	-	-	-	-	24.5	23	18.17	2	0.31
		75	13.11-12.95	21.52	17.12	9	7	18.5	18.06	27.75	-	-	-	-	-	-	24.5	23	18.17	2	0.31
050-150	4	10	9.80	20.26	14.41	6.25	5	12.88	9.63	19.5	-	-	-	-	-	-	21.5	20	12.95	4.75	0.2
		15	11.30	20.85	15.38	7	5.5	14.63	13.13	23.38	-	-	-	-	-	-	22.75	21.25	15.17	4	0.31
		20	12.48	20.85	15.38	7	5.5	14.63	13.13	23.38	-	-	-	-	-	-	22.75	21.25	15.17	4	0.31
	6	75	11.73	21.52	17.18	9	7	18.5	18.06	27.75	-	-	-	-	-	-	25.25	23.75	18.17	3.5	0.31
		100	12.99	23.02	19.08	10	8	21.31	19.31	31	-	-	-	-	-	-	27	25.5	21.47	2.5	0.47
		125	14.09	25.03	20.16	11	9	24.24	22.68	36.63	-	-	-	-	-	-	37	35.5	23.16	1.5	0.31
060-095	4	150	14.96	25.03	20.16	11	9	24.24	22.68	36.63	-	-	-	-	-	-	37	35.5	23.16	1.5	0.31
		25	12.28	21.52	16.55	8	6.25	16.5	14.13	25.25	-	-	-	-	-	-	23.75	22.25	16.67	4.5	0.31
		30	13.15	21.52	16.55	8	6.25	16.5	14.13	25.25	-	-	-	-	-	-	23.75	22.25	16.67	4.5	0.31
	6	40	14.49	21.52	17.18	9	7	18.5	18.06	27.63	-	-	-	-	-	-	25.25	23.75	18.17	3.5	0.31
		50	15.59	21.52	17.18	9	7	18.5	18.06	27.75	-	-	-	-	-	-	25.25	23.75	18.17	3.5	0.31
		60	16.14	23.02	19.08	10	8	21.31	19.31	31	-	-	-	-	-	-	27	25.5	21.47	2.5	0.47
060-110	4	15	7.32	20.58	13.98	6.25	5	12.88	9.63	19.5	-	-	-	-	-	-	21.5	20	12.95	4.75	0.2
		20	7.95	20.58	13.98	6.25	5	12.88	9.63	19.5	-	-	-	-	-	-	21.5	20	12.95	4.75	0.2
		25	8.43	21.09	14.87	7	5.5	14.63	13.13	23.38	-	-	-	-	-	-	22.75	21.25	15.17	4	0.31
	6	30	8.90	21.09	14.87	7	5.5	14.63	13.13	23.38	-	-	-	-	-	-	22.75	21.25	15.17	4	0.31
		40	9.53	21.72	15.94	8	6.25	16.5	14.13	25.25	-	-	-	-	-	-	24.25	22.75	16.67	3	0.31
		5	7.56	20.58	13.42	5.25	4.25	10.25	7.38	17.38	-	-	-	-	-	-	17.5	16	11.45	5.75	0.2
060-135	4	7.5	8.35	20.58	13.98	6.25	5	12.88	9.63	19.5	-	-	-	-	-	-	21.5	20	12.95	4.75	0.2
		10	9.21	20.58	13.98	6.25	5	12.88	9.63	19.5	-	-	-	-	-	-	21.5	20	12.95	4.75	0.2
		15	9.53	21.09	14.87	7	5.5	14.63	13.13	23.38	-	-	-	-	-	-	22.75	21.25	15.17	4	0.31
	6	30	8.78	21.6	15.38	7	5.5	14.63	13.13	23.38	-	-	-	-	-	-	22.75	21.25	15.17	4	0.31
		40	9.57	22.27	16.49	8	6.25	16.5	14.13	25.25	-	-	-	-	-	-	24.25	22.75	16.67	3	0.31
		50	10.20	22.27	16.49	8	6.25	16.5	14.13	25.25	-	-	-	-	-	-	24.25	22.75	16.67	3	0.31
060-150	4	60	10.75	22.27	17.12	9	7	18.5	18.06	27.63	-	-	-	-	-	-	24.5	23	18.17	2	0.31
		7.5	8.39	21.01	14.41	6.25	5	12.88	9.63	19.5	-	-	-	-	-	-	21.5	20	12.95	4.75	0.2
		10	9.17	21.01	14.41	6.25	5	12.88	9.63	19.5	-	-	-	-	-	-	21.5	20	12.95	4.75	0.2
	6	15	10.20	21.6	15.38	7	5.5	14.63	13.13	23.38	-	-	-	-	-	-	22.75	21.25	15.17	4	0.31
		20	10.75	21.6	15.38	7	5.5	14.63	13.13	23.38	-	-	-	-	-	-	22.75	21.25	15.17	4	0.31
		40	9.25	22.27	16.49	8	6.25	16.5	14.13	25.25	-	-	-	-	-	-	24.25	22.75	16.67	3	0.31
060-175	4	50	9.96	22.27	16.49	8	6.25	16.5	14.13	25.25	-	-	-	-	-	-	24.25	22.75	16.67	3	0.31
		60	10.35	22.27	17.12	9	7	18.5	18.06	27.63	-	-	-	-	-	-	24.5	23	18.17	2	0.31
		75	11.22	22.27	17.12	9	7	18.5	18.06	27.75	-	-	-	-	-	-	24.5	23	18.17	2	0.31
	6	100	12.24	23.77	18.61	10	8	21.31	19.31	31	-	-	-	-	-	-	27.5	26	19.94	1	0.5
		125	12.91-12.76	25.78	18.23	11	9	24.24	22.68	36.63	11.5	5	21.65	1	12	0.5	29.5	28	21.94	1	0.5
		10	8.70	21.01	14.41	6.25	5	12.88	9.63	19.5	-	-	-	-	-	-	21.5	20	12.95	4.75	0.2
060-200	4	15	9.80	21.6	15.38	7	5.5	14.63	13.13	23.38	-	-	-	-	-	-	22.75	21.25	15.17	4	0.31
		20	10.75	21.6	15.38	7	5.5	14.63	13.13	23.38	-	-	-	-	-	-	22.75	21.25	15.17	4	0.31
		25	11.54	22.27	16.49	8	6.25	16.5	14.13	25.25	-	-	-	-	-	-	24.25	22.75	16.67	3	0.31
	6	30	12.48-12.32	22.27	16.49	8	6.25	16.5	14.13	25.25	-	-	-	-	-	-	24.25	22.75	16.67	3	0.31

Dimensions for pumps with TEFC motor and support rails [inch]																					
Pump size	Pole	P2 [hp]	Actual impeller size [inch]	TEFC motor						Support rail under pump						Support rail under motor					
				LP	Q	D	E	T	AB	AG	L7	L8	B7	H5	H7	HG3	L4	L6	B4	H6	HG1
060-150	4	125	11.97	25.62	20	11	9	24.24	22.68	36.63	-	-	-	-	-	-	37	35.5	23.16	1.5	0.31
		150	12.83	25.62	20	11	9	24.24	22.68	36.63	-	-	-	-	-	-	37	35.5	23.16	1.5	0.31
		200	14.80	25.62	20	11	9	24.24	22.68	45	-	-	-	-	-	-	37	35.5	23.16	1.5	0.31
	6	40	12.44	24.64	19.55	9	7	18.5	18.06	27.63	-	-	-	-	-	-	25.25	23.75	18.17	3.5	0.31
		50	13.70	24.64	19.55	9	7	18.5	18.06	27.75	-	-	-	-	-	-	25.25	23.75	18.17	3.5	0.31
		60	14.88	24.64	19.95	10	8	21.31	19.31	31	-	-	-	-	-	-	27	25.5	21.47	2.5	0.47
		75	16.06	24.64	19.95	10	8	21.31	19.31	31	-	-	-	-	-	-	27	25.5	21.47	2.5	0.47
080-135	4	60	9.84	22.27	17.12	9	7	18.5	18.06	27.63	-	-	-	-	-	-	24.5	23	18.17	4.75	0.31
		75	10.31	22.27	17.12	9	7	18.5	18.06	27.75	-	-	-	-	-	-	24.5	23	18.17	4.75	0.31
	6	100	11.26	23.77	19.24	10	8	21.31	19.31	31	-	-	-	-	-	-	26.25	24.75	20.17	3.75	0.31
		125	11.89	25.78	20	11	9	24.24	22.68	36.63	-	-	-	-	-	-	31.75	30.25	23.47	2.75	0.47
		150	12.60	25.78	20	11	9	24.24	22.68	36.63	-	-	-	-	-	-	31.75	30.25	23.47	2.75	0.47
		15	9.29	21.6	15.38	7	5.5	14.63	13.13	23.38	-	-	-	-	-	-	22.75	21.25	15.17	6.75	0.31
		20	10.16	21.6	15.38	7	5.5	14.63	13.13	23.38	-	-	-	-	-	-	22.75	21.25	15.17	6.75	0.31
6	25	10.79	22.27	16.49	8	6.25	16.5	14.13	25.25	-	-	-	-	-	-	24.25	22.75	16.67	5.75	0.31	
	30	11.26	22.27	16.49	8	6.25	16.5	14.13	25.25	-	-	-	-	-	-	24.25	22.75	16.67	5.75	0.31	
	40	12.28	22.27	17.12	9	7	18.5	18.06	27.63	-	-	-	-	-	-	24.5	23	18.17	4.75	0.31	
	50	13.15	22.27	17.12	9	7	18.5	18.06	27.75	-	-	-	-	-	-	24.5	23	18.17	4.75	0.31	
	080-150	4	125	12.20	26.62	19.84	11	9	24.24	22.68	36.63	-	-	-	-	-	-	37.75	36.25	23.47	4.75
150			12.99	26.62	19.84	11	9	24.24	22.68	36.63	-	-	-	-	-	-	37.75	36.25	23.47	4.75	0.47
6		200	14.25	26.62	19.84	11	9	24.24	22.68	45	-	-	-	-	-	-	37.75	36.25	23.47	4.75	0.47
		40	12.60	25.64	19.33	9	7	18.5	18.06	27.63	-	-	-	-	-	-	25.75	24.25	18.49	6.75	0.47
		50	13.46	25.64	19.33	9	7	18.5	18.06	27.75	-	-	-	-	-	-	25.75	24.25	18.49	6.75	0.47
		60	14.25	25.64	19.95	10	8	21.31	19.31	31	-	-	-	-	-	-	27.5	26	21.47	5.75	0.47
		75	15.59	25.64	19.95	10	8	21.31	19.31	31	-	-	-	-	-	-	27.5	26	21.47	5.75	0.47
100-150	4	150	12.48	26.62	20.19	11	9	24.24	22.68	36.63	-	-	-	-	-	-	37.5	36	23.47	4.75	0.47
		200	13.66	26.22	20.19	11	9	24.24	22.68	36.63	-	-	-	-	-	-	37.5	36	23.47	6.75	0.47
	6	50	12.95	26.22	19.84	11	7	24.24	22.68	45	-	-	-	-	-	-	25.5	24	18.17	6.75	0.47
		60	13.82	25.24	20.31	9	8	18.5	18.06	27.75	-	-	-	-	-	-	27.5	26	21.47	8.75	0.31
		75	14.92	25.24	20.31	10	8	21.31	19.31	31	-	-	-	-	-	-	27.5	26	21.47	7.75	0.47
100	16.34	25.24	20.19	10	9	21.31	19.31	31	-	-	-	-	-	-	37.5	36	23.47	7.75	0.47		

27) Low pressure (Class 125) pump.

28) High pressure (Class 300) pump.

## Dimensions in mm.

		Dimensions for pumps with TEFC motor and support rails [mm]																			
Pump size	Pole	P2 [hp]	Actual impeller size [mm]	TEFC motor						Support rail under pump					Support rail under motor						
				LP	Q	D	E	T	AB	AG	L7	L8	B7	H5	H7	HG3	L4	L6	B4	H6	HG1
012-070	2	3	109	372	242	114	95	221	149	394	197	80	290	44	178	5	349	311	265	64	5
		7.5	125	372	242	114	95	221	149	394	197	80	290	44	178	5	349	311	265	64	5
		7.5	145	372	265	133	108	260	187	441	197	80	290	44	178	5	423	385	291	44	5
		7.5	149	372	265	133	108	260	187	441	197	80	290	44	178	5	423	385	291	44	5
		15	155	372	265	133	108	260	187	441	197	80	290	44	178	5	423	385	291	44	5
	4	15	163	372	260	159	127	327	245	495	197	80	290	44	178	5	514	476	304	19	10
		15	177	372	260	159	127	327	245	495	197	80	290	44	178	5	514	476	304	19	10
		1	127	339	198	89	70	175	133	286	197	80	265	25	159	13	338	299	215	70	5
		1	141	339	198	89	70	175	133	286	197	80	265	25	159	13	338	299	215	70	5
		1	155	339	198	89	70	175	133	286	197	80	265	25	159	13	338	299	215	70	5
015-070	2	1.5	177	339	198	89	70	175	133	286	197	80	265	25	159	13	338	299	215	70	5
		5	114	372	242	114	95	221	149	394	197	80	290	44	178	5	349	311	265	64	5
		7.5	128	372	265	133	108	260	187	441	197	80	290	44	178	5	423	385	291	44	5
		10	142	372	265	133	108	260	187	441	197	80	290	44	178	5	423	385	291	44	5
		15	160	372	260	159	127	327	245	495	197	80	290	44	178	5	514	476	304	19	10
	4	20	176	372	260	159	127	327	245	495	197	80	290	44	178	5	514	476	304	19	10
		1	118	339	198	89	70	175	133	286	197	80	265	25	159	13	338	299	215	70	5
		1	130	339	198	89	70	175	133	286	197	80	265	25	159	13	338	299	215	70	5
		1.5	150	339	198	89	70	175	133	286	197	80	265	25	159	13	338	299	215	70	5
		2	166	339	198	89	70	175	133	286	197	80	265	25	159	13	338	299	215	70	5
015-090	2	3	176	372	242	114	95	221	149	394	197	80	290	44	178	5	349	311	265	64	5
		15	180	435	308	159	127	327	245	495	222	92	325	25	203	13	508	470	329	44	5
		20	198	435	308	159	127	327	245	495	222	92	325	25	203	13	508	470	329	44	5
		25	210	392	258	178	140	372	334	552	222	92	325	25	203	13	565	527	354	25	13
		30	224	392	258	178	140	372	334	552	222	92	325	25	203	13	565	527	354	25	13
	4	40	250	415	289	203	159	419	359	641	229	95	350	51	229	5	597	559	392	25	13
		1.5	170	361	231	89	70	175	133	286	-	-	-	-	-	-	363	325	215	89	5
		2	184	361	231	89	70	175	133	286	-	-	-	-	-	-	363	325	215	89	5
		3	206	394	275	114	95	221	149	394	-	-	-	-	-	-	372	334	265	64	5
		5	250	394	275	114	95	221	149	394	-	-	-	-	-	-	372	334	265	64	5
015-095	2	15	164	435	308	159	127	327	245	495	222	92	325	25	203	13	508	470	329	44	5
		20	178	435	308	159	127	327	245	495	222	92	325	25	203	13	508	470	329	44	5
		25	190	392	258	178	140	372	334	552	222	92	325	25	203	13	565	527	354	25	13
		30	200	392	258	178	140	372	334	552	222	92	325	25	203	13	565	527	354	25	13
		40	224	415	289	203	159	419	359	641	229	95	350	51	229	5	597	559	392	25	13
	4	50	246	415	289	203	159	419	359	641	229	95	350	51	229	5	597	559	392	25	13
		2	166	361	231	89	70	175	133	286	-	-	-	-	-	-	363	325	215	89	5
		3	186	394	275	114	95	221	149	394	-	-	-	-	-	-	372	334	265	64	5
		5	224	394	275	114	95	221	149	394	-	-	-	-	-	-	372	334	265	64	5
		7.5	250	394	297	133	108	260	187	441	-	-	-	-	-	-	423	385	291	44	5
020-095	2	15	146	446	318	159	127	327	245	495	222	92	325	25	203	13	508	470	329	44	5
		20	160	446	318	159	127	327	245	495	222	92	325	25	203	13	508	470	329	44	5
		25	172	403	269	178	140	372	334	552	222	92	325	25	203	13	565	527	354	25	13
		30	182	403	269	178	140	372	334	552	222	92	325	25	203	13	565	527	354	25	13
	4	40	204	426	300	203	159	419	359	641	229	95	350	51	229	5	597	559	392	25	13
		50	218	426	300	203	159	419	359	641	229	95	350	51	229	5	597	559	392	25	13
		60	226 <sup>27)</sup>	426	312	229	178	470	459	705	229	95	350	76	254	5	622	584	431	25	13
		60	240 <sup>28)</sup>	426	312	229	178	470	459	705	229	95	350	76	254	5	622	584	431	25	13



Dimensions for pumps with TEFC motor and support rails [mm]																					
Pump size	Pole	P2 [hp]	Actual impeller size [mm]	TEFC motor						Support rail under pump						Support rail under motor					
				LP	Q	D	E	T	AB	AG	L7	L8	B7	H5	H7	HG3	L4	L6	B4	H6	HG1
020-110	4	2	148	361	231	89	70	175	133	286	-	-	-	-	-	-	363	325	215	89	5
		3	168	394	275	114	95	221	149	394	-	-	-	-	-	-	372	334	265	64	5
		5	206	394	275	114	95	221	149	394	-	-	-	-	-	-	372	334	265	64	5
		7.5	240	394	297	133	108	260	187	441	-	-	-	-	-	-	423	385	291	44	5
020-135	4	5	206	394	275	114	95	221	149	394	-	-	-	-	-	-	372	334	265	64	5
		7.5	228	394	297	133	108	260	187	441	-	-	-	-	-	-	423	385	291	44	5
		10	252	394	297	133	108	260	187	441	-	-	-	-	-	-	423	385	291	44	5
		15	262	394	292	159	127	327	245	495	-	-	-	-	-	-	514	476	304	19	10
025-070	2	7.5	116	394	252	133	108	260	187	441	222	92	287	19	178	10	423	385	291	44	5
		10	126	394	252	133	108	260	187	441	222	92	287	19	178	10	423	385	291	44	5
		15	144	435	248	159	127	327	245	495	222	92	287	19	178	10	514	476	304	19	10
		20	160	435	248	159	127	327	245	495	222	92	287	19	178	10	514	476	304	19	10
025-095	4	25	168	392	255	178	140	372	334	552	229	95	312	44	203	5	565	527	354	25	13
		30	172	392	255	178	140	372	334	552	229	95	312	44	203	5	565	527	354	25	13
		1	118	361	231	89	70	175	133	286	-	-	-	-	-	-	338	299	215	70	5
		1.5	134	361	231	89	70	175	133	286	-	-	-	-	-	-	338	299	215	70	5
025-110	4	2	148	361	231	89	70	175	133	286	-	-	-	-	-	-	338	299	215	70	5
		3	168	394	230	114	95	221	149	394	222	92	287	19	178	10	372	334	265	64	5
		5	172	394	230	114	95	221	149	394	222	92	287	19	178	10	372	334	265	64	5
		25	152	403	303	178	140	372	334	552	-	-	-	-	-	-	565	527	354	25	13
		30	160	403	303	178	140	372	334	552	-	-	-	-	-	-	565	527	354	25	13
		40	182	426	281	203	159	419	359	641	267	114	380	25	229	13	597	559	392	25	13
		50	198	426	281	203	159	419	359	641	267	114	380	25	229	13	597	559	392	25	13
		60	214	426	293	229	178	470	459	705	267	114	405	51	254	5	622	584	431	25	13
		75	238 <sup>27)</sup>	426	293	229	178	470	459	705	267	114	405	51	254	5	622	584	431	25	13
		75	242 <sup>28)</sup>	426	293	229	178	470	459	705	267	114	405	51	254	5	622	584	431	25	13
025-095	4	3	152	394	264	114	95	221	149	394	-	-	-	-	-	-	372	334	265	89	5
		5	182	394	264	114	95	221	149	394	-	-	-	-	-	-	372	334	265	89	5
		7.5	214	394	287	133	108	260	187	441	-	-	-	-	-	-	423	385	291	70	5
		10	242	394	287	133	108	260	187	441	-	-	-	-	-	-	423	385	291	70	5
		1	154	361	220	89	70	175	133	286	-	-	-	-	-	-	368	330	215	114	5
025-110	6	1.5	182	394	264	114	95	221	149	394	-	-	-	-	-	-	372	334	265	89	5
		2	208	394	264	114	95	221	149	394	-	-	-	-	-	-	372	334	265	89	5
		3	242	394	287	133	108	260	187	441	-	-	-	-	-	-	423	385	291	70	5
		7.5	218	446	311	133	108	260	187	441	-	-	-	-	-	-	423	385	291	70	5
025-110	4	10	240	446	311	133	108	260	187	441	-	-	-	-	-	-	423	385	291	70	5
		15	280	446	325	159	127	327	245	495	-	-	-	-	-	-	508	470	329	44	5
		2	214	446	289	114	95	221	149	394	-	-	-	-	-	-	372	334	265	89	5
		3	244	446	311	133	108	260	187	441	-	-	-	-	-	-	423	385	291	70	5
		5	280	446	311	133	108	260	187	441	-	-	-	-	-	-	423	385	291	70	5

Dimensions for pumps with TEFC motor and support rails [mm]																					
Pump size	Pole	P2 [hp]	Actual impeller size [mm]	TEFC motor						Support rail under pump						Support rail under motor					
				LP	Q	D	E	T	AB	AG	L7	L8	B7	H5	H7	HG3	L4	L6	B4	H6	HG1
030-070	2	15	128	435	248	159	127	327	245	495	222	92	287	19	178	10	514	476	304	19	10
		20	142	435	248	159	127	327	245	495	222	92	287	19	178	10	514	476	304	19	10
		25	148	392	255	178	140	372	334	552	229	95	312	44	203	5	565	527	354	25	13
		30	160	392	255	178	140	372	334	552	229	95	312	44	203	5	565	527	354	25	13
		40	174	415	289	203	159	419	359	641	229	95	312	70	229	5	597	559	392	25	13
	4	1.5	120	361	231	89	70	175	133	286	-	-	-	-	-	-	338	299	215	70	5
		2	132	361	231	89	70	175	133	286	-	-	-	-	-	-	338	299	215	70	5
		3	148	394	230	114	95	221	149	394	222	92	287	19	178	10	372	334	265	64	5
		5	174	394	230	114	95	221	149	394	222	92	287	19	178	10	372	334	265	64	5
		40	155	471	300	203	159	419	359	641	267	114	415	25	229	13	597	559	392	25	13
030-095	2	50	165	471	300	203	159	419	359	641	267	114	415	25	229	13	597	559	392	25	13
		60	175	471	313	229	178	470	459	705	267	114	440	51	254	5	622	584	431	25	13
		75	187	471	313	229	178	470	459	705	267	114	440	51	254	5	622	584	431	25	13
	4	100	205	471	339	254	203	541	490	787	254	108	440	76	279	5	699	660	506	25	13
		125	225	484	343	279	229	616	576	930	254	108	415	102	305	5	749	711	557	25	13
		5	155	439	282	114	95	221	149	394	-	-	-	-	-	-	372	334	265	89	5
6	7.5	171	439	304	133	108	260	187	441	-	-	-	-	-	-	423	385	291	70	5	
	10	191	439	304	133	108	260	187	441	-	-	-	-	-	-	423	385	291	70	5	
	15	225	439	319	159	127	327	245	495	-	-	-	-	-	-	508	470	329	44	5	
	1.5	153	439	282	114	95	221	149	394	-	-	-	-	-	-	372	334	265	89	5	
	2	167	439	282	114	95	221	149	394	-	-	-	-	-	-	372	334	265	89	5	
030-110	4	3	191	439	304	133	108	260	187	441	-	-	-	-	-	-	423	385	291	70	5
		5	225	439	304	133	108	260	187	441	-	-	-	-	-	-	423	385	291	70	5
		10	216-208	446	311	133	108	260	187	441	-	-	-	-	-	-	423	385	291	70	5
		15	248-240	446	325	159	127	327	245	495	-	-	-	-	-	-	508	470	329	44	5
		20	278-270	446	325	159	127	327	245	495	-	-	-	-	-	-	508	470	329	44	5
	6	3	218-210	446	311	133	108	260	187	441	-	-	-	-	-	-	423	385	291	70	5
		5	266-258	446	311	133	108	260	187	441	-	-	-	-	-	-	423	385	291	70	5
		7.5	278-270	446	325	159	127	327	245	495	-	-	-	-	-	-	508	470	329	44	5
		15	228	446	325	159	127	327	245	495	-	-	-	-	-	-	533	495	329	95	5
		20	252	446	325	159	127	327	245	495	-	-	-	-	-	-	533	495	329	95	5
030-135	4	25	270	481	370	178	140	372	334	594	-	-	-	-	-	-	565	527	385	76	8
		30	286	481	370	178	140	372	334	594	-	-	-	-	-	-	565	527	385	76	8
		40	328	505	405	203	159	419	359	641	-	-	-	-	-	-	591	552	423	51	8
		5	228	446	311	133	108	260	187	441	-	-	-	-	-	-	445	406	291	121	5
	6	7.5	268	446	325	159	127	327	245	495	-	-	-	-	-	-	533	495	329	95	5
		10	298	446	325	159	127	327	245	495	-	-	-	-	-	-	533	495	329	95	5
		15	328	481	370	178	140	372	334	594	-	-	-	-	-	-	565	527	385	76	8
		20	138-122	461	308	159	127	327	245	495	222	92	355	25	203	13	508	470	329	44	5
040-070	2	25	140	418	258	178	140	372	334	552	222	92	355	25	203	13	565	527	354	25	13
		30	146	418	258	178	140	372	334	552	222	92	355	25	203	13	565	527	354	25	13
		40	160	440	289	203	159	419	359	641	229	95	380	51	229	5	597	559	392	25	13
		50	172	440	289	203	159	419	359	641	229	95	380	51	229	5	597	559	392	25	13
	4	2	130-110	387	231	89	70	175	133	286	-	-	-	-	-	-	363	325	215	89	5
		3	138	420	275	114	95	221	149	394	-	-	-	-	-	-	372	334	265	64	5
		5	160	420	275	114	95	221	149	394	-	-	-	-	-	-	372	334	265	64	5
		7.5	174	420	297	133	108	260	187	441	-	-	-	-	-	-	423	385	291	44	5

Dimensions for pumps with TEFC motor and support rails [mm]																				
Pump size	Pole	P2 [hp]	Actual impeller size [mm]	TEFC motor						Support rail under pump						Support rail under motor				
				LP	Q	D	E	T	AB	AG	L7	L8	B7	H5	H7	HG3	L4	L6	B4	H6
6	0.75	130-122	387	231	89	70	175	133	286	-	-	-	-	-	-	363	325	215	89	5
	1	140	387	231	89	70	175	133	286	-	-	-	-	-	-	363	325	215	89	5
	1.5	156	420	275	114	95	221	149	394	-	-	-	-	-	-	372	334	265	64	5
	2	174	420	275	114	95	221	149	394	-	-	-	-	-	-	372	334	265	64	5
2	60	164	484	313	229	178	470	459	705	267	114	415	25	254	13	622	584	431	25	13
	75	176	484	313	229	178	470	459	705	267	114	415	25	254	13	622	584	431	25	13
	100	196	484	332	254	203	541	490	787	267	114	440	51	279	5	699	660	506	25	13
	125	212	497	343	279	229	616	576	930	254	108	440	76	305	5	749	711	557	25	13
4	7.5	162	452	304	133	108	260	187	441	-	-	-	-	-	-	423	385	291	95	5
	10	180	452	304	133	108	260	187	441	-	-	-	-	-	-	423	385	291	95	5
	15	212	452	319	159	127	327	245	495	-	-	-	-	-	-	521	483	329	70	5
	20	238	452	319	159	127	327	245	495	-	-	-	-	-	-	521	483	329	70	5
6	2	160	452	282	114	95	221	149	394	-	-	-	-	-	-	387	349	265	114	5
	3	180	452	304	133	108	260	187	441	-	-	-	-	-	-	423	385	291	95	5
	5	228	452	304	133	108	260	187	441	-	-	-	-	-	-	423	385	291	95	5
	7.5	238	452	319	159	127	327	245	495	-	-	-	-	-	-	521	483	329	70	5
4	15	206	459	325	159	127	327	245	495	-	-	-	-	-	-	521	483	329	70	5
	20	222	459	325	159	127	327	245	495	-	-	-	-	-	-	521	483	329	70	5
	25	240	494	370	178	140	372	334	594	-	-	-	-	-	-	552	514	385	51	8
	30	256	494	370	178	140	372	334	594	-	-	-	-	-	-	552	514	385	51	8
6	3	182	459	311	133	108	260	187	441	-	-	-	-	-	-	423	385	291	95	5
	5	212	459	311	133	108	260	187	441	-	-	-	-	-	-	423	385	291	95	5
	7.5	238	459	325	159	127	327	245	495	-	-	-	-	-	-	521	483	329	70	5
	10	256	459	325	159	127	327	245	495	-	-	-	-	-	-	521	483	329	70	5
4	20	236	459	327	159	127	327	245	495	-	-	-	-	-	-	533	495	329	95	5
	25	260	494	372	178	140	372	334	594	-	-	-	-	-	-	565	527	385	76	8
	30	278	494	372	178	140	372	334	594	-	-	-	-	-	-	565	527	385	76	8
	40	300	518	407	203	159	419	359	641	-	-	-	-	-	-	591	552	423	51	8
6	50	326	518	407	203	159	419	359	641	-	-	-	-	-	-	591	552	423	51	8
	5	222	459	313	133	108	260	187	441	-	-	-	-	-	-	445	406	291	121	5
	7.5	258	459	327	159	127	327	245	495	-	-	-	-	-	-	533	495	329	95	5
	10	284	459	327	159	127	327	245	495	-	-	-	-	-	-	533	495	329	95	5
4	15	320	494	372	178	140	372	334	594	-	-	-	-	-	-	565	527	385	76	8
	50	310	547	419	203	159	419	359	641	-	-	-	-	-	-	616	578	423	76	8
	60	328	547	435	229	178	470	459	702	-	-	-	-	-	-	622	584	462	51	8
	75	352	547	435	229	178	470	459	705	-	-	-	-	-	-	622	584	462	51	8
6	100	386	585	473	254	203	541	490	787	-	-	-	-	-	-	699	660	506	25	13
	125	408	636	463	279	229	616	576	930	292	127	500	25	305	13	749	711	557	25	13
	150	426	636	463	279	229	616	576	930	292	127	500	25	305	13	749	711	557	25	13
	15	304	530	391	178	140	372	334	594	-	-	-	-	-	-	578	540	385	102	8
6	20	340	530	391	178	140	372	334	594	-	-	-	-	-	-	578	540	385	102	8
	25	368	547	419	203	159	419	359	641	-	-	-	-	-	-	616	578	423	76	8
	30	388	547	419	203	159	419	359	641	-	-	-	-	-	-	616	578	423	76	8
	40	424	547	435	229	178	470	459	702	-	-	-	-	-	-	622	584	462	51	8

Dimensions for pumps with TEFC motor and support rails [mm]																					
Pump size	Pole	P2 [hp]	Actual impeller size [mm]	TEFC motor						Support rail under pump						Support rail under motor					
				LP	Q	D	E	T	AB	AG	L7	L8	B7	H5	H7	HG3	L4	L6	B4	H6	HG1
050-070	2	25	142-114	418	291	178	140	372	334	552	-	-	-	-	-	-	565	527	354	25	13
		30	152-124	418	291	178	140	372	334	552	-	-	-	-	-	-	565	527	354	25	13
		40	154	440	270	203	159	419	359	641	267	114	380	25	229	13	597	559	392	25	13
		50	164	440	270	203	159	419	359	641	267	114	380	25	229	0	597	559	392	25	13
		60	172	440	283	229	178	470	459	705	267	114	405	51	254	5	622	584	431	25	13
		75	176	440	283	229	178	616	459	705	267	114	405	51	254	5	622	584	431	25	13
	4	3	138-110	420	262	114	95	221	149	394	-	-	-	-	-	-	372	334	265	89	5
		5	154	420	262	114	95	616	149	394	-	-	-	-	-	-	372	334	265	89	5
		7.5	168	420	284	133	108	260	187	441	-	-	-	-	-	-	423	385	291	70	5
		10	176	420	284	133	108	260	187	441	-	-	-	-	-	-	423	385	291	70	5
		0.75	134-106	387	218	89	70	175	133	286	-	-	-	-	-	-	368	330	215	114	5
		1	150-106	387	218	89	70	175	133	286	-	-	-	-	-	-	368	330	215	114	5
6	1.5	154	420	262	114	95	221	149	394	-	-	-	-	-	-	372	334	265	89	5	
	2	168	420	262	114	95	616	149	394	-	-	-	-	-	-	372	334	265	89	5	
	3	176	420	284	133	108	260	187	441	-	-	-	-	-	-	423	385	291	70	5	
	10	174-154	504	356	133	108	260	187	441	-	-	-	-	-	-	445	406	291	121	5	
	15	188	504	370	159	127	327	245	495	-	-	-	-	-	-	533	495	329	95	5	
	20	208	504	370	159	127	327	245	495	-	-	-	-	-	-	533	495	329	95	5	
050-095	4	25	222	517	393	178	140	372	334	594	-	-	-	-	-	565	527	385	76	8	
		30	232	517	393	178	140	372	334	594	-	-	-	-	-	565	527	385	76	8	
		3	174-154	504	356	133	108	260	187	441	-	-	-	-	-	445	406	291	76	5	
	6	5	196	504	356	133	108	260	187	441	-	-	-	-	-	445	406	291	121	5	
		7.5	222	504	370	159	127	327	245	495	-	-	-	-	-	533	495	329	95	5	
		10	232	504	370	159	127	327	245	495	-	-	-	-	-	533	495	329	95	5	
050-110	4	20	212	459	325	159	127	327	245	495	-	-	-	-	-	533	495	329	95	5	
		25	230	494	370	178	140	372	334	594	-	-	-	-	-	565	527	385	76	8	
		30	244	494	370	178	140	372	334	594	-	-	-	-	-	565	527	385	76	8	
	6	40	270	518	405	203	159	419	359	641	-	-	-	-	-	591	552	423	51	8	
		5	206	459	311	133	108	260	187	441	-	-	-	-	-	445	406	291	121	5	
		7.5	226	459	325	159	127	327	245	495	-	-	-	-	-	533	495	329	95	5	
050-135	4	10	254	459	325	159	127	327	245	495	-	-	-	-	-	533	495	329	95	5	
		15	270	494	370	178	140	372	334	594	-	-	-	-	-	565	527	385	76	8	
		25	225	530	391	178	140	372	334	594	-	-	-	-	-	578	540	385	102	8	
	6	30	241	530	391	178	140	372	334	594	-	-	-	-	-	578	540	385	102	8	
		40	269	547	419	203	159	419	359	641	-	-	-	-	-	616	578	423	76	8	
		50	287	547	419	203	159	419	359	641	-	-	-	-	-	616	578	423	76	8	
050-150	4	60	305	547	435	229	178	470	459	702	-	-	-	-	-	622	584	462	51	8	
		75	333-329	547	435	229	178	470	459	705	-	-	-	-	-	622	584	462	51	8	
		10	249	515	366	159	127	327	245	495	-	-	-	-	-	546	508	329	121	5	
	6	15	287	530	391	178	140	372	334	594	-	-	-	-	-	578	540	385	102	8	
		20	317	530	391	178	140	372	334	594	-	-	-	-	-	578	540	385	102	8	
		75	298	547	436	229	178	470	459	705	-	-	-	-	-	641	603	462	89	8	
4	100	330	585	485	254	203	541	490	787	-	-	-	-	-	686	648	545	64	12		
	125	358	636	512	279	229	616	576	930	-	-	-	-	-	940	902	588	38	8		
	150	380	636	512	279	229	616	576	930	-	-	-	-	-	940	902	588	38	8		

Dimensions for pumps with TEFC motor and support rails [mm]

Pump size	Pole	P2 [hp]	Actual impeller size [mm]	TEFC motor						Support rail under pump						Support rail under motor					
				LP	Q	D	E	T	AB	AG	L7	L8	B7	H5	H7	HG3	L4	L6	B4	H6	HG1
060-095	6	25	312	547	420	203	159	419	359	641	-	-	-	-	-	-	603	565	423	114	8
		30	334	547	420	203	159	419	359	641	-	-	-	-	-	-	603	565	423	114	8
		40	368	547	436	229	178	470	459	702	-	-	-	-	-	-	641	603	462	89	8
		50	396	547	436	229	178	470	459	705	-	-	-	-	-	-	641	603	462	89	8
		60	410	585	485	254	203	541	490	787	-	-	-	-	-	-	686	648	545	64	12
060-095	4	15	186	523	355	159	127	327	245	495	-	-	-	-	-	-	546	508	329	121	5
		20	202	523	355	159	127	327	245	495	-	-	-	-	-	-	546	508	329	121	5
		25	214	536	378	178	140	372	334	594	-	-	-	-	-	-	578	540	385	102	8
		30	226	536	378	178	140	372	334	594	-	-	-	-	-	-	578	540	385	102	8
		40	242	552	405	203	159	419	359	641	-	-	-	-	-	-	616	578	423	76	8
060-095	6	5	192	523	341	133	108	260	187	441	-	-	-	-	-	-	445	406	291	146	5
		7.5	212	523	355	159	127	327	245	495	-	-	-	-	-	-	546	508	329	121	5
		10	234	523	355	159	127	327	245	495	-	-	-	-	-	-	546	508	329	121	5
		15	242	536	378	178	140	372	334	594	-	-	-	-	-	-	578	540	385	102	8
		30	223	549	391	178	140	372	334	594	-	-	-	-	-	-	578	540	385	102	8
060-110	4	40	243	566	419	203	159	419	359	641	-	-	-	-	-	-	616	578	423	76	8
		50	259	566	419	203	159	419	359	641	-	-	-	-	-	-	616	578	423	76	8
		60	273	566	435	229	178	470	459	702	-	-	-	-	-	-	622	584	462	51	8
		7.5	213	534	366	159	127	327	245	495	-	-	-	-	-	-	546	508	329	121	5
		10	233	534	366	159	127	327	245	495	-	-	-	-	-	-	546	508	329	121	5
060-110	6	15	259	549	391	178	140	372	334	594	-	-	-	-	-	-	578	540	385	102	8
		20	273	549	391	178	140	372	334	594	-	-	-	-	-	-	578	540	385	102	8
		40	235	566	419	203	159	419	359	641	-	-	-	-	-	-	616	578	423	76	8
		50	253	566	419	203	159	419	359	641	-	-	-	-	-	-	616	578	423	76	8
		60	263	566	435	229	178	470	459	702	-	-	-	-	-	-	622	584	462	51	8
060-135	4	75	285	566	435	229	178	470	459	705	-	-	-	-	-	-	622	584	462	51	8
		100	311	604	473	254	203	541	490	787	-	-	-	-	-	-	699	660	506	25	13
		125	328-324	655	463	279	229	616	576	930	292	127	550	25	305	13	749	711	557	25	13
		10	221	534	366	159	127	327	245	495	-	-	-	-	-	-	546	508	329	121	5
		15	249	549	391	178	140	372	334	594	-	-	-	-	-	-	578	540	385	102	8
060-135	6	20	273	549	391	178	140	372	334	594	-	-	-	-	-	-	578	540	385	102	8
		25	293	566	419	203	159	419	359	641	-	-	-	-	-	-	616	578	423	76	8
		30	317-313	566	419	203	159	419	359	641	-	-	-	-	-	-	616	578	423	76	8
		125	304	651	508	279	229	616	576	930	-	-	-	-	-	-	940	902	588	38	8
		150	326	651	508	279	229	616	576	930	-	-	-	-	-	-	940	902	588	38	8
060-150	4	200	376	651	508	279	229	616	576	1143	-	-	-	-	-	-	940	902	588	38	8
		40	316	626	497	229	178	470	459	702	-	-	-	-	-	-	641	603	462	89	8
		50	348	626	497	229	178	470	459	705	-	-	-	-	-	-	641	603	462	89	8
		60	378	626	507	254	203	541	490	787	-	-	-	-	-	-	686	648	545	64	12
		75	408	626	507	254	203	541	490	787	-	-	-	-	-	-	686	648	545	64	12
060-150	6	100	430	651	508	279	229	616	576	930	-	-	-	-	-	-	940	902	588	38	8
		60	250	566	435	229	178	470	459	702	-	-	-	-	-	-	622	584	462	121	8
		75	262	566	435	229	178	470	459	705	-	-	-	-	-	-	622	584	462	121	8
		100	286	604	489	254	203	541	490	787	-	-	-	-	-	-	667	629	512	95	8
		125	302	655	508	279	229	616	576	930	-	-	-	-	-	-	806	768	596	70	12
080-135	4	150	320	655	508	279	229	616	576	930	-	-	-	-	-	-	806	768	596	70	12

Dimensional drawings and technical data

Dimensions for pumps with TEFC motor and support rails [mm]																				
Pump size	Pole	P2 [hp]	Actual impeller size [mm]	TEFC motor						Support rail under pump						Support rail under motor				
				LP	Q	D	E	T	AB	AG	L7	L8	B7	H5	H7	HG3	L4	L6	B4	H6
6	15	236	549	391	178	140	372	334	594	-	-	-	-	-	-	578	540	385	171	8
	20	258	549	391	178	140	372	334	594	-	-	-	-	-	-	578	540	385	171	8
	25	274	566	419	203	159	419	359	641	-	-	-	-	-	-	616	578	423	146	8
	30	286	566	419	203	159	419	359	641	-	-	-	-	-	-	616	578	423	146	8
	40	312	566	435	229	178	470	459	702	-	-	-	-	-	-	622	584	462	121	8
	50	334	566	435	229	178	470	459	705	-	-	-	-	-	-	622	584	462	121	8
4	125	310	676	504	279	229	616	576	930	-	-	-	-	-	-	959	921	596	121	12
	150	330	676	504	279	229	616	576	930	-	-	-	-	-	-	959	921	596	121	12
	200	362	676	504	279	229	616	576	1143	-	-	-	-	-	-	959	921	596	121	12
	40	320	651	491	229	178	470	459	702	-	-	-	-	-	-	654	616	470	171	12
	50	342	651	491	229	178	470	459	705	-	-	-	-	-	-	654	616	470	171	12
	60	362	651	507	254	203	541	490	787	-	-	-	-	-	-	699	660	545	146	12
6	75	396	651	507	254	203	541	490	787	-	-	-	-	-	-	699	660	545	146	12
	150	317	676	513	279	229	616	576	930	-	-	-	-	-	-	953	914	596	121	12
	200	347	666	513	279	229	616	576	930	-	-	-	-	-	-	953	914	596	171	12
	50	329	666	504	279	178	616	576	1143	-	-	-	-	-	-	648	610	462	171	12
	60	351	641	516	229	203	470	459	705	-	-	-	-	-	-	699	660	545	222	8
	75	379	641	516	254	203	541	490	787	-	-	-	-	-	-	699	660	545	197	12
100	415	641	513	254	229	541	490	787	-	-	-	-	-	-	953	914	596	197	12	

## Dimensions for pumps with ODP motors and support rails

Dimensions in inch.

		Dimensions for pumps with ODP motors and support rails [inch]																			
Pump size	Pole	Actual impeller size [inch]	ODP motor							Support rail under pump						Support rail under motor					
			LP	Q	D	E	T	AB	AG	L7	L8	B7	H5	H7	HG3	L4	L6	B4	H6	HG1	
012-070	3	4.29	13.34	7.81	3.5	2.75	6.88	5.25	12.25	7.75	3.13	10.43	1.00	6.25	0.50	13.29	11.79	8.45	2.75	0.20	
	7.5	4.92	14.64	9.54	4.5	3.75	8.69	5.88	13.25	7.75	3.13	11.42	1.75	7.00	0.20	13.75	12.25	10.45	2.50	0.20	
	7.5	5.71	14.64	9.54	5.25	3.75	10.25	7.38	18.13	7.75	3.13	11.42	1.75	7.00	0.20	13.75	12.25	10.45	1.75	0.20	
	2	7.5	5.87	14.64	9.54	5.25	3.75	10.25	7.38	18.13	7.75	3.13	11.42	1.75	7.00	0.20	13.75	12.25	10.45	1.75	0.20
	15	6.10	14.64	10.42	4.5	4.25	8.69	5.88	13.25	7.75	3.13	11.42	1.75	7.00	0.20	16.66	15.16	11.45	2.50	0.20	
	15	6.42	14.64	10.42	5.25	4.25	10.25	7.38	18.13	7.75	3.13	11.42	1.75	7.00	0.20	16.66	15.16	11.45	1.75	0.20	
	15	6.97	14.64	10.42	5.25	4.25	10.25	7.38	18.13	7.75	3.13	11.42	1.75	7.00	0.20	16.66	15.16	11.45	1.75	0.20	
015-070	1	5.00	13.34	7.81	3.5	2.75	6.88	5.25	12.25	7.75	3.13	10.43	1.00	6.25	0.50	13.29	11.79	8.45	2.75	0.20	
	1	5.56	13.34	7.81	3.5	2.75	6.88	5.25	12.25	7.75	3.13	10.43	1.00	6.25	0.50	13.29	11.79	8.45	2.75	0.20	
	1	6.10	13.34	7.81	3.5	2.75	6.88	5.25	12.25	7.75	3.13	10.43	1.00	6.25	0.50	13.29	11.79	8.45	2.75	0.20	
	1.5	6.97	13.34	7.81	3.5	2.75	6.88	5.25	12.25	7.75	3.13	10.43	1.00	6.25	0.50	13.29	11.79	8.45	2.75	0.20	
	5	4.49	14.64	9.54	4.5	3.75	8.69	5.88	13.25	7.75	3.13	11.42	1.75	7.00	0.20	13.75	12.25	10.45	2.50	0.20	
	7.5	5.04	14.64	9.54	4.5	3.75	8.69	5.88	13.25	7.75	3.13	11.42	1.75	7.00	0.20	13.75	12.25	10.45	2.50	0.20	
	2	10	5.59	14.64	10.42	5.25	4.25	10.25	7.38	18.13	7.75	3.13	11.42	1.75	7.00	0.20	16.66	15.16	11.45	1.75	0.20
015-090	15	6.30	14.64	10.42	5.25	4.25	10.25	7.38	18.13	7.75	3.13	11.42	1.75	7.00	0.20	16.66	15.16	11.45	1.75	0.20	
	20	6.93	14.64	10.24	6.25	5	12.88	9.63	20	7.75	3.13	11.42	1.75	7.00	0.20	20.25	18.75	11.97	0.75	0.38	
	1	4.65	13.34	7.81	3.5	2.75	6.88	5.25	12.25	7.75	3.13	10.43	1.00	6.25	0.50	13.29	11.79	8.45	2.75	0.20	
	1	5.12	13.34	7.81	3.5	2.75	6.88	5.25	12.25	7.75	3.13	10.43	1.00	6.25	0.50	13.29	11.79	8.45	2.75	0.20	
	4	1.5	5.91	13.34	7.81	3.5	2.75	6.88	5.25	12.25	7.75	3.13	10.43	1.00	6.25	0.50	13.29	11.79	8.45	2.75	0.20
	2	6.54	13.34	7.81	3.5	2.75	6.88	5.25	12.25	7.75	3.13	10.43	1.00	6.25	0.50	13.29	11.79	8.45	2.75	0.20	
	3	6.93	14.64	9.54	4.5	3.75	8.69	5.88	13.25	7.75	3.13	11.42	1.75	7.00	0.20	13.75	12.25	10.45	2.50	0.20	
015-095	15	7.09	15.52	11.69	5.25	4.25	10.25	7.38	18.13	-	-	-	-	-	-	16.66	15.16	11.45	1.75	0.20	
	20	7.80	17.13	12.11	6.25	5	12.88	9.63	20	8.75	3.63	12.80	1.00	8.00	0.50	20.00	18.50	12.95	1.75	0.20	
	2	25	8.27	17.13	12.11	6.25	5	12.88	9.63	20	8.75	3.63	12.80	1.00	8.00	0.50	20.00	18.50	12.95	1.75	0.20
	30	8.82	15.44	10.17	7	5.5	14.63	13.13	21.5	8.75	3.63	12.80	1.00	8.00	0.50	22.25	20.75	13.95	1.00	0.50	
	40	9.84	15.44	10.17	7	5.5	14.63	13.13	21.5	8.75	3.63	12.80	1.00	8.00	0.50	22.25	20.75	13.95	1.00	0.50	
	1.5	6.69	14.22	9.08	3.5	2.75	6.88	5.25	12.25	-	-	-	-	-	-	14.29	12.79	8.45	3.50	0.20	
	2	7.24	14.22	9.08	3.5	2.75	6.88	5.25	12.25	-	-	-	-	-	-	14.29	12.79	8.45	3.50	0.20	
015-095	4	3	8.11	15.52	10.81	4.5	3.75	8.69	5.88	13.25	-	-	-	-	-	14.66	13.16	10.45	2.50	0.20	
	5	9.84	15.52	10.81	4.5	3.75	8.69	5.88	13.25	-	-	-	-	-	14.66	13.16	10.45	2.50	0.20		
	15	6.46	15.52	11.69	5.25	4.25	10.25	7.38	18.13	-	-	-	-	-	16.66	15.16	11.45	1.75	0.20		
	20	7.01	17.13	12.11	6.25	5	12.88	9.63	20	8.75	3.63	12.80	1.00	8.00	0.50	20.00	18.50	12.95	1.75	0.20	
	2	25	7.48	17.13	12.11	6.25	5	12.88	9.63	20	8.75	3.63	12.80	1.00	8.00	0.50	20.00	18.50	12.95	1.75	0.20
	30	7.87	15.44	10.17	7	5.5	14.63	13.13	21.5	8.75	3.63	12.80	1.00	8.00	0.50	22.25	20.75	13.95	1.00	0.50	
	40	8.82	15.44	10.17	7	5.5	14.63	13.13	21.5	8.75	3.63	12.80	1.00	8.00	0.50	22.25	20.75	13.95	1.00	0.50	
50	9.69	16.34	11.38	8	6.25	16.5	14.13	23	9.00	3.75	13.78	2.00	9.00	0.20	23.50	22.00	15.45	1.00	0.50		
015-095	2	6.54	14.22	9.08	3.5	2.75	6.88	5.25	12.25	-	-	-	-	-	14.29	12.79	8.45	3.50	0.20		
	4	3	7.32	15.52	10.81	4.5	3.75	8.69	5.88	13.25	-	-	-	-	14.66	13.16	10.45	2.50	0.20		
	5	8.82	15.52	10.81	4.5	3.75	8.69	5.88	13.25	-	-	-	-	14.66	13.16	10.45	2.50	0.20			
	7.5	9.84	15.52	11.69	5.25	4.25	10.25	7.38	18.13	-	-	-	-	16.66	15.16	11.45	1.75	0.20			

Dimensions for pumps with ODP motors and support rails [inch]																					
Pump size	Pole	P2 [hp]	Actual impeller size [inch]	ODP motor						Support rail under pump						Support rail under motor					
				LP	Q	D	E	T	AB	AG	L7	L8	B7	H5	H7	HG3	L4	L6	B4	H6	HG1
020-095	2	15	5.75	15.93	12.1	5.25	4.25	10.25	7.38	18.13	-	-	-	-	-	-	16.66	15.16	11.45	1.75	0.20
		20	6.30	17.54	12.52	6.25	5	12.88	9.63	20	8.75	3.63	12.80	1.00	8.00	0.50	20.00	18.50	12.95	1.75	0.20
		25	6.77	17.54	12.52	6.25	5	12.88	9.63	20	8.75	3.63	12.80	1.00	8.00	0.50	20.00	18.50	12.95	1.75	0.20
		30	7.17	15.85	10.58	7	5.5	14.63	13.13	21.5	8.75	3.63	12.80	1.00	8.00	0.50	22.25	20.75	13.95	1.00	0.50
	4	40	8.03	15.85	10.58	7	5.5	14.63	13.13	21.5	8.75	3.63	12.80	1.00	8.00	0.50	22.25	20.75	13.95	1.00	0.50
		50	8.58	16.76	11.8	8	6.25	16.5	14.13	23	9.00	3.75	13.78	2.00	9.00	0.20	23.50	22.00	15.45	1.00	0.50
		60	8.90 <sup>29)</sup>	16.76	11.8	8	6.25	16.5	14.13	23	9.00	3.75	13.78	2.00	9.00	0.20	23.50	22.00	15.45	1.00	0.50
		60	9.45 <sup>30)</sup>	16.76	11.8	8	6.25	16.5	14.13	23	9.00	3.75	13.78	2.00	9.00	0.20	23.50	22.00	15.45	1.00	0.50
020-110	2	2	5.83	14.22	9.08	3.5	2.75	6.88	5.25	12.25	-	-	-	-	-	-	14.29	12.79	8.45	3.50	0.20
		3	6.61	15.52	10.81	4.5	3.75	8.69	5.88	13.25	-	-	-	-	-	-	14.66	13.16	10.45	2.50	0.20
	4	5	8.11	15.52	10.81	4.5	3.75	8.69	5.88	13.25	-	-	-	-	-	-	14.66	13.16	10.45	2.50	0.20
		7.5	9.45	15.52	11.69	5.25	4.25	10.25	7.38	18.13	-	-	-	-	-	-	16.66	15.16	11.45	1.75	0.20
020-135	2	5	8.11	15.52	10.81	4.5	3.75	8.69	5.88	13.25	-	-	-	-	-	-	14.66	13.16	10.45	2.50	0.20
		7.5	8.98	15.52	11.69	5.25	4.25	10.25	7.38	18.13	-	-	-	-	-	-	16.66	15.16	11.45	1.75	0.20
	4	10	9.92	15.52	11.69	5.25	4.25	10.25	7.38	18.13	-	-	-	-	-	-	16.66	15.16	11.45	1.75	0.20
		15	10.31	15.52	11.51	6.25	5	12.88	9.63	20	-	-	-	-	-	-	20.25	18.75	11.97	0.75	0.38
025-070	2	7.5	9.29	17.56	12.73	5.25	4.25	10.25	7.38	18.13	-	-	-	-	-	-	16.66	15.16	11.45	3.75	0.20
		10	10.16	17.56	12.73	5.25	4.25	10.25	7.38	18.13	-	-	-	-	-	-	16.66	15.16	11.45	3.75	0.20
	4	15	11.42	17.56	13.3	6.25	5	12.88	9.63	20	-	-	-	-	-	-	20.50	19.00	12.95	2.75	0.20
		20	12.52	17.56	13.3	6.25	5	12.88	9.63	20	-	-	-	-	-	-	20.50	19.00	12.95	2.75	0.20
		25	13.39-13.23	18.94	15.06	7	5.5	14.63	13.13	21.63	-	-	-	-	-	-	21.75	20.25	15.17	2.00	0.31
025-095	2	7.5	4.57	15.52	9.05	4.5	3.75	8.69	5.88	13.25	8.75	3.63	11.30	0.75	7.00	0.38	14.66	13.16	10.45	2.50	0.20
		10	4.96	15.52	9.93	5.25	4.25	10.25	7.38	18.13	8.75	3.63	11.30	0.75	7.00	0.38	16.66	15.16	11.45	1.75	0.20
		15	5.67	15.52	9.93	5.25	4.25	10.25	7.38	18.13	8.75	3.63	11.30	0.75	7.00	0.38	16.66	15.16	11.45	1.75	0.20
		20	6.30	17.13	9.75	6.25	5	12.88	9.63	20	8.75	3.63	11.30	0.75	7.00	0.38	20.25	18.75	11.97	0.75	0.38
		25	6.61	17.13	9.75	6.25	5	12.88	9.63	20	8.75	3.63	11.30	0.75	7.00	0.38	20.25	18.75	11.97	0.75	0.38
	4	30	6.77	15.44	10.05	7	5.5	14.63	13.13	21.5	9.00	3.75	12.28	1.75	8.00	0.20	22.25	20.75	13.95	1.00	0.50
		1	4.65	14.22	9.08	3.5	2.75	6.88	5.25	12.25	-	-	-	-	-	-	13.29	11.79	8.45	2.75	0.20
		1.5	5.28	14.22	9.08	3.5	2.75	6.88	5.25	12.25	-	-	-	-	-	-	13.29	11.79	8.45	2.75	0.20
		2	5.83	14.22	9.08	3.5	2.75	6.88	5.25	12.25	-	-	-	-	-	-	13.29	11.79	8.45	2.75	0.20
		3	6.61	15.52	9.05	4.5	3.75	8.69	5.88	13.25	8.75	3.63	11.30	0.75	7.00	0.38	14.66	13.16	10.45	2.50	0.20
025-135	2	5	6.77	15.52	9.05	4.5	3.75	8.69	5.88	13.25	8.75	3.63	11.30	0.75	7.00	0.38	14.66	13.16	10.45	2.50	0.20
		25	5.98	17.54	13.86	6.25	5	12.88	9.63	20	-	-	-	-	-	-	20.00	18.5	12.95	1.75	0.20
		30	6.30	15.85	11.92	7	5.5	14.63	13.13	21.5	-	-	-	-	-	-	22.25	20.75	13.95	1.00	0.50
		40	7.17	15.85	11.92	7	5.5	14.63	13.13	21.5	-	-	-	-	-	-	22.25	20.75	13.95	1.00	0.50
		50	7.80	16.76	11.05	8	6.25	16.5	14.13	23	10.50	4.50	14.96	1.00	9.00	0.50	23.50	22.00	15.45	1.00	0.50
	4	60	8.43	16.76	11.05	8	6.25	16.5	14.13	23	10.50	4.50	14.96	1.00	9.00	0.50	23.50	22.00	15.45	1.00	0.50
		75	9.37 <sup>29)</sup>	16.76	11.55	9	7	18.5	18.06	25	10.50	4.50	15.94	2.00	10.00	0.20	24.50	23.00	16.95	1.00	0.50
		75	9.53 <sup>30)</sup>	16.76	11.55	9	7	18.5	18.06	25	10.50	4.50	15.94	2.00	10.00	0.20	24.50	23.00	16.95	1.00	0.50
		3	5.98	15.52	10.4	4.5	3.75	8.69	5.88	13.25	-	-	-	-	-	-	14.66	13.16	10.45	3.50	0.20
		5	7.17	15.52	10.4	4.5	3.75	8.69	5.88	13.25	-	-	-	-	-	-	14.66	13.16	10.45	3.50	0.20
025-170	2	7.5	8.43	15.52	11.28	5.25	4.25	10.25	7.38	18.13	-	-	-	-	-	-	16.66	15.16	11.45	2.75	0.20
		10	9.53	15.52	11.28	5.25	4.25	10.25	7.38	18.13	-	-	-	-	-	-	16.66	15.16	11.45	2.75	0.20
		1	6.06	14.22	8.66	3.5	2.75	6.88	5.25	12.25	-	-	-	-	-	-	14.50	13.00	8.45	4.50	0.20
	4	1.5	7.17	15.52	10.4	4.5	3.75	8.69	5.88	13.25	-	-	-	-	-	-	14.66	13.16	10.45	3.50	0.20
		2	8.19	15.52	10.4	4.5	3.75	8.69	5.88	13.25	-	-	-	-	-	-	14.66	13.16	10.45	3.50	0.20
3	9.53	15.52	11.28	5.25	4.25	10.25	7.38	18.13	-	-	-	-	-	-	-	16.66	15.16	11.45	2.75	0.20	



Dimensions for pumps with ODP motors and support rails [inch]																					
Pump size	Pole	P2 [hp]	Actual impeller size [inch]	ODP motor						Support rail under pump						Support rail under motor					
				LP	Q	D	E	T	AB	AG	L7	L8	B7	H5	H7	HG3	L4	L6	B4	H6	HG1
025-110	4	7.5	8.58	17.56	12.24	5.25	4.25	10.25	7.38	18.13	-	-	-	-	-	-	16.66	15.16	11.45	2.75	0.20
		10	9.45	17.56	12.24	5.25	4.25	10.25	7.38	18.13	-	-	-	-	-	-	16.66	15.16	11.45	2.75	0.20
		15	11.02	17.56	12.81	6.25	5	12.88	9.63	20	-	-	-	-	-	-	20.00	18.50	12.95	1.75	0.20
	6	2	8.43	17.56	11.36	4.5	3.75	8.69	5.88	13.25	-	-	-	-	-	-	14.66	13.16	10.45	3.50	0.20
		3	9.61	17.56	12.24	5.25	4.25	10.25	7.38	18.13	-	-	-	-	-	-	16.66	15.16	11.45	2.75	0.20
030-070	2	5	11.02	17.56	12.24	5.25	4.25	10.25	7.38	18.13	-	-	-	-	-	-	16.66	15.16	11.45	2.75	0.20
		15	5.04	15.52	9.93	5.25	4.25	10.25	7.38	18.13	8.75	3.63	11.30	0.75	7.00	0.38	16.66	15.16	11.45	1.75	0.20
		20	5.59	17.13	9.75	6.25	5	12.88	9.63	20	8.75	3.63	11.30	0.75	7.00	0.38	20.25	18.75	11.97	0.75	0.38
		25	5.83	17.13	9.75	6.25	5	12.88	9.63	20	8.75	3.63	11.30	0.75	7.00	0.38	20.25	18.75	11.97	0.75	0.38
		30	6.30	15.44	10.05	7	5.5	14.63	13.13	21.5	9.00	3.75	12.28	1.75	8.00	0.20	22.25	20.75	13.95	1.00	0.50
	4	40	6.85	15.44	10.05	7	5.5	14.63	13.13	21.5	9.00	3.75	12.28	1.75	8.00	0.20	22.25	20.75	13.95	1.00	0.50
		1.5	4.72	14.22	9.08	3.5	2.75	6.88	5.25	12.25	-	-	-	-	-	-	13.29	11.79	8.45	2.75	0.20
		2	5.20	14.22	9.08	3.5	2.75	6.88	5.25	12.25	-	-	-	-	-	-	13.29	11.79	8.45	2.75	0.20
		3	5.83	15.52	9.05	4.5	3.75	8.69	5.88	13.25	8.75	3.63	11.30	0.75	7.00	0.38	14.66	13.16	10.45	2.50	0.20
		5	6.85	15.52	9.05	4.5	3.75	8.69	5.88	13.25	8.75	3.63	11.30	0.75	7.00	0.38	14.66	13.16	10.45	2.50	0.20
030-095	2	40	6.10	17.64	12.64	7	5.5	14.63	13.13	21.5	-	-	-	-	-	-	22.25	20.75	13.95	1.00	0.50
		50	6.50	18.54	11.83	8	6.25	16.5	14.13	23	10.50	4.50	16.34	1.00	9.00	0.50	23.50	22.00	15.45	1.00	0.50
		60	6.89	18.54	11.83	8	6.25	16.5	14.13	23	10.50	4.50	16.34	1.00	9.00	0.50	23.50	22.00	15.45	1.00	0.50
		75	7.36	18.54	12.33	9	7	18.5	18.06	25	10.50	4.50	17.32	2.00	10.00	0.20	24.50	23.00	16.95	1.00	0.50
		100	8.07	18.54	12.33	9	7	18.5	18.06	25	10.50	4.50	17.32	2.00	10.00	0.20	24.50	23.00	16.95	1.00	0.50
		125	8.86	18.54	13.33	10	8	21.31	19.31	27.75	10.00	4.25	17.32	3.00	11.00	0.20	27.50	26.00	19.94	1.00	0.50
030-110	4	5	6.10	17.3	11.1	4.5	3.75	8.69	5.88	13.25	-	-	-	-	-	-	14.66	13.16	10.45	3.50	0.20
		7.5	6.73	17.3	11.98	5.25	4.25	10.25	7.38	18.13	-	-	-	-	-	-	16.66	15.16	11.45	2.75	0.20
		10	7.52	17.3	11.98	5.25	4.25	10.25	7.38	18.13	-	-	-	-	-	-	16.66	15.16	11.45	2.75	0.20
		15	8.86	17.3	12.55	6.25	5	12.88	9.63	20	-	-	-	-	-	-	20.00	18.50	12.95	1.75	0.20
		1.5	6.02	17.3	11.1	4.5	3.75	8.69	5.88	13.25	-	-	-	-	-	-	14.66	13.16	10.45	3.50	0.20
030-135	6	2	6.57	17.3	11.1	4.5	3.75	8.69	5.88	13.25	-	-	-	-	-	-	14.66	13.16	10.45	3.50	0.20
		3	7.52	17.3	11.98	5.25	4.25	10.25	7.38	18.13	-	-	-	-	-	-	16.66	15.16	11.45	2.75	0.20
		5	8.86	17.3	11.98	5.25	4.25	10.25	7.38	18.13	-	-	-	-	-	-	16.66	15.16	11.45	2.75	0.20
		10	8.50-8.19	17.56	12.24	5.25	4.25	10.25	7.38	18.13	-	-	-	-	-	-	16.66	15.16	11.45	2.75	0.20
030-135	4	15	9.76-9.45	17.56	12.81	6.25	5	12.88	9.63	20	-	-	-	-	-	-	20.00	18.50	12.95	1.75	0.20
		20	10.94-10.63	17.56	12.81	6.25	5	12.88	9.63	20	-	-	-	-	-	-	20.00	18.50	12.95	1.75	0.20
		3	8.58-8.27	17.56	12.24	5.25	4.25	10.25	7.38	18.13	-	-	-	-	-	-	16.66	15.16	11.45	2.75	0.20
		5	10.47-10.16	17.56	12.24	5.25	4.25	10.25	7.38	18.13	-	-	-	-	-	-	16.66	15.16	11.45	2.75	0.20
		7.5	10.94-10.63	17.56	12.81	6.25	5	12.88	9.63	20	-	-	-	-	-	-	20.00	18.50	12.95	1.75	0.20
	6	15	8.98	17.56	12.81	6.25	5	12.88	9.63	20	-	-	-	-	-	-	21.00	19.50	12.95	3.75	0.20
		20	9.92	17.56	12.81	6.25	5	12.88	9.63	20	-	-	-	-	-	-	21.00	19.50	12.95	3.75	0.20
		25	10.63	18.94	14.57	7	5.5	14.63	13.13	21.63	-	-	-	-	-	-	22.25	20.75	15.17	3.00	0.31
		30	11.26	18.94	14.57	7	5.5	14.63	13.13	21.63	-	-	-	-	-	-	22.25	20.75	15.17	3.00	0.31
		40	12.91	19.88	15.95	8	6.25	16.5	14.13	23.75	-	-	-	-	-	-	23.25	21.75	16.67	2.00	0.31
030-135	6	5	8.98	17.56	12.24	5.25	4.25	10.25	7.38	18.13	-	-	-	-	-	-	17.50	16.00	11.45	4.75	0.20
		7.5	10.55	17.56	12.81	6.25	5	12.88	9.63	20	-	-	-	-	-	-	21.00	19.50	12.95	3.75	0.20
		10	11.73	17.56	12.81	6.25	5	12.88	9.63	20	-	-	-	-	-	-	21.00	19.50	12.95	3.75	0.20
		15	12.91	18.94	14.57	7	5.5	14.63	13.13	21.63	-	-	-	-	-	-	22.25	20.75	15.17	3.00	0.31

Dimensions for pumps with ODP motors and support rails [inch]																				
Pump size	Pole	P2 [hp]	Actual impeller size [inch]	ODP motor						Support rail under pump						Support rail under motor				
				LP	Q	D	E	T	AB	AG	L7	L8	B7	H5	H7	HG3	L4	L6	B4	H6
2	20	5.43-4.80	18.13	12.11	6.25	5	12.88	9.63	20	8.75	3.63	13.98	1.00	8.00	0.50	20.00	18.50	12.95	1.75	0.20
	25	5.51	18.13	12.11	6.25	5	12.88	9.63	20	8.75	3.63	13.98	1.00	8.00	0.50	20.00	18.50	12.95	1.75	0.20
	30	5.75	16.44	10.17	7	5.5	14.63	13.13	21.5	8.75	3.63	13.98	1.00	8.00	0.50	22.25	20.75	13.95	1.00	0.50
	40	6.30	16.44	10.17	7	5.5	14.63	13.13	21.5	8.75	3.63	13.98	1.00	8.00	0.50	22.25	20.75	13.95	1.00	0.50
	50	6.77	17.34	11.38	8	6.25	16.5	14.13	23	9.00	3.75	14.96	2.00	9.00	0.20	23.50	22.00	15.45	1.00	0.50
040-070	2	5.12-4.33	15.22	9.08	3.5	2.75	6.88	5.25	12.25	-	-	-	-	-	-	14.29	12.79	8.45	3.50	0.20
	3	5.43	16.52	10.81	4.5	3.75	8.69	5.88	13.25	-	-	-	-	-	-	14.66	13.16	10.45	2.50	0.20
	5	6.30	16.52	10.81	4.5	3.75	8.69	5.88	13.25	-	-	-	-	-	-	14.66	13.16	10.45	2.50	0.20
	7.5	6.85	16.52	11.69	5.25	4.25	10.25	7.38	18.13	-	-	-	-	-	-	16.66	15.16	11.45	1.75	0.20
	0.75	5.12-4.80	15.22	9.08	3.5	2.75	6.88	5.25	12.25	-	-	-	-	-	-	14.29	12.79	8.45	3.50	0.20
6	1	5.51	15.22	9.08	3.5	2.75	6.88	5.25	12.25	-	-	-	-	-	-	14.29	12.79	8.45	3.50	0.20
	1.5	6.14	16.52	10.81	4.5	3.75	8.69	5.88	13.25	-	-	-	-	-	-	14.66	13.16	10.45	2.50	0.20
	2	6.85	16.52	10.81	4.5	3.75	8.69	5.88	13.25	-	-	-	-	-	-	14.66	13.16	10.45	2.50	0.20
2	60	6.46	19.04	13.97	8	6.25	16.5	14.13	23	-	-	-	-	-	-	23.50	22.00	15.45	1.00	0.50
	75	6.93	19.04	12.33	9	7	18.5	18.06	25	10.50	4.50	16.34	1.00	10.00	0.50	24.50	23.00	16.95	1.00	0.50
	100	7.72	19.04	12.33	9	7	18.5	18.06	25	10.50	4.50	16.34	1.00	10.00	0.50	24.50	23.00	16.95	1.00	0.50
	125	8.35	19.04	13.08	10	8	21.31	19.31	27.75	10.50	4.50	17.32	2.00	11.00	0.20	27.50	26.00	19.94	1.00	0.50
	7.5	6.38	17.8	11.98	5.25	4.25	10.25	7.38	18.13	-	-	-	-	-	-	16.66	15.16	11.45	3.75	0.20
040-095	4	10	7.09	17.8	11.98	5.25	4.25	10.25	7.38	18.13	-	-	-	-	-	16.66	15.16	11.45	3.75	0.20
	15	8.35	17.8	12.55	6.25	5	12.88	9.63	20	-	-	-	-	-	-	20.50	19.00	12.95	2.75	0.20
	20	9.37	17.8	12.55	6.25	5	12.88	9.63	20	-	-	-	-	-	-	20.50	19.00	12.95	2.75	0.20
	2	6.30	17.8	11.1	4.5	3.75	8.69	5.88	13.25	-	-	-	-	-	-	15.25	13.75	10.45	4.50	0.20
	3	7.09	17.8	11.98	5.25	4.25	10.25	7.38	18.13	-	-	-	-	-	-	16.66	15.16	11.45	3.75	0.20
6	5	8.98	17.8	11.98	5.25	4.25	10.25	7.38	18.13	-	-	-	-	-	-	16.66	15.16	11.45	3.75	0.20
	7.5	9.37	17.8	12.55	6.25	5	12.88	9.63	20	-	-	-	-	-	-	20.50	19.00	12.95	2.75	0.20
	15	8.11	18.06	12.81	6.25	5	12.88	9.63	20	-	-	-	-	-	-	20.50	19.00	12.95	2.75	0.20
	20	8.74	18.06	12.81	6.25	5	12.88	9.63	20	-	-	-	-	-	-	20.50	19.00	12.95	2.75	0.20
	25	9.45	19.44	14.57	7	5.5	14.63	13.13	21.63	-	-	-	-	-	-	21.75	20.25	15.17	2.00	0.31
040-110	4	30	10.08	19.44	14.57	7	5.5	14.63	13.13	21.63	-	-	-	-	-	21.75	20.25	15.17	2.00	0.31
	3	7.17	18.06	12.24	5.25	4.25	10.25	7.38	18.13	-	-	-	-	-	-	16.66	15.16	11.45	3.75	0.20
	5	8.35	18.06	12.24	5.25	4.25	10.25	7.38	18.13	-	-	-	-	-	-	16.66	15.16	11.45	3.75	0.20
	7.5	9.37	18.06	12.81	6.25	5	12.88	9.63	20	-	-	-	-	-	-	20.50	19.00	12.95	2.75	0.20
	10	10.08	18.06	12.81	6.25	5	12.88	9.63	20	-	-	-	-	-	-	20.50	19.00	12.95	2.75	0.20
040-135	20	9.29	18.06	12.88	6.25	5	12.88	9.63	20	-	-	-	-	-	-	21.00	19.50	12.95	3.75	0.20
	25	10.24	19.44	14.64	7	5.5	14.63	13.13	21.63	-	-	-	-	-	-	22.25	20.75	15.17	3.00	0.31
	4	30	10.94	19.44	14.64	7	5.5	14.63	13.13	21.63	-	-	-	-	-	22.25	20.75	15.17	3.00	0.31
	40	11.81	20.38	16.02	8	6.25	16.5	14.13	23.75	-	-	-	-	-	-	23.25	21.75	16.67	2.00	0.31
	50	12.83	20.38	16.02	8	6.25	16.5	14.13	23.75	-	-	-	-	-	-	23.25	21.75	16.67	2.00	0.31
	5	8.74	18.06	12.32	5.25	4.25	10.25	7.38	18.13	-	-	-	-	-	-	17.50	16.00	11.45	4.75	0.20
	7.5	10.16	18.06	12.88	6.25	5	12.88	9.63	20	-	-	-	-	-	-	21.00	19.50	12.95	3.75	0.20
6	10	11.18	18.06	12.88	6.25	5	12.88	9.63	20	-	-	-	-	-	21.00	19.50	12.95	3.75	0.20	
15	12.60	19.44	14.64	7	5.5	14.63	13.13	21.63	-	-	-	-	-	-	22.25	20.75	15.17	3.00	0.31	

Dimensions for pumps with ODP motors and support rails [inch]																					
Pump size	Pole	P2 [hp]	Actual impeller size [inch]	ODP motor						Support rail under pump						Support rail under motor					
				LP	Q	D	E	T	AB	AG	L7	L8	B7	H5	H7	HG3	L4	L6	B4	H6	HG1
040-150	4	50	12.21	21.52	16.49	8	6.25	16.5	14.13	23.75	-	-	-	-	-	-	24.25	22.75	16.67	3.00	0.31
		60	12.91	21.52	17.12	9	7	18.5	18.06	24.88	-	-	-	-	-	-	24.50	23.00	18.17	2.00	0.31
		75	13.86	21.52	17.12	9	7	18.5	18.06	24.88	-	-	-	-	-	-	24.50	23.00	18.17	2.00	0.31
		100	15.20	23.02	18.61	10	8	21.31	19.31	30.75	-	-	-	-	-	-	27.50	26.00	19.94	1.00	0.50
		125	16.06	23.02	18.61	10	8	21.31	19.31	30.75	-	-	-	-	-	-	27.50	26.00	19.94	1.00	0.50
		150	16.77	25.03	18.23	11	9	24.24	22.68	31.63	11.50	5.00	19.69	1.00	12.00	0.50	29.50	28.00	21.94	1.00	0.50
	6	15	11.97	20.85	15.38	7	5.5	14.63	13.13	21.63	-	-	-	-	-	-	22.75	21.25	15.17	4.00	0.31
		20	13.39	20.85	15.38	7	5.5	14.63	13.13	21.63	-	-	-	-	-	-	22.75	21.25	15.17	4.00	0.31
		25	14.49	21.52	16.49	8	6.25	16.5	14.13	23.75	-	-	-	-	-	-	24.25	22.75	16.67	3.00	0.31
		30	15.28	21.52	16.49	8	6.25	16.5	14.13	23.75	-	-	-	-	-	-	24.25	22.75	16.67	3.00	0.31
		40	16.77	21.52	17.12	9	7	18.5	18.06	24.88	-	-	-	-	-	-	24.50	23.00	18.17	2.00	0.31
		25	5.59-4.49	18.13	13.38	6.25	5	12.88	9.63	20	-	-	-	-	-	-	20.00	18.50	12.95	1.75	0.20
050-070	2	30	5.98-4.88	16.44	11.44	7	5.5	14.63	13.13	21.5	-	-	-	-	-	-	22.25	20.75	13.95	1.00	0.50
		40	6.06	16.44	11.44	7	5.5	14.63	13.13	21.5	-	-	-	-	-	-	22.25	20.75	13.95	1.00	0.50
		50	6.46	17.34	10.63	8	6.25	16.5	14.13	23	10.50	4.50	14.96	1.00	9.00	0.50	23.50	22.00	15.45	1.00	0.50
		60	6.77	17.34	10.63	8	6.25	16.5	14.13	23	10.50	4.50	14.96	1.00	9.00	0.50	23.50	22.00	15.45	1.00	0.50
		75	6.93	17.34	11.13	9	7	18.5	18.06	25	10.50	4.50	15.94	2.00	10.00	0.20	24.50	23.00	16.95	1.00	0.50
		3	5.43-4.33	16.52	10.32	4.5	3.75	8.69	5.88	13.25	-	-	-	-	-	-	14.66	13.16	10.45	3.50	0.20
	4	5	6.06	16.52	10.32	4.5	3.75	8.69	5.88	13.25	-	-	-	-	-	-	14.66	13.16	10.45	3.50	0.20
		7.5	6.61	16.52	11.2	5.25	4.25	10.25	7.38	18.13	-	-	-	-	-	-	16.66	15.16	11.45	2.75	0.20
		10	6.93	16.52	11.2	5.25	4.25	10.25	7.38	18.13	-	-	-	-	-	-	16.66	15.16	11.45	2.75	0.20
		0.75	5.28-4.17	15.22	8.59	3.5	2.75	6.88	5.25	12.25	-	-	-	-	-	-	14.50	13.00	8.45	4.50	0.20
		1	5.91-4.17	15.22	8.59	3.5	2.75	6.88	5.25	12.25	-	-	-	-	-	-	14.50	13.00	8.45	4.50	0.20
		1.5	6.06	16.52	10.32	4.5	3.75	8.69	5.88	13.25	-	-	-	-	-	-	14.66	13.16	10.45	3.50	0.20
050-095	6	2	6.61	16.52	10.32	4.5	3.75	8.69	5.88	13.25	-	-	-	-	-	-	14.66	13.16	10.45	3.50	0.20
		3	6.93	16.52	11.2	5.25	4.25	10.25	7.38	18.13	-	-	-	-	-	-	16.66	15.16	11.45	2.75	0.20
		10	6.85-6.06	19.83	14.01	5.25	4.25	10.25	7.38	18.13	-	-	-	-	-	-	17.50	16.00	11.45	4.75	0.20
		15	7.40	19.83	14.58	6.25	5	12.88	9.63	20	-	-	-	-	-	-	21.00	19.50	12.95	3.75	0.20
		20	8.19	19.83	14.58	6.25	5	12.88	9.63	20	-	-	-	-	-	-	21.00	19.50	12.95	3.75	0.20
		25	8.74	20.34	15.47	7	5.5	14.63	13.13	21.63	-	-	-	-	-	-	22.25	20.75	15.17	3.00	0.31
	4	30	9.13	20.34	15.47	7	5.5	14.63	13.13	21.63	-	-	-	-	-	-	22.25	20.75	15.17	3.00	0.31
		3	6.85-6.06	19.83	14.01	5.25	4.25	10.25	7.38	18.13	-	-	-	-	-	-	17.50	16.00	11.45	3.00	0.20
		5	7.72	19.83	14.01	5.25	4.25	10.25	7.38	18.13	-	-	-	-	-	-	17.50	16.00	11.45	4.75	0.20
		7.5	8.74	19.83	14.58	6.25	5	12.88	9.63	20	-	-	-	-	-	-	21.00	19.50	12.95	3.75	0.20
		10	9.13	19.83	14.58	6.25	5	12.88	9.63	20	-	-	-	-	-	-	21.00	19.50	12.95	3.75	0.20
		20	8.35	18.06	12.81	6.25	5	12.88	9.63	20	-	-	-	-	-	-	21.00	19.50	12.95	3.75	0.20
050-110	4	25	9.06	19.44	14.57	7	5.5	14.63	13.13	21.63	-	-	-	-	-	-	22.25	20.75	15.17	3.00	0.31
		30	9.61	19.44	14.57	7	5.5	14.63	13.13	21.63	-	-	-	-	-	-	22.25	20.75	15.17	3.00	0.31
		40	10.63	20.38	15.95	8	6.25	16.5	14.13	23.75	-	-	-	-	-	-	23.25	21.75	16.67	2.00	0.31
		5	8.11	18.06	12.24	5.25	4.25	10.25	7.38	18.13	-	-	-	-	-	-	17.50	16.00	11.45	4.75	0.20
		7.5	8.90	18.06	12.81	6.25	5	12.88	9.63	20	-	-	-	-	-	-	21.00	19.50	12.95	3.75	0.20
		10	10.00	18.06	12.81	6.25	5	12.88	9.63	20	-	-	-	-	-	-	21.00	19.50	12.95	3.75	0.20
	6	15	10.63	19.44	14.57	7	5.5	14.63	13.13	21.63	-	-	-	-	-	-	22.25	20.75	15.17	3.00	0.31

Dimensions for pumps with ODP motors and support rails [inch]																					
Pump size	Pole	P2 [hp]	Actual impeller size [inch]	ODP motor						Support rail under pump					Support rail under motor						
				LP	Q	D	E	T	AB	AG	L7	L8	B7	H5	H7	HG3	L4	L6	B4	H6	HG1
050-135	4	25	8.86	20.85	15.38	7	5.5	14.63	13.13	21.63	-	-	-	-	-	-	22.75	21.25	15.17	4.00	0.31
		30	9.49	20.85	15.38	7	5.5	14.63	13.13	21.63	-	-	-	-	-	-	22.75	21.25	15.17	4.00	0.31
		40	10.59	21.52	16.49	8	6.25	16.5	14.13	23.75	-	-	-	-	-	-	24.25	22.75	16.67	3.00	0.31
	6	50	11.30	21.52	16.49	8	6.25	16.5	14.13	23.75	-	-	-	-	-	-	24.25	22.75	16.67	3.00	0.31
		60	12.01	21.52	17.12	9	7	18.5	18.06	24.88	-	-	-	-	-	-	24.50	23.00	18.17	2.00	0.31
		75	13.11-12.95	21.52	17.12	9	7	18.5	18.06	24.88	-	-	-	-	-	-	24.50	23.00	18.17	2.00	0.31
		10	9.80	20.26	14.41	6.25	5	12.88	9.63	20	-	-	-	-	-	-	21.50	20.00	12.95	4.75	0.20
050-150	4	15	11.30	20.85	15.38	7	5.5	14.63	13.13	21.63	-	-	-	-	-	-	22.75	21.25	15.17	4.00	0.31
		20	12.48	20.85	15.38	7	5.5	14.63	13.13	21.63	-	-	-	-	-	-	22.75	21.25	15.17	4.00	0.31
		75	11.73	21.52	17.18	9	7	18.5	18.06	24.88	-	-	-	-	-	-	25.25	23.75	18.17	3.50	0.31
	6	100	12.99	23.02	19.08	10	8	21.31	19.31	30.75	-	-	-	-	-	-	27.00	25.50	21.47	2.50	0.47
		125	14.09	23.02	19.08	10	8	21.31	19.31	30.75	-	-	-	-	-	-	27.00	25.50	21.47	2.50	0.47
		150	14.96	25.03	20.16	11	9	24.24	22.68	31.63	-	-	-	-	-	-	37.00	35.50	23.16	1.50	0.31
		25	12.28	21.52	16.55	8	6.25	16.5	14.13	23.75	-	-	-	-	-	-	23.75	22.25	16.67	4.50	0.31
6	30	13.15	21.52	16.55	8	6.25	16.5	14.13	23.75	-	-	-	-	-	-	23.75	22.25	16.67	4.50	0.31	
	40	14.49	21.52	17.18	9	7	18.5	18.06	24.88	-	-	-	-	-	-	25.25	23.75	18.17	3.50	0.31	
	50	15.59	21.52	17.18	9	7	18.5	18.06	24.88	-	-	-	-	-	-	25.25	23.75	18.17	3.50	0.31	
	60	16.14	23.02	19.08	10	8	21.31	19.31	30.75	-	-	-	-	-	-	27.00	25.50	21.47	2.50	0.47	
060-095	4	15	7.32	20.58	13.98	6.25	5	12.88	9.63	20	-	-	-	-	-	-	21.50	20.00	12.95	4.75	0.20
		20	7.95	20.58	13.98	6.25	5	12.88	9.63	20	-	-	-	-	-	-	21.50	20.00	12.95	4.75	0.20
		25	8.43	21.09	14.87	7	5.5	14.63	13.13	21.63	-	-	-	-	-	-	22.75	21.25	15.17	4.00	0.31
	6	30	8.90	21.09	14.87	7	5.5	14.63	13.13	21.63	-	-	-	-	-	-	22.75	21.25	15.17	4.00	0.31
		40	9.53	21.72	15.94	8	6.25	16.5	14.13	23.75	-	-	-	-	-	-	24.25	22.75	16.67	3.00	0.31
		5	7.56	20.58	13.42	5.25	4.25	10.25	7.38	18.13	-	-	-	-	-	-	17.50	16.00	11.45	5.75	0.20
		7.5	8.35	20.58	13.98	6.25	5	12.88	9.63	20	-	-	-	-	-	-	21.50	20.00	12.95	4.75	0.20
060-110	4	10	9.21	20.58	13.98	6.25	5	12.88	9.63	20	-	-	-	-	-	-	21.50	20.00	12.95	4.75	0.20
		15	9.53	21.09	14.87	7	5.5	14.63	13.13	21.63	-	-	-	-	-	-	22.75	21.25	15.17	4.00	0.31
		30	8.78	21.6	15.38	7	5.5	14.63	13.13	21.63	-	-	-	-	-	-	22.75	21.25	15.17	4.00	0.31
	6	40	9.57	22.27	16.49	8	6.25	16.5	14.13	23.75	-	-	-	-	-	-	24.25	22.75	16.67	3.00	0.31
		50	10.20	22.27	16.49	8	6.25	16.5	14.13	23.75	-	-	-	-	-	-	24.25	22.75	16.67	3.00	0.31
		60	10.75	22.27	17.12	9	7	18.5	18.06	24.88	-	-	-	-	-	-	24.50	23.00	18.17	2.00	0.31
		7.5	8.39	21.01	14.41	6.25	5	12.88	9.63	20	-	-	-	-	-	-	21.50	20.00	12.95	4.75	0.20
060-135	4	10	9.17	21.01	14.41	6.25	5	12.88	9.63	20	-	-	-	-	-	-	21.50	20.00	12.95	4.75	0.20
		15	10.20	21.6	15.38	7	5.5	14.63	13.13	21.63	-	-	-	-	-	-	22.75	21.25	15.17	4.00	0.31
		20	10.75	21.6	15.38	7	5.5	14.63	13.13	21.63	-	-	-	-	-	-	22.75	21.25	15.17	4.00	0.31
	6	40	9.25	22.27	16.49	8	6.25	16.5	14.13	23.75	-	-	-	-	-	-	24.25	22.75	16.67	3.00	0.31
		50	9.96	22.27	16.49	8	6.25	16.5	14.13	23.75	-	-	-	-	-	-	24.25	22.75	16.67	3.00	0.31
		60	10.35	22.27	17.12	9	7	18.5	18.06	24.88	-	-	-	-	-	-	24.50	23.00	18.17	2.00	0.31
		75	11.22	22.27	17.12	9	7	18.5	18.06	24.88	-	-	-	-	-	-	24.50	23.00	18.17	2.00	0.31
060-135	4	100	12.24	23.77	18.61	10	8	21.31	19.31	30.75	-	-	-	-	-	-	27.50	26.00	19.94	1.00	0.50
		125	12.91-12.76	23.77	18.61	10	8	21.31	19.31	30.75	-	-	-	-	-	-	27.50	26.00	19.94	1.00	0.50
		10	8.70	21.01	14.41	6.25	5	12.88	9.63	20	-	-	-	-	-	-	21.50	20.00	12.95	4.75	0.20
	6	15	9.80	21.6	15.38	7	5.5	14.63	13.13	21.63	-	-	-	-	-	-	22.75	21.25	15.17	4.00	0.31
		20	10.75	21.6	15.38	7	5.5	14.63	13.13	21.63	-	-	-	-	-	-	22.75	21.25	15.17	4.00	0.31
		25	11.54	22.27	16.49	8	6.25	16.5	14.13	23.75	-	-	-	-	-	-	24.25	22.75	16.67	3.00	0.31
		30	12.48-12.32	22.27	16.49	8	6.25	16.5	14.13	23.75	-	-	-	-	-	-	24.25	22.75	16.67	3.00	0.31

Dimensions for pumps with ODP motors and support rails [inch]																					
Pump size	Pole	P2 [hp]	Actual impeller size [inch]	ODP motor						Support rail under pump						Support rail under motor					
				LP	Q	D	E	T	AB	AG	L7	L8	B7	H5	H7	HG3	L4	L6	B4	H6	HG1
060-150	4	125	11.97	24.64	19.95	10	8	21.31	19.31	30.75	-	-	-	-	-	-	27.00	25.50	21.47	2.50	0.47
		150	12.83	25.62	20	11	9	24.24	22.68	31.63	-	-	-	-	-	-	37.00	35.50	23.16	1.50	0.31
		200	14.80	25.62	20	11	9	24.24	22.68	31.63	-	-	-	-	-	-	37.00	35.50	23.16	1.50	0.31
		250	15.83	25.62	20	11	9	24.24	22.68	39.75	-	-	-	-	-	-	37.00	35.50	23.16	1.50	0.31
	6	40	12.44	24.64	19.55	9	7	18.5	18.06	24.88	-	-	-	-	-	-	25.25	23.75	18.17	3.50	0.31
		50	13.70	24.64	19.55	9	7	18.5	18.06	24.88	-	-	-	-	-	-	25.25	23.75	18.17	3.50	0.31
		60	14.88	24.64	19.95	10	8	21.31	19.31	30.75	-	-	-	-	-	-	27.00	25.50	21.47	2.50	0.47
		75	16.06	24.64	19.95	10	8	21.31	19.31	30.75	-	-	-	-	-	-	27.00	25.50	21.47	2.50	0.47
		100	16.93	25.62	20	11	9	24.24	22.68	31.63	-	-	-	-	-	-	37.00	35.50	23.16	1.50	0.31
		60	9.84	22.27	17.12	9	7	18.5	18.06	24.88	-	-	-	-	-	-	24.50	23.00	18.17	4.75	0.31
080-135	4	75	10.31	22.27	17.12	9	7	18.5	18.06	24.88	-	-	-	-	-	-	24.50	23.00	18.17	4.75	0.31
		100	11.26	23.77	19.24	10	8	21.31	19.31	30.75	-	-	-	-	-	-	26.25	24.75	20.17	3.75	0.31
		125	11.89	23.77	19.24	10	8	21.31	19.31	30.75	-	-	-	-	-	-	26.25	24.75	20.17	3.75	0.31
		150	12.60	25.78	20	11	9	24.24	22.68	31.63	-	-	-	-	-	-	31.75	30.25	23.47	2.75	0.47
	6	15	9.29	21.6	15.38	7	5.5	14.63	13.13	21.63	-	-	-	-	-	-	22.75	21.25	15.17	6.75	0.31
		20	10.16	21.6	15.38	7	5.5	14.63	13.13	21.63	-	-	-	-	-	-	22.75	21.25	15.17	6.75	0.31
		25	10.79	22.27	16.49	8	6.25	16.5	14.13	23.75	-	-	-	-	-	-	24.25	22.75	16.67	5.75	0.31
		30	11.26	22.27	16.49	8	6.25	16.5	14.13	23.75	-	-	-	-	-	-	24.25	22.75	16.67	5.75	0.31
		40	12.28	22.27	17.12	9	7	18.5	18.06	24.88	-	-	-	-	-	-	24.50	23.00	18.17	4.75	0.31
		50	13.15	22.27	17.12	9	7	18.5	18.06	24.88	-	-	-	-	-	-	24.50	23.00	18.17	4.75	0.31
080-150	4	125	12.20	25.64	19.95	10	8	21.31	19.31	30.75	-	-	-	-	-	-	27.50	26.00	21.47	5.75	0.47
		150	12.99	26.62	19.84	11	9	24.24	22.68	31.63	-	-	-	-	-	-	37.75	36.25	23.47	4.75	0.47
		200	14.25	26.62	19.84	11	9	24.24	22.68	31.63	-	-	-	-	-	-	37.75	36.25	23.47	4.75	0.47
		250	15.59	26.62	19.84	11	9	24.24	22.68	39.75	-	-	-	-	-	-	37.75	36.25	23.47	4.75	0.47
	6	40	12.60	25.64	19.33	9	7	18.5	18.06	24.88	-	-	-	-	-	-	25.75	24.25	18.49	6.75	0.47
		50	13.46	25.64	19.33	9	7	18.5	18.06	24.88	-	-	-	-	-	-	25.75	24.25	18.49	6.75	0.47
		60	14.25	25.64	19.95	10	8	21.31	19.31	30.75	-	-	-	-	-	-	27.50	26.00	21.47	5.75	0.47
100-150	4	75	15.59	25.64	19.95	10	8	21.31	19.31	30.75	-	-	-	-	-	-	27.50	26.00	21.47	5.75	0.47
		150	12.48	26.62	20.19	11	9	24.24	22.68	31.63	-	-	-	-	-	-	37.50	36.00	23.47	4.75	0.47
		200	13.66	26.22	20.19	11	9	24.24	22.68	31.63	-	-	-	-	-	-	37.50	36.00	23.47	6.75	0.47
		250	14.76	26.22	20.19	11	9	24.24	22.68	31.63	-	-	-	-	-	-	37.50	36.00	23.47	6.75	0.47
	6	50	12.95	26.22	19.84	11	7	24.24	22.68	39.75	-	-	-	-	-	-	25.50	24.00	18.17	6.75	0.47
		60	13.82	25.24	20.31	9	8	18.5	18.06	24.88	-	-	-	-	-	-	27.50	26.00	21.47	8.75	0.31
		75	14.92	25.24	20.31	10	8	21.31	19.31	30.75	-	-	-	-	-	-	27.50	26.00	21.47	7.75	0.47
100	16.34	25.24	20.19	10	9	21.31	19.31	30.75	-	-	-	-	-	-	37.50	36.00	23.47	7.75	0.47		

29) Low pressure (Class 125) pump.  
 30) High pressure (Class 300) pump.

## Dimensions in mm.

		Dimensions for pumps with ODP motors and support rails [mm]																				
Pump size	Pole	P2 [hp]	Actual impeller size [mm]	ODP motor						Support rail under pump					Support rail under motor							
				LP	Q	D	E	T	AB	AG	L7	L8	B7	H5	H7	HG3	L4	L6	B4	H6	HG1	
012-070	3	109	339	198	89	70	175	133	311	197	80	265	25	159	13	338	299	215	70	5		
		7.5	125	372	242	114	95	221	149	337	197	80	290	44	178	5	349	311	265	64	5	
		7.5	145	372	242	133	95	260	187	461	197	80	290	44	178	5	349	311	265	44	5	
	2	149	372	242	133	95	260	187	461	197	80	290	44	178	5	349	311	265	44	5		
		15	155	372	265	114	108	221	149	337	197	80	290	44	178	5	423	385	291	64	5	
		15	163	372	265	133	108	260	187	461	197	80	290	44	178	5	423	385	291	44	5	
	4	15	177	372	265	133	108	260	187	461	197	80	290	44	178	5	423	385	291	44	5	
		1	127	339	198	89	70	175	133	311	197	80	265	25	159	13	338	299	215	70	5	
		1	141	339	198	89	70	175	133	311	197	80	265	25	159	13	338	299	215	70	5	
	015-070	2	1	155	339	198	89	70	175	133	311	197	80	265	25	159	13	338	299	215	70	5
			1.5	177	339	198	89	70	175	133	311	197	80	265	25	159	13	338	299	215	70	5
			5	114	372	242	114	95	221	149	337	197	80	290	44	178	5	349	311	265	64	5
2		7.5	128	372	242	114	95	221	149	337	197	80	290	44	178	5	349	311	265	64	5	
		10	142	372	265	133	108	260	187	461	197	80	290	44	178	5	423	385	291	44	5	
		15	160	372	265	133	108	260	187	461	197	80	290	44	178	5	423	385	291	44	5	
4		20	176	372	260	159	127	327	245	508	197	80	290	44	178	5	514	476	304	19	10	
		1	118	339	198	89	70	175	133	311	197	80	265	25	159	13	338	299	215	70	5	
		1	130	339	198	89	70	175	133	311	197	80	265	25	159	13	338	299	215	70	5	
015-090		2	1.5	150	339	198	89	70	175	133	311	197	80	265	25	159	13	338	299	215	70	5
			2	166	339	198	89	70	175	133	311	197	80	265	25	159	13	338	299	215	70	5
			3	176	372	242	114	95	221	149	337	197	80	290	44	178	5	349	311	265	64	5
	4	15	180	394	297	133	108	260	187	461	-	-	-	-	-	423	385	291	44	5		
		20	198	435	308	159	127	327	245	508	222	92	325	25	203	13	508	470	329	44	5	
		25	210	435	308	159	127	327	245	508	222	92	325	25	203	13	508	470	329	44	5	
	2	30	224	392	258	178	140	372	334	546	222	92	325	25	203	13	565	527	354	25	13	
		40	250	392	258	178	140	372	334	546	222	92	325	25	203	13	565	527	354	25	13	
		1.5	170	361	231	89	70	175	133	311	-	-	-	-	-	363	325	215	89	5		
	4	2	184	361	231	89	70	175	133	311	-	-	-	-	-	363	325	215	89	5		
		3	206	394	275	114	95	221	149	337	-	-	-	-	-	372	334	265	64	5		
		5	250	394	275	114	95	221	149	337	-	-	-	-	-	372	334	265	64	5		
015-095	2	15	164	394	297	133	108	260	187	461	-	-	-	-	-	423	385	291	44	5		
		20	178	435	308	159	127	327	245	508	222	92	325	25	203	13	508	470	329	44	5	
		25	190	435	308	159	127	327	245	508	222	92	325	25	203	13	508	470	329	44	5	
	4	30	200	392	258	178	140	372	334	546	222	92	325	25	203	13	565	527	354	25	13	
		40	224	392	258	178	140	372	334	546	222	92	325	25	203	13	565	527	354	25	13	
		50	246	415	289	203	159	419	359	584	229	95	350	51	229	5	597	559	392	25	13	
	2	2	166	361	231	89	70	175	133	311	-	-	-	-	-	363	325	215	89	5		
		3	186	394	275	114	95	221	149	337	-	-	-	-	-	372	334	265	64	5		
		5	224	394	275	114	95	221	149	337	-	-	-	-	-	372	334	265	64	5		
	4	7.5	250	394	297	133	108	260	187	461	-	-	-	-	-	423	385	291	44	5		

Dimensions for pumps with ODP motors and support rails [mm]

Pump size	Pole	P2 [hp]	Actual impeller size [mm]	ODP motor							Support rail under pump						Support rail under motor				
				LP	Q	D	E	T	AB	AG	L7	L8	B7	H5	H7	HG3	L4	L6	B4	H6	HG1
020-095	2	15	146	405	307	133	108	260	187	461	-	-	-	-	-	-	423	385	291	44	5
		20	160	446	318	159	127	327	245	508	222	92	325	25	203	13	508	470	329	44	5
		25	172	446	318	159	127	327	245	508	222	92	325	25	203	13	508	470	329	44	5
		30	182	403	269	178	140	372	334	546	222	92	325	25	203	13	565	527	354	25	13
	4	40	204	403	269	178	140	372	334	546	222	92	325	25	203	13	565	527	354	25	13
		50	218	426	300	203	159	419	359	584	229	95	350	51	229	5	597	559	392	25	13
		60	226 <sup>29)</sup>	426	300	203	159	419	359	584	229	95	350	51	229	5	597	559	392	25	13
		60	240 <sup>30)</sup>	426	300	203	159	419	359	584	229	95	350	51	229	5	597	559	392	25	13
020-110	4	2	148	361	231	89	70	175	133	311	-	-	-	-	-	-	363	325	215	89	5
		3	168	394	275	114	95	221	149	337	-	-	-	-	-	-	372	334	265	64	5
	5	5	206	394	275	114	95	221	149	337	-	-	-	-	-	-	372	334	265	64	5
		7.5	240	394	297	133	108	260	187	461	-	-	-	-	-	-	423	385	291	44	5
		5	206	394	275	114	95	221	149	337	-	-	-	-	-	-	372	334	265	64	5
020-135	4	7.5	228	394	297	133	108	260	187	461	-	-	-	-	-	-	423	385	291	44	5
		10	252	394	297	133	108	260	187	461	-	-	-	-	-	-	423	385	291	44	5
	5	15	262	394	292	159	127	327	245	508	-	-	-	-	-	-	514	476	304	19	10
		7.5	236	446	323	133	108	260	187	461	-	-	-	-	-	-	423	385	291	95	5
025-070	4	10	258	446	323	133	108	260	187	461	-	-	-	-	-	-	423	385	291	95	5
		15	290	446	338	159	127	327	245	508	-	-	-	-	-	-	521	483	329	70	5
	2	20	318	446	338	159	127	327	245	508	-	-	-	-	-	-	521	483	329	70	5
		25	340-336	481	383	178	140	372	334	549	-	-	-	-	-	-	552	514	385	51	8
		7.5	116	394	230	114	95	221	149	337	222	92	287	19	178	10	372	334	265	64	5
025-095	2	10	126	394	252	133	108	260	187	461	222	92	287	19	178	10	423	385	291	44	5
		15	144	394	252	133	108	260	187	461	222	92	287	19	178	10	423	385	291	44	5
		20	160	435	248	159	127	327	245	508	222	92	287	19	178	10	514	476	304	19	10
		25	168	435	248	159	127	327	245	508	222	92	287	19	178	10	514	476	304	19	10
	4	30	172	392	255	178	140	372	334	546	229	95	312	44	203	5	565	527	354	25	13
		1	118	361	231	89	70	175	133	311	-	-	-	-	-	-	338	299	215	70	5
		1.5	134	361	231	89	70	175	133	311	-	-	-	-	-	-	338	299	215	70	5
		2	148	361	231	89	70	175	133	311	-	-	-	-	-	-	338	299	215	70	5
025-095	4	3	168	394	230	114	95	221	149	337	222	92	287	19	178	10	372	334	265	64	5
		5	172	394	230	114	95	221	149	337	222	92	287	19	178	10	372	334	265	64	5
	2	25	152	446	352	159	127	327	245	508	-	-	-	-	-	-	508	470	329	44	5
		30	160	403	303	178	140	372	334	546	-	-	-	-	-	-	565	527	354	25	13
		40	182	403	303	178	140	372	334	546	-	-	-	-	-	-	565	527	354	25	13
		50	198	426	281	203	159	419	359	584	267	114	380	25	229	13	597	559	392	25	13
		60	214	426	281	203	159	419	359	584	267	114	380	25	229	13	597	559	392	25	13
		75	238 <sup>29)</sup>	426	293	229	178	470	459	635	267	114	405	51	254	5	622	584	431	25	13
	6	75	242 <sup>30)</sup>	426	293	229	178	470	459	635	267	114	405	51	254	5	622	584	431	25	13
		3	152	394	264	114	95	221	149	337	-	-	-	-	-	-	372	334	265	89	5
5		182	394	264	114	95	221	149	337	-	-	-	-	-	-	372	334	265	89	5	
7.5		214	394	287	133	108	260	187	461	-	-	-	-	-	-	423	385	291	70	5	
6	10	242	394	287	133	108	260	187	461	-	-	-	-	-	-	423	385	291	70	5	
	1	154	361	220	89	70	175	133	311	-	-	-	-	-	-	368	330	215	114	5	
	1.5	182	394	264	114	95	221	149	337	-	-	-	-	-	-	372	334	265	89	5	
	2	208	394	264	114	95	221	149	337	-	-	-	-	-	-	372	334	265	89	5	
6	3	242	394	287	133	108	260	187	461	-	-	-	-	-	-	423	385	291	70	5	

Dimensional drawings and technical data

Dimensions for pumps with ODP motors and support rails [mm]																					
Pump size	Pole	P2 [hp]	Actual impeller size [mm]	ODP motor							Support rail under pump						Support rail under motor				
				LP	Q	D	E	T	AB	AG	L7	L8	B7	H5	H7	HG3	L4	L6	B4	H6	HG1
025-110	4	7.5	218	446	311	133	108	260	187	461	-	-	-	-	-	-	423	385	291	70	5
		10	240	446	311	133	108	260	187	461	-	-	-	-	-	-	423	385	291	70	5
		15	280	446	325	159	127	327	245	508	-	-	-	-	-	-	508	470	329	44	5
	6	2	214	446	289	114	95	221	149	337	-	-	-	-	-	-	372	334	265	89	5
		3	244	446	311	133	108	260	187	461	-	-	-	-	-	-	423	385	291	70	5
030-070	2	5	280	446	311	133	108	260	187	461	-	-	-	-	-	-	423	385	291	70	5
		15	128	394	252	133	108	260	187	461	222	92	287	19	178	10	423	385	291	44	5
		20	142	435	248	159	127	327	245	508	222	92	287	19	178	10	514	476	304	19	10
		25	148	435	248	159	127	327	245	508	222	92	287	19	178	10	514	476	304	19	10
		30	160	392	255	178	140	372	334	546	229	95	312	44	203	5	565	527	354	25	13
	4	40	174	392	255	178	140	372	334	546	229	95	312	44	203	5	565	527	354	25	13
		1.5	120	361	231	89	70	175	133	311	-	-	-	-	-	-	338	299	215	70	5
		2	132	361	231	89	70	175	133	311	-	-	-	-	-	-	338	299	215	70	5
		3	148	394	230	114	95	221	149	337	222	92	287	19	178	10	372	334	265	64	5
		5	174	394	230	114	95	221	149	337	222	92	287	19	178	10	372	334	265	64	5
030-095	2	40	155	448	321	178	140	372	334	546	-	-	-	-	-	-	565	527	354	25	13
		50	165	471	300	203	159	419	359	584	267	114	415	25	229	13	597	559	392	25	13
		60	175	471	300	203	159	419	359	584	267	114	415	25	229	13	597	559	392	25	13
		75	187	471	313	229	178	470	459	635	267	114	440	51	254	5	622	584	431	25	13
		100	205	471	313	229	178	470	459	635	267	114	440	51	254	5	622	584	431	25	13
		125	225	471	339	254	203	541	490	705	254	108	440	76	279	5	699	660	506	25	13
		5	155	439	282	114	95	221	149	337	-	-	-	-	-	-	372	334	265	89	5
4	7.5	171	439	304	133	108	260	187	461	-	-	-	-	-	-	423	385	291	70	5	
	10	191	439	304	133	108	260	187	461	-	-	-	-	-	-	423	385	291	70	5	
	15	225	439	319	159	127	327	245	508	-	-	-	-	-	-	508	470	329	44	5	
	1.5	153	439	282	114	95	221	149	337	-	-	-	-	-	-	372	334	265	89	5	
	2	167	439	282	114	95	221	149	337	-	-	-	-	-	-	372	334	265	89	5	
6	3	191	439	304	133	108	260	187	461	-	-	-	-	-	-	423	385	291	70	5	
	5	225	439	304	133	108	260	187	461	-	-	-	-	-	-	423	385	291	70	5	
	10	216-208	446	311	133	108	260	187	461	-	-	-	-	-	-	423	385	291	70	5	
	15	248-240	446	325	159	127	327	245	508	-	-	-	-	-	-	508	470	329	44	5	
	20	278-270	446	325	159	127	327	245	508	-	-	-	-	-	-	508	470	329	44	5	
030-135	4	3	218-210	446	311	133	108	260	187	461	-	-	-	-	-	-	423	385	291	70	5
		5	266-258	446	311	133	108	260	187	461	-	-	-	-	-	-	423	385	291	70	5
		7.5	278-270	446	325	159	127	327	245	508	-	-	-	-	-	-	508	470	329	44	5
		15	228	446	325	159	127	327	245	508	-	-	-	-	-	-	533	495	329	95	5
		20	252	446	325	159	127	327	245	508	-	-	-	-	-	-	533	495	329	95	5
	6	25	270	481	370	178	140	372	334	549	-	-	-	-	-	-	565	527	385	76	8
		30	286	481	370	178	140	372	334	549	-	-	-	-	-	-	565	527	385	76	8
		40	328	505	405	203	159	419	359	603	-	-	-	-	-	-	591	552	423	51	8
		5	228	446	311	133	108	260	187	461	-	-	-	-	-	-	445	406	291	121	5
		7.5	268	446	325	159	127	327	245	508	-	-	-	-	-	-	533	495	329	95	5
040-070	2	10	298	446	325	159	127	327	245	508	-	-	-	-	-	-	533	495	329	95	5
		15	328	481	370	178	140	372	334	549	-	-	-	-	-	-	565	527	385	76	8
		20	138-122	461	308	159	127	327	245	508	222	92	355	25	203	13	508	470	329	44	5
		25	140	461	308	159	127	327	245	508	222	92	355	25	203	13	508	470	329	44	5
		30	146	418	258	178	140	372	334	546	222	92	355	25	203	13	565	527	354	25	13
4	40	160	418	258	178	140	372	334	546	222	92	355	25	203	13	565	527	354	25	13	
	50	172	440	289	203	159	419	359	584	229	95	380	51	229	5	597	559	392	25	13	



Dimensions for pumps with ODP motors and support rails [mm]

Pump size	Pole	P2 [hp]	Actual impeller size [mm]	ODP motor						Support rail under pump						Support rail under motor					
				LP	Q	D	E	T	AB	AG	L7	L8	B7	H5	H7	HG3	L4	L6	B4	H6	HG1
4	2	130-110	387	231	89	70	175	133	311	-	-	-	-	-	-	363	325	215	89	5	
	3	138	420	275	114	95	221	149	337	-	-	-	-	-	-	372	334	265	64	5	
	5	160	420	275	114	95	221	149	337	-	-	-	-	-	-	372	334	265	64	5	
	7.5	174	420	297	133	108	260	187	461	-	-	-	-	-	-	423	385	291	44	5	
6	0.75	130-122	387	231	89	70	175	133	311	-	-	-	-	-	-	363	325	215	89	5	
	1	140	387	231	89	70	175	133	311	-	-	-	-	-	-	363	325	215	89	5	
	1.5	156	420	275	114	95	221	149	337	-	-	-	-	-	-	372	334	265	64	5	
2	2	174	420	275	114	95	221	149	337	-	-	-	-	-	-	372	334	265	64	5	
	60	164	484	355	203	159	419	359	584	-	-	-	-	-	-	597	559	392	25	13	
	75	176	484	313	229	178	470	459	635	267	114	415	25	254	13	622	584	431	25	13	
	100	196	484	313	229	178	470	459	635	267	114	415	25	254	13	622	584	431	25	13	
040-095	125	212	484	332	254	203	541	490	705	267	114	440	51	279	5	699	660	506	25	13	
	4	7.5	162	452	304	133	108	260	187	461	-	-	-	-	-	423	385	291	95	5	
	10	180	452	304	133	108	260	187	461	-	-	-	-	-	423	385	291	95	5		
	15	212	452	319	159	127	327	245	508	-	-	-	-	-	521	483	329	70	5		
6	20	238	452	319	159	127	327	245	508	-	-	-	-	-	521	483	329	70	5		
	2	160	452	282	114	95	221	149	337	-	-	-	-	-	387	349	265	114	5		
	3	180	452	304	133	108	260	187	461	-	-	-	-	-	423	385	291	95	5		
	5	228	452	304	133	108	260	187	461	-	-	-	-	-	423	385	291	95	5		
040-110	7.5	238	452	319	159	127	327	245	508	-	-	-	-	-	521	483	329	70	5		
	4	15	206	459	325	159	127	327	245	508	-	-	-	-	521	483	329	70	5		
	20	222	459	325	159	127	327	245	508	-	-	-	-	-	521	483	329	70	5		
	25	240	494	370	178	140	372	334	549	-	-	-	-	-	552	514	385	51	8		
6	30	256	494	370	178	140	372	334	549	-	-	-	-	-	552	514	385	51	8		
	3	182	459	311	133	108	260	187	461	-	-	-	-	-	423	385	291	95	5		
	5	212	459	311	133	108	260	187	461	-	-	-	-	-	423	385	291	95	5		
	7.5	238	459	325	159	127	327	245	508	-	-	-	-	-	521	483	329	70	5		
040-135	10	256	459	325	159	127	327	245	508	-	-	-	-	-	521	483	329	70	5		
	4	20	236	459	327	159	127	327	245	508	-	-	-	-	533	495	329	95	5		
	25	260	494	372	178	140	372	334	549	-	-	-	-	-	565	527	385	76	8		
	30	278	494	372	178	140	372	334	549	-	-	-	-	-	565	527	385	76	8		
6	40	300	518	407	203	159	419	359	603	-	-	-	-	-	591	552	423	51	8		
	50	326	518	407	203	159	419	359	603	-	-	-	-	-	591	552	423	51	8		
	5	222	459	313	133	108	260	187	461	-	-	-	-	-	445	406	291	121	5		
	7.5	258	459	327	159	127	327	245	508	-	-	-	-	-	533	495	329	95	5		
040-150	10	284	459	327	159	127	327	245	508	-	-	-	-	-	533	495	329	95	5		
	15	320	494	372	178	140	372	334	549	-	-	-	-	-	565	527	385	76	8		
	4	50	310	547	419	203	159	419	359	603	-	-	-	-	616	578	423	76	8		
	60	328	547	435	229	178	470	459	632	-	-	-	-	-	622	584	462	51	8		
6	75	352	547	435	229	178	470	459	632	-	-	-	-	-	622	584	462	51	8		
	100	386	585	473	254	203	541	490	781	-	-	-	-	-	699	660	506	25	13		
	125	408	585	473	254	203	541	490	781	-	-	-	-	-	699	660	506	25	13		
	150	426	636	463	279	229	616	576	803	292	127	500	25	305	13	749	711	557	25	13	
6	15	304	530	391	178	140	372	334	549	-	-	-	-	-	578	540	385	102	8		
	20	340	530	391	178	140	372	334	549	-	-	-	-	-	578	540	385	102	8		
	25	368	547	419	203	159	419	359	603	-	-	-	-	-	616	578	423	76	8		
	30	388	547	419	203	159	419	359	603	-	-	-	-	-	616	578	423	76	8		
40	426	547	435	229	178	470	459	632	-	-	-	-	-	622	584	462	51	8			

Dimensional drawings and technical data

Dimensions for pumps with ODP motors and support rails [mm]																					
Pump size	Pole	P2 [hp]	Actual impeller size [mm]	ODP motor						Support rail under pump						Support rail under motor					
				LP	Q	D	E	T	AB	AG	L7	L8	B7	H5	H7	HG3	L4	L6	B4	H6	HG1
050-070	2	25	142-114	461	340	159	127	327	245	508	-	-	-	-	-	-	508	470	329	44	5
		30	152-124	418	291	178	140	372	334	546	-	-	-	-	-	-	565	527	354	25	13
		40	154	418	291	178	140	372	334	546	-	-	-	-	-	-	565	527	354	25	13
		50	164	440	270	203	159	419	359	584	267	114	380	25	229	13	597	559	392	25	13
		60	172	440	270	203	159	419	359	584	267	114	380	25	229	13	597	559	392	25	13
		75	176	440	283	229	178	470	459	635	267	114	405	51	254	5	622	584	431	25	13
050-070	4	3	138-110	420	262	114	95	221	149	337	-	-	-	-	-	-	372	334	265	89	5
		5	154	420	262	114	95	221	149	337	-	-	-	-	-	-	372	334	265	89	5
		7.5	168	420	284	133	108	260	187	461	-	-	-	-	-	-	423	385	291	70	5
		10	176	420	284	133	108	260	187	461	-	-	-	-	-	-	423	385	291	70	5
050-095	6	0.75	134-106	387	218	89	70	175	133	311	-	-	-	-	-	-	368	330	215	114	5
		1	150-106	387	218	89	70	175	133	311	-	-	-	-	-	-	368	330	215	114	5
		1.5	154	420	262	114	95	221	149	337	-	-	-	-	-	-	372	334	265	89	5
		2	168	420	262	114	95	221	149	337	-	-	-	-	-	-	372	334	265	89	5
		3	176	420	284	133	108	260	187	461	-	-	-	-	-	-	423	385	291	70	5
		10	174-154	504	356	133	108	260	187	461	-	-	-	-	-	-	445	406	291	121	5
050-095	4	15	188	504	370	159	127	327	245	508	-	-	-	-	-	-	533	495	329	95	5
		20	208	504	370	159	127	327	245	508	-	-	-	-	-	-	533	495	329	95	5
		25	222	517	393	178	140	372	334	549	-	-	-	-	-	-	565	527	385	76	8
		30	232	517	393	178	140	372	334	549	-	-	-	-	-	-	565	527	385	76	8
		3	174-154	504	356	133	108	260	187	461	-	-	-	-	-	-	445	406	291	76	5
		5	196	504	356	133	108	260	187	461	-	-	-	-	-	-	445	406	291	121	5
050-110	6	7.5	222	504	370	159	127	327	245	508	-	-	-	-	-	-	533	495	329	95	5
		10	232	504	370	159	127	327	245	508	-	-	-	-	-	-	533	495	329	95	5
		20	212	459	325	159	127	327	245	508	-	-	-	-	-	-	533	495	329	95	5
		25	230	494	370	178	140	372	334	549	-	-	-	-	-	-	565	527	385	76	8
		30	244	494	370	178	140	372	334	549	-	-	-	-	-	-	565	527	385	76	8
		40	270	518	405	203	159	419	359	603	-	-	-	-	-	-	591	552	423	51	8
050-110	4	5	206	459	311	133	108	260	187	461	-	-	-	-	-	-	445	406	291	121	5
		7.5	226	459	325	159	127	327	245	508	-	-	-	-	-	-	533	495	329	95	5
		10	254	459	325	159	127	327	245	508	-	-	-	-	-	-	533	495	329	95	5
		15	270	494	370	178	140	372	334	549	-	-	-	-	-	-	565	527	385	76	8
		25	225	530	391	178	140	372	334	549	-	-	-	-	-	-	578	540	385	102	8
		30	241	530	391	178	140	372	334	549	-	-	-	-	-	-	578	540	385	102	8
050-135	4	40	269	547	419	203	159	419	359	603	-	-	-	-	-	-	616	578	423	76	8
		50	287	547	419	203	159	419	359	603	-	-	-	-	-	-	616	578	423	76	8
		60	305	547	435	229	178	470	459	632	-	-	-	-	-	-	622	584	462	51	8
		75	333-329	547	435	229	178	470	459	632	-	-	-	-	-	-	622	584	462	51	8
		10	249	515	366	159	127	327	245	508	-	-	-	-	-	-	546	508	329	121	5
		15	287	530	391	178	140	372	334	549	-	-	-	-	-	-	578	540	385	102	8
050-150	6	20	317	530	391	178	140	372	334	549	-	-	-	-	-	-	578	540	385	102	8
		75	298	547	436	229	178	470	459	632	-	-	-	-	-	-	641	603	462	89	8
		100	330	585	485	254	203	541	490	781	-	-	-	-	-	-	686	648	545	64	12
		125	358	585	485	254	203	541	490	781	-	-	-	-	-	-	686	648	545	64	12
		150	380	636	512	279	229	616	576	803	-	-	-	-	-	-	940	902	588	38	8

Dimensions for pumps with ODP motors and support rails [mm]																				
Pump size	Pole	P2 [hp]	Actual impeller size [mm]	ODP motor						Support rail under pump						Support rail under motor				
				LP	Q	D	E	T	AB	AG	L7	L8	B7	H5	H7	HG3	L4	L6	B4	H6
6	25	312	547	420	203	159	419	359	603	-	-	-	-	-	-	603	565	423	114	8
	30	334	547	420	203	159	419	359	603	-	-	-	-	-	-	603	565	423	114	8
	40	368	547	436	229	178	470	459	632	-	-	-	-	-	-	641	603	462	89	8
	50	396	547	436	229	178	470	459	632	-	-	-	-	-	-	641	603	462	89	8
	60	410	585	485	254	203	541	490	781	-	-	-	-	-	-	686	648	545	64	12
	4	15	186	523	355	159	127	327	245	508	-	-	-	-	-	-	546	508	329	121
20		202	523	355	159	127	327	245	508	-	-	-	-	-	-	546	508	329	121	5
25		214	536	378	178	140	372	334	549	-	-	-	-	-	-	578	540	385	102	8
30		226	536	378	178	140	372	334	549	-	-	-	-	-	-	578	540	385	102	8
40		242	552	405	203	159	419	359	603	-	-	-	-	-	-	616	578	423	76	8
5		192	523	341	133	108	260	187	461	-	-	-	-	-	-	445	406	291	146	5
6	7.5	212	523	355	159	127	327	245	508	-	-	-	-	-	-	546	508	329	121	5
	10	234	523	355	159	127	327	245	508	-	-	-	-	-	-	546	508	329	121	5
	15	242	536	378	178	140	372	334	549	-	-	-	-	-	-	578	540	385	102	8
	30	223	549	391	178	140	372	334	549	-	-	-	-	-	-	578	540	385	102	8
	40	243	566	419	203	159	419	359	603	-	-	-	-	-	-	616	578	423	76	8
	50	259	566	419	203	159	419	359	603	-	-	-	-	-	-	616	578	423	76	8
4	60	273	566	435	229	178	470	459	632	-	-	-	-	-	-	622	584	462	51	8
	7.5	213	534	366	159	127	327	245	508	-	-	-	-	-	-	546	508	329	121	5
	10	233	534	366	159	127	327	245	508	-	-	-	-	-	-	546	508	329	121	5
	15	259	549	391	178	140	372	334	549	-	-	-	-	-	-	578	540	385	102	8
	20	273	549	391	178	140	372	334	549	-	-	-	-	-	-	578	540	385	102	8
	40	235	566	419	203	159	419	359	603	-	-	-	-	-	-	616	578	423	76	8
4	50	253	566	419	203	159	419	359	603	-	-	-	-	-	-	616	578	423	76	8
	60	263	566	435	229	178	470	459	632	-	-	-	-	-	-	622	584	462	51	8
	75	285	566	435	229	178	470	459	632	-	-	-	-	-	-	622	584	462	51	8
	100	311	604	473	254	203	541	490	781	-	-	-	-	-	-	699	660	506	25	13
	125	328-324	604	473	254	203	541	490	781	-	-	-	-	-	-	699	660	506	25	13
	10	221	534	366	159	127	327	245	508	-	-	-	-	-	-	546	508	329	121	5
6	15	249	549	391	178	140	372	334	549	-	-	-	-	-	-	578	540	385	102	8
	20	273	549	391	178	140	372	334	549	-	-	-	-	-	-	578	540	385	102	8
	25	293	566	419	203	159	419	359	603	-	-	-	-	-	-	616	578	423	76	8
	30	317-313	566	419	203	159	419	359	603	-	-	-	-	-	-	616	578	423	76	8
	125	304	626	507	254	203	541	490	781	-	-	-	-	-	-	686	648	545	64	12
	150	326	651	508	279	229	616	576	803	-	-	-	-	-	-	940	902	588	38	8
4	200	376	651	508	279	229	616	576	803	-	-	-	-	-	-	940	902	588	38	8
	250	402	651	508	279	229	616	576	1010	-	-	-	-	-	-	940	902	588	38	8
	40	316	626	497	229	178	470	459	632	-	-	-	-	-	-	641	603	462	89	8
	50	348	626	497	229	178	470	459	632	-	-	-	-	-	-	641	603	462	89	8
	60	378	626	507	254	203	541	490	781	-	-	-	-	-	-	686	648	545	64	12
	75	408	626	507	254	203	541	490	781	-	-	-	-	-	-	686	648	545	64	12
6	100	430	651	508	279	229	616	576	803	-	-	-	-	-	-	940	902	588	38	8
	60	250	566	435	229	178	470	459	632	-	-	-	-	-	-	622	584	462	121	8
	75	262	566	435	229	178	470	459	632	-	-	-	-	-	-	622	584	462	121	8
	100	286	604	489	254	203	541	490	781	-	-	-	-	-	-	667	629	512	95	8
	125	302	604	489	254	203	541	490	781	-	-	-	-	-	-	667	629	512	95	8
	150	320	655	508	279	229	616	576	803	-	-	-	-	-	-	806	768	596	70	12

		Dimensions for pumps with ODP motors and support rails [mm]																		
Pump size	Pole	P2 [hp]	Actual impeller size [mm]	ODP motor						Support rail under pump						Support rail under motor				
				LP	Q	D	E	T	AB	AG	L7	L8	B7	H5	H7	HG3	L4	L6	B4	H6
6	15	236	549	391	178	140	372	334	549	-	-	-	-	-	-	578	540	385	171	8
	20	258	549	391	178	140	372	334	549	-	-	-	-	-	-	578	540	385	171	8
	25	274	566	419	203	159	419	359	603	-	-	-	-	-	-	616	578	423	146	8
	30	286	566	419	203	159	419	359	603	-	-	-	-	-	-	616	578	423	146	8
	40	312	566	435	229	178	470	459	632	-	-	-	-	-	-	622	584	462	121	8
	50	334	566	435	229	178	470	459	632	-	-	-	-	-	-	622	584	462	121	8
4	125	310	651	507	254	203	541	490	781	-	-	-	-	-	-	699	660	545	146	12
	150	330	676	504	279	229	616	576	803	-	-	-	-	-	-	959	921	596	121	12
	200	362	676	504	279	229	616	576	803	-	-	-	-	-	-	959	921	596	121	12
	250	396	676	504	279	229	616	576	1010	-	-	-	-	-	-	959	921	596	121	12
	40	320	651	491	229	178	470	459	632	-	-	-	-	-	-	654	616	470	171	12
	50	342	651	491	229	178	470	459	632	-	-	-	-	-	-	654	616	470	171	12
6	60	362	651	507	254	203	541	490	781	-	-	-	-	-	-	699	660	545	146	12
	75	396	651	507	254	203	541	490	781	-	-	-	-	-	-	699	660	545	146	12
	150	317	676	513	279	229	616	576	803	-	-	-	-	-	-	953	914	596	121	12
4	200	347	666	513	279	229	616	576	803	-	-	-	-	-	-	953	914	596	171	12
	250	375	666	513	279	229	616	576	803	-	-	-	-	-	-	953	914	596	171	12
	50	329	666	504	279	178	616	576	1010	-	-	-	-	-	-	648	610	462	171	12
	60	351	641	516	229	203	470	459	632	-	-	-	-	-	-	699	660	545	222	8
	75	379	641	516	254	203	541	490	781	-	-	-	-	-	-	699	660	545	197	12
6	100	415	641	513	254	229	541	490	781	-	-	-	-	-	-	953	914	596	197	12

## Dimension for service

Pump size	X [inch]	X [mm]
012-070	5	127
015-070	5	127
015-090	5	127
015-095	5	127
020-095	5	127
020-110	5	127
020-135	6	152.4
025-070	5	127
025-095	5	127
025-110	5	127
030-070	5	127
030-095	6	152.4
030-110	5	127
030-135	6	152.4
040-070	5	127
040-095	6	152.4
040-110	6	152.4
040-135	6	152.4
040-150	9	228.6
050-070	5	127
050-095	6	152.4
050-110	6	152.4
050-135	7	177.8
050-150	9	228.6
060-095	6	152.4
060-110	7	177.8
060-135	9	228.6
060-150	9	228.6
080-135	9	228.6
080-150	9	228.6
100-150	9	228.6

## 17. Pump Energy Index (PEI)

Pump Energy Index (PEI) was established by the U.S. Department of Energy (DOE) and adopted by Canada as the standard metric used to evaluate pump efficiency. The value is the ratio of the pump efficiency rating (PER) divided by the calculated minimally complaint PER ( $PER_{STD}$ ) for the pump type. This provides a representation of a pump's actual performance compared to the minimal standard performance required by regulation. The lower the PEI value, the more efficient a pump is at the tested operating points.

PER is determined by defined testing parameters required by the DOE. This includes testing a particular pump model at its best efficiency point (BEP).

For PEI values there are two different versions:

- $PEI_{CL}$  (constant load): Applies to a bare-shaft pump, and a pump sold with a motor
- $PEI_{VL}$  (variable load): Applies to pumps sold with a motor and controller (such as VFD, VSD)

The DOE has set the maximum PEI value as 1.00. Any pump, pump and motor, or pump, motor and controller that exceeds a PEI value of 1.00 can no longer be manufactured after January 26, 2020.

PEI is a generalized efficiency value. PEI cannot be used to determine the efficiency of a pump in a specific application.

## NBSE pumps with speed-controlled motors

### Medium speed, 4000 RPM

Pump size	Impeller diameter [inch]	Power size [hp]	Voltage [V]	PEI value
012-070	4.69	3	3x200-240	0.43
	5.00	5		0.43
	5.47	7.5		0.43
	6.10	7.5		0.43
	6.97	10		0.50
	6.65	15		0.50
	6.97	15		0.50
	6.97	15		0.50
012-070	4.69	3	3x440-480	0.41
	5.00	5		0.41
	5.47	7.5		0.41
	6.10	7.5		0.41
	6.97	10		0.41
	6.65	15		0.41
	6.97	15		0.41
	6.97	15		0.41
015-070	4.49	5	3x200-240	0.47
	5.04	7.5		0.47
	6.73	10		0.50
	6.93	15		0.50
015-070	4.49	5	3x440-480	0.40
	5.04	7.5		0.40
	6.73	10		0.40
	6.93	15		0.40
	6.93	20		0.40
015-090	7.80	15	3x440-480	0.50
	8.82	20		0.50
	8.82	25		0.50
	9.84	30		0.50
015-095	7.01	15	3x440-480	0.50
	7.87	20		0.50
	7.87	25		0.50
	8.82	30		0.50
020-095	6.26	15	3x440-480	0.50
	7.17	20		0.50
	7.60	25		0.50
	8.03	30		0.50
025-070	4.57	5	3x200-240	0.48
	4.57	7.5		0.50
	4.96	10		0.50
	6.65	15		0.50
025-070	4.57	5	3x440-480	0.41
	4.57	7.5		0.41
	4.96	10		0.41
	6.65	15		0.41
	6.77	20		0.41
	6.77	25		0.41
	6.77	30		0.41
025-095	6.57	25	3x440-480	0.50
	7.17	30		0.50

Pump size	Impeller diameter [inch]	Power size [hp]	Voltage [V]	PEI value
030-070	5.04	7.5	3x200-240	0.50
	5.39	10		0.50
	5.87	15		0.50
030-070	5.04	7.5	3x440-480	0.50
	5.39	10		0.50
	5.87	15		0.50
	6.02	20		0.50
	6.85	25		0.50
	6.85	30		0.50
	6.85	30		0.50
040-070	5.12	15	3x440-480	0.50
	5.51	20		0.50
	5.51	25		0.50
040-070	5.75	30	3x440-480	0.50
	5.75	30		0.50
	5.75	30		0.50
050-070	5.04	15	3x440-480	0.50
	5.04	20		0.50
	5.04	25		0.50
	5.04	25		0.50
	5.43	30		0.50

## Low speed, 2200 RPM

Pump size	Impeller diameter [inch]	Power size [hp]	Voltage [V]	PEI value
012-070	6.97	1.5	3x440-480	0.39
	6.97	2		0.39
015-070	6.54	1.5	3x440-480	0.43
	6.93	2		0.43
	6.93	3		0.43
	6.93	5		0.43
015-090	7.24	1.5	3x440-480	0.39
	8.11	2		0.39
	9.84	3		0.39
	9.84	5		0.39
	9.84	7.5		0.39
	9.84	10		0.39
015-095	7.32	2	3x440-480	0.41
	8.35	3		0.41
	8.82	5		0.41
	9.84	7.5		0.41
	9.84	10		0.41
020-095	5.83	2	3x440-480	0.43
	7.24	3		0.43
	9.45	5		0.43
	9.45	7.5		0.43
	9.45	10		0.43
020-110	8.98	5	3x440-480	0.41
	9.92	7.5		0.41
	9.92	10		0.41
	10.31	15		0.41
	9.92	20		0.41
020-135	10.16	7.5	3x440-480	0.41
	11.42	10		0.41
	12.52	15		0.41
	13.31	20		0.41
	13.31	25		0.41
025-070	13.31	30	3x440-480	0.41
	5.28	1.5		0.41
	6.54	2		0.41
	6.61	3		0.41
025-095	6.77	5	3x440-480	0.41
	5.98	3		0.42
	9.13	5		0.42
	9.53	7.5		0.42
025-110	9.53	10	3x440-480	0.42
	9.45	7.5		0.41
	10.63	10		0.41
	11.02	15		0.41
030-070	11.02	20	3x440-480	0.41
	5.20	1.5		0.42
	5.71	2		0.42
	6.85	3	3x440-480	0.42
	6.85	5		0.42

Pump size	Impeller diameter [inch]	Power size [hp]	Voltage [V]	PEI value
030-095	6.10	5	3x440-480	0.43
	8.27	7.5		0.43
	8.86	10		0.43
	8.86	15		0.43
030-110	8.86	20	3x440-480	0.43
	9.61	10		0.41
	10.79	15		0.41
	10.79	20		0.41
030-135	9.92	15	3x440-480	0.50
	11.26	20		0.50
	11.77	25		0.50
	12.91	30		0.50
040-070	4.72	1.5	3x440-480	0.43
	4.96	2		0.43
	5.43	3		0.43
	6.30	5		0.43
	6.85	7.5		0.43
040-095	6.85	10	3x440-480	0.43
	7.13	7.5		0.43
	8.35	10		0.43
	8.35	15		0.43
	9.37	20		0.43
040-110	8.74	15	3x440-480	0.43
	10.08	20		0.43
	10.08	25		0.43
	10.08	30		0.43
040-135	9.29	15	3x440-480	0.50
	10.24	20		0.50
	10.98	25		0.50
	11.42	30		0.50
	5.43	3		3x440-480
050-070	6.85	5	0.43	
	6.93	7.5	0.43	
	6.93	10	0.43	
050-095	7.68	10	3x440-480	
	8.19	15		0.43
	8.58	20		0.43
	9.13	25		0.43
050-110	9.13	30	3x440-480	0.43
	8.35	15		0.50
	9.13	20		0.50
	9.13	25		0.50
	9.61	30		0.50
060-095	7.32	15	3x440-480	0.50
	7.95	20		0.50
	8.43	25		0.50
	8.90	30		0.50
060-110	8.78	25	3x440-480	0.50
	8.78	30		0.50



## NBS pumps with fixed-speed motors

### 2-pole

Pump size	Max. Power [hp]	Max. impeller trim [inch]	PEI		
			Bare pump	Pump with motor	Pump with motor and CUE
012-070	15	6.97	0.93	0.93	0.48
015-070	20	6.93	0.91	0.91	0.46
015-090	40	9.84	0.88	0.88	0.44
015-095	50	9.69	0.88	0.88	0.44
020-095	60	9.45	0.9	0.9	0.44
025-070	30	6.77	0.91	0.91	0.47
025-095	75	9.53	0.93	0.93	0.45
030-070	40	6.85	0.93	0.93	0.47
030-095	125	8.86	0.94	0.94	0.46
040-070	50	6.77	0.93	0.94	0.46
040-095	125	8.35	0.96	0.96	0.47
050-070	75	6.93	0.94	0.94	0.46

### 4-pole

Pump size	Max. Power [hp]	Max. impeller trim [inch]	PEI		
			Bare pump	Pump with motor	Pump with motor and CUE
012-070	1.5	6.97	0.87	0.87	0.47
015-070	3	6.93	0.92	0.92	0.49
015-090	5	9.84	0.84	0.84	0.44
015-095	7.5	9.84	0.9	0.9	0.45
020-095	7.5	9.45	0.94	0.94	0.47
020-110	15	10.31	0.89	0.89	0.45
020-135	25	13.39-13.23	0.87	0.87	0.43
025-070	5	6.77	0.89	0.89	0.48
025-095	10	9.53	0.91	0.91	0.45
025-110	15	11.02	0.9	0.9	0.45
030-070	5	6.85	0.9	0.9	0.47
030-095	15	8.86	0.92	0.92	0.46
030-110	20	10.94-10.63	0.9	0.9	0.45
030-135	40	12.91	0.91	0.92	0.45
040-070	7.5	6.85	0.93	0.93	0.47
040-095	20	9.37	0.95	0.95	0.46
040-110	30	10.08	0.93	0.93	0.46
040-135	50	12.83	0.95	0.95	0.46
040-150	150	16.77	0.97	0.97	0.47
050-070	10	6.93	0.94	0.94	0.47
050-095	30	9.13	0.93	0.93	0.46
050-110	40	10.63	0.95	0.95	0.47
050-135	75	13.11-12.95	0.94	0.94	0.45
050-150	150	14.96	0.95	0.95	0.46
060-095	40	9.53	0.93	0.93	0.45
060-110	60	10.75	0.93	0.93	0.44
060-135	125	12.91-12.76	0.95	0.95	0.46
060-150	250	15.83	OUT OF SCOPE		
080-135	150	12.6	0.94	0.94	0.45
080-150	250	15.59	OUT OF SCOPE		
100-150	250	14.76	OUT OF SCOPE		

### 6-pole

6-pole pumps are out of DOE scope, PEI value is not available.

## 18. Motor data

### Standard motor range

The table shows the standard motors currently available for NBS pumps.

IE class	Motor enclosure	Pole	P2 [hp (kW)]																				
			1 (0.75)	1.5 (1.1)	2 (1.5)	3 (2.2)	5 (3.7)	7.5 (5.5)	10 (7.5)	15 (11)	20 (15)	25 (18.5)	30 (22)	40 (30)	50 (37)	60 (45)	75 (55)	100 (75)	125 (90)	150 (110)	200 (150)	250 (185)	
IE3	ODP <sup>31)</sup>	2	-	-	-	•	•	•	•	•	•	•	•	•	•	•	•	•	•	-	-	-	
		4	•	•	•	•	•	•	•	•	•	•	•	•	•	•	•	•	•	•	•	•	•
		6	•	•	•	•	•	•	•	•	•	•	•	•	•	•	•	•	•	-	-	-	-
IE3	TEFC <sup>32)</sup>	2	-	-	•	•	•	•	•	•	•	•	•	•	•	•	•	•	•	-	-	-	
		4	•	•	•	•	•	•	•	•	•	•	•	•	•	•	•	•	•	•	•	•	-
		6	•	•	•	•	•	•	•	•	•	•	•	•	•	•	•	•	•	-	-	-	-
IE5	TEFC <sup>32)</sup>	2	-	-	-	•	•	•	•	•	•	•	-	-	-	-	-	-	-	-	-	-	
		4	-	•	•	•	•	•	•	•	•	•	•	-	-	-	-	-	-	-	-	-	-

<sup>31)</sup> ODP: Open drip proof.

<sup>32)</sup> TEFC: Totally enclosed fan-cooled.

### MLE motor range

The table below shows the frequency controlled MLE motors used in the NBSE pump range.

	IE class	Motor enclosure	P2 [hp (kW)]											
			1.5 (1.1)	2 (1.5)	3 (2.2)	5 (3)	7.5 (5.5)	10 (7.5)	15 (11)	20 (15)	25 (18.5)	30 (22)		
Medium speed, 4000 RPM	IE5	TEFC	-	-	•	•	•	•	•	•	•	•	•	•
Low speed, 2000 / 2200 RPM	IE5	TEFC	•	•	•	•	•	•	•	•	•	•	•	

### Electrical data, MLE motors

For electrical data of MLE motors, see the "MLE" data booklet. The data sheet is available in Grundfos Product Center on [www.grundfos.com](http://www.grundfos.com). For further information on Grundfos Product Center, see section Grundfos Product Center.

#### Related information

[21. Grundfos Product Center](#)

## 19. Accessories

### Flow sensor

Grundfos vortex flow sensor, VFI <sup>33)</sup>	Type	Flow range gal/min (m <sup>3</sup> /h)	Pipe connection	O-ring		Connection type		Product number	
				EPDM	FKM	Cast iron flange	Stainless steel flange		
 <ul style="list-style-type: none"> <li>• Sensor tube with sensor</li> <li>• Sensor tube of 1.4408 and sensor of 1.4404</li> <li>• 2 flanges</li> <li>• 5 m cable with M12 connection in one end</li> <li>• Quick guide</li> </ul>	VFI 1.3-25 DN32 020 E	5.7 - 110.1 (1.3 - 25)	1 ¼" DN 32	•		•		97686141	
	VFI 1.3-25 DN32 020 F				•		•		97686142
	VFI 1.3-25 DN32 020 E				•			•	97688297
	VFI 1.3-25 DN32 020 F					•			•
	VFI 2-40 DN40 020 E	8.8 - 176.1 (2-40)	1 ½" DN 40	•		•		97686143	
	VFI 2-40 DN40 020 F				•		•	97686144	
	VFI 2-40 DN40 020 E				•			•	97688299
	VFI 2-40 DN40 020 F					•			•
	VFI 3.2-64 DN50 020 E	8.8 - 281.8 (2-64)	2" DN 50	•		•		97686145	
	VFI 3.2-64 DN50 020 F					•	•	97686146	
	VFI 3.2-64 DN50 020 E				•			•	97688301
	VFI 3.2-64 DN50 020 F					•			•
	VFI 5.2-104 DN65 020 E	22.9 - 457.9 (5.2 - 104)	2 ½" DN 65	•		•		97686147	
	VFI 5.2-104 DN65 020 F					•	•	97686148	
	VFI 5.2-104 DN65 020 E				•			•	97688303
	VFI 5.2-104 DN65 020 F					•			•
	VFI 8-160 DN80 020 E	35.2 - 704.5 (8-160)	3" DN 80	•		•		97686149	
	VFI 8-160 DN80 020 F					•	•	97686150	
	VFI 8-160 DN80 020 E				•			•	97688305
	VFI 8-160 DN80 020 F					•			•
VFI 12-240 DN100 020 E	52.8 - 1056.7 (12-240)	4" DN 100	•		•		97686151		
VFI 12-240 DN100 020 F					•	•	97686152		
VFI 12-240 DN100 020 E				•			•	97688308	
VFI 12-240 DN100 020 F					•			•	97688309

<sup>33)</sup> For more information about the VFI sensor, see the "Grundfos direct sensors" data booklet, publication number 97790189.

## Pressure sensors

Grundfos offers a wide range of custom-built RPS and DPS sensors.

The RPS and DPS sensors can be customised depending on the application.

Therefore, contact Grundfos Direct Sensors™ when proceeding to selection.

Grundfos differential pressure sensor standard, DPS	Data sheet product number <sup>34)</sup>	Pressure range [psi (bar)]
	97849781	0 - 8.7 (0 - 0.6)
	97849782	0 - 14.5 (0 - 1.0)
	97849783	0 - 23.2 (0 - 1.6)
	97849784	0 - 36.3 (0 - 2.5)
	97849785	0 - 58.0 (0 - 4.0)
	97849786	0 - 87.0 (0 - 6.0)

Relative Pressure sensor Standard, RPS	Data sheet product number <sup>34)</sup>	Pressure range [psi (bar)]
	97892947	0 - 8.7 (0 - 0.6)
	97892946	0 - 14.5 (0 - 1.0)
	97892947	0 - 23.2 (0 - 1.6)
	97892948	0 - 36.3 (0 - 2.5)
	97892946	0 - 58.0 (0 - 4.0)
	97892950	0 - 87.0 (0 - 6.0)
	97892961	0 - 145.0 (0-10)
		0 - 232.0 (0-16)

<sup>34)</sup> Enter the product number of the data sheet into Grundfos Product Center to view data for the sensor.

**Note:** Select the differential pressure sensor so that the maximum pressure of the sensor is higher than the maximum differential pressure of the pump.

## External Grundfos sensors

Sensor interface, SI 001 PSU <sup>35)</sup> Product number



Grundfos Direct Sensors™, type SI 001 PSU, is an external power supply for the VFI, RPS, DPS and other transmitters that require 24 VDC supply voltage.

It is used when the cable between transmitter and controller is more than 95.5 feet (30 meters) long.

96915820

<sup>35)</sup> For more information about the PSU sensor interface, see the Installation and operating instructions "SI 001 PSU - sensor interface", publication number 96944355, or Quick guide, publication number 96944356.

Danfoss pressure sensor kit	Pressure range PSI (bar)	Product number
<ul style="list-style-type: none"> <li>• Connection: G 1/2 A (DIN 16288 - B6kt)</li> <li>• Electrical connection: Plug (DIN 43650)</li> </ul>	0 - 36.3 (0 - 2.5)	96478188
	0-58 (0-4)	91072075
	0-87 (0-6)	91072076
	0-145 (0-10)	91072077
	0-232 (0-16)	91072078
<ul style="list-style-type: none"> <li>• Pressure sensor, type MBS 3000, with 2 m screened cable</li> <li>• Connection: G 1/4 A (DIN 16288 - B6kt)</li> <li>• 5 cable clips, black</li> <li>• Fitting instructions PT (00400212)</li> </ul>	0 - 36.3 (0 - 2.5)	405159
	0-58 (0-4)	405160
	0-87 (0-6)	405161
	0-145 (0-10)	405162
	0-232 (0-16)	405163

	Type	Supplier	Measuring range	Product number
Flowmeter	SITRANS F M MAGFLO MAG 5100 W	Siemens	4.4 - 22.0 gal/min (1") 1-5 m <sup>3</sup> /h (DN 25)	ID8285
Flowmeter	SITRANS F M MAGFLO MAG 5100 W	Siemens	13.2 - 44.0 gal/min (1 1/2") 3-10 m <sup>3</sup> /h (DN 40)	ID8286
Flowmeter	SITRANS F M MAGFLO MAG 5100 W	Siemens	26.4 - 132.1 gal/min (2 1/2") 6-30 m <sup>3</sup> /h (DN 65)	ID8287
Flowmeter	SITRANS F M MAGFLO MAG 5100 W	Siemens	88.1 - 330.2 gal/min (4") 20-75 m <sup>3</sup> /h (DN 100)	ID8288
Temperature sensor	TTA (0) 25	Carlo Gavazzi	32-77 °F 0-25 °C	96432591
Temperature sensor	TTA (-25) 25	Carlo Gavazzi	-13 to +77 °F -25 to +25 °C	96430194
Temperature sensor	TTA (50) 100	Carlo Gavazzi	122-212 °F 50-100 °C	96432592
Temperature sensor	TTA (0) 150	Carlo Gavazzi	32-302 °F 0-150 °C	96430195
Accessory for temperature sensor. All with 1/2 RG connection.	Protecting tube Ø9 x 50 mm	Carlo Gavazzi		96430201
	Protecting tube Ø9 x 100 mm	Carlo Gavazzi		96430202
	Cutting ring bush	Carlo Gavazzi		96430203
Temperature sensor, ambient temperature	WR 52	tmg (DK: Plesner)	-58 to + 122 °F -50 to +50 °C	ID8295
Differential temperature sensor	ETSD	Honsberg	32-68 °F 0-20 °C	96409362
Differential temperature sensor	ETSD	Honsberg	32-122 °F 0-50 °C	96409363

**Note:** All sensors have 4-20 mA output signal.

## Potentiometer

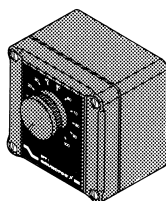

TM021630

Potentiometer for setpoint setting and start/stop of the pump.

Product	Product number
External potentiometer with cabinet for wall mounting	625468

## Grundfos GO

Grundfos GO is used for wireless infrared or radio communication with the pumps.

Grundfos GO is implemented in NBSE using Mobile interface MI-301 which is described below.

### MI 301

MI 301 is a module with built-in infrared and radio communication. Use MI 301 in conjunction with an Android or iOS-based smart devices with a Bluetooth connection. MI 301 has a rechargeable Li-ion battery and you must charge it separately.



TM053890

MI 301

Supplied with the product:

- Grundfos MI 301
- sleeve
- battery charger
- quick guide.

## Product numbers

Grundfos GO variant	Product number
Grundfos MI 301	98046408

## Supported units

Make	Model	Operating system	MI 301
Apple	iPod touch 4G	iOS 5.0 or later	•
	iPhone 4, 4S		•
	iPod touch 5G	iOS 6.0 or later	•
	iPhone 5		•
HTC	Desire S	Android 2.3.3 or later	•
	Sensation	Android 2.3.4 or later	•
Samsung	Galaxy S II		•
	Galaxy Nexus	Android 4.0 or later	•
LG	Google Nexus 4	Android 4.2 or later	•

**Note:** Similar Android and iOS-based devices may work as well, but are not supported by Grundfos.

## CIU communication interface units



GRA6118

Grundfos CIU communication interface unit

The CIU units enable communication of operating data, such as measured values and setpoints, between E-pumps and a building management system. The CIU unit incorporates a 24-240 VAC/VDC power supply module and a CIM module. It can either be mounted on a DIN rail or on a wall.

We offer the following CIU units:

Description	Fieldbus protocol	Product number
CIU 100	LonWorks for pumps	96753735
CIU 150	PROFIBUS DP	96753081
CIU 200	Modbus RTU	96753082
CIU 260 *	Cellular	
CIU 280*	GRM	
CIU 300	BACnet MS/TP	96893769
CIU 500	Ethernet, BACnet IP	
CIU 500	Ethernet, Modbus TCP	
CIU 500	Ethernet, PROFINET IO	96753894
CIU 500	Ethernet, GRM IP	
CIU 500	Ethernet, EtherNet/IP	
CIU 900	CIU box without CIM	99448387
CIU 901	CIU box with IO 270 only	99448389

\* Antenna not included. See section Antennas and battery.

For further information about data communication via CIU units and fieldbus protocols, see the CIU documentation available in Grundfos Product Center.

### Related information

[Antennas and battery](#)

## CIM communication interface modules

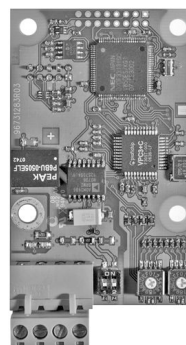

GRA6121

Grundfos CIM communication interface module

The CIM modules enable communication of operating data, such as measured values and setpoints, between E-pumps of 3-15 hp (2.2 - 11 kW) and a building management system. The CIM modules are add-on communication modules which are installed in the terminal box.

**Note:** CIM modules must be installed by authorized personnel.

We offer the following CIM modules:

Product	Description	Product number
CIM 100	LonWorks for pumps	96824797
CIM 110	LonWorks for multipump	96824798
CIM 150	PROFIBUS DP	96824793
CIM 200	Modbus RTU	96824796
CIM 260-EU*	3G/4G cellular	99439302
CIM 260-US*	3G/4G cellular	99439306
CIM 280 *	GRM	
CIM 280-EU*	GiC/GRM 3G/4G	99439724
CIM 280-US*	GiC/GRM 3G/4G	99439725
CIM 300	BACnet MS/TP	96893770
CIM 500	Ethernet, BACnet IP	
CIM 500	Ethernet, Modbus TCP	
CIM 500	Ethernet, PROFINET IO	98301408
CIM 500	Ethernet, GRM IP	
CIM 500	Ethernet, EtherNet/IP	

\* Antenna not included. See section Antennas and battery.

For further information about data communication via CIM modules and fieldbus protocols, see the CIM documentation available in Grundfos Product Center.

### Related information

[Antennas and battery](#)





## Shims

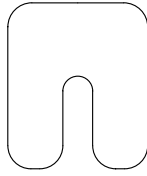

TM043264

### Shim

Shims to adjust motor height when aligning pump and motor.

Product	Product number
Small case (180 pcs)	96659156
Large case (360 pcs)	96659157

Each case contains three types of shims:

**Type 1:** 55 x 50 mm (2.17 x 1.97 in), 15 mm (0.59 in) slot.

**Type 2:** 75 x 70 mm (2.95 x 2.76 in), 23 mm (0.91 in) slot.

**Type 3:** 90 x 80 mm (3.54 x 3.15 in), 32 mm (1.26 in) slot.

Each type has ten of each of three sizes: 0.02; 0.028; 0.039 inch (0.5; 0.7; 1 mm).

A large case contains 20 of each of the above-mentioned shims. Refills can be found via service.

## 20. Service

Some pump parts will become worn over time and need to be replaced. These parts can be ordered as service kits.

### **Service recommendations**

To avoid unnecessary downtime, we recommend that you stock certain service parts. These service parts should be ordered together with the pump.

Information about service kits and recommended service parts can be found in the service kit catalogue.

In Grundfos Product Center, you can also search for the "Service offerings" data booklet, which gives relevant information about service issues.

## 21. Grundfos Product Center

Online search and sizing tool to help you make the right choice.

From the international view, you can select your specific country to view the product range available to you.

International view: <https://product-selection.grundfos.com>

### All the information you need in one place

Performance curves, technical specifications, pictures, dimensional drawings, motor curves, wiring diagrams, spare parts, service kits, 3D drawings, documents, system parts. The Product Center displays any recent and saved items - including complete projects - right on the main page.

### Downloads

On the product pages, you can download installation and operating instructions, data booklets, service instructions, etc., in PDF format.

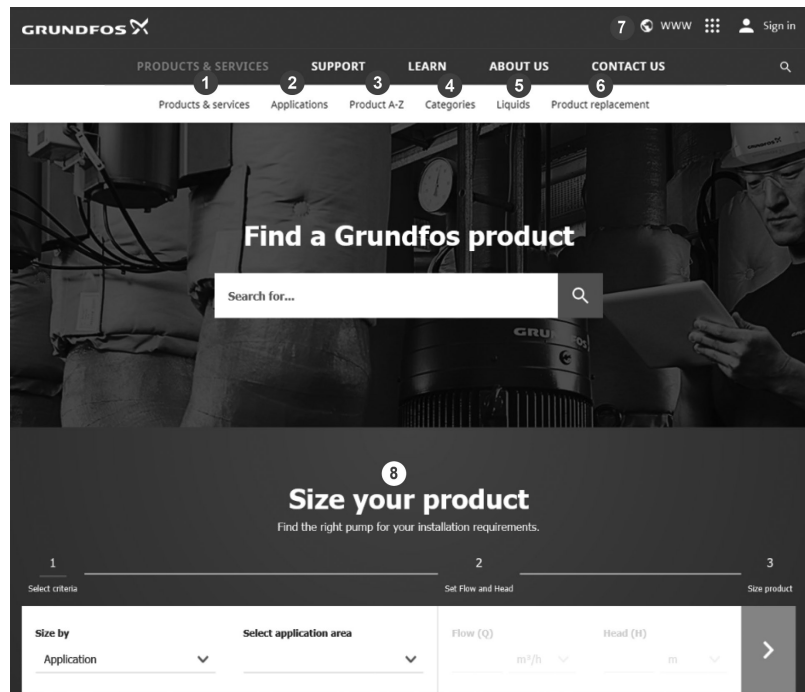

When you select your country, you will see the menus below. Note that some menus may not be available depending on the country.

Example: <https://product-selection.grundfos.com/uk>

Pos.	Description
1	<b>Products &amp; services</b> enables you to find products and documents by typing a product number or name into the search field.
2	<b>Applications</b> enables you to choose an application to see how Grundfos can help you design and optimize your system.
3	<b>Products A-Z</b> enables you to look through a list of all the Grundfos products.
4	<b>Categories</b> enables you to look for a product category.
5	<b>Liquids</b> enables you to find pumps designed for aggressive, flammable or other special liquids.
6	<b>Product replacement</b> enables you to find a suitable replacement.
7	<b>WWW</b> enables you to select the country, which changes the language, the available product range and the structure of the website.
8	<b>Sizing</b> enables you to size a product based on your application and operating conditions.

## 22. Grundfos GO

### Mobile solution for professionals on the GO!

Grundfos GO is the mobile tool box for professional users on the go. It is the most comprehensive platform for mobile pump control and pump selection, including

sizing, replacement and documentation. It offers intuitive, handheld assistance and access to Grundfos online tools, and it saves valuable time for reporting and data collection.

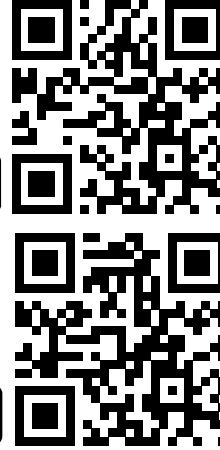

99932033 10.2024

ECM: 1406190

**GRUNDFOS Holding A/S**  
Poul Due Jensens Vej 7  
DK-8850 Bjerringbro  
Tel: +45 87 50 14 00  
[www.grundfos.com](http://www.grundfos.com)

**GRUNDFOS** 