

# Dell Unity™ All Flash and Unity Hybrid Hardware Information Guide

## Notes, cautions, and warnings

 **NOTE:** A NOTE indicates important information that helps you make better use of your product.

 **CAUTION:** A CAUTION indicates either potential damage to hardware or loss of data and tells you how to avoid the problem.

 **WARNING:** A WARNING indicates a potential for property damage, personal injury, or death.

<b>Additional resources.....</b>	<b>5</b>
About this guide.....	5
Related documentation.....	5
<b>Chapter 1: Platform Overview.....</b>	<b>6</b>
Overview.....	6
Description.....	6
<b>Chapter 2: Technical specifications.....</b>	<b>12</b>
Dimensions and weights.....	12
Power requirements.....	13
System operating limits.....	18
DPE airflow.....	19
Environmental recovery.....	19
Air quality requirements.....	19
Fire suppressant disclaimer.....	20
Shock and vibration.....	20
Shipping and storage requirements.....	20
<b>Chapter 3: Hardware component descriptions.....</b>	<b>22</b>
Disk processor enclosure.....	22
General disk processor enclosure information.....	22
2U, 12 (3.5-inch) disk drive DPE.....	24
2U, 25 (2.5-inch) disk drive DPE.....	25
2U DPE rear view.....	26
Storage processor rear view.....	27
About converged network adapter (CNA) ports.....	29
SP I/O module types.....	30
SP power supply module.....	39
Storage processor internal components.....	40
<b>Chapter 4: Disk-array enclosures.....</b>	<b>41</b>
General information on front-loading DAEs.....	41
Disk drive type .....	42
2U, 25 (2.5-inch) DAE.....	42
2U, 25-drive DAE front view.....	42
2U, 25 (2.5-inch) rear view.....	43
3U, 15 (3.5-inch) DAE.....	45
3U, 15-drive DAE Front view.....	46
3U, 15-drive DAE rear view.....	47
General information on drawer-type DAEs.....	49
3U, 80 (2.5-inch) DAE.....	50
3U, 80-drive DAE top view.....	51
3U, 80-drive DAE front view.....	52

3U, 80-drive DAE rear view.....	53
<b>Appendix A: Cabling.....</b>	<b>57</b>
Cable label wraps.....	57
Cabling the DPE to a DAE.....	57
Cabling the first optional DAE to create back-end bus 1.....	58
Cabling the second optional DAE to extend back-end bus 0.....	60
Cabling the DPE SAS module ports to create back-end buses 2 through 5.....	61
Cabling an expansion DAE to an existing DAE to extend a back-end bus.....	64
12Gb/s SAS cabling for interleaved DAE configurations.....	67
12Gb/s SAS cabling for stacked DAE configurations.....	69
Attaching expansion (back-end) cables to an 80-drive DAE.....	71
Cabling for x4 connections.....	71
Cabling for x8 connections.....	76
<b>Appendix B: Rail kits and cables.....</b>	<b>78</b>
Rail kits.....	78
Cable types.....	78
DAE-to-DAE copper cabling.....	80

As part of an improvement effort, revisions of the software and hardware are periodically released. Therefore, some functions described in this document might not be supported by all versions of the software or hardware currently in use. The product release notes provide the most up-to-date information on product features. Contact your technical support professional if a product does not function properly or does not function as described in this document.

## Where to get help

Support, product, and licensing information can be obtained as described below.

## Product information

For product and feature documentation or release notes, go to Unity Technical Documentation at: <https://www.dell.com/unitydocs>.

## Troubleshooting

For information about products, software updates, licensing, and service, go to Support (registration required) at: <https://www.dell.com/support>. After logging in, locate the appropriate product page.

## About this guide

This guide is designed for personnel who install, configure, and maintain the Unity 300/300F/350F/380/380F, Unity 400/400F/450F, Unity 500/500F/550F, and Unity 600/600F/650F platform. To use this hardware publication, you should be familiar with digital storage equipment and cabling.

 **NOTE:** This document was accurate at publication time. New versions of this document might be released. Check to ensure that you are using the latest version of this document.

## Related documentation

The following Unity system documents provide additional information.

- *Dell Unity™ Family Installation Guide*
- *Dell Unity™ Family Release Notes*

Additional relevant documentation can be obtained at:

- <https://www.dell.com/unitydocs>
- <https://www.dell.com/support>

# Platform Overview

This section provides an overview for the Unity 300/300F/350F/380/380F, Unity 400/400F/450F, Unity 500/500F/550F, and Unity 600/600F/650F platforms as well as an overview of their architecture, features, and components.

## Topics:

- [Overview](#)
- [Description](#)

## Overview

Unity Hybrid and All Flash storage systems implement an integrated architecture for block, file, and VMware VVols with concurrent support for native NAS, iSCSI, and Fibre Channel protocols based on the powerful new family of Intel E5-2600 processors. Each system leverages dual storage processors, full 12-Gb SAS back-end connectivity and patented multi-core architected operating environment to deliver unparalleled performance & efficiency. Additional storage capacity is added via Disk Array Enclosures (DAEs).

Unity is the only storage system that successfully meets all four storage requirements of today's IT professionals:

- Unity is Simple** Unity solutions set new standards for storage systems with compelling simplicity, modern design, affordable prices, and flexible deployments - to meet the needs of resource-constrained IT professionals in large or small companies.
- Unity is Modern** Unity has a modern 2U architecture designed for all-flash, designed to support the high density SSD's including 3D NAND TLC (triple level cell) drives. Unity includes automated data lifecycle management to lower costs, integrated copy data management to control local point-in-time snapshots, built-in encryption and remote replication, and deep ecosystem integration with VMware and Microsoft.
- Unity is Affordable** Our dual-active controller system was designed to optimize the performance, density, and cost of your storage to deliver all-flash or hybrid configurations for much less than you thought possible.
- Unity is Flexible** Unity is available as a virtual storage appliance, purpose-built all flash or hybrid configurations, or as converged systems - with one Unity operating environment that connects them all together.

## Description

This section shows examples of the front and rear views of Unity 300/300F/350F/380/380F, Unity 400/400F/450F, Unity 500/500F/550F, and Unity 600/600F/650F and a discussion of the hardware features.

### Hardware views

Shown here are examples of the front and rear of a Unity 300/300F/350F/380/380F, Unity 400/400F/450F, Unity 500/500F/550F, and Unity 600/600F/650F platform disk processor enclosure (DPE).

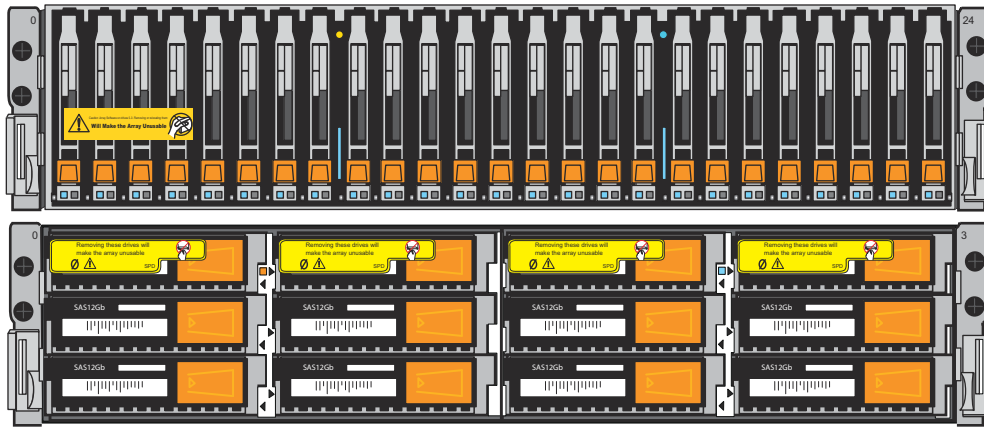

Figure 1. Disk processor enclosure front views

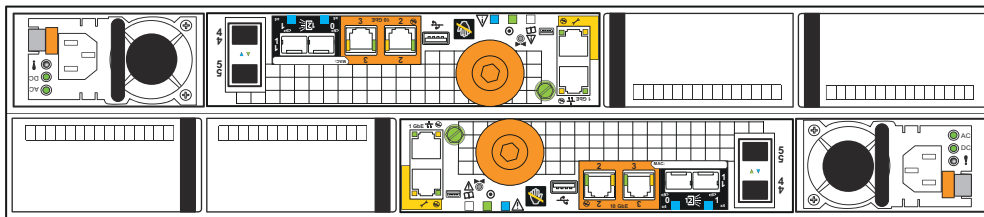

Figure 2. Disk processor enclosure rear view

**NOTE:** These figures are examples of the front and rear views without any DAEs attached and are for illustrative purposes only.

## Hardware features

Contained in a 2U architecture, the Unity™ All Flash and Unity Hybrid platform DPE fully loaded with hard disk drives and without I/O modules or DAEs weighs either:

- 12-drive DPE: 65 lb (29 kg)
- **NOTE:** 12-drive DPE not available on the Unity All Flash models.
- 25-drive DPE: 44 lb (20 kg)

The 2U DPE measures:

- 12-drive DPE: 3.4 inches high x 17.5 inches wide x 27 inches deep (8.64 cm x 44.45 cm x 68.58 cm)
- 25-drive DPE: 3.4 inches high x 17.5 inches wide x 24.17 inches deep (8.64 cm x 44.45 cm x 61.39 cm)

Between the front and rear of the enclosure, a midplane distributes power and signals to all the enclosure components. On the front DPE, drives plug directly into the midplane connections. On the rear of the DPE, the storage processors, power supply modules, and I/O modules plug directly into the midplane connections. Internal to each storage processor are a battery backup unit (BBU), redundant cooling modules, DDR4 memory, and an E5 v3 Intel processor.

The following table describes the hardware limits for Unity All Flash models.

**Table 1. Hardware limits per Unity All Flash model**

Limit description	Unity 300F	Unity 350F	Unity 400F	Unity 450F	Unity 500F	Unity 550F	Unity 600F	Unity 650F
CPU type in SP	6-core 1.6 GHz (E5-2603)	6-core 1.7 GHz (E5-2603)	8-core 2.4 GHz (E5-2630)	10-core 2.2 GHz (E5-2630)	10-core 2.6 GHz (E5-2660)	14-core 2.0 GHz (E5-2660)	12-core 2.5 GHz (E5-2680)	14-core 2.4 GHz (E5-2680)
Memory per SP	24 GB	48 GB	48 GB	64 GB	64 GB	128 GB	128 GB	256 GB
	Three 8 GB DDR4 DIMMs	Three 16 GB DDR4 DIMMs	Three 16 GB DDR4 DIMMs	Four 16 GB DDR4 DIMMs	Four 16 GB DDR4 DIMMs	Four 32 GB DDR4 DIMMs	Four 32 GB DDR4 DIMMs	Four 64 GB DDR4 DIMMs
Embedded CNA ports per SP	2 ports, configurable as either: 8/16 Gb Fibre Channel 4/8/16 Gb Fibre Channel 16 Gb Fibre Channel (single mode) 1/10 Gb IP/iSCSI							
Embedded 10GbaseT ports per SP	2 ports							
Max. SAS I/O ports per SP	2 (2 embedded mini-HD SAS ports)				6 (2 embedded and 4 I/O mini HD SAS ports)			
Max. number of I/O modules per SP	2							
Supported Back-End I/O modules	None				Four-port 12-Gb/s SAS			
Supported Front-End I/O modules	Four-port 16-Gb/s Fibre Channel Four-port 10-Gb/s optical Four-port 10GBASE-T Four-port 1GBASE-T Two-port 10Gb/s optical							
Max. number of Front-End ports per SP (all types)	12							
Max. number of Front-End Fibre Channel ports per SP (CNA and I/O modules)	10							
Max. number of Front-End ports 1GbaseT/iSCSI ports per SP (Onboard, CNA, and I/O modules)	8							
Max. number of Front-End ports 10GbE iSCSI ports per SP (Onboard, CNA, and I/O modules)	12							
(Dell Unity OE 4.1 and later) Min./Max. number of drives <sup>a</sup>	5/150	5/150	5/250	5/250	5/500	5/500	5/1000	5/1000
(Dell Unity OE 4.0 only) Min./Max. number of drives	5/150	N/A	5/250	N/A	5/350	N/A	5/500	N/A



**Table 1. Hardware limits per Unity All Flash model (continued)**

Limit description	Unity 300F	Unity 350F	Unity 400F	Unity 450F	Unity 500F	Unity 550F	Unity 600F	Unity 650F
Disk-array enclosures types supported	2U 25-drive DAE with 2.5-inch drives 3U 80-drive DAE with 2.5-inch drives							
Max. number of 2U 25-drive DAEs supported	5	5	9	9	19	19	39	39
Max. number of 3U 80-drive DAEs supported	1	1	2	2	5	5	12	12
Max. raw capacity (PB)	2.4	2.4	4	4	8	8	16	16

- a. The minimum number of drives required to create a 4+1 RAID group is five. Four drives are required for starting up the array.

The following table describes the hardware limits for Unity Hybrid models.

**Table 2. Hardware limits per Unity Hybrid model**

Limit description	Unity 300	Unity 400	Unity 500	Unity 600
CPU type in SP	6-core 1.6 GHz (E5-2603)	8-core 2.4 GHz (E5-2630)	10-core 2.6 GHz (E5-2660)	12-core 2.5 GHz (E5-2680)
Memory per SP	24 GB	48 GB	64 GB	128 GB
	Three 8 GB DDR4 DIMMs	Three 16 GB DDR4 DIMMs	Four 16 GB DDR4 DIMMs	Four 32 GB DDR4 DIMMs
Embedded CNA ports per SP	2 ports, configurable as either: 8/16 Gb Fibre Channel 4/8/16 Gb Fibre Channel 16 Gb Fibre Channel (single mode) 1/10 Gb IP/iSCSI			
Embedded 10GbaseT ports per SP	2 ports			
Max. SAS I/O ports per SP	2 (2 embedded mini-HD SAS ports)	2 (2 embedded mini-HD SAS ports)	6 (2 embedded and 4 I/O mini-HD SAS ports)	6 (2 embedded and 4 I/O mini-HD SAS ports)
Max. number of I/O modules per SP	2			
Supported Back-End I/O modules	None		Four-port 12-Gb/s SAS	
Supported Front-End I/O modules	Four-port 16-Gb/s Fibre Channel Four-port 10-Gb/s optical Four-port 10GBASE-T Four-port 1GBASE-T Two-port 10Gb/s optical			
Max. number of Front-End ports per SP (all types)	12			
Max. number of Front-End Fibre Channel ports per SP (CNA and I/O modules)	10			
Max. number of Front-End ports 1GbaseT/iSCSI ports per SP (Onboard, CNA, and I/O modules)	8			
Max. number of Front-End ports 10GbE iSCSI ports per SP (Onboard, CNA, and I/O modules)				
Min./Max. number of drives	5/150	5/250	5/500	5/1000
Disk-array enclosures types supported	2U 25-drive DAE with 2.5-inch drives 3U 15-drive DAE with 3.5-inch drives 3U 80-drive DAE with 2.5-inch drives			
Max. number of DAEs supported per system <sup>a</sup>	up to 9	up to 15	up to 33	up to 59
Max. number of 80-drive DAEs supported per system	1	2	5	12
Max. raw capacity (PB)	2.4	4	8	16

a. Depending on the DPE and DAE types in the system. Maximum DAE limits shown here use the 12-drive DPE and 15-drive DAE. Higher capacity DPE/DAEs support fewer maximum DAEs.

The Unity™ All Flash and Unity Hybrid platform includes the following hardware features:

## One 2U disk processor enclosure

On the front of the 2U DPE:

- Unity Hybrid models support two types of drive carriers in the DPE with either:
  - 12 slots for 3.5-inch drives
  - 25 slots for 2.5-inch drives
- Unity All Flash models support only the DPE and drive carrier with 25 slots for 2.5-inch drives.
- Two enclosure LEDs; power on and fault.

On the rear of the 2U DPE are two storage processors. Each storage processor consists of:

- Two RJ-45 LAN connectors (labeled with a network management symbol and a wrench symbol) management ports
- Two 10GBASE-T ports
- Two embedded Converged Network Adapter (CNA) ports
- Two embedded x4 lane 12-Gb/s mini-HD SAS (encryption capable) back-end ports (labeled 0 and 1, respectively)
- One power supply module (hot-swappable)
- Two PCI Gen 3, x8 lane I/O module slots (A0 - A1 and B0 - B1) are available for use, supporting:
  - Four-port 12-Gb/s SAS I/O module -- where supported, provides four mini-HD SAS ports (x16 lane) of 12Gb SAS expansion for connecting additional DAEs. This I/O module also supports controller based encryption. Labeled 12Gb SAS v1.
  - Four-port 16-Gb/s Fibre Channel I/O module -- provides Fibre Channel connectivity as listed below. Labeled 16Gb Fibre v3.
    - Four ports auto-negotiating to 4/8/16Gbps. Uses optical SFP+ and OM2/OM3 cabling to connect directly to a host HBA or FC switch.
    - One FC port negotiating to 16Gbps, which can be configured for synchronous replication between two Unity systems, either directly connected or connected through a switch. Uses optical SFP+ and SM or MM cabling to provide synchronous replication. The three remaining ports auto-negotiate to 4/8/16 Gbps, and use optical SFP+ and OM2/OM3 cabling to connect directly to a HBA or FC switch.
  - Four-port 10-Gb/s optical I/O module -- provides four SFP+ optical or Active/Passive TwinAx 10GbE IP/iSCSI ports for connections to an Ethernet switch. Supports both IP(file) and iSCSI (Block) on the same I/O module. Ports can be configured as both IP and iSCSI simultaneously. Labeled 10 GbE v5.
  - Four-port 10GBASE-T I/O module -- provides four copper 10GBASE-T RJ45 Ethernet ports for copper connections to an Ethernet switch. Supports both IP (file) and iSCSI (Block) on the same IO module. Ports can be configured as both IP and iSCSI simultaneously. Labeled 10GbE BaseT v2.
  - Four-port 1GBASE-T I/O module -- provides four 1000BASE-T RJ-45 copper ports for Cat 5/6-cabling connections to an Ethernet switch. Supports both IP (file) and iSCSI (Block) on the same I/O module. Ports can be configured as both IP and iSCSI simultaneously. Labeled 1 GbE BaseT v3.
  - Two-port 10Gb/s optical I/O module -- provides two SFP+ optical or Active/Passive TwinAx 10GbE ports for connections to an Ethernet switch. Supports both IP (file) and full iSCSI Offload engine (Block) on the same IO module. Ports can be configured as both IP and iSCSI simultaneously. Labeled 10 GbE V6.

## Expansion disk-array enclosures

Each model supports a different number of drive slots and DAEs.

- Unity 300F/350F and Unity 300 - 150 drive slots
- Unity 400F/450F and Unity 400 - 250 drive slots
- Unity 500F/550F and Unity 500 - 500 drive slots
- Unity 600F/650F and Unity 600 - 1000 drive slots

The number of DAEs supported by the Unity™ All Flash and Unity Hybrid is variable depending on the drive type in the DPE and DAEs. A Dell Unity™ All Flash and Unity Hybrid system cannot be configured with more drive slots than supported and will fault the DAE that contains the slots above the system limits.

Unless the array is restricted by its slot count, each back-end loop could contain:

- Ten 3U, 15-drive DAEs (150 slots)
- Ten 2U, 25-drive DAEs (250 slots)
- Three 3U, 80-drive DAEs (240 slots)

# Technical specifications

This section provides the technical specifications for the platform components.

## Topics:

- Dimensions and weights
- Power requirements
- System operating limits
- Shipping and storage requirements

## Dimensions and weights

Plan your rack and system placement using these component weight and dimension information.

### 2U, 12-drive disk processor enclosure (DPE)

**Table 3. DPE with 12 3.5" Disks, dimensions and weight**

Dimensions	Vertical size	Weight (see note)
Height: 3.40 in (8.64 cm)	2 NEMA units	65.8 lb (29.8 kg)
Width: 17.50 in (44.45 cm)		
Depth: 27.0 in (68.58 cm)		
Note: The weight does not include mounting rails. Allow 2.3-4.5 kg (5-10 lb) for a rail set. The weights listed in this table do not describe enclosures with solid state disk drives with Flash memory (called Flash or SSD drives). These Flash drive modules weigh 20.8 ounces (1.3 lb) each.		

### 2U, 25-drive disk processor enclosure (DPE)

**Table 4. DPE with 25 2.5" Disks, dimensions and weight**

Dimensions	Vertical size	Weight (see note)
Height: 3.40 in (8.64 cm)	2 NEMA units	44.0 lb (20.0 kg)
Width: 17.50 in (44.45 cm)		
Depth: 24.17 in (61.39 cm)		
Note: The weight does not include mounting rails. Allow 2.3-4.5 kg (5-10 lb) for a rail set. The weights listed in this table do not describe enclosures with solid state disk drives with Flash memory (called Flash or SSD drives). These Flash drive modules weigh 20.8 ounces (1.3 lb) each.		

### 3U, 15-drive disk-array enclosure (DAE)

**Table 5. Dimensions and weight**

Dimensions	Vertical size	Weight (see note)
Height: 5.25 in (13.34 cm)	3 NEMA units	68 lb (30.8 kg) with 15 disks
Width: 17.62 in (44.75 cm)		

**Table 5. Dimensions and weight (continued)**

Dimensions	Vertical size	Weight (see note)
Depth: 14.0 in (35.6 cm)		
Note: The weight does not include mounting rails. Allow 5-10 lb (2.3-4.5 kg) for a rail set. The weights listed in this table do not describe enclosures with solid state disk drives with Flash memory (called Flash or SSD drives). These Flash drive modules weigh 20.8 ounces (1.3 lb) each.		

## 2U, 25-drive disk-array enclosure (DAE)

**Table 6. Dimensions and weight**

Dimensions	Vertical size	Weight (see note)
Height: 3.40 in (8.64 cm)	2 NEMA units	44.61 lb (20.23 kg) with 25 disks
Width: 17.50 in (44.45 cm)		
Depth: 14.0 in (35.56 cm)		
Note: The weight does not include mounting rails. Allow 5-10 lb (2.3-4.5 kg) for a rail set. The weights listed in this table do not describe enclosures with solid state disk drives with Flash memory (called Flash or SSD drives). These Flash drive modules weigh 20.8 ounces (1.3 lb) each.		

## 3U, 80-drive disk-array enclosure (DAE)

**Table 7. DAE with 80 2.5" Disks, dimensions and weight**

Dimensions <sup>a</sup>	Vertical size	Weight <sup>b</sup>
Height: 5.2 in (20.0 cm)	3 NEMA units	<ul style="list-style-type: none"> <li>Weight with all CRU/FRUs and 80 2.5" drives populated: 130 lbs (59 kg)</li> <li>Weight of empty chassis with all CRU/FRUs and drives removed: 25 lbs (11.3 kg)</li> </ul>
Width: 17.6 in (44.7 cm)		
Depth: 30 in (76.2 cm)		

a. Dimensions are of enclosure chassis only. Dimensions do not include bezel mounting hardware.

b. Full system weight does not include mounting rails. Allow 5–10 lbs (2.3–4.5 kg) for a rail set.

## Power requirements

Plan your rack and system placement using these component power requirements.

The input current, power (VA), and dissipation per enclosure listed in this document are based on measurements of fully configured enclosures under worst-case operating conditions. Use the operating maximum values to plan the configuration of your storage system. These values represent either:

- values for a single power supply line cord, or
- the sum of the values shared by the line cords of the combined power supplies in the same enclosure, with the division between the line cords and supplies at the current sharing ratio (approximately 50% each).

Use the provided [power and weight calculator](#) to refine the power and heat values in the following tables to more-closely match the hardware configuration for your system.

A failure of one of the combined power supplies per enclosure results in the remaining power supply supporting the full load. You must use a rackmount cabinet or rack with appropriate power distribution, and have main branch AC distribution that can handle these values for each enclosure in the cabinet.

All power figures shown represent a worst case product configuration with max normal values operating in an ambient temperature environment of 20°C to 25°C.

The chassis power numbers provided may increase when operating in a higher ambient temperature environment.

## Unity 2U disk processor enclosure (DPE)

**Table 8. 25-drive slot disk processor AC enclosure power specifications**

	<b>Unity 300F   Unity 300</b>	<b>Unity 400F   Unity 400</b>	<b>Unity 500F   Unity 500</b>	<b>Unity 600F   Unity 600</b>
AC line voltage	100 to 240 VAC ± 10%, single phase, 47 to 63 Hz			
AC line current (operating maximum)	9.04 A max at 100 VAC	9.09 A max at 100 VAC	9.55 A max at 100 VAC	9.89 A max at 100 VAC
	4.48 A max at 200VAC	4.55 A max at 200VAC	4.78 A max at 200VAC	4.89 A max at 200VAC
Power consumption (operating maximum)	907.5 VA (903.5 W) max at 100 VAC	909.0 VA (905.0 W) max at 100 VAC	955.0 VA (951.0 W) max at 100 VAC	989.0 VA (985.0 W) max at 100 VAC
	907.5 VA (895.5 W) max at 200 VAC	909.0 VA (897.0 W) max at 200 VAC	955.0 VA (943.0 W) max at 200 VAC	989.0 VA (977.0 W) max at 200 VAC
Power factor	0.95 mi at full load 100/ 200 VAC			
Heat dissipation (operating maximum)	3.25 x 10 <sup>6</sup> J/hr, (3,083 Btu/hr) max at 100 VAC; 3.22 x 10 <sup>6</sup> J/hr, (3,056 Btu/hr) max (100V*)	3.26 x 10 <sup>6</sup> J/hr, (3,088 Btu/hr) max at 100 VAC; 3.23 x 10 <sup>6</sup> J/hr, (3,061 Btu/hr) max (100V*)	3.42 x 10 <sup>6</sup> J/hr, (3,245 Btu/hr) max at 100 VAC; 3.40 x 10 <sup>6</sup> J/hr, (3,218 Btu/hr) max (100V*)	3.55 x 10 <sup>6</sup> J/hr, (3,361 Btu/hr) max at 100 VAC; 3.52 x 10 <sup>6</sup> J/hr, (3,334 Btu/hr) max (100V*)
In-rush current	45 Apk "cold" per line cord, at any line voltage			
Startup surge current	120 Apk "hot" per line cord, at any line voltage			
AC protection	15 A fuse on each power supply, single line			
AC inlet type	IEC320-C14 appliance coupler, per power zone			
Ride-through time	10 ms min			
Current sharing	± 5 percent of full load, between power supplies			

**Table 9. 12-drive slot disk processor enclosure AC power specifications**

	<b>Unity 300</b>	<b>Unity 400</b>	<b>Unity 500</b>	<b>Unity 600</b>
AC line voltage	100 to 240 VAC ± 10%, single phase, 47 to 63 Hz			
AC line current (operating maximum)	6.94 A max at 100 VAC	6.95 A max at 100 VAC	7.41 A max at 100 VAC	7.80 A max at 100 VAC
	3.59 A max at 200VAC	3.60 A max at 200VAC	3.83 A max at 200VAC	4.00 A max at 200VAC
Power consumption (operating maximum)	693.5 VA (678.5 W) max at 100 VAC	695.0 VA (681.0 W) max at 100 VAC	741.0 VA (727.0 W) max at 100 VAC	775.0 VA (761.0 W) max at 100 VAC
	718.5 VA (678.5 W) max at 200 VAC	720.0 VA (680.0 W) max at 200 VAC	766.0 VA (726.0 W) max at 200 VAC	800.0 VA (760.0 W) max at 200 VAC
Power factor	0.95 mi at full load 100/ 200 VAC			
Heat dissipation (operating maximum)	2.45 x 10 <sup>6</sup> J/hr, (2,319 Btu/hr) max at 100 VAC; 2.44 x 10 <sup>6</sup> J/hr, (3,313 Btu/hr) max (100V*)	2.45 x 10 <sup>6</sup> J/hr, (2,324 Btu/hr) max at 100 VAC; 2.45 x 10 <sup>6</sup> J/hr, (2,320 Btu/hr) max (100V*)	2.62 x 10 <sup>6</sup> J/hr, (2,481 Btu/hr) max at 100 VAC; 2.61 x 10 <sup>6</sup> J/hr, (2,477 Btu/hr) max (100V*)	2.74 x 10 <sup>6</sup> J/hr, (2,597 Btu/hr) max at 100 VAC; 2.74 x 10 <sup>6</sup> J/hr, (2,593 Btu/hr) max (100V*)
In-rush current	45 Apk "cold" per line cord, at any line voltage			
Startup surge current	120 Apk "hot" per line cord, at any line voltage			
AC protection	15 A fuse on each power supply, single line			
AC inlet type	IEC320-C14 appliance coupler, per power zone			

**Table 9. 12-drive slot disk processor enclosure AC power specifications (continued)**

	Unity 300	Unity 400	Unity 500	Unity 600
Ride-through time	10 ms min			
Current sharing	± 5 percent of full load, between power supplies			

**Table 10. 25-drive slot disk processor enclosure DC power specifications**

	Unity 300	Unity 400	Unity 500	Unity 600
DC line voltage	DC Line Voltage -39 to -72 V DC (Nominal -48V or -60V power systems)			
DC line current (operating maximum)	23.7 A max at -39 V DC; 18.8 A max at -48 V DC; 12.8 A max at -72 V DC	23.7 max at -39 V DC; 18.9 A max at -48 V DC; 12.8 A max at -72 V DC	24.9 max at -39 V DC; 19.8 A max at -48 V DC; 13.5 A max at -72 V DC	25.8 max at -39 V DC; 20.6 A max at -48 V DC; 14.0 A max at -72 V DC
Power consumption (operating maximum)	923 W max at -39 V DC; 905 W max at -48 V DC; 921 W max at -72 V DC	925 W max at -39 V DC; 906 W max at -48 V DC; 922 W max at -72 V DC	972 W max at -39 V DC; 953 W max at -48 V DC; 970 W max at -72 V DC	1,006 W max at -39 V DC; 987 W max at -48 V DC; 1,005 W max at -72 V DC
Heat dissipation (operating maximum)	3.32 x 10 <sup>6</sup> J/hr, (3,150 Btu/hr) max at -39 V DC; 3.26 x 10 <sup>6</sup> J/hr, (3,088 Btu/hr) max at -48 V DC; 3.32 x 10 <sup>6</sup> J/hr, (3,142 Btu/hr) max at -72 V DC	3.33 x 10 <sup>6</sup> J/hr, (3,156 Btu/hr) max at -39 V DC; 3.26 x 10 <sup>6</sup> J/hr, (3,091 Btu/hr) max at -48 V DC; 3.32 x 10 <sup>6</sup> J/hr, (3,146 Btu/hr) max at -72 V DC	3.50 x 10 <sup>6</sup> J/hr, (3,317 Btu/hr) max at -39 V DC; 3.43 x 10 <sup>6</sup> J/hr, (3,252 Btu/hr) max at -48 V DC; 3.49 x 10 <sup>6</sup> J/hr, (3,310 Btu/hr) max at -72 V DC	3.62 x 10 <sup>6</sup> J/hr, (3,433 Btu/hr) max at -39 V DC; 3.55 x 10 <sup>6</sup> J/hr, (3,368 Btu/hr) max at -48 V DC; 3.62 x 10 <sup>6</sup> J/hr, (3,429 Btu/hr) max at -72 V DC
In-rush current	40 A peak, per requirement in EN300 132-2 Sect. 4.7 limit curve			
DC protection	50 A fuse in each power supply			
DC inlet type	Positronics PLBH3W3M4B0A1/AA			
Mating DC connector	Positronics PLBH3W3F0000/AA; Positronics Inc., <a href="http://www.connectpositronic.com">http://www.connectpositronic.com</a>			
Ride-through time	1 ms min at -50 V input			
Current sharing	± 5 percent of full load, between power supplies			

**Table 11. 12-drive slot disk processor enclosure DC power specifications**

	Unity 300	Unity 400	Unity 500	Unity 600
DC line voltage	DC Line Voltage -39 to -72 V DC (Nominal -48V or -60V power systems)			
DC line current (operating maximum)	18.0 A max at -39 V DC; 14.5 A max at -48 V DC; 9.8 A max at -72 V DC	17.9 A max at -39 V DC; 14.4 A max at -48 V DC; 9.8 A max at -72 V DC	19.3 max at -39 V DC; 15.4 A max at -48 V DC; 10.5 A max at -72 V DC	20.2 max at -39 V DC; 16.2 A max at -48 V DC; 11.0 A max at -72 V DC
Power consumption (operating maximum)	701 W max at -39 V DC; 695 W max at -48 V DC; 706 W max at -72 V DC	700 W max at -39 V DC; 693 W max at -48 V DC; 704 W max at -72 V DC	751 W max at -39 V DC; 741 W max at -48 V DC; 753 W max at -72 V DC	789 W max at -39 V DC; 776 W max at -48 V DC; 789 W max at -72 V DC
Heat dissipation (operating maximum)	2.52 x 10 <sup>6</sup> J/hr, (2,392 Btu/hr) max at -39 V DC; 2.50 x 10 <sup>6</sup> J/hr, (2,370 Btu/hr) max at -48 V DC; 2.54 x 10 <sup>6</sup> J/hr, (2,409 Btu/hr) max at -72 V DC	2.52 x 10 <sup>6</sup> J/hr, (2,388 Btu/hr) max at -39 V DC; 2.49 x 10 <sup>6</sup> J/hr, (2,365 Btu/hr) max at -48 V DC; 2.53 x 10 <sup>6</sup> J/hr, (2,402 Btu/hr) max at -72 V DC	2.70 x 10 <sup>6</sup> J/hr, (2,562 Btu/hr) max at -39 V DC; 2.67 x 10 <sup>6</sup> J/hr, (2,528 Btu/hr) max at -48 V DC; 2.71 x 10 <sup>6</sup> J/hr, (2,569 Btu/hr) max at -72 V DC	2.84 x 10 <sup>6</sup> J/hr, (2,692 Btu/hr) max at -39 V DC; 2.79 x 10 <sup>6</sup> J/hr, (2,648 Btu/hr) max at -48 V DC; 2.84 x 10 <sup>6</sup> J/hr, (2,692 Btu/hr) max at -72 V DC
In-rush current	40 A peak, per requirement in EN300 132-2 Sect. 4.7 limit curve			
DC protection	50 A fuse in each power supply			

**Table 11. 12-drive slot disk processor enclosure DC power specifications (continued)**

	Unity 300	Unity 400	Unity 500	Unity 600
DC inlet type	Positronics PLBH3W3M4B0A1/AA			
Mating DC connector	Positronics PLBH3W3F0000/AA; Positronics Inc., <a href="http://www.connectpositronic.com">http://www.connectpositronic.com</a>			
Ride-through time	1 ms min at -50 V input			
Current sharing	± 5 percent of full load, between power supplies			

### 3U, 15-drive disk-array enclosure (DAE)

**Table 12. 15-drive slot disk array enclosure AC power specifications**

Requirement	Description
AC line voltage	100 to 240 VAC ± 10%, single phase, 47 to 63 Hz
AC line current (operating maximum)	2.90 A max at 100 VAC
	1.60 A max at 200 VAC
Power consumption (operating maximum)	287.0 VA 281.0 W max at 100 VAC
	313.0 VA 277.0 W max at 200VAC
Power factor	0.90 minimum at full load, 100V/200V
Heat dissipation (operating maximum)	1.01 x 10 <sup>6</sup> J/hr, (959 Btu/hr) max at 100 VAC
	100.0 x 10 <sup>6</sup> J/hr, (945 Btu/hr) max at 200 VAC
In-rush current	30 A max for ½ line cycle, per line cord at 240 VAC
Startup surge current	25 Amps peak max per line cord, at any line voltage
AC protection	10 A fuse on each power supply, both Line and Neutral
AC inlet type	IEC320-C14 appliance coupler, per power zone
Ride-through time	30 ms minimum
Current sharing	Droop Load Sharing

**Table 13. 15-drive slot disk array enclosure DC power specifications**

Requirement	Description
DC line voltage	-39 to -72V DC (nominal -48 or -60 V power systems)
DC line current (operating maximum)	7.92 A max at -39V DC
	6.43 A max at -48V DC
	4.39 A max at -72V DC
Power consumption (operating maximum)	309 W max at -39V DC
	309 W max at -48V DC
	316 W max at -72V DC
Heat dissipation (operating maximum)	1.11 x 10 <sup>6</sup> J/hr (1054 Btu/hr) max at -39V DC
	1.11 x 10 <sup>6</sup> J/hr (1054 Btu/hr) max at -48V DC
	1.14 x 10 <sup>6</sup> J/hr (1078 Btu/hr) max at -72V DC
In-rush current	20 A peak per requirements in EN300 132-2 Sect 4.7 limit curve
DC protection	20 A fuse in each power supply



**Table 13. 15-drive slot disk array enclosure DC power specifications (continued)**

Requirement	Description
DC inlet type	Positronics PLB3W3M1000
Mating DC connector	Positronics PLB3W3F7100A1; Positronics Inc., <a href="http://www.connectpositronic.com">http://www.connectpositronic.com</a>
Ride-through time	5 ms min. (test condition: Vin = -40V DC)
Current sharing	Droop Load Sharing

## 2U, 25-drive disk-array enclosure (DAE)

**Table 14. 25-drive slot disk array enclosure AC power specifications**

Requirement	Description
AC line voltage	100 to 240 VAC $\pm$ 10%, single phase, 47 to 63 Hz
AC line current (operating maximum)	4.50 A max at 100 VAC
	2.40 A max at 200 VAC
Power consumption (operating maximum)	453.0 VA 432.0 W max at 100 VAC
	485.0 VA 427.0 W max at 200VAC
Power factor	0.95 minimum at full load, 100V/200V
Heat dissipation (operating maximum)	1.56 x 10 <sup>6</sup> J/hr, (1,474 Btu/hr) max at 100 VAC
	154.0 x 10 <sup>6</sup> J/hr, (1,457 Btu/hr) max at 200 VAC
In-rush current	30 A max for ½ line cycle, per line cord at 240 VAC
Startup surge current	40 Amps peak max per line cord, at any line voltage
AC protection	15 A fuse on each power supply, both Line and Neutral
AC inlet type	IEC320-C14 appliance coupler, per power zone
Ride-through time	12 ms minimum
Current sharing	$\pm$ 5 percent of full load, between power supplies

**Table 15. 25-drive slot disk array enclosure DC power specifications**

Requirement	Description
DC line voltage	-39 to -72 V DC (Nominal -48V or -60V power systems)
DC line current (operating maximum)	11.0 max at -39 V DC; 9.10 A max at -48 V DC; 6.2 A max at -72 V DC
Power consumption (operating maximum)	428 W max at -39 V DC; 437 W max at -48 V DC; 448 W max at -72 V DC
Heat dissipation (operating maximum)	1.54 x 10 <sup>6</sup> J/hr, (1,460 Btu/hr) max at -39 V DC; 1.57 x 10 <sup>6</sup> J/hr, (1,491 Btu/hr) max at - 48 V DC; 1.61 x 10 <sup>6</sup> J/hr, (1,529 Btu/hr) max at -72 V DC
In-rush current	40 A peak, per requirement in EN300 132-2 Sect. 4.7 limit curve
DC protection	50 A fuse in each power supply
DC inlet type	Positronics PLBH3W3M4B0A1/AA
Mating DC connector	Positronics PLBH3W3F0000/AA; Positronics Inc., <a href="http://www.connectpositronic.com">http://www.connectpositronic.com</a>

**Table 15. 25-drive slot disk array enclosure DC power specifications (continued)**

Requirement	Description
Ride-through time	1 ms min at -50 V input
Current sharing	± 5 percent of full load, between power supplies

## 3U, 80-drive disk-array enclosure (DAE)

**Table 16. 80-drive disk-array enclosure AC power specifications**

Requirement	Description
AC line voltage	200 to 240 V AC ± 10%, single-phase, 47 to 63 Hz
AC line current (operating maximum)	8.06 A max at 200 V AC
Power consumption (operating maximum)	1,611 VA (1,564 W) max
Power factor	0.98 min at full load, low voltage
Heat dissipation	5.63 x 10 <sup>6</sup> J/hr (5,337 Btu/hr) max
In-rush current	30 A max for ½ line cycle, per line cord at 240 V AC
Startup surge current	25 A rms max for 100 ms, per line cord at any line voltage
AC protection	12 A fuse on each line cord, both phases
AC inlet type	IEC320-C14 appliance coupler, two per power zone
Ride-through time	12 msec per minute per power supply
Current sharing	± 10% of full load, between power supplies

Note: Ratings assume a fully configured 80-drive DAE that includes 4 power supplies, 2 LCCs, and 80 disk drives.

## System operating limits

The ambient temperature specification is measured at the rear inlet. The site must have air conditioning of the correct size and placement to maintain the specified ambient temperature range and offset the heat dissipation listed below.

**Table 17. System operating limits**

Requirement	Description
Ambient temperature	10° C to 50° C (50° F to 122° F) <sup>1</sup>
Temperature gradient	10° C/hr (18° F/hr)
Relative humidity (extremes)	20% to 80% noncondensing
Relative humidity (recommended <sup>2</sup> )	40% to 50% noncondensing
Elevation	-50 to 10,000 ft (-16 to 3,048 m)

<sup>1</sup> - See [High ambient temperature shutdown](#) for system behavior at high ambient temperatures. <sup>2</sup> - The allowable relative humidity level is 20 to 80% noncondensing. However, the recommended operating environment range is 40 to 55%. To minimize the risk of hardware corrosion and degradation, we recommend lower temperatures and humidity for data centers with gaseous contamination such as high sulfur content. In general, the humidity fluctuations within the data center should be minimized. We also recommend that the data center be positively pressured and have air curtains on entry ways to prevent outside air contaminants and humidity from entering the facility. For facilities below 40% relative humidity, we recommend grounding straps when contacting the equipment to avoid the risk of electrostatic discharge (ESD), which can harm electronic equipment.

**NOTE:** For systems mounted in a cabinet, the operating limits listed above must not be exceeded inside the closed cabinet. Equipment mounted directly above or below an enclosure must not restrict the front-to-rear airflow of the storage system.

Cabinet doors must not impede the front-to-rear airflow. The cabinet must exhaust air at a rate that is equal to or greater than the sum of the exhaust rates of all the equipment mounted in the cabinet.

**Table 18. High ambient temperature shutdown**

Ambient temperature	Hardware fault	Consequence
Above 62° C (143° F)	None	System shuts down
52° C (125° F)	None	System cache disabled
50° C (122° F)	Single fan fault	System shuts down
Any	Multiple fan faults	System shuts down after five minute timer expires for destaging cache

## DPE airflow

The enclosure uses an adaptive cooling algorithm that increases/decreases fan speed as the unit senses changes to the external ambient temperature. Exhaust increases with ambient temperature and fan speed, and is roughly linear within recommended operating parameters. Note that the information in the table below is typical, and was measured without cabinet front/rear doors that would potentially reduce front-to-back air flow.

**Table 19. DPE airflow**

Max Airflow CFM	Min Airflow CFM	Max Power Usage (Watts)
106 CFM	40 CFM	850 W

## Environmental recovery

If the system exceeds the maximum ambient temperature by approximately 10°C (18°F), the storage processors (SPs) in the system begin an orderly shutdown that saves cached data, and then shut themselves down. Link control cards (LCCs) in each DAE in the system power down their disks but remain powered on. If the system detects that the temperature has dropped to an acceptable level, it restores power to the SPs and the LCCs restore power to their disks.

## Air quality requirements

The products are designed to be consistent with the requirements of the American Society of Heating, Refrigeration and Air Conditioning Engineers (ASHRAE) Environmental Standard Handbook and the most current revision of Thermal Guidelines for Data Processing Environments, Second Edition, ASHRAE 2009b.

Cabinets are best suited for Class 1 datacom environments, which consist of tightly controlled environmental parameters, including temperature, dew point, relative humidity and air quality. These facilities house mission-critical equipment and are typically fault-tolerant, including the air conditioners.

The data center should maintain a cleanliness level as identified in ISO 14664-1, class 8 for particulate dust and pollution control. The air entering the data center should be filtered with a MERV 11 filter or better. The air within the data center should be continuously filtered with a MERV 8 or better filtration system. In addition, efforts should be maintained to prevent conductive particles, such as zinc whiskers, from entering the facility.

The allowable relative humidity level is 20 to 80% non condensing, however, the recommended operating environment range is 40 to 55%. For data centers with gaseous contamination, such as high sulfur content, lower temperatures and humidity are recommended to minimize the risk of hardware corrosion and degradation. In general, the humidity fluctuations within the data center should be minimized. It is also recommended that the data center be positively pressured and have air curtains on entry ways to prevent outside air contaminants and humidity from entering the facility.

For facilities below 40% relative humidity, it is recommended to use grounding straps when contacting the equipment to avoid the risk of Electrostatic discharge (ESD), which can harm electronic equipment.

As part of an ongoing monitoring process for the corrosiveness of the environment, it is recommended to place copper and silver coupons (per ISA 71.04-1985, Section 6.1 Reactivity), in airstreams representative of those in the data center. The

monthly reactivity rate of the coupons should be less than 300 Angstroms. When monitored reactivity rate is exceeded, the coupon should be analyzed for material species and a corrective mitigation process put in place.

Storage time (unpowered) recommendation: do not exceed 6 consecutive months of unpowered storage.

## Fire suppressant disclaimer

Fire prevention equipment in the computer room should always be installed as an added safety measure. A fire suppression system is the responsibility of the customer. When selecting appropriate fire suppression equipment and agents for the data center, choose carefully. An insurance underwriter, local fire marshal, and local building inspector are all parties that you should consult during the selection of a fire suppression system that provides the correct level of coverage and protection.

Equipment is designed and manufactured to internal and external standards that require certain environments for reliable operation. We do not make compatibility claims of any kind nor do we provide recommendations on fire suppression systems. It is not recommended to position storage equipment directly in the path of high pressure gas discharge streams or loud fire sirens so as to minimize the forces and vibration adverse to system integrity.

**NOTE:** The previous information is provided on an “as is” basis and provides no representations, warranties, guarantees or obligations on the part of our company. This information does not modify the scope of any warranty set forth in the terms and conditions of the basic purchasing agreement between the customer and the manufacturer.

## Shock and vibration

Products have been tested to withstand the shock and random vibration levels. The levels apply to all three axes and should be measured with an accelerometer on the equipment enclosures within the cabinet and shall not exceed any of the following values.

Platform condition	Response measurement level
Non operational shock	25 Gs, 3 ms duration
Operational shock	6 Gs, 11 ms duration
Non operational random vibration	0.40 Grms, 5–500 Hz, 30 minutes
Operational random vibration	0.21 Grms, 5–500 Hz, 10 minutes

Systems that are mounted on an approved package have completed transportation testing to withstand the following shock and vibrations in the vertical direction only and shall not exceed:

Packaged system condition	Response measurement level
Transportation shock	10 Gs, 12ms duration
Transportation random vibration	<ul style="list-style-type: none"> <li>0.28 Grms</li> <li>4 hours Frequency range 1-100 Hz</li> </ul>

## Shipping and storage requirements

**CAUTION:** Systems and components must not experience changes in temperature and humidity that are likely to cause condensation to form on or in that system or component. Do not exceed the shipping and storage temperature gradient of 45°F/hr (25°C/hr).

**Table 20. Shipping and storage requirements**

Requirement	Description
Ambient temperature	-40° F to 149°F (-40°C to 65°C)
Temperature gradient	45°F/hr (25°C/hr)
Relative humidity	10% to 90% noncondensing

**Table 20. Shipping and storage requirements (continued)**

<b>Requirement</b>	<b>Description</b>
Elevation	-50 to 35,000 ft (-16 to 10,600 m)
Storage time (unpowered)	Do not exceed 6 consecutive months of unpowered storage.

# Hardware component descriptions

This section describes the Unity 300/300F/350F/380/380F, Unity 400/400F/450F, Unity 500/500F/550F, and Unity 600/600F/650F platform components. Included with the component description are illustrations and tables of the LEDs, ports or connectors, and any controls.

**i** **NOTE:** In the following sections, the illustrations and corresponding tables describe these individual components. These descriptions are for illustrative purposes only.

## Topics:

- [Disk processor enclosure](#)
- [2U DPE rear view](#)
- [Storage processor internal components](#)

## Disk processor enclosure

Two types of disk drive DPEs are supported:

- either 3.5-inch disk drives (hot-swappable)
- either 2.5-inch disk drives (hot-swappable)

**i** **NOTE:** Disk drives used in the 2U, 12 disk drive DPE cannot be interchanged with the disk drives from a 2U, 25 disk drive DPE.

**i** **NOTE:** When calculating the number of drives supported, the DPE is included in the total drive slot quantity.

Each model supports a different number of drive slots and DAEs.

- Unity 300F/350F and Unity 300 - 150 drive slots
- Unity 400F/450F and Unity 400 - 250 drive slots
- Unity 500F/550F and Unity 500 - 500 drive slots
- Unity 600F/650F and Unity 600 - 1000 drive slots

The number of DAEs supported by the Unity™ All Flash and Unity Hybrid is variable depending on the drive type in the DPE and DAEs. A Dell Unity™ All Flash and Unity Hybrid system cannot be configured with more drive slots than supported and will fault the DAE that contains the slots above the system limits.

Unless the array is restricted by its slot count, each back-end loop could contain:

- Ten 3U, 15-drive DAEs (150 slots)
- Ten 2U, 25-drive DAEs (250 slots)
- Three 3U, 80-drive DAEs (240 slots)

## General disk processor enclosure information

The DPE (disk processor enclosure) comprises the following components:

- Drive carrier
- Disk drives
- Midplane
- Storage processor (SP) CPU
- SP power supply module
- EMI shielding

## Drive carrier

The disk drive carriers are metal and plastic assemblies that provide smooth, reliable contact with the enclosure slot guides and midplane connectors. Each carrier has a handle with a latch and spring clips. The latch holds the disk drive in place to ensure proper connection with the midplane. Disk drive activity/fault LEDs are located on the front of the enclosure.

## Disk drives

Each disk drive consists of one disk drive in a carrier. You can visually distinguish between disk drive types by their different latch and handle mechanisms and by type, capacity, and speed labels on each disk drive. You can add or remove a disk drive while the DPE is powered up, but you should exercise special care when removing modules while they are in use. Disk drives are extremely sensitive electronic components.

## Midplane

A midplane separates the front-facing disk drives from the rear-facing SPs. It distributes power and signals to all components in the enclosure. SPs and disk drives plug directly into the midplane.

## Storage processor (SP) assembly

The SP assembly is the intelligent component of the DPE. Acting as the control center, each SP assembly includes status LEDs.

## SP power supply module

Each SP contains a power supply module that connect the system to an exterior power source. Each power supply includes LEDs to indicate component status. A latch on the module locks it into place to ensure proper connection.

## EMI shielding

EMI compliance requires a properly installed electromagnetic interference (EMI) shield in front of the DPE disk drives. When installed in cabinets that include a front door, the DPE includes a simple EMI shield. Other installations require a front bezel that has a locking latch and integrated EMI shield. You must remove the bezel/shield to remove and install the disk drives.

## 2U, 12 (3.5-inch) disk drive DPE

The following illustration shows the location of the disk drives and the status LEDs in a 2U, 12 (3.5-inch) disk drive DPE.



Figure 3. Example of the 2U, 12 (3.5-inch) disk drive DPE (front view)

Table 21. 2U, 12 (3.5-inch) disk drive DPE descriptions

Location	Description	Location	Description
1	3.5-inch SAS disk drive	3	DPE power on LED (blue)
2	DPE fault LED (amber)	4	Disk drive ready/activity and fault LED (blue and amber)

The following table describes the 2U, 12 (3.5-inch) disk drive DPE and the disk drive status LEDs.

Table 22. 2U, 12 (3.5-inch) DPE and disk drive LEDs

LED	Location	Color	State	Description
DPE fault	2	Amber	On	DPE fault, including SP faults.
		—	Off	Normal
DPE power	3	Blue	On	Powering and powered up
		—	Off	Powered down
Disk drive ready/activity and fault <i>i</i> <b>NOTE:</b> The disk drive LED (a left or right triangle symbol) points to the disk drive that it refers to.	4	Blue	On	Powering and powered up
			Blinking, mostly on	Disk drive is on with I/O activity on
			Blinking at constant rate	Disk drive is spinning up or down normally
			Blinking, mostly off	Disk drive is powered up but not spinning <i>i</i> <b>NOTE:</b> This is a normal part of the spin-up sequence, occurring during the spin-up delay of a slot.
		Amber	On	Fault has occurred
		—	Off	Disk drive is powered down



## Product Serial Number Tag

The Product Serial Number Tag (PSNT) is a serialized label allowing Dell service to track nested hardware material in the field. The PSNT for the 12-slot DPE is a pull-out tag that is located in the upper right side of the enclosure.

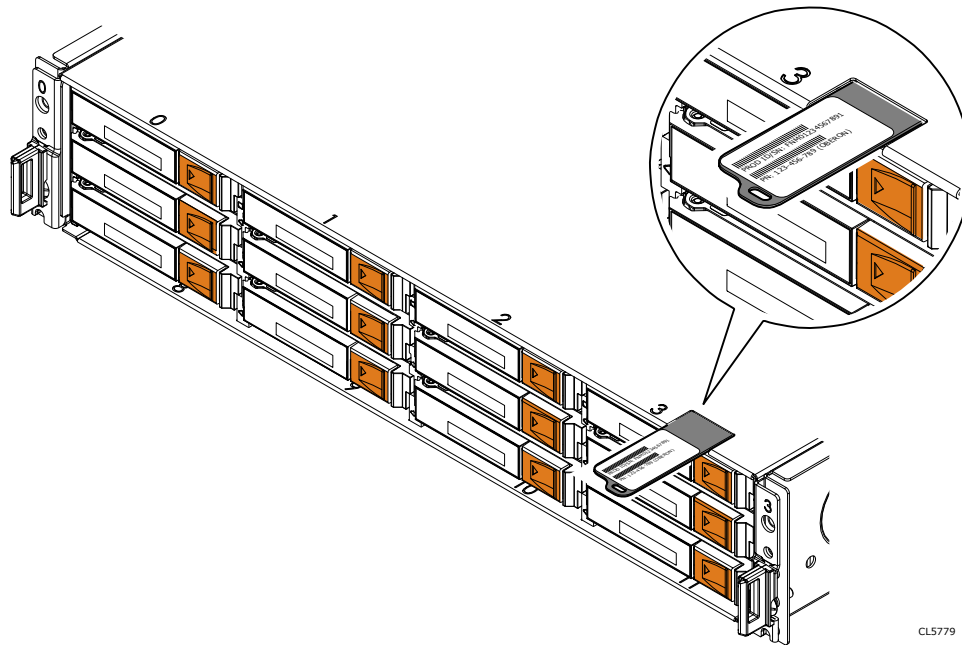

Figure 4. PSNT location

## 2U, 25 (2.5-inch) disk drive DPE

The following illustration shows the location of the disk drives and the status LEDs in a 2U, 25 (2.5-inch) disk drive DPE.

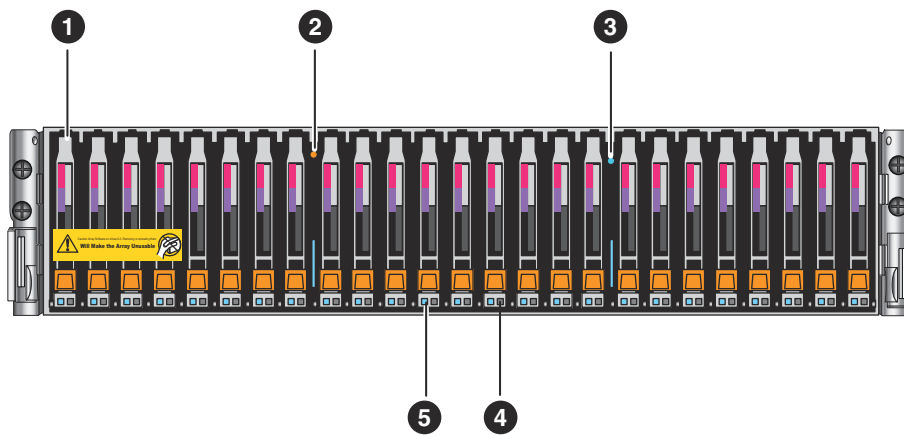

Figure 5. Example of the 2U, 25 (2.5-inch) disk drive DPE (front view)

Table 23. 2U, 25 (2.5-inch) disk drive DPE details

Location	Description	Location	Description
1	2.5-inch SAS disk drive	4	Disk drive fault LED (amber)
2	DPE fault LED (amber)	5	Disk drive ready/activity LED (blue)
3	DPE power status LED (blue)		

The following table describes the 2U, 25 (2.5-inch) disk drive DPE and the disk drive status LEDs.

**Table 24. 2U, 25 (2.5-inch) DPE and disk drive LEDs**

LED	Location	Color	State	Description
DPE fault	2	—	Off	No fault has occurred, normal operation
		Amber	On	Fault has occurred
DPE power	3	Blue	On	Powering and powered up
		—	Off	Powered down
Disk drive fault	4	Amber	On	Fault has occurred
		—	Off	No fault has occurred
Disk drive on/activity	5	Blue	On	Powering and powered up
			Blinking	Disk drive activity

## Product Serial Number Tag

The Product Serial Number Tag (PSNT) is a serialized label allowing Dell service to track nested hardware material in the field.

The PSNT for the 25-slot DPE is a pull-out tag that is located between the disk drives in slots 16 and 17.

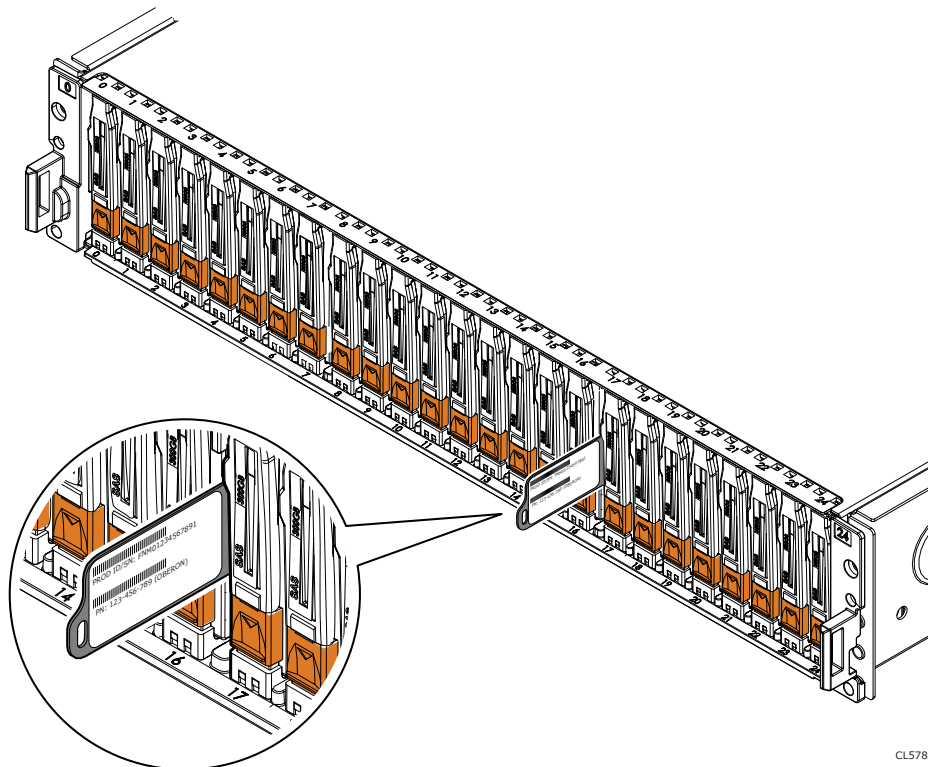

CL5780

**Figure 6. PSNT location**

## 2U DPE rear view

On the rear of the 2U DPE, viewing from top to bottom, each logical SP (B and A), consists of:

- One power supply module
- One storage processor
- up to two Ultraflex I/O modules

The following illustration shows the location of the replaceable components at the back of the DPE.

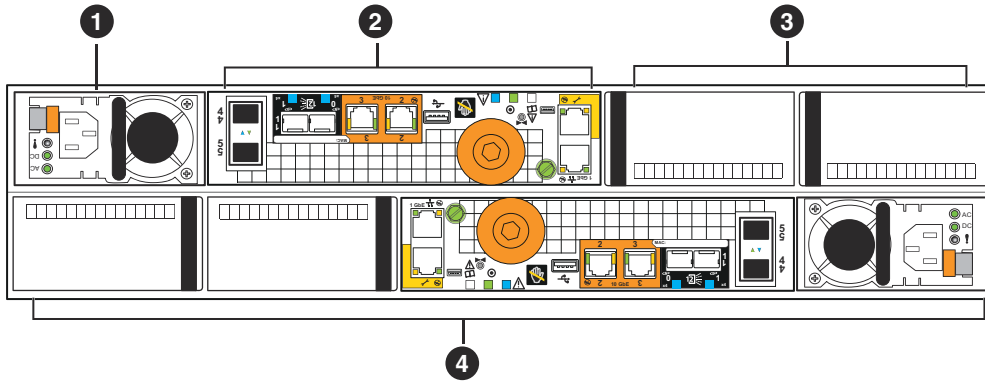

**Figure 7. DPE rear view with component locations**

**Table 25. DPE rear view descriptions**

Location	Description	Location	Description
<b>1</b>	Power supply module (SP B)	<b>3</b>	Ultraflex I/O module slots (SP B), filler modules shown
<b>2</b>	Storage processor assembly (SP B)	<b>4</b>	SP A

## Storage processor rear view

On the rear of the storage processor, viewing from left to right, are:

- Two RJ45 LAN connectors (labeled with a network management symbol and a wrench symbol) management ports
- SP status LEDs
- One mini-HDMI port and one USB 3.0 port
- Reset button (NMI)
- Two 10-GbE ports
- Two 12-Gb/s mini-SAS HD ports
- Two integrated Converged Network Adapter (CNA) ports

The following illustration shows the location of the SP components:

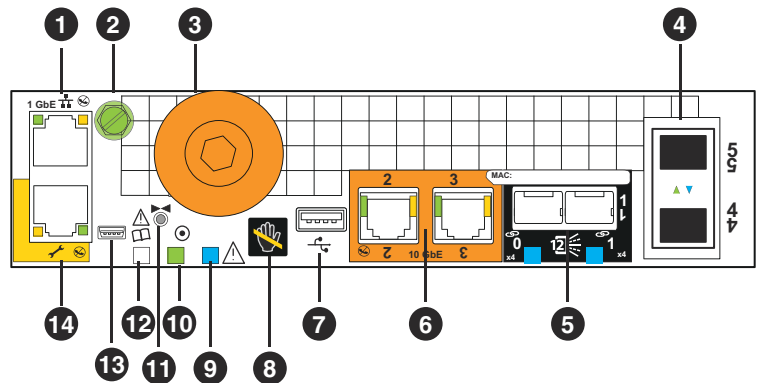

Figure 8. Example storage processor rear view

Table 26. Storage processor rear view descriptions

Location	Description	Location	Description
1	Management LAN (RJ45) port	8	SP unsafe to remove LED (black with white hand)
2	Grounding screw (required for DC-powered systems)	9	SP fault LED
3	Torque knob for SP removal	10	SP power LED
4	Two converged network adapter (CNA) ports (labeled 4 and 5)	11	Non-maskable interrupt (NMI) push button (password reset button) <sup>a</sup>
5	Two 12 Gb/s mini-SAS HD ports (labeled 0 and 1)	12	SP memory or boot fault LED
6	Two 10 GbE ports (labeled 2 and 3) <i>NOTE:</i> Unity XT 380/380F systems that are manufactured in the second half of 2022 and later, will not include these two 10 GbE ports. For more information, see the <i>Dell Unity XT: Introduction to the Platform - A Detailed Review</i> white paper on Online Support.	13	Mini-HDMI port (not used)
7	USB 3.0 port	14	Service LAN (RJ45) port

a. NMI = non-maskable interrupt, push button used for password reset and forcing a system dump. Hold for 2 seconds to reset the password. Hold for 10 seconds or more forces a reboot.

The following table describes the SP status LEDs.

Table 27. Storage processor LED details

LED	Location	Color	State	Description
SP power LED	10	Green	On	The SP is on main power.

**Table 27. Storage processor LED details (continued)**

LED	Location	Color	State	Description
			Blinking (1 Hz)	The SP is initializing a serial over LAN (SOL) session (standby mode).
		—	Off	The SP is off.
Unsafe to Remove LED	8	White	On	DO NOT remove the SP. <b>i</b> <b>NOTE:</b> Improper removal of the SP when this LED is lit could cause data loss during critical situations.
		—	Off	Safe to remove the SP without the risk of data loss when the SP has been properly prepared.
SP fault LED	9	Amber	Blinking once every four seconds (.25 Hz)	BIOS is running.
			Blinking once every second (1 Hz)	POST is running.
			Blinking four times every second (4 Hz)	POST has completed, and operating system boot has started.
			On	An SP fault is detected.
		Blue	Blinking once every four seconds (.25 Hz)	Operating system is booting.
			Blinking once every second (1 Hz)	Operating system driver is starting.
			Blinking four times every second (4 Hz)	Operating system caching driver is starting.
			On	<ul style="list-style-type: none"> <li>SP is in degraded mode.</li> <li>System is not initialized. A management IP address is assigned.</li> </ul> <b>i</b> <b>NOTE:</b> Once the license is accepted, the SP fault LED turns off.
		—	Off	All operating system software has booted, and the SP is ready for I/O.
		Amber and blue	Alternating at one second intervals	SP is in Service mode.
Amber and then immediately blue every three seconds	System is not initialized, and no management IP address assigned.			
SP memory or boot fault LED	12	Amber	On	The SP cannot boot due to a memory or boot fault.
		—	Off	Normal Operation.

## About converged network adapter (CNA) ports

Each SP contains two integrated CNA ports (labeled 4 and 5). These ports are PCI Express 3.0 x4 adapters that provide interfaces that can be configured as Ethernet, or Fibre Channel, but once set to a protocol, cannot be changed. If CNA ports are set to Ethernet, then you can use either 1Gb/s, 10Gb/s SFPs or Twin-AX for File (IP) or iSCSI Block access. If the ports are set to Fibre Channel, then you can use SFPs supporting 4, 8, 16 Gb/s FC multi-mode, or single-mode SFPs supporting 16Gb/s only.

**NOTE:** Once you set the network protocol on the CNA ports you cannot switch to a different network protocol. Additionally, the four CNA ports cannot be configured independently; they must all be configured with the same network protocol. For example, if you configure the CNA ports for 10Gb/s Ethernet you cannot then later switch these ports to Fibre Channel.

**Table 28. CNA configurations**

Speed	Protocol	Connection
1 Gb/s	iSCSI and IP/file	BASE-T RJ45 Ethernet
10 Gb/s	iSCSI and IP/file	SFP+ or Active/Passive TwinAx
4/8/16 Gb/s	Fibre Channel <sup>1</sup>	SFP+ or OM2/OM3
4/8 Gb/s	Fibre Channel	SFP+ or OM2/OM3
16 Gb/s	Fibre Channel (Single Mode <sup>2</sup> )	SFP+ or OS1/OS2
<sup>1</sup> - You may experience performance issues when directly attaching 16Gb/s FC ports to some 16Gb/s HBAs. See the <i>Unity Family Release Notes</i> for more details.		
<sup>2</sup> - If there is a synchronous replication port, it can be configured as single mode and the remaining ports can be configured as multi mode.		

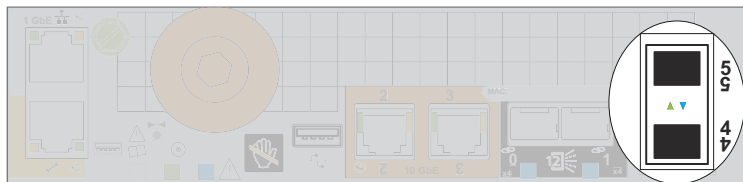

**Figure 9. CNA port locations**

## CNA port activity LED

The CNA activity port LED — a bi-color blue/green LED between the two CNA ports each connector — indicates the link/activity of the port. The port activity LED color depends on the protocol configured on the CNA.

- Fibre Channel CNA ports use a blue LED
- Ethernet CNA ports use a green LED

The following table describes the link/activity and connection speed associated with the CNA port LEDs.

**Table 29. CNA port LEDs**

LED	Color	State	Description
Link/Activity	Green	On	Ethernet link active
		Blinking (1 Hz)	Ethernet port fault
	Blue	On	Fibre Channel link active
		Blinking (1 Hz)	Fibre Channel port fault
	—	Off	Link inactive (Ethernet or FC)

## SP I/O module types

Many I/O module types are supported by the storage processor.

**NOTE:** When adding new I/O modules, always install I/O modules in pairs—one module in SP A and one module in SP B. Both SPs must have the same type of I/O modules in the same slots.

Refer to [Platform Overview](#) for a details on the supported types and the system limits of storage processor I/O modules.

- Four-port 12-Gb/s SAS I/O module -- where supported, provides four mini-HD SAS ports (x16 lane) of 12Gb SAS expansion for connecting additional DAEs. This I/O module also supports controller based encryption. Labeled 12Gb SAS v1.
- Four-port 16-Gb/s Fibre Channel I/O module -- provides Fibre Channel connectivity as listed below. Labeled 16Gb Fibre v3.
  - Four ports auto-negotiating to 4/8/16Gbps. Uses optical SFP+ and OM2/OM3 cabling to connect directly to a host HBA or FC switch.
  - One FC port negotiating to 16Gbps, which can be configured for synchronous replication between two Unity systems, either directly connected or connected through a switch. Uses optical SFP+ and SM or MM cabling to provide synchronous replication. The three remaining ports auto-negotiate to 4/8/16 Gbps, and use optical SFP+ and OM2/OM3 cabling to connect directly to a HBA or FC switch.
- Four-port 10-Gb/s optical I/O module -- provides four SFP+ optical or Active/Passive TwinAx 10GbE IP/iSCSI ports for connections to an Ethernet switch. Supports both IP(file) and iSCSI (Block) on the same I/O module. Ports can be configured as both IP and iSCSI simultaneously. Labeled 10 GbE v5.
- Four-port 10GBASE-T I/O module -- provides four copper 10GBASE-T RJ45 Ethernet ports for copper connections to an Ethernet switch. Supports both IP (file) and iSCSI (Block) on the same IO module. Ports can be configured as both IP and iSCSI simultaneously. Labeled 10GbE BaseT v2.
- Four-port 1GBASE-T I/O module -- provides four 1000BASE-T RJ-45 copper ports for Cat 5/6-cabling connections to an Ethernet switch. Supports both IP (file) and iSCSI (Block) on the same I/O module. Ports can be configured as both IP and iSCSI simultaneously. Labeled 1 GbE BaseT v3.
- Two-port 10Gb/s optical I/O module -- provides two SFP+ optical or Active/Passive TwinAx 10GbE ports for connections to an Ethernet switch. Supports both IP (file) and full iSCSI Offload engine (Block) on the same IO module. Ports can be configured as both IP and iSCSI simultaneously. Labeled 10 GbE V6.

## Detailed introduction to supported I/O modules

Overview of the supported optional I/O modules available for use in your system.

Review these sections to learn about the uses, features, ports, and LEDs for the supported optional I/O modules.

## Four-port 12-Gb/s SAS

Where supported, the four-port (x16 lane) 12-Gb/s SAS I/O module comes with four x4 lane mini-SAS HD (High Density) ports, one power/fault LED, and a combination link/activity LED for each port. Install this I/O module into the SP to provide additional SAS buses. Labeled 12Gb SAS v1.

**NOTE:** The optional back-end 12-Gb/s SAS module is not supported on all Unity storage systems.

The four-port 12-Gb/s SAS I/O module can also be configured to support x8 lane cabling for the 80-drive DAE by combining ports 0 and 1 as back-end 2, or ports 2 and 3 to create back-end 4. The I/O module can also be configured to support both x4 lane and x8 lane back-ends simultaneously.

**NOTE:** If the 12-Gb/s SAS I/O module is to be configured for x8 lane cabling, the x8 lane cable must be inserted into the I/O module before persisting it. If the x8 lane cables are not inserted into the I/O module first, all four ports default to x4 lane ports.

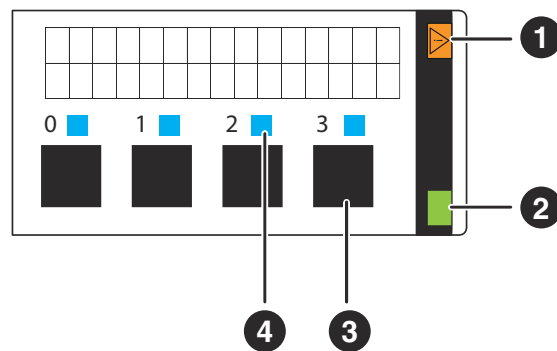

**Figure 10. Four-port 12-Gb/s SAS locations**

**Table 30. Four-port 12-Gb/s SAS location details**

Location	Description	Location	Description
1	Push button latch handle and part number label	3	12-Gb/s mini-SAS HD port
2	Power/fault LED	4	Port link/activity LED

This four-port 12-Gb/s SAS I/O module has two different types of status LEDs.

**Table 31. Four-port 12-Gb/s SAS LED descriptions**

LED	Location	Color	State	Description
Power/Fault	2	Green	On	I/O module is powered on.
		Amber	On	I/O module has faulted.
		—	Off	I/O module is powered off.
Link/activity	4	Blue	On	Network connection
		Blue	Blinking	Transmit/receive activity
		—	Off	No activity



## Four-port 16-Gb/s Fibre Channel

The four-port 16-Gb/s FC I/O module comes with four optical (fibre) ports, one power/fault LED, and a link/activity LED for each optical port. This I/O module can interface at speeds of 4, 8, and 16 Gb/s FC for host or initiator layered connections. Labeled 16Gb Fibre v3.

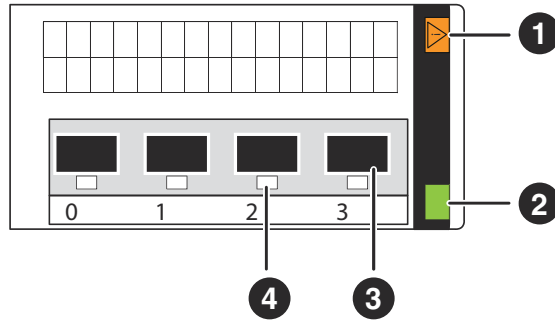

Figure 11. Four-port 16-Gb/s Fibre Channel locations

Table 32. Four-port 16-Gb/s Fibre Channel location details

Location	Description	Location	Description
1	Push button latch handle and part number label	3	16-Gb/s FC port
2	Power/fault LED	4	Port link/activity LED (blue)

This four-port 16-Gb/s FC I/O module has two different types of status LEDs.

Table 33. Four-port 16-Gb/s Fibre Channel LED descriptions

LED	Location	Color	State	Description
Power/Fault	2	Green	On	I/O module is powered on.
		Amber	On	I/O module has faulted.
		—	Off	I/O module is powered off.
Link/activity	4	Blue	On	Network connection
		Blue	Blinking	Small form-factor pluggable (SFP+) transceiver module faulted, unsupported, or optical cable fault.
		—	Off	No network connection

## Four-port 10-Gb/s optical

The four-port 10-GbE optical SFP or active/passive TwinAx I/O module with four 10-Gb/s ports, one power/fault LED, and link/activity LED for each port. This I/O module can interface at 10 Gb/s and supports both IP(file) and iSCSI (Block) on the same IO module. Ports can be configured as both IP and iSCSI simultaneously. Labeled 10 GbE v5.

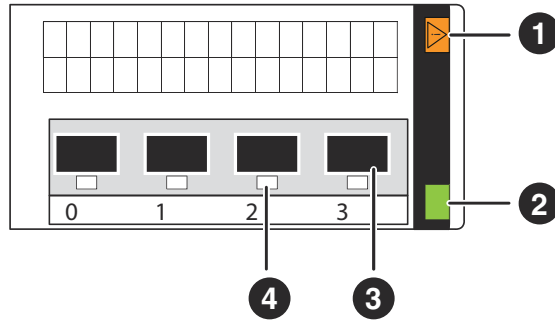

Figure 12. Four-port 10-Gb/s optical locations

Table 34. Four-port 10-Gb/s optical location details

Location	Description	Location	Description
1	Push button latch handle and part number label	3	10Gb/s optical or TwinAx Ethernet port
2	Power/fault LED	4	Port link/activity LED

This four-port 10-GbE optical SFP or active/passive TwinAx I/O module has two types of status LEDs.

Table 35. Four-port 10-Gb/s optical LED descriptions

LED	Location	Color	State	Description
Power/Fault	2	Green	On	I/O module is powered on.
		Amber	On	I/O module has faulted.
		—	Off	I/O module is powered off.
Link/activity	4	Green	On	Network connection
		Green	Blinking	Small form-factor pluggable (SFP+) transceiver module faulted, unsupported, or optical cable fault.
		—	Off	No network connection

## Four-port 10GBASE-T

The four-port 10-GbE BaseT I/O module comes with four 10-Gb/s RJ-45 ports, one power/fault LED, activity LED, and link LED for each port. This I/O module can interface at speeds of 1 Gb/s and 10 Gb/s and supports both IP(file) and iSCSI (Block) on the same IO module. Ports can be configured as both IP and iSCSI simultaneously. Labeled 10GbE BaseT v2.

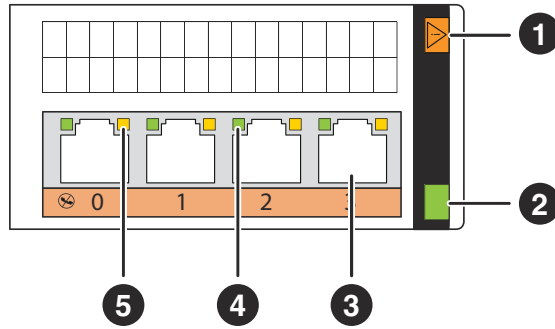

Figure 13. Four-port 10GBASE-T locations

Table 36. Four-port 10GBASE-T location details

Location	Description	Location	Description
1	Push button latch handle and part number label	4	Link
2	Power/fault LED	5	Activity
3	RJ-45 (copper) port		

This four-port 10-GbE BaseT I/O module has three types of status LEDs.

Table 37. Four-port 10GBASE-T LED descriptions

LED	Location	Color	State	Description
Power/Fault	2	Green	On	I/O module is powered on.
		Amber	On	I/O module has faulted.
		—	Off	I/O module is powered off.
Link	4	Green	On	Network connection
		—	Off	No network connection
Activity	5	Amber	Blinking	Transmit/receive activity
		—	Off	No activity

## Four-port 1GBASE-T

The four-port 1-GbE BaseT I/O module comes with four 1-Gb/s RJ-45 ports, one power/fault LED, activity LED, and link LED for each port. This I/O module can interface at speeds of 10 Mb/s, 100 Mb/s, and 1000 Mb/s. Supports both IP(file) and iSCSI (Block) on the same IO module. Ports can be configured as both IP and iSCSI simultaneously. Labeled 10GbE BaseT v2.

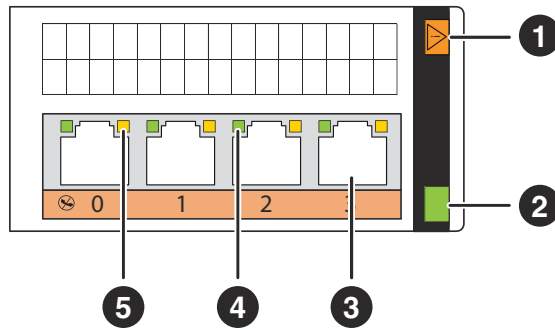

Figure 14. Four-port 1GBASE-T locations

Table 38. Four-port 1GBASE-T location details

Location	Description	Location	Description
1	Push button latch handle and part number label	4	Link
2	Power/fault LED	5	Activity
3	RJ-45 (copper) port		

This four-port 1-GbE BaseT I/O module has three types of status LEDs.

Table 39. Four-port 1GBASE-T LED descriptions

LED	Location	Color	State	Description
Power/Fault	2	Green	On	I/O module is powered on.
		Amber	On	I/O module has faulted.
		—	Off	I/O module is powered off.
Link	4	Green	On	Network connection
		—	Off	No network connection
Activity	5	Amber	Blinking	Transmit/receive activity
		—	Off	No activity

## Two-port 10Gb/s optical

The two-port 10-Gb/s optical SFP or active/passive TwinAx I/O module with two 10-Gb/s ports, one power/fault LED, and link/activity LED for each port. This I/O module can interface at 10 Gb/s and supports full iSCSI Offload. Supports both IP (file) and full iSCSI Offload (Block) on the same IO module. Ports can be configured as both IP and iSCSI simultaneously. Labeled 10 GbE V6.

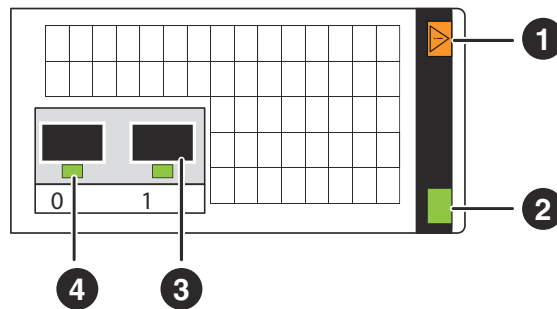

Figure 15. Two-port 10Gb/s optical locations

Table 40. Two-port 10Gb/s optical location details

Location	Description	Location	Description
1	Push button latch handle and part number label	3	10-Gb/s optical SFP or active TwinAx port
2	Power/fault LED	4	Port link/activity LED

This two-port 10-Gb/s optical SFP or active/passive TwinAx I/O module has two types of status LEDs.

Table 41. Two-port 10Gb/s optical LED descriptions

LED	Location	Color	State	Description
Power/Fault	2	Green	On	I/O module is powered on.
		Amber	On	I/O module has faulted.
		—	Off	I/O module is powered off.
Link/activity	4	Green	On	Network connection
		Green	Blinking	Small form-factor pluggable (SFP+) transceiver module faulted, unsupported, or optical cable fault.
		—	Off	No network connection

## Small form-factor pluggable (SFP) transceiver modules

Certain I/O modules use a small form-factor pluggable plus (SFP+) transceiver module for cable connections. The SFP+ transceiver modules connect to Lucent Connector (LC) type interface (see [Lucent Connector type interface](#) for more information) optical fibre cables. These SFP+ transceiver modules are input/output (I/O) devices. These SFP+ modules are hot swappable. This means that you can install and remove an SFP+ module while the component is operating.

[Example of an SFP+ module](#) shows an example of an SFP+ module.

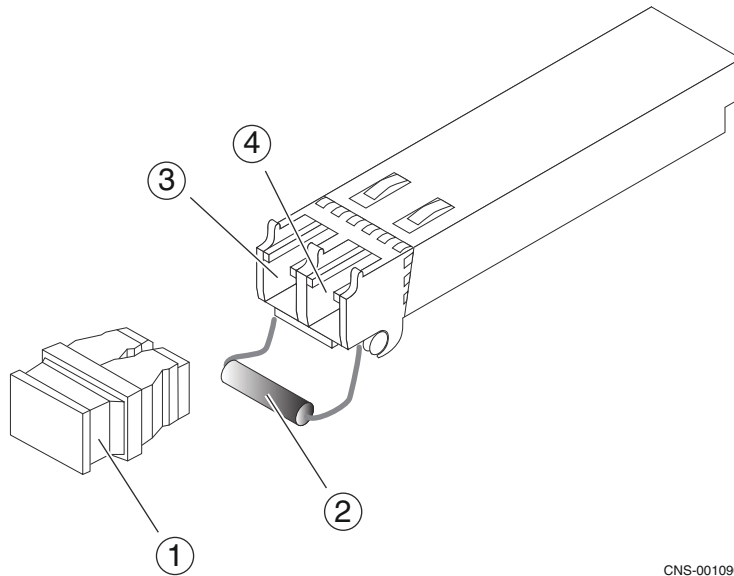

CNS-001090

**Figure 16. Example of an SFP+ module**

**Table 42. SFP+ module descriptions**

Location	Description
1	Dust plug (protective cap)
2	Bale clasp latch
3	Send or transmit (TX) optical bore
4	Receive (RX) optical bore

## Lucent Connector type interface

The Lucent Connector (LC) type interface was developed by Lucent Technologies (hence, Lucent Connector). It uses a push-pull mechanism. LC connectors are normally held together in a multimode duplex configuration with a plastic clip.

These cables are usually colored orange for OM2 multimode optical fiber type cables, aqua for OM3 multimode optical fiber type cables, and yellow for single mode optical fiber type cables. The multimode cables have the duplex connectors encased in a gray plastic covering. The single mode cables are encased in a blue plastic covering.

To determine the send or transmit (TX) and receive (RX) ferrules (connector ends), these cables will show a letter and numeral (for example A1 and A2 for the TX and RX, respectively) or a white and yellow rubber gasket (jacket) for the send or transmit (TX) and receive (RX) ends. [Example of LC-type connectors](#) shows an example of LC-type connectors.

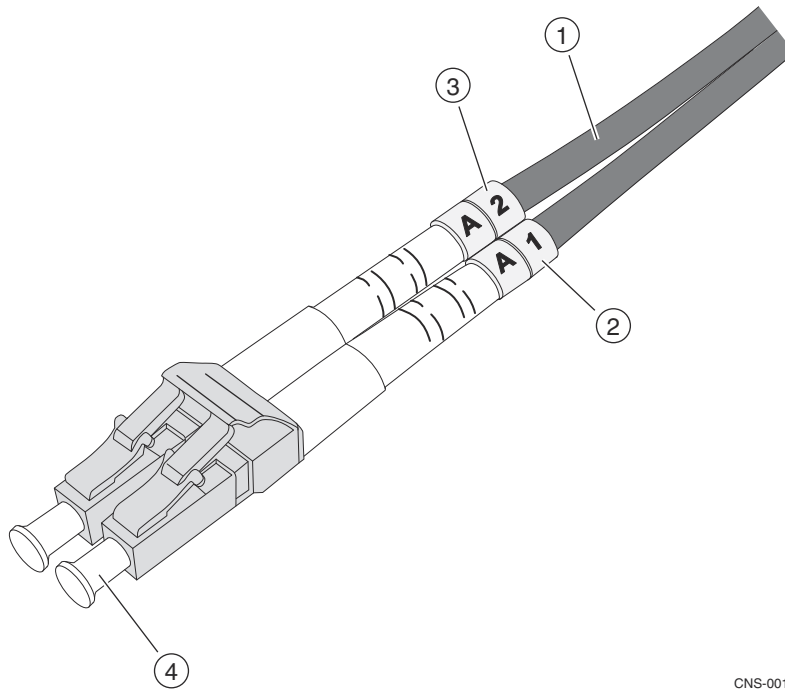

CNS-001102

Figure 17. Example of LC-type connectors

Table 43. LC-type connector details

Location	Description
1	Cable
2	Rubber gasket (jacket), send or transmit (TX)
3	Rubber gasket (jacket), receive (RX)
4	Ferrule (connector end to SFP+ module)

## SP power supply module

SP latch, power supply (power in) recessed connector (plug), and status LEDs shows the SP power supply module. Each power supply includes three LEDs (AC, DC, and fault). A latch on the module locks it into place to ensure proper connection.

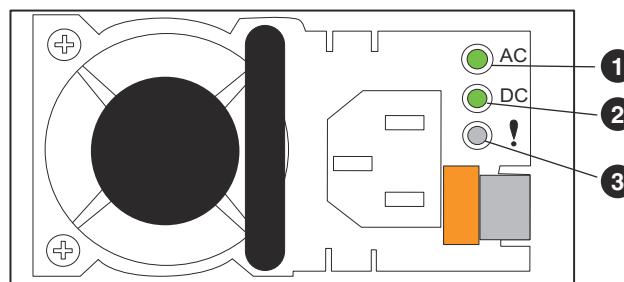

Figure 18. SP latch, power supply (power in) recessed connector (plug), and status LEDs

**NOTE:** The power supply used in your storage system must meet the storage system power requirements and must be the same type of power supply to be used in both SPs (SP A and B). You cannot mix power supply types.

SP power supply (fault and power on) LEDs describes the power supply (fault and power on) LEDs.

**Table 44. SP power supply (fault and power on) LEDs**

LED	Location	Color	State	Description
AC power (input)	❶	Green	On	AC Power on
		—	Off	AC Power off, verify source power
DC power (output)	❷	Green	On	DC Power on
		—	Off	DC Power off, verify source power
Fault	❸	Amber	On	Power supply or backup fault, check cable connection
			Blinking	BIOS, POST and OS booting up or system overheating
		—	Off	No fault or power off

## Storage processor internal components

Included within the SP are the following replaceable components:

- Memory modules
- Battery backup unit (BBU)
- SSD internal disk
- Cooling modules (5)

**Memory modules** Four memory module slots reside on the SP printed circuit board (motherboard) within the SP. Depending on the model, three or four of these DIMM slots will be populated with 8 GB, 16 GB, or 32 GB DIMMs. DIMMs used in Unity systems support error-correcting code (ECC) memory.

**Batter backup unit (BBU)** The SP includes a Lithium-ion (Li-ion) internal battery or BBU that powers the associated SP module during a power event.

**SSD internal disk** Each SP has an internal disk on at top side of the SP motherboard and is located adjacent to cooling module 4.

**Cooling modules** Five redundant cooling modules connect to the motherboard within the SP to provide continuous airflow through the front disks and through the rear SP to keep the DPE components at optimal operating temperatures. Within each SP assembly are two adaptive cooling zones managed by the five internal cooling modules. Cooling modules 0-2 direct airflow through zone 1 and cooling modules 3 and 4 direct airflow though zone 2.

 **NOTE:** An SP will perform a protective thermal shutdown if two cooling modules fault within the same SP.



# Disk-array enclosures

This section describes and illustrates the front- and rear-panel controls, ports, and LED indicators on the supported disk-array enclosures (DAEs).

## Topics:

- [General information on front-loading DAEs](#)
- [2U, 25 \(2.5-inch\) DAE](#)
- [3U, 15 \(3.5-inch\) DAE](#)
- [General information on drawer-type DAEs](#)
- [3U, 80 \(2.5-inch\) DAE](#)

## General information on front-loading DAEs

Each DAE with front facing drives typically consists of the following components:

- Drive carrier
- Disk drive
- Midplane
- Link control cards (LCCs)
- Power supply/cooling modules
- EMI shielding

### Drive carrier

The disk drive carriers are metal and plastic assemblies that provide smooth, reliable contact with the enclosure slot guides and midplane connectors. Each carrier has a handle with a latch and spring clips. The latch holds the disk drive in place to ensure proper connection with the midplane. Disk drive activity/fault LEDs are integrated into the carrier.

### Disk drives

Each disk drive consists of one disk drive in a carrier. You can visually distinguish between disk drive types by their different latch and handle mechanisms and by type, capacity, and speed labels on each disk drive. You can add or remove a disk drive while the DAE is powered up, but you should exercise special care when removing disk drives while they are in use. Disk drives are extremely sensitive electronic components.

### Midplane

A midplane separates the front-facing disk drives from the rear-facing LCCs and power supply/cooling modules. It distributes power and signals to all components in the enclosure. LCCs, power supply/cooling modules, and disk drives plug directly into the midplane.

### Link control cards (LCCs)

An LCC supports, controls, and monitors the DAE, and is the primary interconnect management element. Each LCC includes connectors for input and expansion to downstream devices. An enclosure address (EA) indicator is located on each LCC. Each LCC also includes a bus (loop) identification indicator.

## Power supply/cooling modules

The power supply/cooling module integrates independent power supply and blower cooling assemblies into a single module.

Each power supply is an auto-ranging power-factor-corrected, multi-output, off-line converter with its own line cord. The drives and LCC have individual soft-start switches that protect the disk drives and LCC if you install them while the disk enclosure is powered up. A disk or blower with power-related faults will not affect the operation of any other device.

Each power/cooling module has three status LEDs.

## EMI shielding

EMI compliance requires a properly installed electromagnetic interference (EMI) shield in front of the DAE disk drives. When installed in cabinets that include a front door, the DAE includes a simple EMI shield. Other installations require a front bezel that has a locking latch and integrated EMI shield. You must remove the bezel/shield to remove and install the disk drive modules.

## Disk drive type

Serial Attached SCSI (SAS) and Flash (solid state disk drives with flash memory, or SSD) disk drives are 12-volt, and support the SAS interface. Firmware and drive carriers are unique to Dell.

## 2U, 25 (2.5-inch) DAE

The 25 (2.5-inch) disk drive DAE is 2 rack units (U), 3.40 inches, high and includes slots for 25 2.5-inch disk drives. It uses a 12-Gb/s SAS interface for communication between the storage processors (SPs) and the DAE.

Review the following sections for details on the components and LEDs comprising this DAE.

### 2U, 25-drive DAE front view

On the front, the 2U, 25 disk drive DAE includes the following components:

- Disk drives in 2.5-inch carriers (hot-swappable)
- Status LEDs

Example of a 2U, 25 (2.5-inch) disk drive DAE (front view) shows the location of these components.

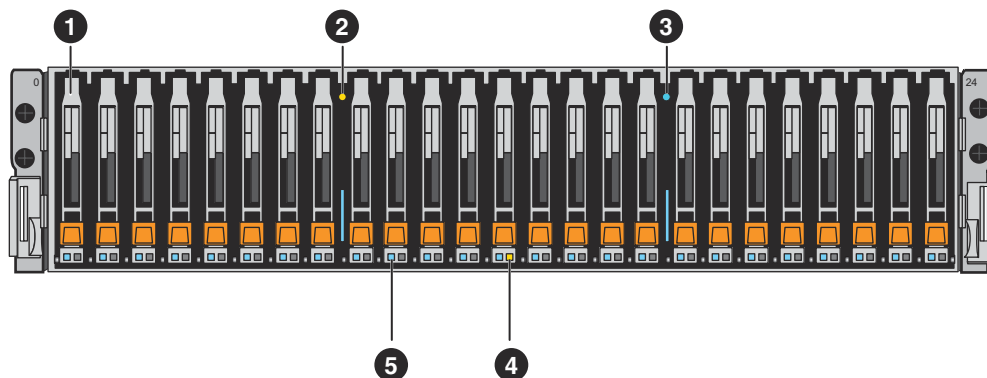

Figure 19. Example of a 2U, 25 (2.5-inch) disk drive DAE (front view)

Table 45. 2U, 25-drive DAE descriptions

Location	Description	Location	Description
1	2.5-inch 6-Gb/s SAS drives	4	Disk drive fault LED (amber)
2	DAE fault LED (amber)	5	Disk drive status/activity (blue)

**Table 45. 2U, 25-drive DAE descriptions (continued)**

Location	Description	Location	Description
3	DAE power status LED (blue)		

2U, 25-drive DAE and disk drive status LEDs describes the 2U, 25 (2.5-inch) DAE and disk drive status LEDs.

**Table 46. 2U, 25-drive DAE and disk drive status LEDs**

LED	Location	Color	State	Description
DAE fault	2	Blue	On	No fault has occurred
		Amber	On	Fault has occurred
DAE power	3	Blue	On	Powering and powered up
		—	Off	Powered down
Disk drive fault	4	Amber	On	Fault has occurred
		—	Off	No fault has occurred
Disk drive on/activity	5	Blue	On	Powering and powered up
			Blinking	Disk drive activity

## 2U, 25 (2.5-inch) rear view

On the rear of a 2U, 25 (2.5-inch) DAE are the following components:

- Two 12-Gb/s SAS link control cards (LCC); A (4) and B (2)
- Two power supply/cooling modules; A (3) and B (1)

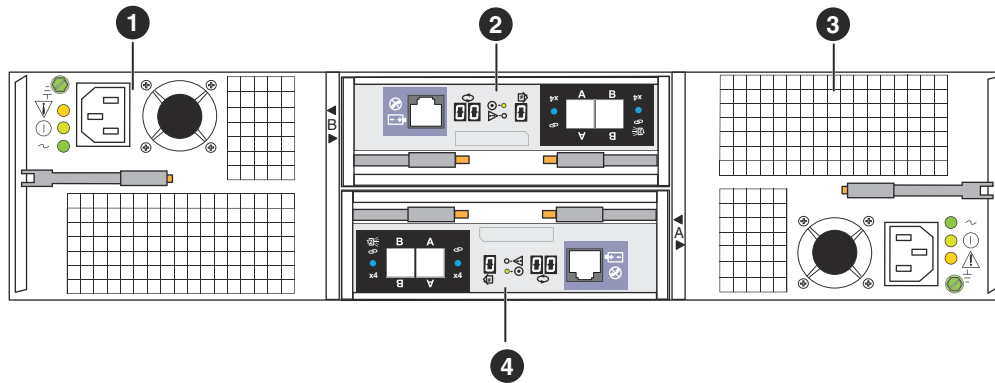

**Figure 20. 2U, 25-drive DAE rear component locations**

## 2U, 25-drive DAE LCC

### LCC functions and features

The LCC supports, controls, and monitors the DAE, and is the primary interconnect management element. Each LCC includes connectors for input and output to downstream devices.

The LCCs in a DAE connects to the storage processors and other DAEs. The cables connect the LCCs in a system in a daisy-chain topology.

Internally, each DAE LCC uses protocols to emulate a loop; it connects to the drives in its enclosure in a point-to-point fashion through a switch. The LCC independently receives and electrically terminates incoming signals. For traffic from the system's storage processors, the LCC switch passes the signal from the input port to the drive being accessed; the switch then forwards the drive output signal to the port.

Each LCC independently monitors the environmental status of the entire enclosure, using a microcomputer-controlled monitor program. The monitor communicates the status to the storage processor, which polls disk enclosure status. LCC firmware also controls the SAS Phys and the disk-module status LEDs.

An enclosure ID, sometimes referred to as the enclosure address (EA), indicator is located on each LCC. Each LCC also includes a bus (back-end port) identification indicator. The SP initializes the bus ID when the operating system is loaded.

### 12-Gb/s LCC ports, LEDs, and connectors

Each 3U, 15 (3.5-inch) DAE LCC shows the following ports, LEDs, and connectors:

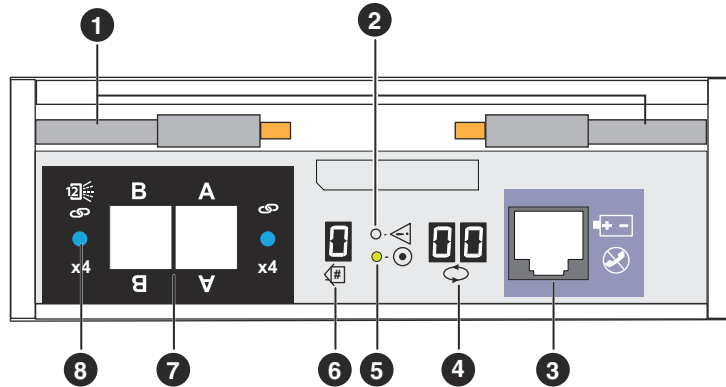

Figure 21. 2U, 25-drive DAE LCC ports, LEDs, and connectors

Table 47. 2U, 25 (2.5-inch) DAE LCC descriptions

Location	Description	Location	Description
1	Ejector latch handles	5	LCC power LED
2	LCC fault LED	6	Enclosure ID display
3	LCC management port (RJ-12) (not used)	7	12-Gb/s SAS ports
4	Back-end (BE) bus ID display	8	SAS port status LED

Table 48. 12-Gb/s LCC LEDs

LED	Location	Color	State	Description
LCC fault LED	2	Amber	On	Fault within the LCC
		—	Off	No fault or powered off
LCC power LED	5	Blue	On	Powered on and no fault
		—	Off	Powered off
SAS port status LED	8	Amber	On	SAS port faulted
		Blue	On	SAS port linked up
		—	Off	No connector in port

## 2U, 25-drive DAE power supply and cooling module

### Power supply and cooling module functions and features

The power supply/cooling modules are located to the left and right of the LCCs. The units integrate independent power supply and two dual-blower cooling assemblies into a single module.

Each power supply is an auto-ranging, power-factor-corrected, multi-output, offline converter with its own line cord. Each supply supports a fully configured DAE and shares load currents with the other supply. The drives and LCCs have individual soft-start switches that protect the disk drives and LCCs if they are installed while the disk enclosure is powered up. The enclosure cooling system includes two dual-blower modules.

### Power supply and cooling module connectors and LEDs

2U, 25-drive DAE AC power supply and cooling module shows an example of a 2U, 25-drive DAE AC power supply/cooling module with a power in (recessed) connector (plug) and status LEDs.

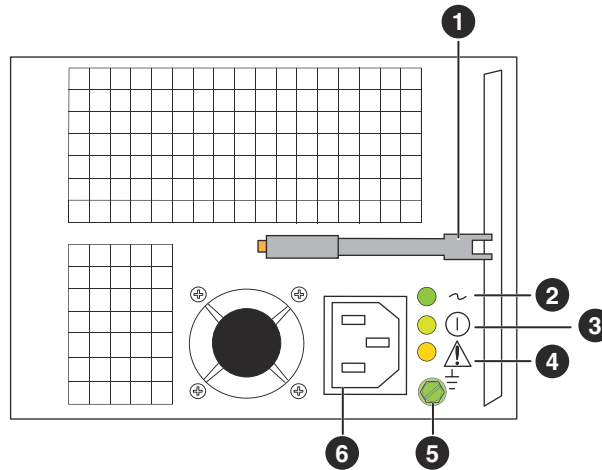

Figure 22. 2U, 25-drive DAE AC power supply and cooling module

Table 49. 2U, 25 (2.5-inch) DAE descriptions

Location	Description	Location	Description
1	Ejector latch handle	4	Power supply/cooling module fault LED
2	AC power LED (input)	5	Grounding screw
3	DC power LED (output)	6	LCC B AC power supply power in (recessed plug)

Table 50. 2U, 25-drive DAE AC power supply/cooling module LEDs

LED	Location	Color	State	Description
AC power LED (input)	2	Green	On	AC power on
			Off	AC power off, verify source power
DC power LED (output)	3	Green	On	DC power on
			Off	DC power off, verify source power
Power supply/cooling module fault LED	4	Amber	On	Fault
			Blinking	During power shutdown and during overvoltage (OVP) and undervoltage protection (UVP) fault
			Off	No fault or power off

## 3U, 15 (3.5-inch) DAE

The 15 (3.5-inch) disk drive DAE is 3 rack units (U), 5.25 inches, high and includes slots for 15 3.5-inch disk drives. It uses a 12-Gb/s SAS interface for communication between the storage processors (SPs) and the DAE.

Review the following sections for details on the components and LEDs comprising this DAE.

## 3U, 15-drive DAE Front view

On the front, the 3U, 15 disk drive DAE includes the following components:

- Disk drives in 3.5-inch carriers (hot-swappable)
- Status LEDs

Example of a 3U, 15 disk drive DAE (front view) shows the location of these components.

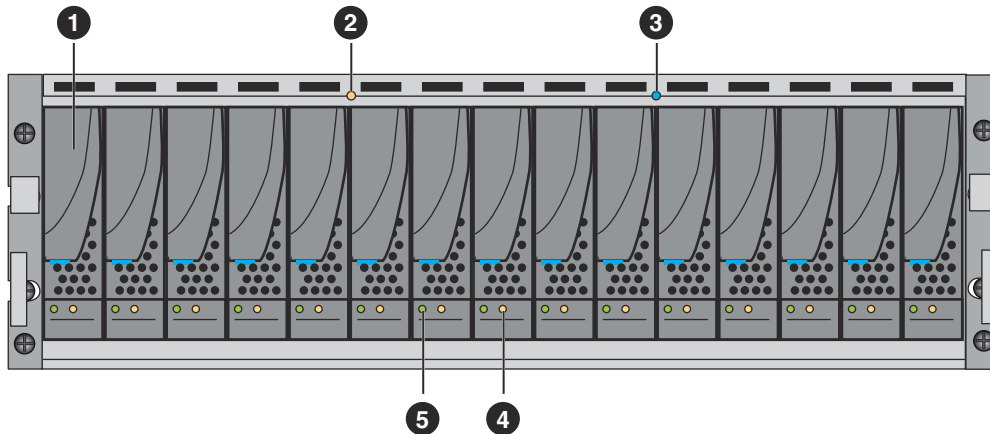

Figure 23. Example of a 3U, 15 disk drive DAE (front view)

Table 51. 3U, 15-drive DAE descriptions

Location	Description	Location	Description
1	3.5-inch disk drive carriers that hold 2.5- or 3.5-inch disk drives	4	Disk drive fault LED
2	DAE fault LED	5	Disk drive on/activity LED
3	DAE power on LED		

3U, 15 disk drive DAE and disk drive LEDs describes the 2U, 25 (2.5-inch) DAE and disk drive status LEDs.

Table 52. 3U, 15 disk drive DAE and disk drive LEDs

LED	Location	Color	State	Description
DAE fault	2	Amber	On	Fault has occurred within DAE
DAE power	3	—	On	Enclosure power on (main voltage)
			Off	Enclosure power off
Disk drive fault	4	Amber	On	Fault has occurred
			Off	No fault has occurred
Disk drive on/activity	5	Blue	On	Powering and powered up
			Blinking	Disk drive activity
			Off	Powered down

## 3U, 15-drive DAE rear view

On the rear, the 3U, 15-drive DAE includes the following components:

- Two 12-Gb/s SAS link control cards (LCC); A (3) and B (1)
- Two power supply/cooling modules; A (4) and B (2)

The 3U, 15-drive DAE rear components are redundantly distributed across two sides, A and B. When viewed from behind, the top two components make up the B-side of the DAE, and the bottom two components make up the A-side.

[3U, 15-drive DAE rear component locations](#) shows an example of the rear view of a 3U, 15-drive DAE.

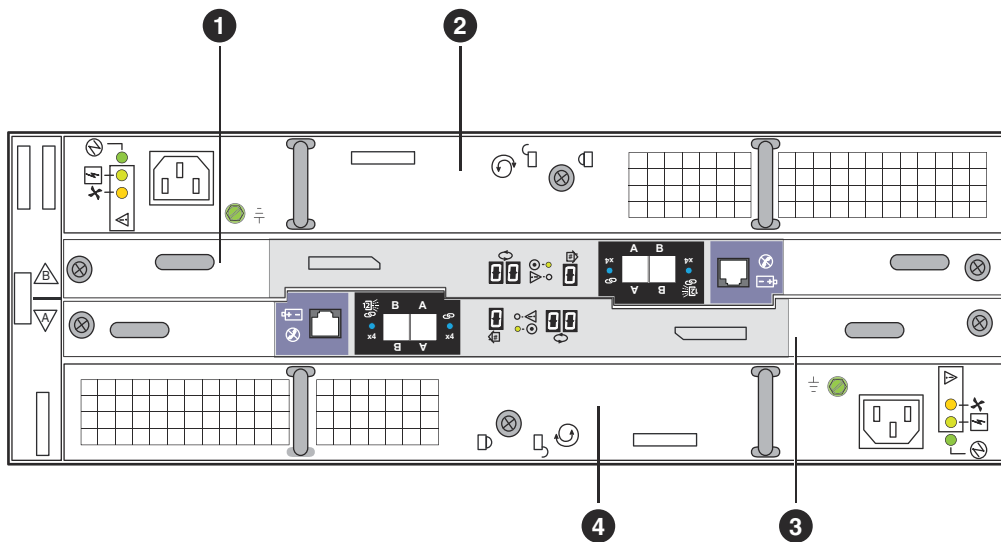

**Figure 24. 3U, 15-drive DAE rear component locations**

## 3U, 15-drive DAE LCC

### Link control card functions and features

The LCC supports, controls, and monitors the DAE, and is the primary interconnect management element. Each LCC includes connectors for input and output to downstream devices.

The LCCs in a DAE connects to the storage processors and other DAEs. The cables connect the LCCs in a system in a daisy-chain topology.

Internally, each DAE LCC uses protocols to emulate a loop; it connects to the drives in its enclosure in a point-to-point fashion through a switch. The LCC independently receives and electrically terminates incoming signals. For traffic from the system's storage processors, the LCC switch passes the signal from the input port to the drive being accessed; the switch then forwards the drive output signal to the port.

Each LCC independently monitors the environmental status of the entire enclosure, using a microcomputer-controlled monitor program. The monitor communicates the status to the storage processor, which polls disk enclosure status. LCC firmware also controls the SAS Phys and the disk-module status LEDs.

An enclosure ID, sometimes referred to as the enclosure address (EA), indicator is located on each LCC. Each LCC also includes a bus (back-end port) identification indicator. The SP initializes the bus ID when the operating system is loaded.

### 3U, 15-drive DAE LCC connectors and LEDs

Each 3U, 15 (3.5-inch) DAE LCC shows the following ports, LEDs, and connectors:

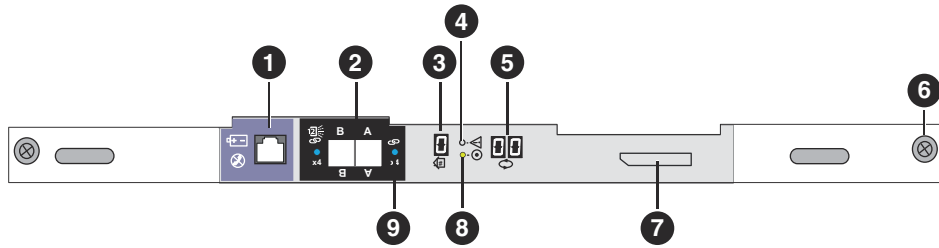

Figure 25. 12-Gb/s LCC ports, LEDs, and connectors

Table 53. 12-Gb/s LCC ports, LEDs, and connectors

Location	Description	Location	Description
1	LCC management port (RJ-12) (not used)	6	Captive screw
2	12-Gb/s SAS ports	7	Part number label
3	Enclosure ID display	8	LCC power LED
4	LCC fault LED	9	SAS port status LED
5	Back-end (BE) bus ID display		

Review [3U 15 disk drive DAE AC power supply/cooling module LEDs](#) for the LED descriptions and status meanings.

Table 54. 12-Gb/s LCC LEDs

LED	Location	Color	State	Description
LCC fault LED	4	Amber	On	Fault within the LCC
		—	Off	No fault or powered off
LCC power LED	8	Blue	On	Powered on and no fault
		—	Off	Powered off
SAS port status LED	9	Amber	On	SAS port faulted
		Blue	On	SAS port linked up
		—	Off	No connector in port

## 3U, 15-drive DAE power supply and cooling module

### Power supply and cooling module functions and features

The power supply/cooling modules are located above and below the LCCs. The units integrate independent power supply and dual-blower cooling assemblies into a single module.

Each power supply is an auto-ranging, power-factor-corrected, multi-output, offline converter with its own line cord. Each supply supports a fully configured DAE and shares load currents with the other supply. The drives and LCCs have individual soft-start switches that protect the disk drives and LCCs if they are installed while the disk enclosure is powered up. The enclosure cooling system includes two dual-blower modules.



## Power supply and cooling module connectors and LEDs

3U, 15-drive DAE power supply and cooling module shows an example of the 3U 15 (3.5 inch) disk drive DAE AC power supply/cooling module with a power in (recessed) connector (plug) and status LEDs.

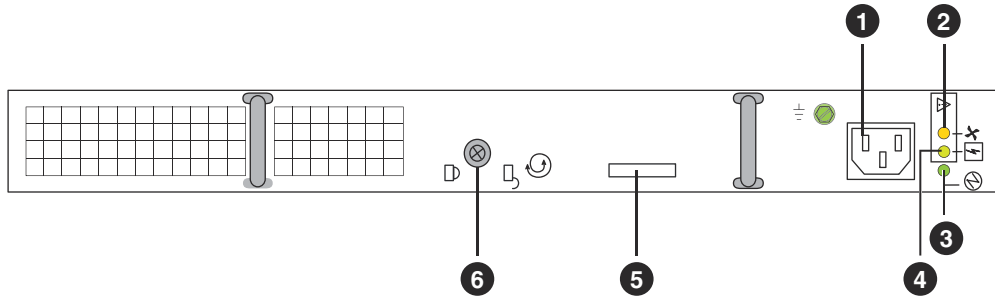

Figure 26. 3U, 15-drive DAE power supply and cooling module

Table 55. 3U 15 disk drive DAE AC power supply/cooling module

Location	Description	Location	Description
1	AC power in (recessed plug) connector	4	Power supply fault LED
2	Cooling fault LED	5	Part number label
3	Power supply on LED	6	Captive screw

Review 3U 15 disk drive DAE AC power supply/cooling module LEDs for the LED descriptions and status meanings.

Table 56. 3U 15 disk drive DAE AC power supply/cooling module LEDs

LED	Location	Color	State	Description
Cooling fault	2	Amber	On	Fault, one or both blowers not operating normally
		—	Off	No fault, blowers operating normally
Power supply on	3	Green	On	Power on
		—	Off	Power off
Power supply fault	4	Amber	On	Fault
			Blinking	During power shutdown and during overvoltage and undervoltage protection (OVP/UVF) fault
		—	Off	No fault or power off

## General information on drawer-type DAEs

Each DAE with internal drives typically consists of the following components:

- Drive carrier
- Disk drive
- Link control cards (LCCs)
- Power supply
- Cooling modules
- EMI shielding
- Cable management arms

## Drive carrier

The disk drive carriers are metal and plastic assemblies that provide smooth, reliable contact with the enclosure slot guides and midplane connectors. Each carrier has a handle with a latch and spring clips. The latch holds the disk drive in place to ensure proper connection with the midplane. Disk drive activity/fault LEDs are integrated into the carrier.

## Disk drives

Each disk drive consists of one disk drive in a carrier. You can visually distinguish between disk drive types by their different latch and handle mechanisms and by type, capacity, and speed labels on each disk drive. You can add or remove a disk drive while the DAE is powered up, but you should exercise special care when removing disk drives while they are in use. Disk drives are extremely sensitive electronic components.

## Link control cards (LCCs)

An LCC supports, controls, and monitors the DAE, and is the primary interconnect management element. Each LCC includes connectors for input and expansion to downstream devices. An enclosure address (EA) indicator and bus (loop) identification indicator is located on one LCC of each DAE.

## Power supply

The power supplies and cooling modules or fans are separated. The power supplies are located on the rear. The power supply module has an orange knob used for removing and installing the power supply module from the DAE .

## Cooling modules (Fans)

The cooling modules or fans are separate from the power supply modules. The cooling modules or fans are located on the front and middle of the drawer-type DAEs, depending on DAE type. The cooling modules or fans can only be installed/removed by sliding the DAE forward. You access the cooling modules or fans from inside the DAE.

## EMI shielding

EMI compliance requires a properly installed electromagnetic interference (EMI) shield in front of the DAE disk drives. When installed in cabinets that include a front door, the DAE includes a simple EMI shield. Other installations require a front bezel that has a locking latch and integrated EMI shield. You must remove the bezel/shield to remove and install the disk drive modules.

## Cable management arms

Locking Scissor-type cable management arms attach to the rear of the drawer-type DAEs to provide easy cable management for the power cords and SAS cables that attach to the rear ports of the DAE. The cable management arms extend to an open position when the unlocked DAE is pulled forward in the cabinet and retract to a closed position when the DAE is pushed back into the cabinet.

## 3U, 80 (2.5-inch) DAE

The 80 (2.5-inch) disk drive DAE is 3 rack units (U), 3.4 inches (8.64 cm) high, and includes slots for 80 2.5-inch disk drives. It uses a 12-Gb/s SAS interface for communication between the storage processors (SPs) and the DAE.

Review the following sections for details on the components and LEDs comprising this DAE.

# 3U, 80-drive DAE top view

## Component overview

The 3U, 80-drive DAE includes the following internal components:

- Disk drives in 2.5-inch carriers (hot-swappable) (1)
- 10 redundant cooling modules
  - Five in the front of the system, labeled 0-4 (2)
  - Five at the rear of the system, labeled 5-9 (3)

The disk drive slots and cooling modules on an 80-drive DAE are located inside the enclosure. To access the disk drives, release and pull the enclosure out of the cabinet. The enclosure slides out of the cabinet far enough for you to access its internal components, and then locks on the rails in the service position so that you cannot pull it out any farther.

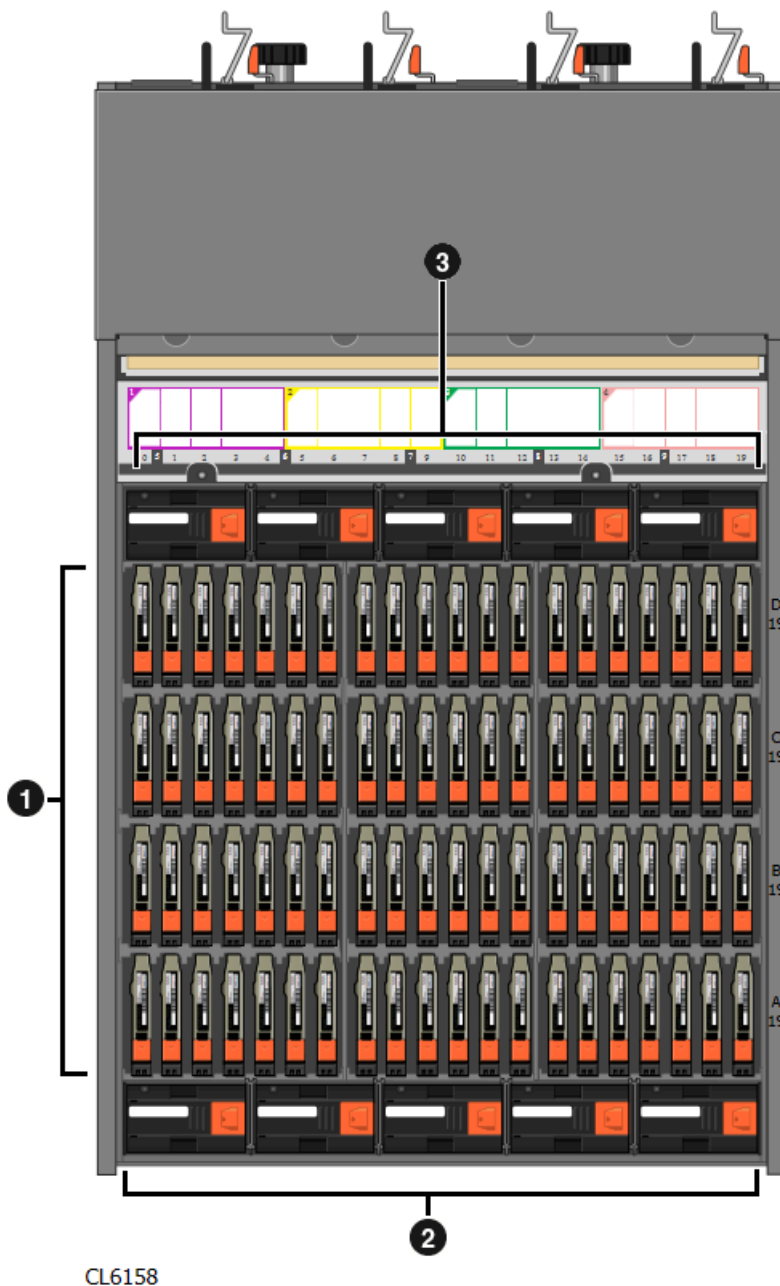

Figure 27. 3U, 80-drive DAE internal component locations (top view)

## Disk drive LEDs

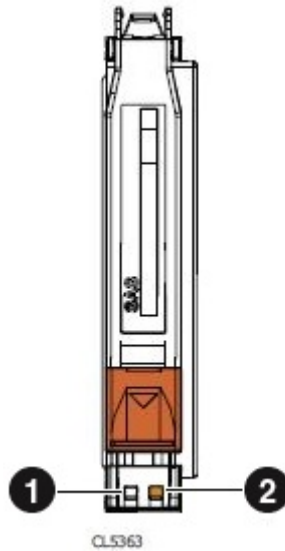

Figure 28. 2.5 inch disk drive LEDs

LED	Location	Color	State	Description
Disk drive on/activity	1	Blue	On	Powering and powered up
			Blinking	Disk drive activity
Disk drive fault	2	Amber	On	Fault has occurred
		-	Off	No fault has occurred

## Cooling module LEDs

Cooling modules contain only one LED, to indicate that the part has faulted.

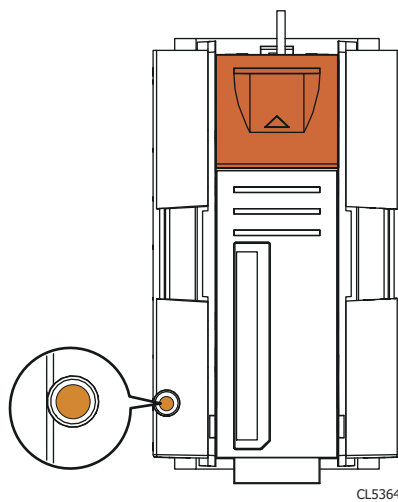

Figure 29. Cooling module fault LED location

## 3U, 80-drive DAE front view

There is only one component accessible from the front of the 3U 80-drive DAE, the system status card (SSC).

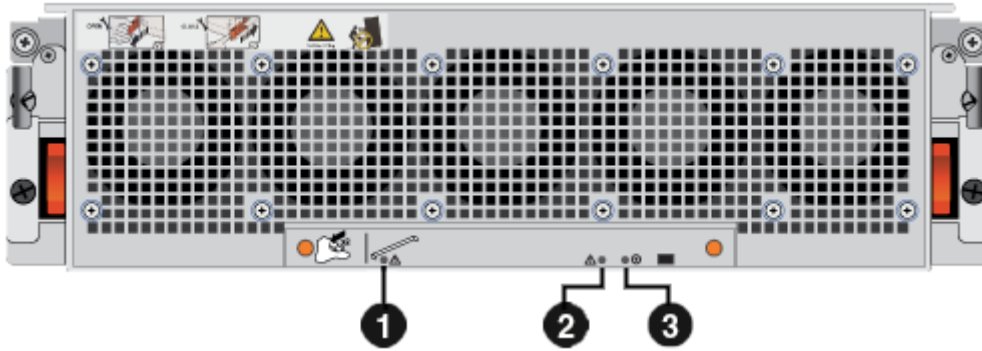

Figure 30. 3U 80-drive DAE system status card location

Table 57. System status card status LEDs

LED	Location	Color	State	Description
System status card fault LED	1	Amber	On	Fault within the system status card
		-	Off	No fault
System fault LED	2	Amber	On	Component within the system (disk, fan LCC, power supply) has faulted
		-	Off	No fault
System status card power LED	3	Blue	On	Powered on and no fault
		-	Off	Powered off

### 3U, 80-drive DAE rear view

The following components are accessible from the rear of the 3U, 80-drive DAE:

- Two 12-Gb/s SAS link control cards (LCC); A (2) and B (1)
- Four power supplies (3)

The 3U, 80-drive DAE rear components are redundantly distributed across two sides, A and B. When viewed from behind, the right half of the system makes up the A-side of the DAE, and the left half of the system makes up the B-side.

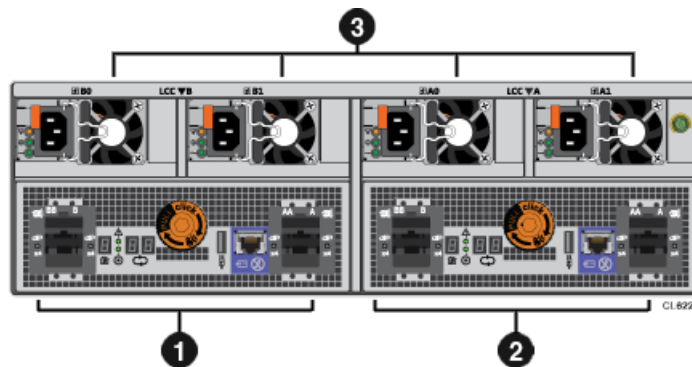

Figure 31. 3U, 80-drive DAE rear component locations

## 3U, 80-drive DAE LCC

### Link control card functions and features

The LCC supports, controls, and monitors the DAE, and is the primary interconnect management element. Each LCC includes connectors for input and output to downstream devices.

The LCCs in a DAE connect to the storage processors and other DAEs. The cables connect the LCCs in a system in a daisy chain topology.

Internally, each DAE LCC uses protocols to emulate a loop; it connects to the drives in its enclosure in a point-to-point fashion through a switch. The LCC independently receives and electrically terminates incoming signals. For traffic from the system's storage processors, the LCC switch passes the signal from the input port to the drive being accessed; the switch then forwards the drive output signal to the port.

Each LCC has four ports marked AA/A and BB/B. The A and B ports are used when connecting (A) or expanding (B) using x4 lane cables. The AA/A and BB/B ports are both used when connecting (AA/A) or expanding (BB/B) using x8 lane cabling.

Each LCC independently monitors the environmental status of the entire enclosure, using a microcomputer-controlled monitor program. The monitor communicates the status to the storage processor, which polls disk enclosure status. LCC firmware also controls the SAS Phys and the disk-module status LEDs.

An enclosure ID, sometimes referred to as the enclosure address (EA), indicator is located on each LCC. Each LCC also includes a bus (back-end port) identification indicator. The SP initializes the bus ID when the operating system is loaded.

**NOTE:** Some LCCs may not have the enclosure ID display (3) or back-end bus display (6). These LCCs are functionally identical to LCCs with the enclosure ID display and back-end bus display. LCCs with displays always replace LCCs without displays.

### 3U, 80-drive DAE LCC connectors and LEDs

Each 3U, 80-drive DAE LCC contains the following ports, LEDs, and connectors:

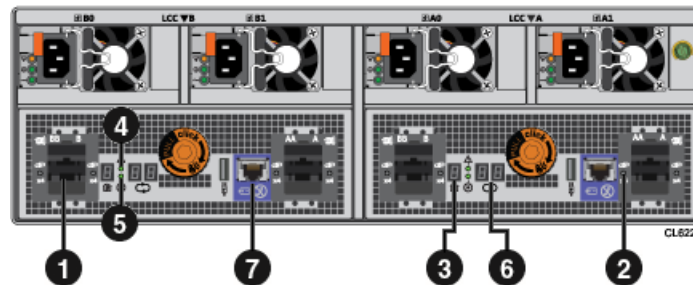

Figure 32. 12-Gb/s LCC ports, LEDs and connectors

Table 58. 12-Gb/s LCC ports, LEDs and connectors

Location	Description
1	12-Gb/s mini SAS ports
2	Mini SAS port status LED
3	Enclosure ID display <sup>a</sup>
4	LCC fault LED
5	LCC power LED
6	Back-end (BE) bus ID display <sup>a</sup>
7	LCC management port (RJ-12) (not used)

**Table 58. 12-Gb/s LCC ports, LEDs and connectors (continued)**

a. May not be included on all LCCs.

**Table 59. 12 Gb/s LCC LEDs**

LED	Location	Color	State	Description
Mini SAS port status LED	2	Blue	On	SAS port linked up
		Green	On	Powered on
		-	Off	No connector in port
LCC fault LED	4	Amber	On	Fault within the LCC
		-	Off	No fault or powered off
LCC power LED	5	Green	On	Powered on and no fault
		-	Off	Powered off

### 3U, 80-drive DAE power supply

#### Power supply functions and features

The power supplies are located above the LCCs.

Each power supply is an auto-ranging, power-factor-corrected, multi-output, offline converter with its own line cord. Each supply supports a fully configured DAE and shares load currents with the other supply. The drives and LCCs have individual soft-start switches that protect the disk drives and LCCs if they are installed while the disk enclosure is powered up.

#### Power supply components and LEDs

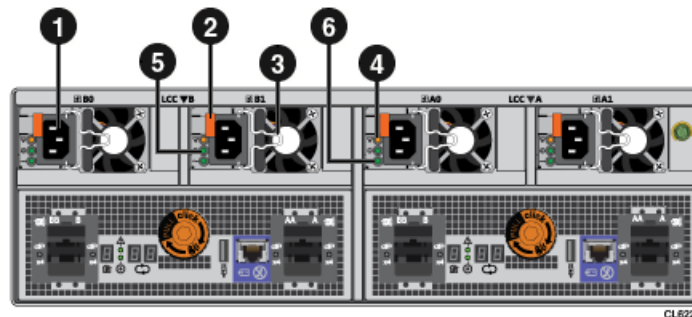

**Figure 33. 3U, 80-drive DAE power supply components and LEDs**

**Table 60. 3U, 80-drive DAE power supply components and LEDs**

Location	Description
1	AC power in (recessed plug) connector
2	Release lever
3	Retaining ball
4	Power supply fault LED
5	AC output LED
6	AC input LED

**Table 61. 3U, 80-drive DAE power supply LEDs**

LED	Location	Color	State	Description
Power supply fault	④	Amber	On	Fault
		-	Off	No fault or power off
AC power LED (input)	⑤	Green	On	Power on
		-	Off	Power off, verify source power
AC output LED	⑥	Green	On	Power on
		-	Off	Power off, verify source power



# Cabling

This section describes examples of the types of cabling you will need to connect the DAEs to your system. The descriptions are presented in illustrations and text. Each illustration shows an example of the cable connection points (ports) located on the specific hardware component.

**NOTE:** The following sections only discuss the DAE cabling with the customer installable front-loading DAEs.

For all other cabling of your system, its installation guide provides information about the system power cabling, DAE power cabling, PDU power cabling, LAN cabling, and so on.

## Topics:

- [Cable label wraps](#)
- [Cabling the DPE to a DAE](#)
- [Cabling an expansion DAE to an existing DAE to extend a back-end bus](#)
- [12Gb/s SAS cabling for interleaved DAE configurations](#)
- [12Gb/s SAS cabling for stacked DAE configurations](#)
- [Attaching expansion \(back-end\) cables to an 80-drive DAE](#)

## Cable label wraps

Each system comes with a cable label wrap guide or set of cable label wraps to affix to the cables. These labels should be affixed to the appropriate cables as you connect the cables.

**NOTE:** If your system was assembled at the factory, all the cable labels have been affixed to the cables except for any DAEs you have ordered. Additionally, if your system was not assembled at the factory, the cable kit supplied with your product will have all the required cables already labeled except for the DAEs.

## Cabling the DPE to a DAE

If you have one or more DAEs, these components must be cabled to the DPE back-end ports so that the storage is available in the system. Typically, the DAE(s) that are to be directly connected to the DPE need to be located close enough to the DPE so that the 2-meter DPE-to-DAE interconnect cables can be routed and connected to the DPE easily. 5- and 10-meter interconnect cables are available when you need to connect enclosures across multiple racks.

**NOTE:** General DAE back-end bus configuration rules:

1. Maximum number of enclosures per bus is 10.
2. Maximum number of drive slots per bus is 250, up to specific system limitations for drive slots.
3. For best performance, evenly distributing DAEs across the available back-end buses is recommended.

Consider the maximum number of drives supported by the storage system model. DAEs can be added to the system while the operating system is active and up to the DAE and drive slot limit for the storage system. DAEs or drive slots over the system limit will not be allowed to operate with the system.

Shown in the upcoming figures are examples of two-bus SAS cabling in this DPE-based storage platform. The storage processors connect to the DAEs with mini-SAS HD cables. The cables connect LCCs in the DAEs of a storage platform in a daisy-chain topology.

The mini-SAS HD ports on the storage processors in the DPE are labeled 0 and 1. Mini-SAS HD port 0 is connected internally to the SAS expander that connects the drives on the front of the DPE. The DPE and its front facing drives begin the first back-end bus, BE0, and is automatically enclosure 0 (EA0). We refer to the address of this enclosure as BE0 EA0.

**NOTE:** Each DAE supports two completely redundant connections to the DPE (LCC A and LCC B).

Since mini-SAS HD port 0 is already connected internally to the DPE drives, it is recommended that you connect the first optional DAE to the mini-SAS HD output port 1 of each storage processor to begin back-end bus 1 (BE1) and designate this DAE as enclosure 0 of this bus. We refer to the address of this enclosure as BE1 EA0.

In a two back-end bus system, it is recommended that you connect the second optional DAE to the mini-SAS HD port 0 of each storage processor.

## DAE load balancing

If your system has several optional DAEs, you can daisy-chain them within that bus. However, it is recommended that you balance each bus. In other words, always optimize your environment by using every available bus, and spreading the number of enclosures and drives as evenly as possible across the buses.

The rule of load or bus balancing is applied to all DAEs. BE0 EA0 (0\_0) is the DPE (SP A and B). So, to balance the load, the first DAE (LCC A and B) in the cabinet is BE1 EA0 (1\_0) and with the second DAE BE0 EA1 (0\_1), and so on.

## Cabling the first optional DAE to create back-end bus 1

Connect the first optional expansion DAE to port 1 of the DPE to create back-end bus 1 (BE1) and designate this DAE as enclosure 0 of this bus. We refer to the address of this enclosure as BE1 EA0 (1\_0).

### Prerequisites

To prepare for this cabling task:

- Locate the mini-SAS HD cables to be used to connect to the newly installed expansion DAE.  
Typically these cables are 2-meters long. You use longer cables, typically 5-meters or 8-meters, to connect enclosures located in different racks. Cables are shipped without labels attached. The cables and ports are not colored.
- Locate the sheet of cable labels provided.

Orient the cable connectors as described in the procedure that follows, making sure that you do NOT connect:

- A DAE expansion port 0 to another expansion port 0.
- Any A-side ports to B-side ports.

### About this task

Use the following illustrations to complete this cabling task:

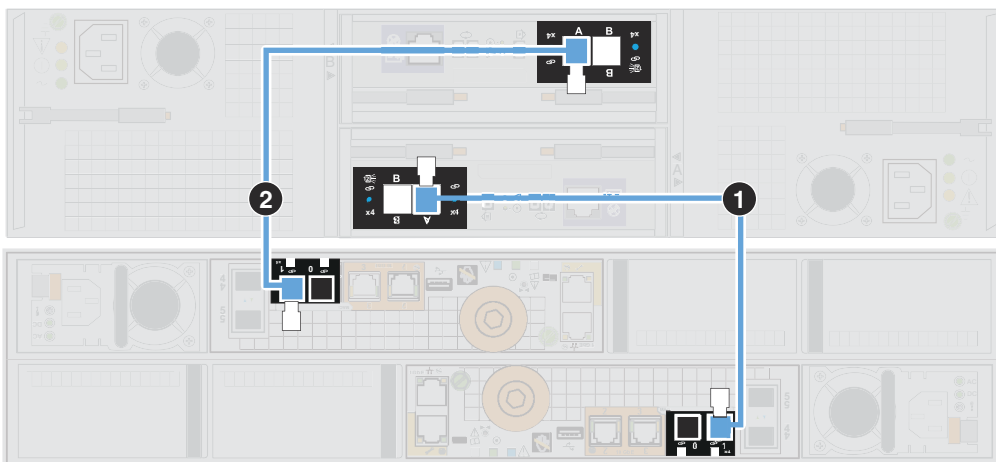

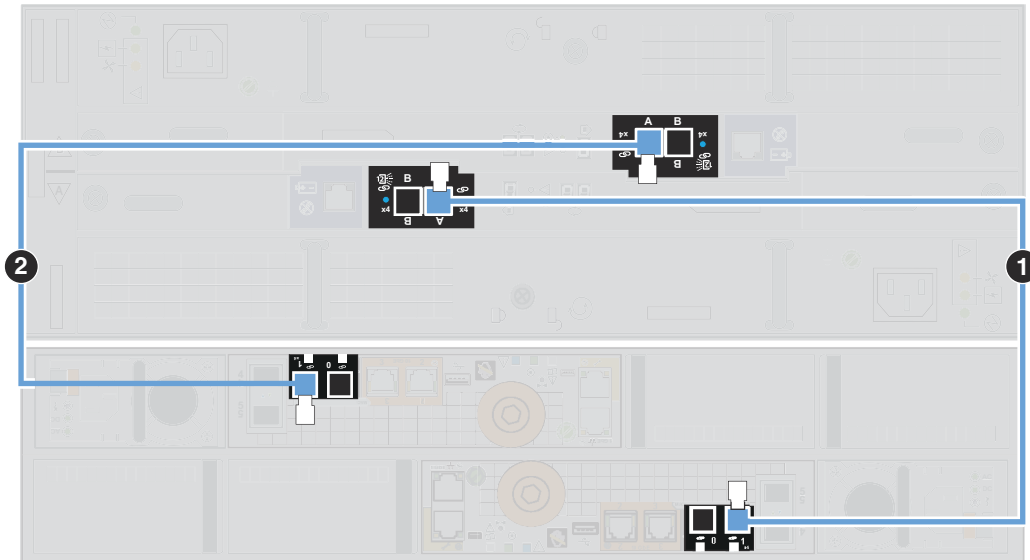

**Figure 34. Example: DPE to DAE BE1 enclosure 0**

**NOTE:** When cabling the 15-drive DAE LCC SAS ports, ensure that the cables do not overlap behind the DAE. The illustration above demonstrates the proper method for cabling to the DAE LCC SAS ports.

**Steps**

1. Label a pair of mini-SAS HD cables using the blue labels shown here.

Expansion port cable labeling details			Primary port cable labeling details		
Label part number	Label	Port	Label part number	Label	Port
046-001-562	046-001-562_xx SP A SAS 1 SP A SAS 1 SP A SAS 1 SP A SAS 1	SP A SAS 1	046-021-012	046-021-012_xx LCC A PORT A LCC A PORT A LCC A PORT A LCC A PORT A	LCC A Port A
046-003-750	046-003-750_xx SP B SAS 1 SP B SAS 1 SP B SAS 1 SP B SAS 1	SP B SAS 1	046-021-013	046-021-013_xx LCC B PORT A LCC B PORT A LCC B PORT A LCC B PORT A	LCC B Port A

2. Connect each SP to the first optional DAE to create BE1 EA0.

**NOTE:** Neither connector on the mini-SAS HD cable has a symbol to indicate input or output.

- a. Connect port 1 on SP A in the bottom slot in the DPE to port A on the link control card A (LCC A) at the bottom of the DAE. [ 1 ]
- b. Connect port 1 on SP B in the top slot in the DPE to port A on the link control card (LCC B) at the top of the DAE. [ 2 ]

## Cabling the second optional DAE to extend back-end bus 0

Connect the second optional expansion DAE to the DPE expansion port 0 to extend back-end bus 0 (BE0) and designate this DAE as enclosure 1 of this bus. We refer to the address of this enclosure as BE0 EA1 (0\_1).

### About this task

Use the following illustration to complete this cabling task:

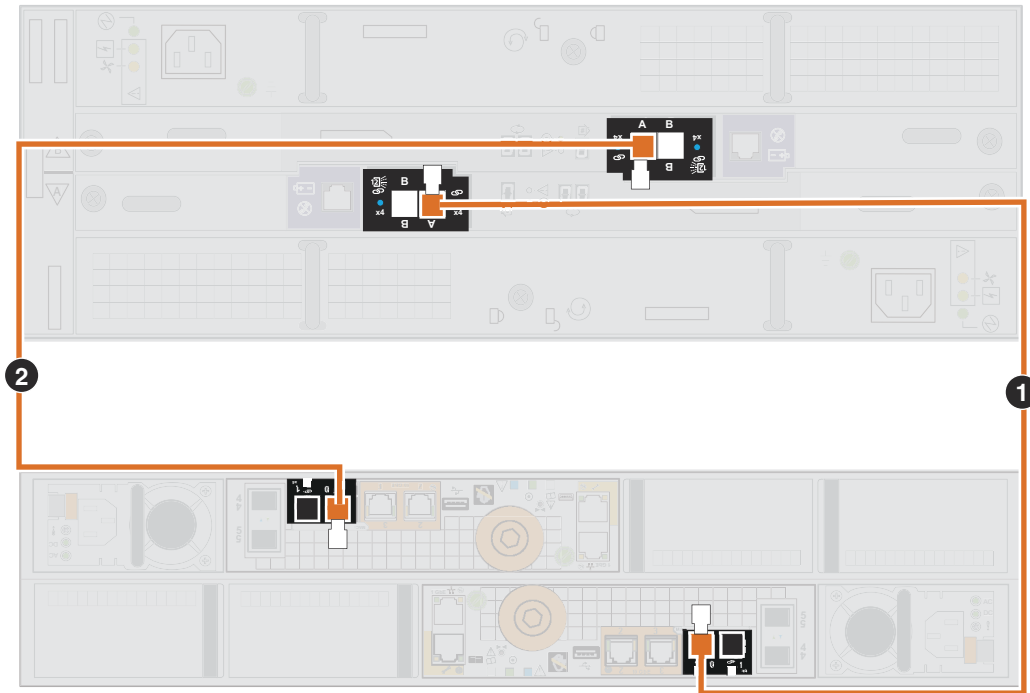

Figure 35. Example: DPE to 15-drive DAE

**NOTE:** When cabling the 15-drive DAE LCC SAS ports, ensure that the cables do not overlap behind the DAE. The illustration above demonstrates the proper method for cabling to the DAE LCC SAS ports.

### Steps

1. Label a pair of mini-SAS HD cables using the orange labels shown here.

Expansion port cable labeling details			Primary port cable labeling details		
Label part number	Label	Port	Label part number	Label	Port
046-001-561	046-001-561_xx	SP A SAS 0	046-021-010	046-021-010_xx	LCC A Port A
	SP A SAS 0			LCC A PORT A	
	SP A SAS 0			LCC A PORT A	
	SP A SAS 0			LCC A PORT A	
046-003-489	046-003-489_xx	SP B SAS 0	046-021-011	046-021-011_xx	LCC B Port A
	SP B SAS 0			LCC B PORT A	
	SP B SAS 0			LCC B PORT A	
	SP B SAS 0			LCC B PORT A	

2. Connect DPE port 0 to the new DAE to extend BE0.
  - a. Connect port 0 on SP A in the bottom slot in the DPE to port A on the link control card A (LCC A) at the bottom of the DAE. [1]
  - b. Connect port 0 on SP B in the top slot in the DPE to port A on the link control card (LCC B) at the top of the DAE. [2]

## Cabling the DPE SAS module ports to create back-end buses 2 through 5

Where supported, the following example shows how to connect remaining four SAS back-end ports and shows the cable labels for these SAS cables, as well as the back-end bus and enclosure numbers for these DPE to DAE connections.

### About this task

**NOTE:** The optional back-end 12-Gb/s SAS module is not supported on all Unity storage systems.

Cable the DAE to the 12-Gb/s SAS modules in the DPE 0, port 0 through port 3, to create back-end bus 2 through 5, BE2-BE5.

Use the following illustration to complete this cabling task:

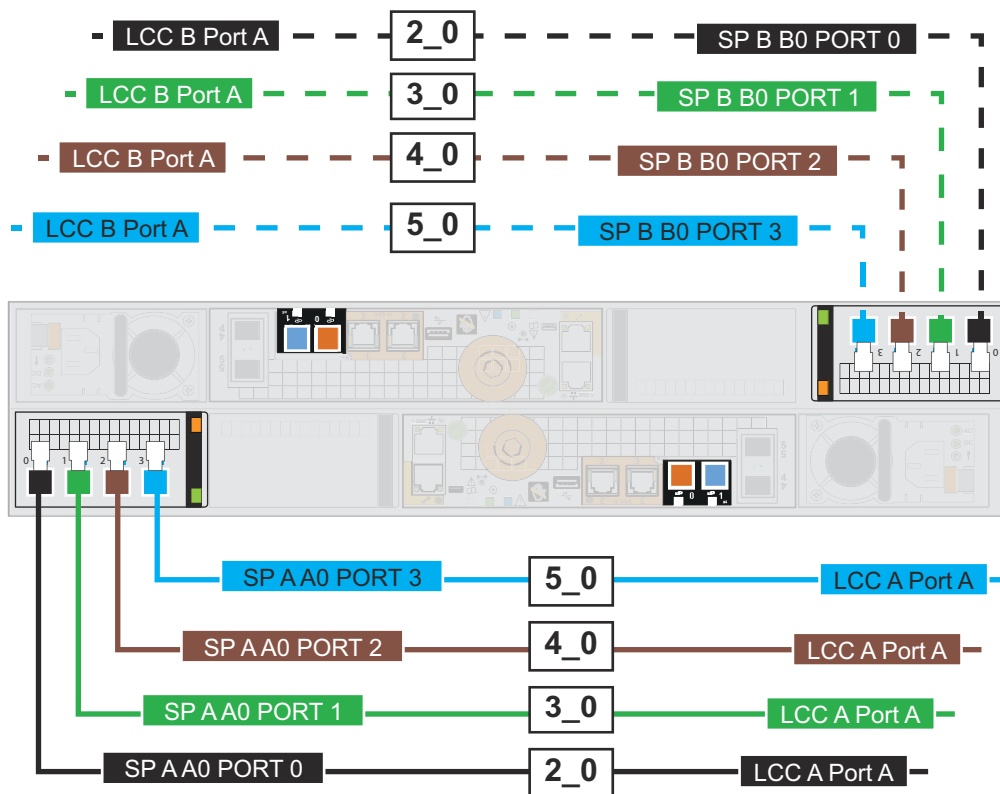

**Figure 36. Bus 2, Bus 3, Bus 4, and Bus 5 enclosure 0 SAS cabling**

- 2\_0 side A, black, SP A B0 port 0 to DAE <w> LCC A port A
- 2\_0 side B, black, SP B B0 port 0 to DAE <w> LCC B port A
- 3\_0 side A, green, SP A B0 port 1 to DAE <x> LCC A port A
- 3\_0 side B, green, SP B B0 port 1 to DAE <x> LCC B port A
- 4\_0 side A, brown, SP A B0 port 2 to DAE <y> LCC A port A
- 4\_0 side B, brown, SP B B0 port 2 to DAE <y> LCC B port A
- 5\_0 side A, cyan, SP A B0 port 3 to DAE <z> LCC A port A
- 5\_0 side B, cyan, SP B B0 port 3 to DAE <z> LCC B port A

For each new BE2-BE5:

**Steps**

1. Label a pair of mini-SAS HD cables using the appropriate labels (black, green, brown, or cyan) shown here.

Expansion port cable labeling details			Primary port cable labeling details		
Label part number	Label	Port	Label part number	Label	Port
046-005-679	<div style="background-color: black; color: white; padding: 2px; margin-bottom: 2px;">046-005-679_xx</div> <div style="background-color: black; color: white; padding: 2px; margin-bottom: 2px;">SP A A0 PORT 0</div> <div style="background-color: black; color: white; padding: 2px; margin-bottom: 2px;">SP A A0 PORT 0</div> <div style="background-color: black; color: white; padding: 2px; margin-bottom: 2px;">SP A A0 PORT 0</div> <div style="background-color: black; color: white; padding: 2px;">SP A A0 PORT 0</div>	SP A A0 PORT 0	046-021-16	<div style="background-color: black; color: white; padding: 2px; margin-bottom: 2px;">046-021-016_xx</div> <div style="background-color: black; color: white; padding: 2px; margin-bottom: 2px;">LCC A Port A</div> <div style="background-color: black; color: white; padding: 2px; margin-bottom: 2px;">LCC A Port A</div> <div style="background-color: black; color: white; padding: 2px; margin-bottom: 2px;">LCC A Port A</div> <div style="background-color: black; color: white; padding: 2px;">LCC A Port A</div>	LCC A Port A
046-005-718	<div style="background-color: black; color: white; padding: 2px; margin-bottom: 2px;">046-005-718_xx</div> <div style="background-color: black; color: white; padding: 2px; margin-bottom: 2px;">SP B B0 PORT 0</div> <div style="background-color: black; color: white; padding: 2px; margin-bottom: 2px;">SP B B0 PORT 0</div> <div style="background-color: black; color: white; padding: 2px; margin-bottom: 2px;">SP B B0 PORT 0</div> <div style="background-color: black; color: white; padding: 2px;">SP B B0 PORT 0</div>	SP B B0 PORT 0	046-021-017	<div style="background-color: black; color: white; padding: 2px; margin-bottom: 2px;">046-021-017_xx</div> <div style="background-color: black; color: white; padding: 2px; margin-bottom: 2px;">LCC B Port A</div> <div style="background-color: black; color: white; padding: 2px; margin-bottom: 2px;">LCC B Port A</div> <div style="background-color: black; color: white; padding: 2px; margin-bottom: 2px;">LCC B Port A</div> <div style="background-color: black; color: white; padding: 2px;">LCC B Port A</div>	LCC B Port A
046-005-711	<div style="background-color: green; color: white; padding: 2px; margin-bottom: 2px;">046-005-679_xx</div> <div style="background-color: green; color: white; padding: 2px; margin-bottom: 2px;">SP A A0 PORT 1</div> <div style="background-color: green; color: white; padding: 2px; margin-bottom: 2px;">SP A A0 PORT 1</div> <div style="background-color: green; color: white; padding: 2px; margin-bottom: 2px;">SP A A0 PORT 1</div> <div style="background-color: green; color: white; padding: 2px;">SP A A0 PORT 1</div>	SP A A0 PORT 1	046-021-018	<div style="background-color: green; color: white; padding: 2px; margin-bottom: 2px;">046-021-018_xx</div> <div style="background-color: green; color: white; padding: 2px; margin-bottom: 2px;">LCC A Port A</div> <div style="background-color: green; color: white; padding: 2px; margin-bottom: 2px;">LCC A Port A</div> <div style="background-color: green; color: white; padding: 2px; margin-bottom: 2px;">LCC A Port A</div> <div style="background-color: green; color: white; padding: 2px;">LCC A Port A</div>	LCC A Port A
046-005-719	<div style="background-color: green; color: white; padding: 2px; margin-bottom: 2px;">046-005-718_xx</div> <div style="background-color: green; color: white; padding: 2px; margin-bottom: 2px;">SP B B0 PORT 1</div> <div style="background-color: green; color: white; padding: 2px; margin-bottom: 2px;">SP B B0 PORT 1</div> <div style="background-color: green; color: white; padding: 2px; margin-bottom: 2px;">SP B B0 PORT 1</div> <div style="background-color: green; color: white; padding: 2px;">SP B B0 PORT 1</div>	SP B B0 PORT 1	046-021-019	<div style="background-color: green; color: white; padding: 2px; margin-bottom: 2px;">046-021-019_xx</div> <div style="background-color: green; color: white; padding: 2px; margin-bottom: 2px;">LCC B Port A</div> <div style="background-color: green; color: white; padding: 2px; margin-bottom: 2px;">LCC B Port A</div> <div style="background-color: green; color: white; padding: 2px; margin-bottom: 2px;">LCC B Port A</div> <div style="background-color: green; color: white; padding: 2px;">LCC B Port A</div>	LCC B Port A
046-005-935	<div style="background-color: brown; color: white; padding: 2px; margin-bottom: 2px;">046-005-679_xx</div> <div style="background-color: brown; color: white; padding: 2px; margin-bottom: 2px;">SP A A0 PORT 2</div> <div style="background-color: brown; color: white; padding: 2px; margin-bottom: 2px;">SP A A0 PORT 2</div> <div style="background-color: brown; color: white; padding: 2px; margin-bottom: 2px;">SP A A0 PORT 2</div> <div style="background-color: brown; color: white; padding: 2px;">SP A A0 PORT 2</div>	SP A A0 PORT 2	046-021-020	<div style="background-color: brown; color: white; padding: 2px; margin-bottom: 2px;">046-021-020_xx</div> <div style="background-color: brown; color: white; padding: 2px; margin-bottom: 2px;">LCC A Port A</div> <div style="background-color: brown; color: white; padding: 2px; margin-bottom: 2px;">LCC A Port A</div> <div style="background-color: brown; color: white; padding: 2px; margin-bottom: 2px;">LCC A Port A</div> <div style="background-color: brown; color: white; padding: 2px;">LCC A Port A</div>	LCC A Port A
046-005-937	<div style="background-color: brown; color: white; padding: 2px; margin-bottom: 2px;">046-005-718_xx</div> <div style="background-color: brown; color: white; padding: 2px; margin-bottom: 2px;">SP B B0 PORT 2</div> <div style="background-color: brown; color: white; padding: 2px; margin-bottom: 2px;">SP B B0 PORT 2</div> <div style="background-color: brown; color: white; padding: 2px; margin-bottom: 2px;">SP B B0 PORT 2</div> <div style="background-color: brown; color: white; padding: 2px;">SP B B0 PORT 2</div>	SP B B0 PORT 2	046-021-021	<div style="background-color: brown; color: white; padding: 2px; margin-bottom: 2px;">046-021-021_xx</div> <div style="background-color: brown; color: white; padding: 2px; margin-bottom: 2px;">LCC B Port A</div> <div style="background-color: brown; color: white; padding: 2px; margin-bottom: 2px;">LCC B Port A</div> <div style="background-color: brown; color: white; padding: 2px; margin-bottom: 2px;">LCC B Port A</div> <div style="background-color: brown; color: white; padding: 2px;">LCC B Port A</div>	LCC B Port A
046-005-936	<div style="background-color: cyan; color: white; padding: 2px; margin-bottom: 2px;">046-005-679_xx</div> <div style="background-color: cyan; color: white; padding: 2px; margin-bottom: 2px;">SP A A0 PORT 3</div> <div style="background-color: cyan; color: white; padding: 2px; margin-bottom: 2px;">SP A A0 PORT 3</div> <div style="background-color: cyan; color: white; padding: 2px; margin-bottom: 2px;">SP A A0 PORT 3</div> <div style="background-color: cyan; color: white; padding: 2px;">SP A A0 PORT 3</div>	SP A A0 PORT 3	046-021-022	<div style="background-color: cyan; color: white; padding: 2px; margin-bottom: 2px;">046-021-022_xx</div> <div style="background-color: cyan; color: white; padding: 2px; margin-bottom: 2px;">LCC A Port A</div> <div style="background-color: cyan; color: white; padding: 2px; margin-bottom: 2px;">LCC A Port A</div> <div style="background-color: cyan; color: white; padding: 2px; margin-bottom: 2px;">LCC A Port A</div> <div style="background-color: cyan; color: white; padding: 2px;">LCC A Port A</div>	LCC A Port A

Expansion port cable labeling details			Primary port cable labeling details		
Label part number	Label	Port	Label part number	Label	Port
046-005-938	<div style="background-color: #0070C0; color: white; padding: 2px;">046-005-718_xx</div> <div style="background-color: #0070C0; color: white; padding: 2px;">SP B B0 PORT 3</div> <div style="background-color: #0070C0; color: white; padding: 2px;">SP B B0 PORT 3</div> <div style="background-color: #0070C0; color: white; padding: 2px;">SP B B0 PORT 3</div> <div style="background-color: #0070C0; color: white; padding: 2px;">SP B B0 PORT 3</div>	SP B B0 PORT 3	046-021-023	<div style="background-color: #0070C0; color: white; padding: 2px;">046-021-023_xx</div> <div style="background-color: #0070C0; color: white; padding: 2px;">LCC B Port A</div> <div style="background-color: #0070C0; color: white; padding: 2px;">LCC B Port A</div> <div style="background-color: #0070C0; color: white; padding: 2px;">LCC B Port A</div> <div style="background-color: #0070C0; color: white; padding: 2px;">LCC B Port A</div>	LCC B Port A

2. Connect each SP to the optional DAE to create BE2 enclosure 0 through BE5 enclosure 0, as needed.
  - a. For SP A, connect the lowest available port in the SAS module in the bottom slot of the DPE to port A on the link control card A (LCC A) at the bottom of the DAE.
  - b. For SP B, connect the lowest available port in the SAS module in the top slot of the DPE to port A on the link control card B (LCC B) at the top of the DAE.

**Connect the DAE to the DPE SP slot 0 port 0 to create back-end bus 2, BE2**

Connect the DAE to the DPE SP slot 0 port 0 to create back-end bus 2 (BE2) and designate this DAE as enclosure 0 of this bus. We refer to the address of this enclosure as BE2 EA0 (2\_0).

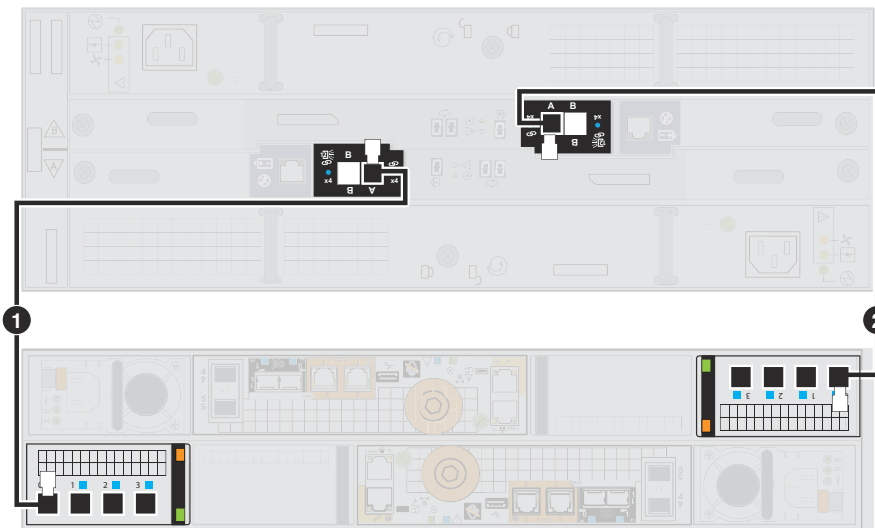

**Figure 37. Example: DPE to 15-drive DAE BE2 enclosure 0**

**NOTE:** When cabling the 15-drive DAE LCC SAS ports, ensure that the cables do not overlap behind the DAE. The illustration above demonstrates the proper method for cabling to the DAE LCC SAS ports.

1. Label a pair of mini-SAS HD cables using the black labels shown here.

Expansion port cable labeling details			Primary port cable labeling details		
Label part number	Label	Port	Label part number	Label	Port
046-005-679	<div style="background-color: #000000; color: white; padding: 2px;">046-005-679_xx</div> <div style="background-color: #000000; color: white; padding: 2px;">SP A A0 PORT 0</div> <div style="background-color: #000000; color: white; padding: 2px;">SP A A0 PORT 0</div> <div style="background-color: #000000; color: white; padding: 2px;">SP A A0 PORT 0</div> <div style="background-color: #000000; color: white; padding: 2px;">SP A A0 PORT 0</div>	SP A A0 PORT 0	046-021-016	<div style="background-color: #000000; color: white; padding: 2px;">046-021-016_xx</div> <div style="background-color: #000000; color: white; padding: 2px;">LCC A Port A</div> <div style="background-color: #000000; color: white; padding: 2px;">LCC A Port A</div> <div style="background-color: #000000; color: white; padding: 2px;">LCC A Port A</div> <div style="background-color: #000000; color: white; padding: 2px;">LCC A Port A</div>	LCC A Port A

Expansion port cable labeling details			Primary port cable labeling details		
Label part number	Label	Port	Label part number	Label	Port
046-005-718	<div style="background-color: black; color: white; padding: 2px;">046-005-718_xx</div> <div style="background-color: black; color: white; padding: 2px;">SP B B0 PORT 0</div> <div style="background-color: black; color: white; padding: 2px;">SP B B0 PORT 0</div> <div style="background-color: black; color: white; padding: 2px;">SP B B0 PORT 0</div> <div style="background-color: black; color: white; padding: 2px;">SP B B0 PORT 0</div>	SP B B0 PORT 0	046-021-017	<div style="background-color: black; color: white; padding: 2px;">046-021-017_xx</div> <div style="background-color: black; color: white; padding: 2px;">LCC B Port A</div> <div style="background-color: black; color: white; padding: 2px;">LCC B Port A</div> <div style="background-color: black; color: white; padding: 2px;">LCC B Port A</div> <div style="background-color: black; color: white; padding: 2px;">LCC B Port A</div>	LCC B Port A

2. Connect slot 0 port 0 on SP A in the bottom slot in the DPE to port A on the link control card A (LCC A) at the bottom of the DAE. [ 1 ]
3. Connect slot 0 port 0 on SP B in the top slot in the DPE to port A on the link control card (LCC B) at the top of the DAE. [ 2 ]

## Cabling an expansion DAE to an existing DAE to extend a back-end bus

Connect the optional expansion DAE to the last installed DAE in the back-end bus to extend to the new DAE.

### About this task

Use the following illustration to complete this cabling task:

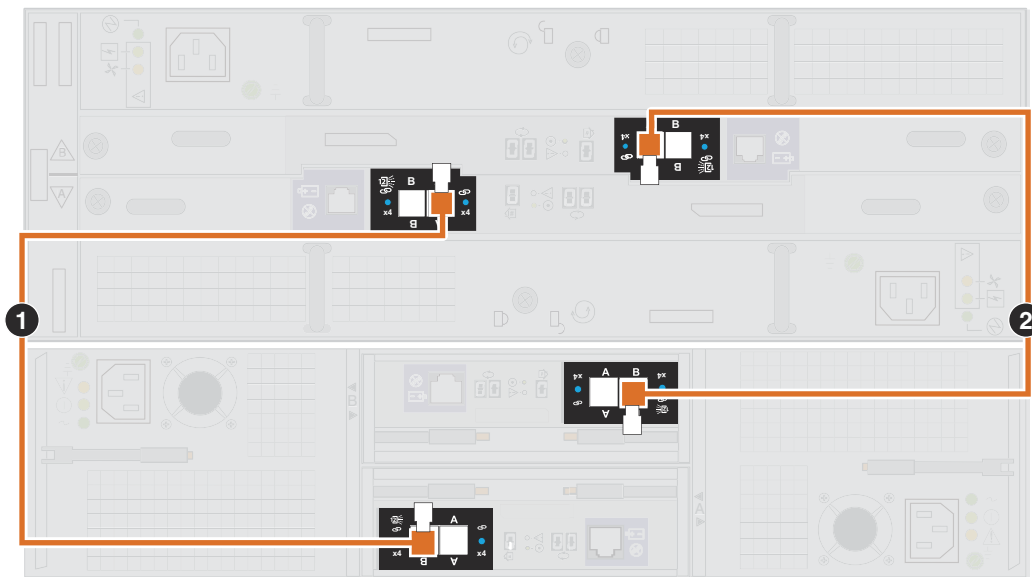

**Figure 38. Example: Extend SAS BE to new DAE**

**NOTE:** When cabling the 15-drive DAE LCC SAS ports, ensure that the cables do not overlap behind the DAE. The illustration above demonstrates the proper method for cabling to the DAE LCC SAS ports.

### Steps

1. Label a pair of mini-SAS HD cables using the appropriate labels (orange, blue, lack, green, brown, or cyan) shown here. Typically, DAEs connect to other DAEs using 1-meter cables.



Expansion port cable labeling details			Primary port cable labeling details		
Label part number	Label	Port	Label part number	Label	Port
046-004-455	<div style="background-color: #c00000; color: white; padding: 2px;">046-004-455_xx</div> <div style="background-color: #c00000; color: white; padding: 2px;">A BE0</div> <div style="background-color: #c00000; color: white; padding: 2px;">A BE0</div> <div style="background-color: #c00000; color: white; padding: 2px;">A BE0</div> <div style="background-color: #c00000; color: white; padding: 2px;">A BE0</div>	LCC A Port B	046-004-455	<div style="background-color: #c00000; color: white; padding: 2px;">046-004-455_xx</div> <div style="background-color: #c00000; color: white; padding: 2px;">A BE0</div> <div style="background-color: #c00000; color: white; padding: 2px;">A BE0</div> <div style="background-color: #c00000; color: white; padding: 2px;">A BE0</div> <div style="background-color: #c00000; color: white; padding: 2px;">A BE0</div>	LCC A Port A
046-004-463	<div style="background-color: #c00000; color: white; padding: 2px;">046-004-463_xx</div> <div style="background-color: #c00000; color: white; padding: 2px;">B BE0</div> <div style="background-color: #c00000; color: white; padding: 2px;">B BE0</div> <div style="background-color: #c00000; color: white; padding: 2px;">B BE0</div> <div style="background-color: #c00000; color: white; padding: 2px;">B BE0</div>	LCC B Port B	046-004-463	<div style="background-color: #c00000; color: white; padding: 2px;">046-004-463_xx</div> <div style="background-color: #c00000; color: white; padding: 2px;">B BE0</div> <div style="background-color: #c00000; color: white; padding: 2px;">B BE0</div> <div style="background-color: #c00000; color: white; padding: 2px;">B BE0</div> <div style="background-color: #c00000; color: white; padding: 2px;">B BE0</div>	LCC B Port A
046-004-456	<div style="background-color: #0070c0; color: white; padding: 2px;">046-004-456_xx</div> <div style="background-color: #0070c0; color: white; padding: 2px;">A BE1</div> <div style="background-color: #0070c0; color: white; padding: 2px;">A BE1</div> <div style="background-color: #0070c0; color: white; padding: 2px;">A BE1</div> <div style="background-color: #0070c0; color: white; padding: 2px;">A BE1</div>	LCC A Port B	046-004-456	<div style="background-color: #0070c0; color: white; padding: 2px;">046-004-456_xx</div> <div style="background-color: #0070c0; color: white; padding: 2px;">A BE1</div> <div style="background-color: #0070c0; color: white; padding: 2px;">A BE1</div> <div style="background-color: #0070c0; color: white; padding: 2px;">A BE1</div> <div style="background-color: #0070c0; color: white; padding: 2px;">A BE1</div>	LCC A Port A
046-004-464	<div style="background-color: #0070c0; color: white; padding: 2px;">046-004-464_xx</div> <div style="background-color: #0070c0; color: white; padding: 2px;">B BE1</div> <div style="background-color: #0070c0; color: white; padding: 2px;">B BE1</div> <div style="background-color: #0070c0; color: white; padding: 2px;">B BE1</div> <div style="background-color: #0070c0; color: white; padding: 2px;">B BE1</div>	LCC B Port B	046-004-464	<div style="background-color: #0070c0; color: white; padding: 2px;">046-004-464_xx</div> <div style="background-color: #0070c0; color: white; padding: 2px;">B BE1</div> <div style="background-color: #0070c0; color: white; padding: 2px;">B BE1</div> <div style="background-color: #0070c0; color: white; padding: 2px;">B BE1</div> <div style="background-color: #0070c0; color: white; padding: 2px;">B BE1</div>	LCC B Port A
046-004-457	<div style="background-color: #000000; color: white; padding: 2px;">046-004-457_xx</div> <div style="background-color: #000000; color: white; padding: 2px;">A BE2</div> <div style="background-color: #000000; color: white; padding: 2px;">A BE2</div> <div style="background-color: #000000; color: white; padding: 2px;">A BE2</div> <div style="background-color: #000000; color: white; padding: 2px;">A BE2</div>	LCC A Port B	046-004-457	<div style="background-color: #000000; color: white; padding: 2px;">046-004-457_xx</div> <div style="background-color: #000000; color: white; padding: 2px;">A BE2</div> <div style="background-color: #000000; color: white; padding: 2px;">A BE2</div> <div style="background-color: #000000; color: white; padding: 2px;">A BE2</div> <div style="background-color: #000000; color: white; padding: 2px;">A BE2</div>	LCC A Port A
046-004-465	<div style="background-color: #000000; color: white; padding: 2px;">046-004-465_xx</div> <div style="background-color: #000000; color: white; padding: 2px;">B BE2</div> <div style="background-color: #000000; color: white; padding: 2px;">B BE2</div> <div style="background-color: #000000; color: white; padding: 2px;">B BE2</div> <div style="background-color: #000000; color: white; padding: 2px;">B BE2</div>	LCC B Port B	046-004-465	<div style="background-color: #000000; color: white; padding: 2px;">046-004-465_xx</div> <div style="background-color: #000000; color: white; padding: 2px;">B BE2</div> <div style="background-color: #000000; color: white; padding: 2px;">B BE2</div> <div style="background-color: #000000; color: white; padding: 2px;">B BE2</div> <div style="background-color: #000000; color: white; padding: 2px;">B BE2</div>	LCC B Port A
046-004-458	<div style="background-color: #008000; color: white; padding: 2px;">046-004-458_xx</div> <div style="background-color: #008000; color: white; padding: 2px;">A BE3</div> <div style="background-color: #008000; color: white; padding: 2px;">A BE3</div> <div style="background-color: #008000; color: white; padding: 2px;">A BE3</div> <div style="background-color: #008000; color: white; padding: 2px;">A BE3</div>	LCC A Port B	046-004-458	<div style="background-color: #008000; color: white; padding: 2px;">046-004-458_xx</div> <div style="background-color: #008000; color: white; padding: 2px;">A BE3</div> <div style="background-color: #008000; color: white; padding: 2px;">A BE3</div> <div style="background-color: #008000; color: white; padding: 2px;">A BE3</div> <div style="background-color: #008000; color: white; padding: 2px;">A BE3</div>	LCC A Port A

Expansion port cable labeling details			Primary port cable labeling details		
Label part number	Label	Port	Label part number	Label	Port
046-004-466	<div style="background-color: #008000; color: white; padding: 2px; text-align: center;">046-004-466_xx</div> <div style="background-color: #008000; color: white; padding: 2px; text-align: center;">B BE3</div> <div style="background-color: #008000; color: white; padding: 2px; text-align: center;">B BE3</div> <div style="background-color: #008000; color: white; padding: 2px; text-align: center;">B BE3</div> <div style="background-color: #008000; color: white; padding: 2px; text-align: center;">B BE3</div>	LCC B Port B	046-004-466	<div style="background-color: #008000; color: white; padding: 2px; text-align: center;">046-004-466_xx</div> <div style="background-color: #008000; color: white; padding: 2px; text-align: center;">B BE3</div> <div style="background-color: #008000; color: white; padding: 2px; text-align: center;">B BE3</div> <div style="background-color: #008000; color: white; padding: 2px; text-align: center;">B BE3</div> <div style="background-color: #008000; color: white; padding: 2px; text-align: center;">B BE3</div>	LCC B Port A
046-004-459	<div style="background-color: #8B4513; color: white; padding: 2px; text-align: center;">046-004-459_xx</div> <div style="background-color: #8B4513; color: white; padding: 2px; text-align: center;">A BE4</div> <div style="background-color: #8B4513; color: white; padding: 2px; text-align: center;">A BE4</div> <div style="background-color: #8B4513; color: white; padding: 2px; text-align: center;">A BE4</div> <div style="background-color: #8B4513; color: white; padding: 2px; text-align: center;">A BE4</div>	LCC A Port B	046-004-459	<div style="background-color: #8B4513; color: white; padding: 2px; text-align: center;">046-004-459_xx</div> <div style="background-color: #8B4513; color: white; padding: 2px; text-align: center;">A BE4</div> <div style="background-color: #8B4513; color: white; padding: 2px; text-align: center;">A BE4</div> <div style="background-color: #8B4513; color: white; padding: 2px; text-align: center;">A BE4</div> <div style="background-color: #8B4513; color: white; padding: 2px; text-align: center;">A BE4</div>	LCC A Port A
046-004-467	<div style="background-color: #8B4513; color: white; padding: 2px; text-align: center;">046-004-467_xx</div> <div style="background-color: #8B4513; color: white; padding: 2px; text-align: center;">B BE4</div> <div style="background-color: #8B4513; color: white; padding: 2px; text-align: center;">B BE4</div> <div style="background-color: #8B4513; color: white; padding: 2px; text-align: center;">B BE4</div> <div style="background-color: #8B4513; color: white; padding: 2px; text-align: center;">B BE4</div>	LCC B Port B	046-004-467	<div style="background-color: #8B4513; color: white; padding: 2px; text-align: center;">046-004-467_xx</div> <div style="background-color: #8B4513; color: white; padding: 2px; text-align: center;">B BE4</div> <div style="background-color: #8B4513; color: white; padding: 2px; text-align: center;">B BE4</div> <div style="background-color: #8B4513; color: white; padding: 2px; text-align: center;">B BE4</div> <div style="background-color: #8B4513; color: white; padding: 2px; text-align: center;">B BE4</div>	LCC B Port A
046-004-460	<div style="background-color: #0070C0; color: white; padding: 2px; text-align: center;">046-004-460_xx</div> <div style="background-color: #0070C0; color: white; padding: 2px; text-align: center;">A BE5</div> <div style="background-color: #0070C0; color: white; padding: 2px; text-align: center;">A BE5</div> <div style="background-color: #0070C0; color: white; padding: 2px; text-align: center;">A BE5</div> <div style="background-color: #0070C0; color: white; padding: 2px; text-align: center;">A BE5</div>	LCC A Port B	046-004-460	<div style="background-color: #0070C0; color: white; padding: 2px; text-align: center;">046-004-460_xx</div> <div style="background-color: #0070C0; color: white; padding: 2px; text-align: center;">A BE5</div> <div style="background-color: #0070C0; color: white; padding: 2px; text-align: center;">A BE5</div> <div style="background-color: #0070C0; color: white; padding: 2px; text-align: center;">A BE5</div> <div style="background-color: #0070C0; color: white; padding: 2px; text-align: center;">A BE5</div>	LCC A Port A
046-004-468	<div style="background-color: #0070C0; color: white; padding: 2px; text-align: center;">046-004-468_xx</div> <div style="background-color: #0070C0; color: white; padding: 2px; text-align: center;">B BE5</div> <div style="background-color: #0070C0; color: white; padding: 2px; text-align: center;">B BE5</div> <div style="background-color: #0070C0; color: white; padding: 2px; text-align: center;">B BE5</div> <div style="background-color: #0070C0; color: white; padding: 2px; text-align: center;">B BE5</div>	LCC B Port B	046-004-468	<div style="background-color: #0070C0; color: white; padding: 2px; text-align: center;">046-004-468_xx</div> <div style="background-color: #0070C0; color: white; padding: 2px; text-align: center;">B BE5</div> <div style="background-color: #0070C0; color: white; padding: 2px; text-align: center;">B BE5</div> <div style="background-color: #0070C0; color: white; padding: 2px; text-align: center;">B BE5</div> <div style="background-color: #0070C0; color: white; padding: 2px; text-align: center;">B BE5</div>	LCC B Port A

2. Connect the existing DAE to the expansion DAE to extend that back-end.

If you have additional DAEs, add labels to the mini-SAS HD to mini-SAS HD cables and use those cables to extend the bus. For more information about cabling additional DAEs, see the associated *Hardware Information Guide*.

- a. Connect port B on the link control card A (LCC A) of the lower-numbered DAE to port A on the link control card A (LCC A) of the higher-numbered DAE. [1]  
LCC A is located on the lower portion of the DAE.
- b. Connect port B on the link control card B (LCC B) of the lower-numbered DAE to port A on the link control card B (LCC B) of the higher-numbered DAE. [2]  
LCC B is located on the upper portion of the DAE.

# 12Gb/s SAS cabling for interleaved DAE configurations

The interleaved DAE configuration is one of the racking methods available when installing optional DAEs. An interleaved configuration is when the optional DAEs across each of the back-end buses are racked in an interwoven manner.

## About interleaved DAE cabling conventions

The interleaved DAE example with Unity platform with nineteen DAEs (all are 2U, 25 drive DAEs) with a total of 500 drives (including the 25 drives in the DPE) across six back-end buses. As described previously, the onboard SAS ports on the DPE are labeled 0 and 1 and the optional SAS module, where supported, contains four additional SAS ports.

DPE SAS port 0 is connected internally to the SAS expander that connects to the front-facing drives in the DPE and thus begins back-end bus 0 and is enclosure 0 on this back-end (BE0 EA0). So when cabling the first expansion DAE, to balance the load, this DAE is cabled to DPE SAS port 1 to begin back-end bus 1 as enclosure 0 (BE1 EA0). Then, the rest of the DAEs in the bus are daisy-chained where they are intertwined. So, the 1st DAE is daisy-chained to the 7th DAE designated as BE1 EA1, and so on.

The 2nd DAE connects to DPE SAS port 0 to extend back-end bus 0 as enclosure 1 (BE0 EA1) and is daisy-chained to the 8th DAE, designated as BE0 EA2, and so on.

The 3rd DAE connects to DPE SAS module port 0 to begin back-end bus 2 as enclosure 0 (BE2 EA0) and is daisy-chained to the 9th DAE, designated as BE2 EA1, and so on.

The 4th DAE connects to DPE SAS module port 1 to begin back-end bus 3 as enclosure 0 (BE3 EA0) and is daisy-chained to the 10th DAE, designated as BE3 EA1, and so on.

The 5th DAE connects to DPE SAS module port 2 to begin back-end bus 4 as enclosure 0 (BE4 EA0) and is daisy-chained to the 11th DAE, designated as BE4 EA1, and so on.

Finally, the 6th DAE connects to DPE SAS module port 3 to begin back-end bus 5 as enclosure 0 (BE5 EA0) and is daisy-chained to the 12th DAE, designated as BE5 EA1, and so on.

## 19 2U DAEs in a interleaved configuration across 6 back-end buses

Example:	DAE number and address	DAE port connections	
		Port A (Input)	Port B (Output)
	1_3/DAE 19 - BE 1 EA 3 (Blue)	Connected to DAE 13	Not connected
	5_2/DAE 18 - BE 5 EA 2 (Cyan)	Connected to DAE 12	Not connected
	4_2/DAE 17 - BE 4 EA 2 (Brown)	Connected to DAE 11	Not connected
	3_2/DAE 16 - BE 3 EA 2 (Green)	Connected to DAE 10	Not connected
	2_2/DAE 15 - BE 2 EA 2 (Black)	Connected to DAE 9	Not connected
	0_3/DAE 14 - BE 0 EA 3 (Orange)	Connected to DAE 8	Not connected
	1_2/DAE 13 - BE 1 EA 2 (Blue)	Connected to DAE 7	Connected to DAE 19
	5_1/DAE 12 - BE 5 EA 1 (Cyan)	Connected to DAE 6	Connected to DAE 18
	4_1/DAE 11 - BE 4 EA 1 (Brown)	Connected to DAE 5	Connected to DAE 17
	3_1/DAE 10 - BE 3 EA 1 (Green)	Connected to DAE 4	Connected to DAE 16
	2_1/DAE 9 - BE 2 EA 1 (Black)	Connected to DAE 3	Connected to DAE 15
	0_2/DAE 8 - BE 0 EA 2 (Orange)	Connected to DAE 2	Connected to DAE 14
	1_1/DAE 7 - BE 1 EA 1 (Blue)	Connected to DAE 1	Connected to DAE 13
	5_0/DAE 6 - BE 5 EA 0 (Cyan)	Connected to DPE 0 port 3	Connected to DAE 12
	4_0/DAE 5 - BE 4 EA 0 (Brown)	Connected to DPE 0 port 2	Connected to DAE 11
	3_0/DAE 4 - BE 3 EA 0 (Green)	Connected to DPE 0 port 1	Connected to DAE 10
	2_0/DAE 3 - BE 2 EA 0 (Black)	Connected to DPE 0 port 0	Connected to DAE 9
	0_1/DAE 2 - BE 0 EA 1 (Orange)	Connected to DPE SAS 0	Connected to DAE 8
	1_0/DAE 1 - BE 1 EA 0 (Blue)	Connected to DPE SAS 1	Connected to DAE 2

# 12Gb/s SAS cabling for stacked DAE configurations

The stacked DAE configuration is another one of the racking methods available when installing optional DAEs. A stacked configuration is when the optional DAEs within a back-end loop are installed one on top of the other until all the DAEs in that loop are installed into the rack. Then, the next set of DAEs in the next back-end loop are installed.

## About stacked DAE cabling conventions

The stacked DAE example with Unity platform with nineteen DAEs (all are 2U, 25 drive DAEs) with a total of 500 drives (including the 25 drives in the DPE) across six back-end buses. As described previously, the onboard SAS ports on the DPE are labeled 0 and 1 and the optional SAS module, where supported, contains four additional SAS ports.

DPE SAS port 0 is connected internally to the SAS expander that connects to the front-facing drives in the DPE and thus begins back-end bus 0 and is enclosure 0 on this back-end (BE0 EA0). So when cabling the first expansion DAE, to balance the load, this DAE is cabled to DPE SAS port 1 to begin back-end bus 1 as enclosure 0 (BE1 EA0). Then, the rest of the DAEs in the bus are daisy-chained where they are stacked. So, the 1st DAE is daisy-chained to the 2nd DAE designated as BE1 EA1, and so on.

The 5th DAE connects to DPE SAS port 0 to extend back-end bus 0 as enclosure 1 (BE0 EA1) and is daisy-chained to the 6th DAE, designated as BE0 EA2, and so on.

The 8th DAE connects to DPE SAS module port 0 to begin back-end bus 2 as enclosure 0 (BE2 EA0) and is daisy-chained to the 9th DAE, designated as BE2 EA1, and so on.

The 11th DAE connects to DPE SAS module port 1 to begin back-end bus 3 as enclosure 0 (BE3 EA0) and is daisy-chained to the 12th DAE, designated as BE3 EA1, and so on.

The 14th DAE connects to DPE SAS module port 2 to begin back-end bus 4 as enclosure 0 (BE4 EA0) and is daisy-chained to the 15th DAE, designated as BE4 EA1, and so on.

Finally, the 17th DAE connects to DPE SAS module port 3 to begin back-end bus 5 as enclosure 0 (BE5 EA0) and is daisy-chained to the 18th DAE, designated as BE5 EA1, and so on.

## 19 2U DAEs in a stacked configuration across 6 back-end buses

Example:	DAE number and address	DAE port connections	
		Port A (Input)	Port B (Output)
	5_2/DAE 19 - BE 5 EA 2 (Cyan)	Connected to DAE 18	Not connected
	5_1/DAE 18 - BE 5 EA 1 (Cyan)	Connected to DAE 17	Connected to DAE 19
	5_0/DAE 17 - BE 5 EA 0 (Cyan)	Connected to DPE 0 port 3	Connected to DAE 18
	4_2/DAE 16 - BE 4 EA 2 (Brown)	Connected to DAE 15	Not connected
	4_1/DAE 15 - BE 4 EA 1 (Brown)	Connected to DAE 14	Connected to DAE 16
	4_0/DAE 14 - BE 4 EA 0 (Brown)	Connected to DPE 0 port 2	Connected to DAE 15
	3_2/DAE 13 - BE 3 EA 2 (Green)	Connected to DAE 12	Not connected
	3_1/DAE 12 - BE 3 EA 1 (Green)	Connected to DAE 11	Connected to DAE 13
	3_0/DAE 11 - BE 3 EA 0 (Green)	Connected to DPE 0 port 1	Connected to DAE 12
	2_2/DAE 10 - BE 2 EA 2 (Black)	Connected to DAE 9	Not connected
	2_1/DAE 9 - BE 2 EA 1 (Black)	Connected to DAE 10	Connected to DAE 8
	2_0/DAE 8 - BE 2 EA 0 (Black)	Connected to DPE 0 port 0	Connected to DAE 9
	0_3/DAE 7 - BE 0 EA 3 (Orange)	Connected to DAE 6	Not connected
	0_2/DAE 6 - BE 0 EA 2 (Orange)	Connected to DAE 5	Connected to DAE 7
	0_1/DAE 5 - BE 0 EA 1 (Orange)	Connected to DPE SAS 0	Connected to DAE 6
	1_3/DAE 4 - BE 1 EA 3 (Blue)	Connected to DAE 3	Not connected
	1_2/DAE 3 - BE 1 EA 2 (Blue)	Connected to DAE 2	Connected to DAE 4
	1_1/DAE 2 - BE 1 EA 2 (Blue)	Connected to DAE 1	Connected to DAE 3
	1_0/DAE 1 - BE 1 EA 0 (Blue)	Connected to DPE SAS 1	Connected to DAE 2

# Attaching expansion (back-end) cables to an 80-drive DAE

Do NOT FORCE the cable into a connector. A click indicates that the cable is completely seated in the connector.

## Prerequisites

To prepare for this cabling task:

- Locate the mini-SAS HD cables to be used to connect to the newly installed expansion DAE.  
Typically these cables are 2-meters long. You use longer cables, typically 5-meters or 8-meters, to connect enclosures located in different racks. Cables are shipped without labels attached. The cables and ports are not colored.
- Locate the sheet of cable labels provided.

Orient the cable connectors as described in the procedure that follows, making sure that you do NOT connect:

- A DAE expansion port 0 to another expansion port 0.
- Any A-side ports to B-side ports.

**i** **NOTE:** If you are connecting the 80-drive DAE to a 4-port SAS SLIC that requires x8 connectivity, insert the SAS cable into the 4-port SAS SLIC before persisting the SLIC. The 4-port SAS SLIC must be persisted with the cable inserted for x8 connectivity. If the SAS back-end SLIC is powered on without any cables inserted, it is automatically set at x4 and cannot be used for x8 lane cabling.

## Cabling for x4 connections

### About this task

The drives in the DPE are internally connected to the first back-end bus, which is bus 0. To maintain balance, the first DAE connected to the array should be connected to back-end bus 1. If the array only has 2 back end busses (0 and 1) then you should add DAEs by alternating between bus 0 and bus 1 to maintain an even distribution, or balance of drives over the busses.

If the array has a 4-port SAS I/O module, this would create additional back-end bus numbers 2 through 5. Maintain the same type of even distribution of drives over all of the back-end busses.

This section provides three different ways to connect the DAE to the array with an x4 connection.

- Connecting to back-end bus 1
- Connecting to back-end bus 0
- Connecting to a port on the SAS I/O module

Each installation may be different. Choose the connection option that suits your needs.

**Steps**

- Connect to back-end bus 1: To connect the first optional expansion DAE to back-end port 1 of the DPE to create back-end bus 1 (BE1) and designate this DAE as Enclosure Address 0 of this bus. We refer to the address of this enclosure as BE1 EAO (1\_0):
  1. Label a pair of mini-SAS HD cables using the blue labels shown here.

Expansion port cable labeling details			Primary port cable labeling details		
Label part number	Label	Port	Label part number	Label	Port
046-001-562	<div style="border: 1px solid black; padding: 2px; margin-bottom: 2px; font-size: 8px;">046-001-562_xx</div> <div style="border: 1px solid black; padding: 2px; margin-bottom: 2px; text-align: center;">SP A SAS 1</div> <div style="border: 1px solid black; padding: 2px; margin-bottom: 2px; text-align: center;">SP A SAS 1</div> <div style="border: 1px solid black; padding: 2px; margin-bottom: 2px; text-align: center;">SP A SAS 1</div> <div style="border: 1px solid black; padding: 2px; margin-bottom: 2px; text-align: center;">SP A SAS 1</div>	SP A SAS 1	046-021-012	<div style="border: 1px solid black; padding: 2px; margin-bottom: 2px; font-size: 8px;">046-021-012_xx</div> <div style="border: 1px solid black; padding: 2px; margin-bottom: 2px; text-align: center;">LCC A PORT A</div> <div style="border: 1px solid black; padding: 2px; margin-bottom: 2px; text-align: center;">LCC A PORT A</div> <div style="border: 1px solid black; padding: 2px; margin-bottom: 2px; text-align: center;">LCC A PORT A</div> <div style="border: 1px solid black; padding: 2px; margin-bottom: 2px; text-align: center;">LCC A PORT A</div>	LCC A Port A
046-003-750	<div style="border: 1px solid black; padding: 2px; margin-bottom: 2px; font-size: 8px;">046-003-750_xx</div> <div style="border: 1px solid black; padding: 2px; margin-bottom: 2px; text-align: center;">SP B SAS 1</div> <div style="border: 1px solid black; padding: 2px; margin-bottom: 2px; text-align: center;">SP B SAS 1</div> <div style="border: 1px solid black; padding: 2px; margin-bottom: 2px; text-align: center;">SP B SAS 1</div> <div style="border: 1px solid black; padding: 2px; margin-bottom: 2px; text-align: center;">SP B SAS 1</div>	SP B SAS 1	046-021-013	<div style="border: 1px solid black; padding: 2px; margin-bottom: 2px; font-size: 8px;">046-021-013_xx</div> <div style="border: 1px solid black; padding: 2px; margin-bottom: 2px; text-align: center;">LCC B PORT A</div> <div style="border: 1px solid black; padding: 2px; margin-bottom: 2px; text-align: center;">LCC B PORT A</div> <div style="border: 1px solid black; padding: 2px; margin-bottom: 2px; text-align: center;">LCC B PORT A</div> <div style="border: 1px solid black; padding: 2px; margin-bottom: 2px; text-align: center;">LCC B PORT A</div>	LCC B Port A

2. Connect the ports as follows:
  - Connect BE port 1 on SP A (the bottom storage processor of the DPE) to port A of link control card A (LCC A) on the right side of the DAE.
  - Connect BE port 1 on SP B (the top storage processor of the DPE) to port A of link control card B (LCC B) on the left side of the DAE.



- Connect to back-end bus 0: To connect the second optional expansion DAE to the DPE expansion port 0 to extend back-end bus 0 (BE0) and designate this DAE as Enclosure Address 1 of this bus. We refer to the address of this enclosure as BE0 EA1 (0\_1):
  1. Label a pair of mini-SAS HD cables using the orange labels shown here.

Expansion port cable labeling details			Primary port cable labeling details		
Label part number	Label	Port	Label part number	Label	Port
046-001-561	<div style="background-color: #e67e22; color: white; padding: 2px; text-align: center; font-size: 8px;">046-001-561_xx</div> <div style="background-color: #e67e22; color: white; padding: 2px; text-align: center; font-size: 10px;">SP A SAS 0</div> <div style="background-color: #e67e22; color: white; padding: 2px; text-align: center; font-size: 10px;">SP A SAS 0</div> <div style="background-color: #e67e22; color: white; padding: 2px; text-align: center; font-size: 10px;">SP A SAS 0</div> <div style="background-color: #e67e22; color: white; padding: 2px; text-align: center; font-size: 10px;">SP A SAS 0</div>	SP A SAS 0	046-021-010	<div style="background-color: #e67e22; color: white; padding: 2px; text-align: center; font-size: 8px;">046-021-010_xx</div> <div style="background-color: #e67e22; color: white; padding: 2px; text-align: center; font-size: 10px;">LCC A PORT A</div> <div style="background-color: #e67e22; color: white; padding: 2px; text-align: center; font-size: 10px;">LCC A PORT A</div> <div style="background-color: #e67e22; color: white; padding: 2px; text-align: center; font-size: 10px;">LCC A PORT A</div> <div style="background-color: #e67e22; color: white; padding: 2px; text-align: center; font-size: 10px;">LCC A PORT A</div>	LCC A Port A
046-003-489	<div style="background-color: #e67e22; color: white; padding: 2px; text-align: center; font-size: 8px;">046-003-489_xx</div> <div style="background-color: #e67e22; color: white; padding: 2px; text-align: center; font-size: 10px;">SP B SAS 0</div> <div style="background-color: #e67e22; color: white; padding: 2px; text-align: center; font-size: 10px;">SP B SAS 0</div> <div style="background-color: #e67e22; color: white; padding: 2px; text-align: center; font-size: 10px;">SP B SAS 0</div> <div style="background-color: #e67e22; color: white; padding: 2px; text-align: center; font-size: 10px;">SP B SAS 0</div>	SP B SAS 0	046-021-011	<div style="background-color: #e67e22; color: white; padding: 2px; text-align: center; font-size: 8px;">046-021-011_xx</div> <div style="background-color: #e67e22; color: white; padding: 2px; text-align: center; font-size: 10px;">LCC B PORT A</div> <div style="background-color: #e67e22; color: white; padding: 2px; text-align: center; font-size: 10px;">LCC B PORT A</div> <div style="background-color: #e67e22; color: white; padding: 2px; text-align: center; font-size: 10px;">LCC B PORT A</div> <div style="background-color: #e67e22; color: white; padding: 2px; text-align: center; font-size: 10px;">LCC B PORT A</div>	LCC B Port A

2. Connect the ports as follows:
  - Connect BE port 0 on SP A (the bottom storage processor of the DPE) to port A of link control card A (LCC A) on the right side of the DAE.
  - Connect port 0 on SP B (the top storage processor of the DPE) to port A of link control card B (LCC B) on the left side of the DAE .

- Connect to the 4-port SAS back-end I/O module: To connect the DAE to a BE port in the SAS I/O module of the storage processor, cable the DAE to the first available port in the 12-Gb/s SAS I/O module. Use the same port on each storage processor's SAS I/O module. This SAS I/O module can be used to create back-end bus 2 through 5, (BE2 through BE5):

**NOTE:** The optional back-end 12-Gb/s SAS module is not supported on all Unity storage systems.

**NOTE:** Adding a new 12-Gb/s SAS I/O module requires a coordinated restart of the array. Refer to *Adding an optional I/O module* for more information.

1. Label a pair of mini-SAS HD cables using the appropriate labels (black, green, brown, or blue) shown here.

Expansion port cable labeling details			Primary port cable labeling details		
Label part number	Label	Port	Label part number	Label	Port
046-005-679		SP A A0 PORT 0	046-021-16		LCC A Port A
046-005-718		SP B B0 PORT 0	046-021-017		LCC B Port A
046-005-711		SP A A0 PORT 1	046-021-018		LCC A Port A
046-005-719		SP B B0 PORT 1	046-021-019		LCC B Port A
046-005-935		SP A A0 PORT 2	046-021-020		LCC A Port A
046-005-937		SP B B0 PORT 2	046-021-021		LCC B Port A

Expansion port cable labeling details			Primary port cable labeling details		
Label part number	Label	Port	Label part number	Label	Port
046-005-936	<div style="border: 1px solid black; background-color: #0070C0; color: white; padding: 2px; margin-bottom: 2px;">046-005-679_xx</div> <div style="border: 1px solid black; background-color: #0070C0; color: white; padding: 2px; margin-bottom: 2px;">SP A A0 PORT 3</div> <div style="border: 1px solid black; background-color: #0070C0; color: white; padding: 2px; margin-bottom: 2px;">SP A A0 PORT 3</div> <div style="border: 1px solid black; background-color: #0070C0; color: white; padding: 2px; margin-bottom: 2px;">SP A A0 PORT 3</div> <div style="border: 1px solid black; background-color: #0070C0; color: white; padding: 2px;">SP A A0 PORT 3</div>	SP A A0 PORT 3	046-021-022	<div style="border: 1px solid black; background-color: #0070C0; color: white; padding: 2px; margin-bottom: 2px;">046-021-022_xx</div> <div style="border: 1px solid black; background-color: #0070C0; color: white; padding: 2px; margin-bottom: 2px;">LCC A Port A</div> <div style="border: 1px solid black; background-color: #0070C0; color: white; padding: 2px; margin-bottom: 2px;">LCC A Port A</div> <div style="border: 1px solid black; background-color: #0070C0; color: white; padding: 2px; margin-bottom: 2px;">LCC A Port A</div> <div style="border: 1px solid black; background-color: #0070C0; color: white; padding: 2px;">LCC A Port A</div>	LCC A Port A
046-005-938	<div style="border: 1px solid black; background-color: #0070C0; color: white; padding: 2px; margin-bottom: 2px;">046-005-718_xx</div> <div style="border: 1px solid black; background-color: #0070C0; color: white; padding: 2px; margin-bottom: 2px;">SP B B0 PORT 3</div> <div style="border: 1px solid black; background-color: #0070C0; color: white; padding: 2px; margin-bottom: 2px;">SP B B0 PORT 3</div> <div style="border: 1px solid black; background-color: #0070C0; color: white; padding: 2px; margin-bottom: 2px;">SP B B0 PORT 3</div> <div style="border: 1px solid black; background-color: #0070C0; color: white; padding: 2px;">SP B B0 PORT 3</div>	SP B B0 PORT 3	046-021-023	<div style="border: 1px solid black; background-color: #0070C0; color: white; padding: 2px; margin-bottom: 2px;">046-021-023_xx</div> <div style="border: 1px solid black; background-color: #0070C0; color: white; padding: 2px; margin-bottom: 2px;">LCC B Port A</div> <div style="border: 1px solid black; background-color: #0070C0; color: white; padding: 2px; margin-bottom: 2px;">LCC B Port A</div> <div style="border: 1px solid black; background-color: #0070C0; color: white; padding: 2px; margin-bottom: 2px;">LCC B Port A</div> <div style="border: 1px solid black; background-color: #0070C0; color: white; padding: 2px;">LCC B Port A</div>	LCC B Port A

2. For SP A, connect the DAE cable to the lowest available port in the SAS module in the bottom storage processor of the DPE to port A on link control card AA/A (LCC A) on the right side of the DAE.
3. For SP B, connect the DAE cable to the lowest available port in the SAS module in the top storage processor of the DPE to port A on link control card BB/B (LCC B) on the left side of the DAE.

## Example

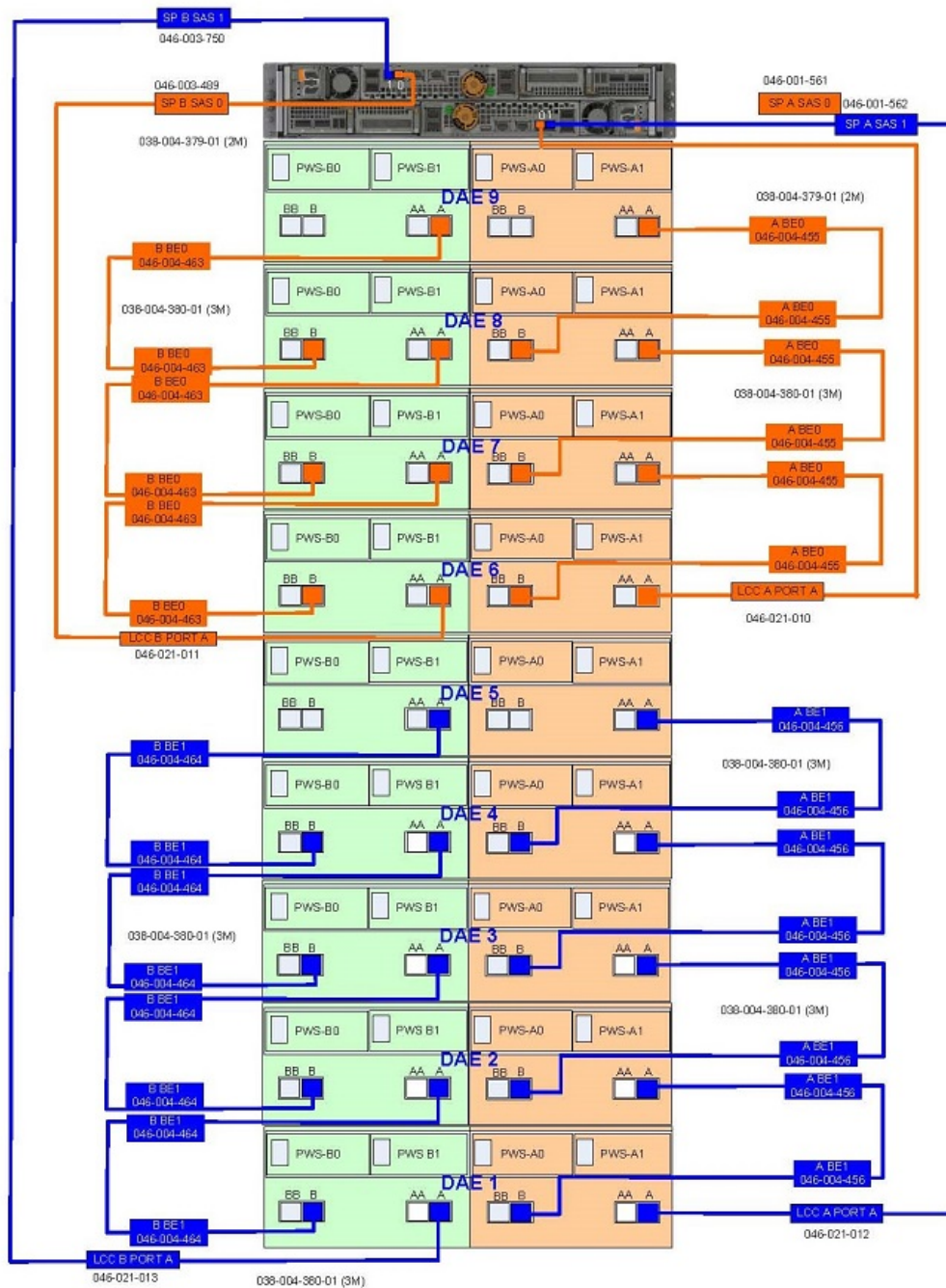

Figure 39. x4 cabling example

## Cabling for x8 connections

### Prerequisites

As previously noted, if you are connecting the DAE to a 4-port SAS I/O module that requires x8 connectivity, you must insert the SAS cable into the 4-port SAS I/O module before persisting it. The 4-port SAS I/O module must be persisted with the cable inserted for x8 connectivity. If the SAS back-end I/O module is powered on and persisted without any cables inserted, it is automatically set at x4 and cannot be used for x8 lane cabling.

**NOTE:** x8 connections can only be made using the 4-port back-end SAS I/O module. Never use ports 1 and 2 for x8 connections.

## Steps

- Connect to the 4-port SAS back-end I/O module: Insert SAS cables into ports 0 and 1 or ports 2 and 3 of the 4-port SAS I/O modules in the storage processor, if they are not connected already. For consistency and clarity, use ports 0 and 1 first. This will create BE bus 2. The next configured x8 bus using ports 2 and 3 will create BE 4.
1. Label a pair of mini-SAS HD cables using the black or green labels.
 

The labels used depend upon how the back-end ports are configured.
  2. Connect the ports as follows:
    - Ensure that the SAS cable is inserted into ports 0 and 1 or ports 2 and 3 of the SP A SAS module, located in the bottom storage processor of the DPE. Connect the cable to ports AA/A of link control card A (LCC A), located on the right side of the DAE.
    - Ensure that the SAS cable is inserted into ports 0 and 1 or ports 2 and 3 of SP B SAS module, located in the top storage processor of the DPE. Connect the cable to ports AA/A of link control card B (LCC B), located on the left side of the DAE.

## Example

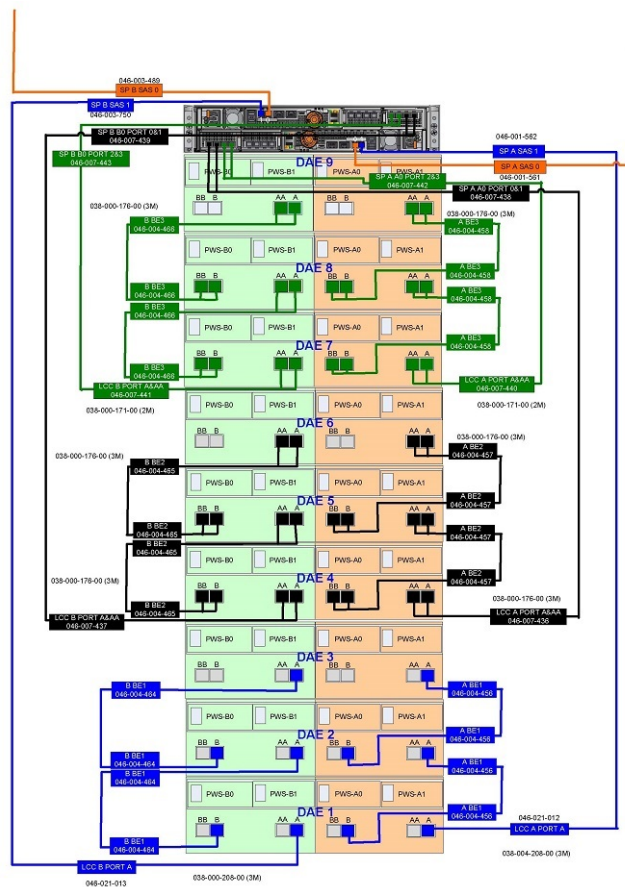

Figure 40. x8 cabling example

# Rail kits and cables

## Topics:

- [Rail kits](#)
- [Cable types](#)

## Rail kits

Dell sells rail kits for mounting system enclosures in 19-inch NEMA cabinets/racks and TELCO racks.

### Standard NEMA racks

Model number	Description	Allowable rail depth
D3DPE2URK12	Adjustable rail kit for 2U DPE with 12 drives	20.3" to 34" (51.6 cm to 84.4 cm)
D3DPE2URK25	Adjustable rail kit for 2U DPE with 25 drives	20.3" to 34" (51.6 cm to 84.4 cm)
D3DAE2URK	Adjustable rail kit for 2U DAE with 25 drives	20.3" to 34" (51.6 cm to 84.4 cm)
D3DAE3URK	Adjustable rail kit for 2U DAE with 15 drives	20.3" to 34" (51.6 cm to 84.4 cm)
D3DAE80RK	Adjustable rail kit for 3U DAE with 80 drives	18" to 36" (45.7 cm to 91.4 cm)

### TELCO racks

Model number	Description
VCTELCO3UDPE	TELCO tray for the 2U DPE with 25 drives
VCTELCO2UDPE	TELCO tray for the 2U DPE with 25 drives
VCTELCO3UDAE	TELCO rail kit for the 3U DAE with 25 drives
VCTELCO3UDAE	TELCO rail kit for the 2U DAE with 15 drives

## Cable types

Reference information detailing the SAS, optical, and Twin Ax cables and SFP+ modules used with your systems.

### SFP+ modules

Model Number	For:
D3SFP1	Copper 1 Gb SFP+ qty 4 for iSCSI connection
D3SFP8F	8 Gb SFP+ qty 4 for FC connection
D3SFP10I	10 Gb SFP+ qty 4 for iSCSI connection
D3SFP16F	16 Gb SFP+ qty 4 for FC connection

Model Number	For:
D3SFPSM16F	16 Gb SFP+ qty 4 for FC (Single Mode) connection

## Optical cables

Model Number:	For:
D3FC-OM3-1M	1 meter OM3 LC-LC Multi-mode 50UM fibre optic cable
D3FC-OM3-3M	3 meter OM3 LC-LC Multi-mode 50UM fibre optic cable
D3FC-OM3-5M	5 meter OM3 LC-LC Multi-mode 50UM fibre optic cable
D3FC-OM3-10M	10 meter OM3 LC-LC Multi-mode 50UM fibre optic cable
D3FC-OM3-30M	30 meter OM3 LC-LC Multi-mode 50UM fibre optic cable
D3FC-OM3-50M	50 meter OM3 LC-LC Multi-mode 50UM fibre optic cable
D3FC-OM3-100M	100 meter OM3 LC-LC Multi-mode 50UM fibre optic cable

## Active TwinAx cables

These models consist of a shielded, quad construction style cable with a 100 Ohm differential. Both ends of the cable have SFP+ style connectors that comply with SFF-8431 and SFF-8472 standards. The transmit and receive ends of the cable have active components to facilitate the transmission of 8 Gigabit or 10 Gigabit protocols. The use of DC blocking capacitors on the receiver is required per the SFF-8431 standard.

Model Number	For:
D3TX-TWAX-1M	1 meter SFP+ to SFP+ active 8 Gb/10 Gb cable
D3TX-TWAX-3M	3 meter SFP+ to SFP+ active 8 Gb/10 Gb cable
D3TX-TWAX-5M	5 meter SFP+ to SFP+ active 8 Gb/10 Gb cable

## Passive TwinAx cables

SFP+ Copper TwinAx cables are suitable for very short distances and offer a highly cost-effective way to connect within racks and across adjacent racks.

Model Number	For:
10G-SFPP-TWX-0101	1 meter SFP+ to SFP+ passive 10 Gb cable
10G-SFPP-TWX-0308	3 meter SFP+ to SFP+ passive 10 Gb cable
10G-SFPP-TWX-0508	5 meter SFP+ to SFP+ passive 10 Gb cable

## Back end SAS cables

Model Number	For:
D3MSHDMSSHD2	2 meter 12 Gb mini-SAS HD to mini-SAS HD cables
D3MSHDMSSHD5	5 meter 12 Gb mini-SAS HD to mini-SAS HD cables
D3MSHDMSSHD8	8 meter 12 Gb mini-SAS HD to mini-SAS HD cables

## DAE-to-DAE copper cabling

The expansion port interface to and between DAEs is copper cabling. The 100  $\Omega$  cables are keyed at either end, and available in 1- 10-meter lengths.

- DAE-to-DAE cables are SFF 8088 mini-SAS to mini-SAS.
- Keys are defined in the T10-SAS 2.1 specification.