

Cisco UCS B200 M6 Blade Server

A printed version of this document is only a copy and not necessarily the latest version. Refer to the following link for the latest released version:

<https://www.cisco.com/c/en/us/products/servers-unified-computing/ucs-b-series-blade-servers/datasheet-listing.html>

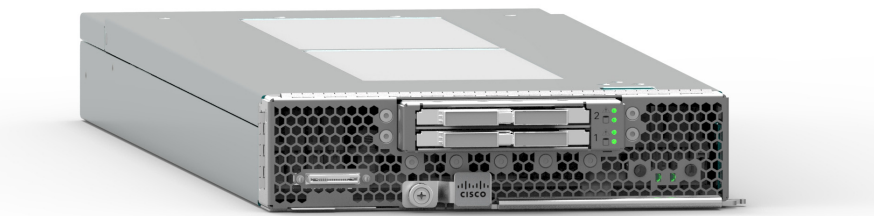

OVERVIEW	3
DETAILED VIEWS	4
Blade Server Front View	4
BASE SERVER STANDARD CAPABILITIES and FEATURES	5
CONFIGURING the SERVER	7
STEP 1 CHOOSE BASE SERVER SKU	8
STEP 2 CHOOSE CPU(S)	9
STEP 3 CHOOSE MEMORY	13
Memory Configurations, Features, and Modes	15
STEP 4 CHOOSE MLOM REAR MEZZANINE ADAPTER	21
STEP 5 CHOOSE OPTIONAL REAR MEZZANINE ADAPTERS (VIC or Port Expander)	23
STEP 6 CHOOSE OPTIONAL FRONT MEZZANINE ADAPTER	24
STEP 7 CHOOSE OPTIONAL DRIVES	25
STEP 8 CHOOSE TRUSTED PLATFORM MODULE	29
STEP 9 CHOOSE UCSM SOFTWARE	30
STEP 10 CHOOSE OPERATING SYSTEM AND VALUE-ADDED SOFTWARE	31
STEP 11 CHOOSE OPTIONAL RECOVERY MEDIA	35
STEP 12 CHOOSE SERVICE and SUPPORT LEVEL	36
Unified Computing Warranty, No Contract	36
Smart Net Total Care (SNTC) for Cisco UCS	36
Smart Net Total Care for Cisco UCS Onsite Troubleshooting Service	38
Solution Support for UCS	39
Smart Net Total Care for UCS Hardware Only Service	40
Partner Support Service for UCS	41
PSS for UCS Hardware Only	42
Unified Computing Combined Support Service	43
UCS Drive Retention Service	44
Local Language Technical Support for UCS	44
SUPPLEMENTAL MATERIAL	45
System Board	45
Memory Configuration and Mirroring	46
Memory Mirroring	48
Memory Support for 3rd Generation Intel® Xeon® Scalable Processors (Ice Lake)	49
PMem Support	49
App Direct Mode	49
Memory Mode	49
SPARE PARTS	50
UPGRADING or REPLACING CPUs	56
UPGRADING or REPLACING MEMORY	57
TECHNICAL SPECIFICATIONS	59
Dimensions and Weight	59
Power Specifications	59

OVERVIEW

Delivering performance, versatility and density without compromise, the Cisco UCS B200 M6 Blade Server addresses the broadest set of workloads, from IT and web infrastructure through distributed database.

The enterprise-class Cisco UCS B200 M6 blade server extends the capabilities of Cisco's Unified Computing System portfolio in a half-width blade form factor. The Cisco UCS B200 M6 harnesses the power of the latest 3rd Gen Intel® Xeon® Scalable Processors (Ice Lake) with:

- Up to 2 TB of RAM per CPU (using 16 x 128 GB DRAMs) or up to 5 TB per CPU (using 8 x 128 GB DRAMs and 8 x 512 GB Intel® Optane™ Persistent Memory Modules (PMem))
- Two solid-state drives (SSDs), or
- Two PCIe NVMe drives, or
- Mini storage carrier with M.2 SATA drives. UCS-M2-HWRAID is required when selecting the M.2 SATA drives.
- Up to 80 Gbps throughput connectivity.

The B200 M6 server is the follow-on server to the popular B200 M5 server and includes support for the following:

- 3rd Gen Intel® Xeon® Scalable Processors (Ice Lake).
- Up to 128 GB 3200-MHz DDR4 memory DIMMs.
- Up to 4 TB total memory (for 2 CPUs) is available if the memory slots are all populated with 32 x 128 GB DDR4 DIMMs or 10 GB total memory if the memory slots are populated with 16 x 128 GB DDR4 DIMMs and 16 x 512 GB PMem.
- Front mezzanine daughter card options
 - 12G RAID controller module with two 2.5-inch SAS/SATA SSD drives, or
 - Pass-through module with two 2.5-inch PCIe NVMe drives, or
 - Mini storage carrier with up to four M.2 SATA drives. UCS-M2-HWRAID is required when selecting the M.2 SATA drives.

Figure 1 Cisco UCS B200 M6 Blade Server

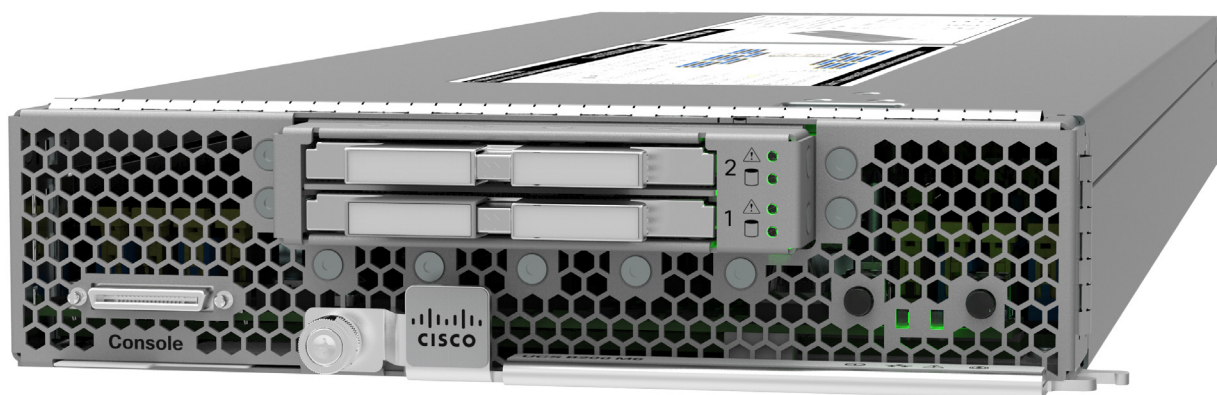

DETAILED VIEWS

Blade Server Front View

Figure 2 is a detailed front view of the Cisco UCS B200 M6 Blade Server.

Figure 2 Blade Server Front View

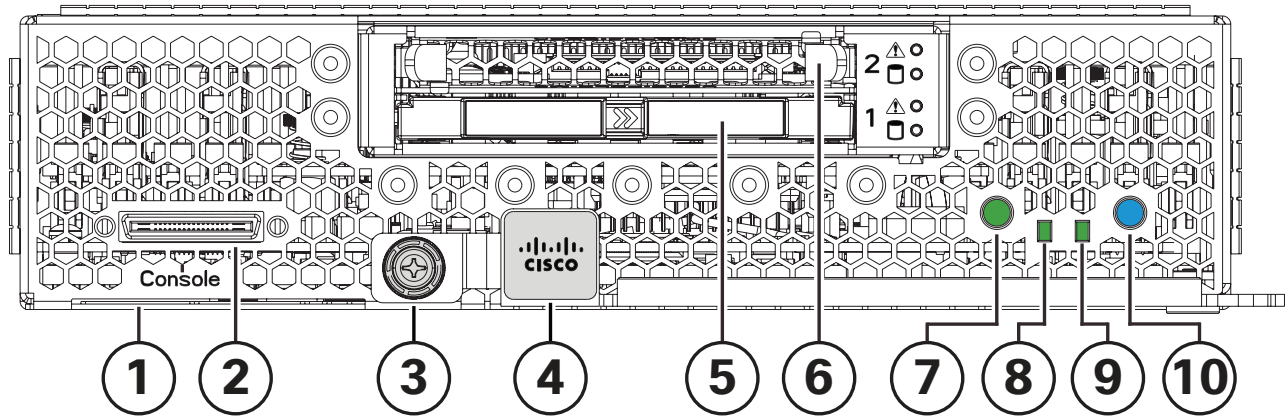

1	Asset pull tag Each server has a plastic tag that pulls out of the front panel. The tag contains the server serial number as well as the product ID (PID) and version ID (VID). The tag also allows you to add your own asset tracking label without interfering with the intended air flow.	6	Drive Bay 2(shown unpopulated)
2	Console connector ¹	7	Power button and LED
3	Ejector thumbscrew	8	Network link status LED
4	Blade ejector handle	9	Blade health LED
5	Drive bay 1 (shown populated)	10	Locate button and LED

Notes:

1. A KVM I/O cable plugs into the console connector, and can be ordered as a spare. The KVM I/O cable is included with every Cisco UCS 5100 Series blade server chassis accessory kit.

BASE SERVER STANDARD CAPABILITIES and FEATURES

Table 1 lists the capabilities and features of the base server. Details about how to configure the server for a listed feature or capability (for example, number of processors, disk drives, or amount of memory) are provided in *CONFIGURING the SERVER on page 7*

Table 1 Capabilities and Features

Capability/Feature	Description
Chassis	The UCS B200 M6 Blade Server mounts in a Cisco UCS 5108 Series blade server chassis or UCS Mini blade server chassis.
CPU	One or two 3rd Gen Intel® Xeon® Scalable Processors (Ice Lake). Also note that the B200 M6 Blade Server BIOS inherently enables support for Intel Advanced Encryption Standard New Instructions (AES-NI) and does not have an option to disable this feature.
Chipset	Intel® C621A series chipset (Lewisburg)
Memory	<ul style="list-style-type: none"> ■ 32 total DIMM slots ■ Support for Advanced ECC ■ Support for registered ECC DIMMs (RDIMMs) ■ Support for load-reduced DIMMs (LR DIMMs) ■ Support for PMem ■ Up to 4 TB GB DDR4 DIMM memory capacity (32 x 128 GB DIMMs) ■ Up to 10 TB memory with a mix of DIMMs and PMem <ul style="list-style-type: none"> • 16 x 128 GB DIMMs, and • 16 x 512 GB PMem
Modular LOM	One modular LOM (mLOM) connector at the rear of the blade for a Cisco mLOM VIC adapter, which provides Ethernet or Fibre Channel over Ethernet (FCoE) connectivity

Table 1 Capabilities and Features (*continued*)

Capability/Feature	Description
Mezzanine Adapters (Rear)	One rear mezzanine connector for <ul style="list-style-type: none"> ■ Cisco Mezzanine VIC Adapter, or ■ Cisco Mezzanine Port Expander
Mezzanine Adapters (Front)	One front mezzanine connector for <ul style="list-style-type: none"> ■ Cisco FlexStorage 12G RAID controller with two SAS/SATA SSD drives, or ■ Cisco FlexStorage NVMe pass-through module with two drives, or ■ Mini storage carrier with up to four M.2 SATA drives. UCS-M2-HWRAID is required when selecting the M.2 SATA drives.
Storage controller	For the front mezzanine connector: <ul style="list-style-type: none"> ■ Cisco FlexStorage 12G RAID controller module with drive bays ■ Cisco FlexStorage NVMe pass-through module with drive bays
Storage devices	Two front facing drive bays with choice of: <ul style="list-style-type: none"> ■ Up to two 2.5" SFF solid-state drives up to 7.6 TB capacity each ■ Up to two 2.5" PCIe NVMe drives up to 6.4 TB capacity each ■ Up to two HW-RAID modules, each with either one or two 240 GB or 960 GB M.2 SATA drives. UCS-M2-HWRAID is required when selecting the M.2 SATA drives.
Video	The Cisco Integrated Management Controller (CIMC) provides video using a Matrox G200e video/graphics controller. <ul style="list-style-type: none"> ■ Integrated 2D graphics core with hardware acceleration ■ DDR4 memory interface supports up to 512 MB of addressable memory (8 MB is allocated by default to video memory) ■ Supports display resolutions up to 1920 x 1200 32 bpp@ 60Hz ■ Single lane PCI-Express host interface running at Gen 2 speed
Interfaces	One KVM console connector on the front panel
Power subsystem	Integrated in the Cisco UCS 5108 blade server chassis
Fans	Integrated in the Cisco UCS 5108 blade server chassis.
Integrated management processor	The built-in Cisco Integrated Management Controller enables monitoring of server inventory, health, and system event logs
ACPI	Advanced Configuration and Power Interface (ACPI) 6.2 standard Supported.
UCSM	UCS Manager (UCSM) 4.2(1) or later runs in the Fabric Interconnect and automatically discovers and provisions some of the server components.
CIMC	Cisco Integrated Management Controller 4.2(1) or later

CONFIGURING the SERVER

Follow these steps to configure the Cisco UCS B200 M6 Blade Server:

- *STEP 1 CHOOSE BASE SERVER SKU, page 8*
- *STEP 2 CHOOSE CPU(S), page 9*
- *STEP 3 CHOOSE MEMORY, page 13*
- *STEP 4 CHOOSE MLOM REAR MEZZANINE ADAPTER, page 20*
- *STEP 5 CHOOSE OPTIONAL REAR MEZZANINE ADAPTERS (VIC or Port Expander), page 22*
- *STEP 6 CHOOSE OPTIONAL FRONT MEZZANINE ADAPTER, page 24*
- *STEP 7 CHOOSE OPTIONAL DRIVES, page 25*
- *STEP 8 CHOOSE TRUSTED PLATFORM MODULE, page 30*
- *STEP 9 CHOOSE UCSM SOFTWARE, page 31*
- *STEP 10 CHOOSE OPERATING SYSTEM AND VALUE-ADDED SOFTWARE, page 32*
- *STEP 11 CHOOSE OPTIONAL RECOVERY MEDIA, page 35*

STEP 1 CHOOSE BASE SERVER SKU

Verify the product ID (PID) of the server as shown in [Table 2](#).

Table 2 PID of the Base UCS B200 M6 Blade Server

Product ID (PID)	Description
UCS-M6-MLB	UCS M6 Rack, Blade MLB This major line bundle (MLB) consists of the Blade Server (UCSB-B200-M6) with software PIDs. Use this PID to begin a new configuration.
UCSB-B200-M6 ¹	UCS B200 M6 Blade Server without CPU, memory, drive bays, drives, VIC adapter, or mezzanine adapters (ordered as a blade chassis option)
UCSB-B200-M6-U ¹	UCS B200 M6 Blade Server without CPU, memory, drive bays, drives, VIC adapter, or mezzanine adapters (ordered standalone)

Notes:

1. This product may not be purchased outside of the approved bundles (must be ordered under the MLB)

A base Cisco UCS B200 M6 blade server ordered in [Table 2](#) does not include any components or options. They must be selected during product ordering.

Please follow the steps on the following pages to order components such as the following, which are required in a functional blade:

- CPUs
- Memory
- Cisco FlexStorage RAID controller with drive bays for SAS or SATA SSDs (or blank, for no local drive support)
- Cisco FlexStorage pass-through module with drive bays for PCIe NVMe drives)
- SSD, PCIe, or SATA M.2 drives (UCS-M2-HWRAID is required when selecting the M.2 SATA drives)
- Cisco adapters (such as the VIC 1440, VIC 1480, Port Expander)

STEP 2 CHOOSE CPU(S)

The standard CPU features are:

- 3rd Gen Intel® Xeon® Scalable Processors (Ice Lake)
- Intel® C621A series chipset
- Cache size of up to 60 MB
- Up to 40 cores

Select CPUs

The available CPUs are listed in [Table 3](#). See [Table 4 on page 11](#) for CPU suffix notations.

Table 3 Available CPUs

Product ID (PID)	Clock Freq (GHz)	Power (W)	Cache Size (MB)	Cores	UPI ¹ Links (GT/s)	Highest DDR4 DIMM Clock Support (MHz) ²	PMem Support
8000 Series Processors							
UCS-CPU-I8380	2.3	270	60	40	3 at 11.2	3200	Yes
UCS-CPU-I8368	2.4	270	57	38	3 at 11.2	3200	Yes
UCS-CPU-I8362	2.8	265	48	32	3 at 11.2	3200	Yes
UCS-CPU-I8360Y	2.4	250	54	36	3 at 11.2	3200	Yes
UCS-CPU-I8358P	2.6	240	48	32	3 at 11.2	3200	Yes
UCS-CPU-I8358	2.6	250	48	32	3 at 11.2	3200	Yes
UCS-CPU-I8352M	2.3	185	48	32	3 at 11.2	3200	Yes
UCS-CPU-I8352Y	2.2	205	48	32	3 at 11.2	3200	Yes
UCS-CPU-I8352V	2.1	195	54	36	3 at 11.2	2933	Yes
UCS-CPU-I8352S	2.2	205	48	32	3 at 11.2	3200	Yes
UCS-CPU-I8351N ³	2.4	225	54	36	0	2933	Yes
6000 Series Processors							
UCS-CPU-I6354	3.0	205	39	18	3 at 11.2	3200	Yes
UCS-CPU-I6348	2.6	235	42	28	3 at 11.2	3200	Yes
UCS-CPU-I6346	3.1	205	36	16	3 at 11.2	3200	Yes
UCS-CPU-I6342	2.8	230	36	24	3 at 11.2	3200	Yes
UCS-CPU-I6338N	2.2	185	48	32	3 at 11.2	2666	Yes
UCS-CPU-I6338T	2.1	165	36	24	3 at 11.2	3200	Yes
UCS-CPU-I6338	2.0	205	48	32	3 at 11.2	3200	Yes
UCS-CPU-I6336Y	2.4	185	36	24	3 at 11.2	3200	Yes
UCS-CPU-I6334	3.6	165	18	8	3 at 11.2	3200	Yes
UCS-CPU-I6330N	2.2	165	42	28	3 at 11.2	2666	Yes
UCS-CPU-I6330	2.0	205	42	28	3 at 11.2	2933	Yes

Table 3 Available CPUs

Product ID (PID)	Clock Freq (GHz)	Power (W)	Cache Size (MB)	Cores	UPI ¹ Links (GT/s)	Highest DDR4 DIMM Clock Support (MHz) ²	PMem Support
UCS-CPU-I6326	2.9	185	24	16	3 at 11.2	3200	Yes
UCS-CPU-I6314U ⁴	2.3	205	48	32	0	3200	Yes
UCS-CPU-I6312U ⁵	2.4	185	36	24	0	3200	Yes
5000 Series Processors							
UCS-CPU-I5320T	2.3	150	30	20	3 at 11.2	2933	Yes
UCS-CPU-I5320	2.2	185	39	26	3 at 11.2	2933	Yes
UCS-CPU-I5318N	2.1	150	36	24	3 at 11.2	2666	Yes
UCS-CPU-I5318S	2.1	165	36	24	3 at 11.2	2933	Yes
UCS-CPU-I5318Y	2.1	165	36	24	3 at 11.2	2933	Yes
UCS-CPU-I5317	3.0	150	18	12	3 at 11.2	2933	Yes
UCS-CPU-I5315Y	3.2	140	12	8	3 at 11.2	2933	Yes
4000 Series Processors							
UCS-CPU-I4316	2.3	150	30	20	2 at 10.4	2666	No
UCS-CPU-I4314	2.4	135	24	16	2 at 10.4	2666	Yes
UCS-CPU-I4310T	2.3	105	15	10	2 at 10.4	2666	No
UCS-CPU-I4310	2.1	120	18	12	2 at 10.4	2666	No
UCS-CPU-I4309Y	2.8	105	12	8	2 at 10.4	2666	No

Notes:

1. UPI = Ultra Path Interconnect.
2. If higher or lower speed DIMMs are selected than what is shown in [Table 6 on page 14](#) for a given CPU speed, the DIMMs will be clocked at the lowest common denominator of CPU clock and DIMM clock.
3. The maximum number of UCS-CPU-I8351N CPUs is one
4. The maximum number of UCS-CPU-I6314U CPUs is one
5. The maximum number of UCS-CPU-I6312U CPUs is one

Table 4 CPU Suffixes

CPU Suffix	Description	Features
N	Networking Optimized	Optimized for use in networking applications like L3 forwarding, 5G UPF, OVS DPDK, VPP FIB router, VPP IPsec, web server/NGINX, vEPC, vBNG, and vCMTS. SKUs have higher base frequency with lower TDPs to enable best performance/Watt
P	Cloud Optimized	SKU specifically designed for cloud IaaS environments to deliver higher frequencies at constrained TDPs
V	Cloud Optimized	SKUs specifically designed for cloud environments to deliver high rack density and maximize VM/cores per TCO\$
T	High T case	SKUs designed for Network Environment-Building System (NEBS) environments
U	1-socket Optimized	Optimized for targeted platforms adequately served by the cores, memory bandwidth and IO capacity available from a single processor
S	Max SGX enclave size	Supports Max SGX enclave size (512GB) to enhance and protect the most sensitive portions of a workload or service
M	Media and AI optimized	Media, AI and HPC Segment Optimized for lower TDP & higher frequencies delivering better perf/w
Y	Speed Select - Performance Profile	Intel® Speed Select Technology provides the ability to set a guaranteed base frequency for a specific number of cores, and assign this performance profile to a specific application/workload to guarantee performance requirements. It also provides the ability to configure settings during runtime and provide additional frequency profile configuration opportunities.

Supported Configurations

(1) DIMM only configurations:

- Select one or two identical CPUs listed in [Table 3 on page 9](#)

(2) DIMM/PMem Mixed Configurations:

- You must select two identical CPUs listed in [Table 3 on page 9](#)

(3) Configurations with NVMe PCIe drives:

- You must select two identical CPUs listed in [Table 3 on page 9](#)

(4) One-CPU Configuration

- Choose one CPU from any one of the rows of [Table 3 Available CPUs, page 9](#)

(5) Two-CPU Configuration

- Choose two identical CPUs from any one of the rows of [Table 3 Available CPUs, page 9](#)



NOTE:

- You cannot have two I8351N or two I6314U or I6312U CPUs in a two-CPU configuration.
- If you configure a server with one I8351N CPU or one I6314U CPU or one I6312U CPU you cannot later upgrade to a 2-CPU system with two of these CPUs.

Caveats

- The selection of 1 or 2 CPUs depends on the desired server functionality. See the following sections:
 - [STEP 3 CHOOSE MEMORY, page 13](#)
 - [STEP 7 CHOOSE OPTIONAL DRIVES, page 25](#)



CAUTION: In [Table 5](#), systems configured with the processors shown must adhere to the ambient inlet temperature thresholds specified. If not, a fan fault or executing workloads with extensive use of heavy instructions sets such as Intel® Advanced Vector Extensions 512 (Intel® AVX-512) may assert thermal and/or performance faults with an associated event recorded in the System Event Log (SEL). [Table 5](#) describes the configuration restrictions to ensure proper cooling and avoid excessive processor throttling, which may impact system performance.

Table 5 Ambient Temperature and Configuration Restrictions

Processor Thermal Design Power (TDP)	CPU Product ID (PID)	Blade Slot	Ambient Temperature Limit	Configuration Restrictions
Any	Any	Any	27 °C (80.6 °F)	None
Any	UCS-CPU-I6314U UCS-CPU-I8351N	Any	27 °C (80.6 °F)	Limited to single processor configurations

STEP 3 CHOOSE MEMORY

The available memory for the B200 M6 is as follows:

- Clock speed: 3200 MHz
- Ranks per DIMM: 1, 2, 4, or 8
- Operational voltage: 1.2 V
- Registered ECC DDR4 DIMMs (RDIMMs), Load-reduced DIMMs (LRDIMMs), or Intel® Optane™ Persistent Memory Modules (PMem).

Memory is organized with eight memory channels per CPU, with up to two DIMMs per channel, as shown in [Figure 3](#)

Figure 3 B200 M6 Memory Organization

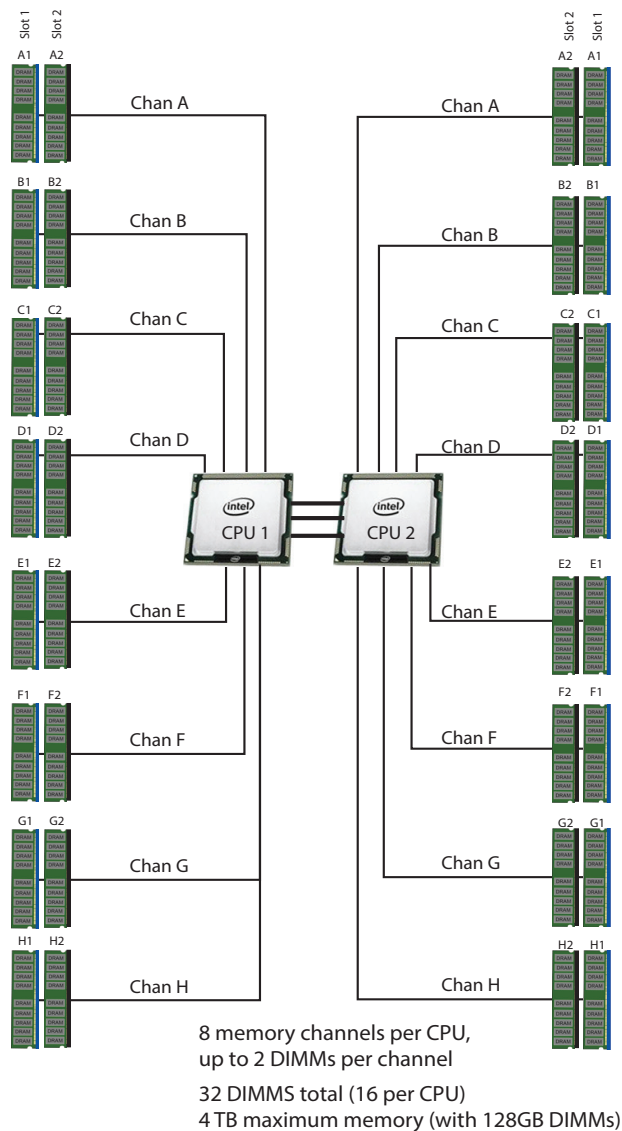

Choose DIMMs and Memory Mirroring

Select the memory configuration and whether or not you want the memory mirroring option. The supported memory DIMMs, PMem, PMem Memory Modes, and the mirroring option are listed in [Table 6](#).

Table 6 Available DDR4 DIMMs and PMem

Product ID (PID)	PID Description	Voltage	Ranks /DIMM
DIMMs			
UCS-MR-X16G1RW	16 GB RDIMM SRx4 3200 (8Gb)	1.2 V	1
UCS-MR-X32G1RW	32 GB RDIMM SRx4 3200 (16Gb)	1.2 V	1
UCS-MR-X32G2RW	32 GB RDIMM DRx4 3200 (8Gb)	1.2 V	2
UCS-MR-X64G2RW	64 GB RDIMM DRx4 3200 (16Gb)	1.2 V	2
UCS-ML-128G4RW	128 GB LRDIMM QRx4 3200 (16Gb) (non-3DS)	1.2 V	4
Intel® Optane™ Persistent Memory Product (PMem)¹			
UCS-MP-128GS-B0	Intel® Optane™ Persistent Memory, 128GB, 3200 MHz		
UCS-MP-256GS-B0	Intel® Optane™ Persistent Memory, 256GB, 3200 MHz		
UCS-MP-512GS-B0	Intel® Optane™ Persistent Memory, 512GB, 3200 MHz		
DIMM Blank²			
UCS-DIMM-BLK	UCS DIMM Blank		
Intel® Optane™ Persistent Memory (PMem) Operational Modes			
UCS-DCPMM-AD	App Direct Mode		
UCS-DCPMM-MM	Memory Mode		
Memory Mirroring Option³			
N01-MMIRROR	Memory mirroring option		

Notes:

1. All 3rd Generation Intel® Xeon® Scalable Processors (Ice Lake) support PMem products, except 4309Y, 4310, 4310T, and 4316 processor.
2. Any empty DIM M slot must be populated with a DIMM blank to maintain proper cooling airflow.
3. For Memory Configuration and Mirroring, please refer to [Memory Configuration and Mirroring on page 46](#) and [Memory Support for 3rd Generation Intel® Xeon® Scalable Processors \(Ice Lake\) on page 49](#).

Memory Configurations, Features, and Modes

System speed is dependent on the CPU DIMM speed support. Refer to [Available CPUs on page 9](#) for DIMM speeds.

- DIMMs for CPU 1 and CPU 2 (when populated) must always be configured identically.
- Cisco memory from previous generation servers (DDR3 and DDR4) is not compatible with the UCS B200 M6 Blade.
- Memory can be configured in any number of DIMMs as pairs, although for optimal performance, refer to the [Cisco UCS C220/C240/B200 M6 Memory Guide](#).
- For additional information, refer to [Memory Configuration and Mirroring on page 46](#).
- For detailed Intel® Optane™ Persistent Memory (PMem) configurations, refer to the [B200 M6 Server Installation and Service Guide](#).

Approved Configurations



NOTE: Memory mirroring is allowed only with DIMMs; no memory mirroring can be configured if PMem are installed.

(1) 1-CPU configuration without memory mirroring:

- Select from 1 to 16 DIMMs.
 - 1, 2, 4, 6, 8, 12, or 16 DIMMs allowed
 - 3, 5, 7, 9, 10, 11, 13, 14, 15 DIMMs not allowed
 - DIMMs for both CPUs must be configured identically.

The DIMMs will be placed by the factory as shown in the following table.

#DIMMs	CPU 1 DIMM Placement in Channels (for identically ranked DIMMs)
1	(A1)
2	(A1, E1)
4	(A1, C1); (E1, G1)
6	(A1, C1); (D1, E1); (G1, H1)
8	(A1, C1); (D1, E1); (G1, H1); (B1, F1)
12	(A1, C1); (D1, E1); (G1, H1); (A2, C2); (D2, E2); (G2, H2)
16	(A1, B1); (C1, D1); (E1, F1); (G1, H1); (A2, B2); (C2, D2); (E2, F2); (G2, H2)

(2) 1-CPU configuration with memory mirroring:

- Select 8 or 16 DIMMs per CPU (DIMMs for all CPUs must be configured identically). In addition, the memory mirroring option (N01-MMIRROR) as shown in [Table 6 on page 14](#) must be selected.

The DIMMs will be placed by the factory as shown in the following table.

# DIMMs Per CPU	CPU 1 DIMM Placement in Channels (for identical ranked DIMMs)
8	(A1, C1); (D1, E1); (G1, H1); (B1, F1)
16	(A1, B1); (C1, D1); (E1, F1); (G1, H1); (A2, B2); (C2, D2); (E2, F2); (G2, H2)

- Select the memory mirroring option (N01-MMIRROR) as shown in [Table 6 on page 14](#).

(3) 2-CPU configuration without memory mirroring:

- Select from 1 to 16 DIMMs per CPU.
 - 1, 2, 4, 6, 8, 12, or 16 DIMMs allowed
 - 3, 5, 7, 9, 10, 11, 13, 14, 15 DIMMs not allowed
 - DIMMs for both CPUs must be configured identically.

The DIMMs will be placed by the factory as shown in the following tables.

#DIMMs	CPU 1 DIMM Placement in Channels (for identically ranked DIMMs)	CPU 2 DIMM Placement in Channels (for identically ranked DIMMs)
1	(A1)	(A1)
2	(A1, E1)	(A1, E1)
4	(A1, C1); (E1, G1)	(A1, C1); (E1, G1)
6	(A1, C1); (D1, E1); (G1, H1)	(A1, C1); (D1, E1); (G1, H1)
8	(A1, C1); (D1, E1); (G1, H1); (B1, F1)	(A1, C1); (D1, E1); (G1, H1); (B1, F1)
12	(A1, C1); (D1, E1); (G1, H1); (A2, C2); (D2, E2); (G2, H2)	(A1, C1); (D1, E1); (G1, H1); (A2, C2); (D2, E2); (G2, H2)
16	(A1, B1); (C1, D1); (E1, F1); (G1, H1); (A2, B2); (C2, D2); (E2, F2); (G2, H2)	(A1, B1); (C1, D1); (E1, F1); (G1, H1); (A2, B2); (C2, D2); (E2, F2); (G2, H2)

(4) 2-CPU configuration with memory mirroring:

- Select 8 or 16 DIMMs per CPU (DIMMs for all CPUs must be configured identically). In addition, the memory mirroring option (N01-MMIRROR) as shown in [Table 6 on page 14](#) must be selected.

The DIMMs will be placed by the factory as shown in the following tables.

# DIMMs Per CPU	CPU 1 DIMM Placement in Channels (for identical ranked DIMMs)	CPU 2 DIMM Placement in Channels (for identically ranked DIMMs)
8	(A1, C1); (D1, E1); (G1, H1); (B1, F1)	(A1, C1); (D1, E1); (G1, H1); (B1, F1)
16	(A1, B1); (C1, D1); (E1, F1); (G1, H1); (A2, B2); (C2, D2); (E2, F2); (G2, H2)	(A1, B1); (C1, D1); (E1, F1); (G1, H1); (A2, B2); (C2, D2); (E2, F2); (G2, H2)

- Select the memory mirroring option (N01-MMIRROR) as shown in [Table 6 on page 14](#).



NOTE: System performance is optimized when the DIMM type and quantity are equal for both CPUs, and when all channels are filled equally across the CPUs in the server.

Table 7 3200-MHz DIMM Memory Speeds with Different Intel® Xeon® Ice Lake® Processors

DIMM and CPU Frequencies (MHz)	DPC	LRDIMM (4Rx4)- 128 GB (MHz)	RDIMM (2Rx4) - 64 GB (MHz)	RDIMM (2Rx4) - 32 GB (MHz)	RDIMM (1Rx4) - 16 GB (MHz)
		1.2 V	1.2 V	1.2 V	1.2 V
DIMM = 3200 CPU = 3200	1DPC	3200	3200	3200	3200
	2DPC	3200	3200	3200	3200
DIMM = 3200 CPU = 2933	1DPC	2933	2933	2933	2933
	2DPC	2933	2933	2933	2933
DIMM = 3200 CPU = 2666	1DPC	2666	2666	2666	2666
	2DPC	2666	2666	2666	2666

DIMM Rules

- Allowed DIMM count for 1 CPU:
 - Minimum DIMM count = 1; Maximum DIMM count = 16
 - 1, 2, 4, 6, 8, 12, or 16 DIMMs allowed
 - 3, 5, 7, 9, 10, 11, 13, 14, or 15 DIMMs not allowed.
- Allowed DIMM count for 2 CPUs
 - Minimum DIMM count = 2; Maximum DIMM count = 32
 - 2, 4, 8, 12, 16, 24, or 32 DIMMs allowed
 - 6, 10, 14, 18, 20, 22, 26, 28, or 30 DIMMs not allowed.
- DIMM Mixing:
 - Mixing different types of DIMM (RDIMM with LRDIMM) is not supported within a server.
 - Mixing RDIMM with RDIMM types is allowed if they are mixed in same quantities, in a balanced configuration.
 - Mixing 16GB, 32GB, and 64GB RDIMMs is supported.
 - 128GB LRDIMMs cannot be mixed with other RDIMMs.



NOTE:

- DIMM mixing is not allowed when PMem are installed; in these cases, all DIMMs must be the same type and size.
- See the detailed mixing DIMM configurations at the following link

[Cisco UCS C220/C240/B200 M6 Memory Guide](#)

See [Table 8](#) for PMem memory modes. See [Table 8](#) for allowed DIMM/PMem mixed configurations.

Table 8 Intel® Optane™ Persistent Memory Modes

Intel® Optane™ Persistent Memory Modes	
App Direct Mode	PMem operates as a solid-state disk storage device. Data is saved and is non-volatile. Both DCPMM and DIMM capacities count towards the CPU capacity limit.
Memory Mode	PMem operates as a 100% memory module. Data is volatile and DRAM acts as a cache for PMem. Only the PMem capacity counts towards the CPU capacity limit). This is the factory default mode.

Table 9 3rd Gen Intel® Xeon® Scalable Processors (Ice Lake) Allowable Mixed DIMM/PMem¹ Physical Configuration (per socket)

DIMM + PMem Count	CPU 1 or CPU 2															
	ICX: IMC2				ICX: IMC3				ICX: IMC1				ICX: IMC0			
	Chan 0 (F)		Chan 1 (E)		Chan 0 (H)		Chan 1 (G)		Chan 0 (C)		Chan 1 (D)		Chan 0 (A)		Chan 1 (B)	
	Slot 1	Slot 2	Slot 1	Slot 2	Slot 1	Slot 2	Slot 1	Slot 2	Slot 2	Slot 1	Slot 2	Slot 1	Slot 2	Slot 1	Slot 2	Slot 1
4 + 4 ²	PMem		DIMM		PMem		DIMM			DIMM		PMem		DIMM		PMem
8 + 1 ³	DIMM		DIMM		DIMM		DIMM			DIMM		DIMM	PMem	DIMM		DIMM
8 + 4 ⁴	DIMM		DIMM	PMem	DIMM		DIMM	PMem	PMem	DIMM		DIMM	PMem	DIMM		DIMM
8 + 8 ⁵	DIMM	PMem	DIMM	PMem	DIMM	PMem	DIMM	PMem	PMem	DIMM	PMem	DIMM	PMem	DIMM	PMem	DIMM

NOTE: AD = App Direct Mode, MM = Memory Mode

Notes:

1. All systems must be fully populated with two CPUs when using PMem at this time.
2. AD, MM
3. AD
4. AD, MM
5. AD, MM

For detailed Intel PMem configurations, refer to the Cisco UCS B200 M6 Server Installation and Service Guide.

[Cisco UCS B200 M6 Server Installation and Service Guide](#)

For detailed DIMM/PMem informations, refer the UCS C220/C240/B200 M6 Memory Guide.

[Cisco UCS C220/C240/B200 M6 Memory Guide](#)

STEP 4 CHOOSE MLOM REAR MEZZANINE ADAPTER

The UCS B200 M6 must be ordered with a Cisco VIC mLOM Adapter. The adapter can operate in a single-CPU or dual-CPU configuration. [Table 11](#) shows available mLOM adapter choices.

Table 10 mLOM Adapters

Product ID (PID)	Description	Connector
UCSB-MLOM-40G-04	Cisco UCS VIC 1440 modular LOM for blade servers	mLOM
UCSB-ML-V5Q10G	Cisco UCS VIC 15411 modular LOM for Blade Servers	mLOM

Table 11 Aggregate Bandwidth with mLOM Only configuration

mLOM	Fabrics Extenders in UCS 5108 blade chassis aggregate bandwidth (Gb/s)									
	2x 2408	2x 2304	2x2208XP	2x2204XP	2 x 6324	2 x 6332	2 x 6332-16UP	2 x 6454	2 x 64108	2 x 6536
VIC 1440 mLOM	40	40	40	20	Yes (20 Gbps)	Yes	Yes	Yes	Yes	Yes
VIC 15411 mLOM	40	40	40	20	No	Yes	Yes	Yes	Yes	Yes

Cisco developed the 1400 Series and 15411 Virtual Interface Card (VIC) to provide flexibility to create multiple NIC and HBA devices. The VIC features are listed here:

- Includes enhancements, including network overlay offload support.
- Provides two Converged Network Adapter (CNA) ports, supporting both Ethernet and FCoE
- Delivers up to 80 Gbps total I/O throughput to the server
- Supports 2x40 (native) Gbps Unified I/O ports
- Supports up to 256 fully functional unique and independent PCIe adapters and interfaces
- Provides virtual machine visibility from the physical network and a consistent network operations model for physical and virtual servers
- Supports customer requirements for a wide range of operating systems and hypervisors

The mLOM VIC on the UCS B200 M6 enables connectivity to the Fabric Interconnect either through the Fabric Extenders (FEX) or directly using the UCS 6324 Fabric Interconnect (UCS Mini) on the UCS 5108 Blade Chassis.

The supported Fabric Extenders for the B200 M6 blades are

- Cisco UCS 2200 series Fabric Extenders
- Cisco UCS 2304 (v1) Fabric Extender
- Cisco UCS 2304 (v2) Fabric Extender
- Cisco UCS 2408 Fabric Extenders

The supported Fabric Interconnects for the B200 M6 blades are

- Cisco UCS 6300 series Fabric Interconnects
- Cisco UCS 6400 series Fabric Interconnects
- Cisco UCS 6536 Fabric Interconnect

STEP 5 CHOOSE OPTIONAL REAR MEZZANINE ADAPTERS (VIC or Port Expander)

The UCS B200 M6 has one rear mezzanine adapter connector. The UCS B200 M6 can be ordered with or without a rear mezzanine adapter. Refer to [Table 12 Available Rear Mezzanine Adapters](#) for supported adapters.

Table 12 Available Rear Mezzanine Adapters

Product ID(PID)	PID Description	CPUs Required	Connector
Port Expander Card for VIC			
This is a hardware option to enable an additional 4 ports of the VIC 1440, bringing the total capability of the VIC 1440 to a dual native 40G interface.			
UCSB-MLOM-PT-01	Cisco UCS Port Expander Card for VIC	1 or 2 CPUs	Rear Mezzanine
Cisco VIC Card			
UCSB-VIC-M84-4P	Cisco UCS VIC 1480 mezzanine adapter	2 CPUs required	Rear Mezzanine

Supported Configurations

- Requires an mLOM (VIC 1440)

See [Table 13](#) for aggregate bandwidths with various rear mezzanine cards installed.

Table 13 Aggregate Bandwidth with Rear Mezzanine Cards Installed

Rear Mezz Adapter	Fabric Extenders in UCS5108 blade chassis Aggregate Bandwidth (Gb/s)				Fabric Interconnects Support					
	2x 2408	2x 2304	2x 2208XP	2x 2204XP	2 x 6324	2 x 6332	2 x 6332-16UP	2 x 6454	2 x 64108	2 x 6536 ⁵
1440+ Port Expander	80 ¹	80 ^{2, 3}	40	20	Yes (20 Gbps)	Yes	Yes	Yes	Yes	Yes
VIC 1480	80 ⁴	80 ⁴	80 ⁴	40	Yes (40 Gbps)	Yes	Yes	Yes	Yes	Yes
VIC 15411 + Port Expander	80 ¹	80 ^{2,3}	40	20	No	Yes	Yes	Yes	Yes	Yes

Notes:

1. Uses a dual native 40G interface. The maximum single-flow is 25 Gbps with an aggregate of 40 Gbps. To avoid IOM/Fabric Extender transient drops due to a speed mismatch of 40 Gbps towards the server and 25 Gbps towards the fabric interconnect (FI), vNIC rate-limiting to 25 Gbps is recommended
2. Uses a dual native 40G interface
3. If operating in 4 x 10 mode, bandwidth drops down to 40 Gbps (two 2 x 10 G port-channelled)

4. Four 2x10 Gbps port-channels
5. The Cisco UCS 6536 Fabric Interconnect and/or VIC 1440 is supported with Intersight Managed Mode from 4.2(2) or greater and the UCSM support for FI 6536 is available with 4.2(3) release. The FI 6536 supported only IOM- 2408 in 4.2(2) release and from 4.2(3) release supports both IOM-2408 and IOM-2304.
6. VIC 15411 is supported from 4.2(3) release in UCSM & IMM. 15411 is supported with M6 blades and with FI-6332/6332-16UP/6454/64108/6536 with IOM 220x/2304/2408.
7. B200-M6 is supported only on the primary chassis with FI-6324 or UCS Mini.

STEP 6 CHOOSE OPTIONAL FRONT MEZZANINE ADAPTER

The UCS B200 M6 has one front mezzanine connector that can accommodate one of the following mezzanine cards:

- Cisco FlexStorage 12G RAID controller with 2 drive bays, or
- Cisco FlexStorage Pass-through module with 2 drive bays, or
- Cisco FlexStorage Mini Storage carrier for SATA M.2 RAID storage. UCS-M2-HWRAID is required when selecting the M.2 SATA drives.

The UCS B200 M6 can be ordered with or without the front mezzanine adapter. Refer to [Table 14 Available Front Mezzanine Adapters](#).

Table 14 Available Front Mezzanine Adapters

Product ID(PID)	PID Description	Connector Type
UCSB-RAID12G-M6	Cisco FlexStorage 12G RAID controller with drive bays for two SAS/SATA solid state drives (SSDs).	Front Mezzanine
UCSB-LSTOR-PT-M6	Cisco FlexStorage pass-through module with drive bays for two PCIe NVMe drives.	Front Mezzanine
UCSB-MSTOR-M6 ¹	Mini storage carrier that holds up to two SATA M.2 RAID cards.	Front Mezzanine

Notes:

1. The B200 M6 can accommodate one UCSB-MSTOR-M6 mini-storage carrier. The carrier can hold up to two UCS-M2-HWRAID boot-optimized RAID controllers (see [Cisco 6GB/s SATA Boot-Optimized M.2 RAID Controller on page 28](#)). Up to two UCS-M2-240GB or UCS-M2-960GB SATA M.2 drive cards plug into each UCS-M2-HWRAID, so you can have a maximum of four SATA M.2 cards. The SATA M.2 cards plugged into the same UCS-M2-HWRAID RAID controller must be the same capacity.

STEP 7 CHOOSE OPTIONAL DRIVES

The UCS B200 M6 can be ordered with or without drives. The drive options are:

- One or two 2.5-inch (7 mm) small form factor SSDs or PCIe NVMe drives
 - Hot-pluggable
 - Sled-mounted
- Up to two SATA M.2 storage modules can be selected to be plugged into each UCS-M2-HWRAID module, which is then plugged into the UCSB-MSTOR-M6 mini storage carrier. Two SATA M.2 storage modules in the same UCS-M2-HWRAID module must be the same capacity.

Select one or two drives from the list of supported drives available in [Table 15](#).

Table 15 Available Drive Options

Product ID (PID)	Description	Drive Type	Speed	Performance /Endurance /Value	Size
SATA SSDs^{1,2,3}					
Enterprise Performance SSDs (high endurance, supports up to 3X DWPD (drive writes per day))					
UCS-SD480GBI6-EP	480 GB 2.5in Enterprise performance 6G SATA SSD (3X endurance) Intel S4610	SATA	6G	Ent. Perf 3X	480 GB
UCS-SD960GBI6-EP	960 GB 2.5in Enterprise performance 6G SATA SSD (3X endurance) Intel S4610	SATA	6G	Ent. Perf 3X	960 GB
UCS-SD19TBI6-EP	1.9 TB 2.5in Enterprise performance 6G SATA SSD (3X endurance) Intel S4610	SATA	6G	Ent. Perf 3X	1.9 TB
UCS-SD480GBM6-EP	480 GB 2.5in Enterprise performance 6G SATA SSD (3X endurance) Micron 5300	SATA	6G	Ent. Perf 3X	480 GB
UCS-SD960GBM6-EP	960 GB 2.5in Enterprise performance 6G SATA SSD (3X endurance) Micron 5300	SATA	6G	Ent. Perf 3X	960 GB
UCS-SD19TM6-EP	1.9 TB 2.5in Enterprise performance 6G SATA SSD (3X endurance) Micron 5300	SATA	6G	Ent. Perf 3X	1.9 TB
UCS-SD19TBM6-EP	1.9TB Enterprise value SATA SSD (1X , SED)	SATA	6G	Ent. Perf 1X	1.9 TB
UCS-SD960GM6-EP	960GB 2.5in Enterprise performance 6GSATA SSD(3X endurance)	SATA	6G	Ent. Perf 3X	960 GB
UCS-SD480GM6-EP	480GB 2.5in Enterprise performance 6GSATA SSD(3X endurance)	SATA	6G	Ent. Perf 3X	480 GB

Table 15 Available Drive Options (continued)

Product ID (PID)	Description	Drive Type	Speed	Performance /Endurance /Value	Size
Enterprise Value SSDs (Low endurance, supports up to 1X DWPD (drive writes per day))					
UCS-SD120GM6-EV	120 GB 2.5 inch Enterprise Value 6G SATA SSD Micron 5300	SATA	6G	Ent. Value	120 GB
UCS-SD240GM6-EV	240 GB 2.5 inch Enterprise Value 6G SATA SSD Micron 5300	SATA	6G	Ent. Value	240 GB
UCS-SD480GI6-EV	480 GB 2.5 inch Enterprise Value 6G SATA SSD Intel S4510	SATA	6G	Ent. Value	480 GB
UCS-SD960GI6-EV	960 GB 2.5 inch Enterprise Value 6G SATA SSD Intel S4510	SATA	6G	Ent. Value	960 GB
UCS-SD16TM6-EV	1.6 TB 2.5 inch Enterprise Value 6G SATA SSD Micron 5300	SATA	6G	Ent. Value	1.6 TB
UCS-SD19TM6-EV	1.9 TB 2.5 inch Enterprise Value 6G SATA SSD Micron 5300	SATA	6G	Ent. Value	1.9 TB
UCS-SD38TM6-EV	3.8 TB 2.5 inch Enterprise Value 6G SATA SSD Micron 5300	SATA	6G	Ent. Value	3.8 TB
UCS-SD38TI6-EV	3.8 TB 2.5 inch Enterprise Value 6G SATA SSD Intel S4510	SATA	6G	Ent. Value	3.8 TB
UCS-SD76TM6-EV	7.6 TB 2.5 inch Enterprise Value 6G SATA SSD Micron 5300	SATA	6G	Ent. Value	7.6 TB
UCS-SD960GS6-EV	960 GB 2.5 inch Enterprise Value 6G SATA SSD Samsung PM883	SATA	6G	Ent. Value	960 GB
UCS-SD19TS6-EV	1.9 TB 2.5 inch Enterprise Value 6G SATA SSD Samsung PM883	SATA	6G	Ent. Value	1.9 TB
UCS-SD38TS6-EV	3.8 TB 2.5 inch Enterprise Value 6G SATA SSD Samsung PM883	SATA	6G	Ent. Value	3.8 TB
UCS-SD480GM6-EV	480 GB 2.5 inch Enterprise Value 6G SATA SSD Micron 5300	SATA	6G	Ent. Value	480 GB
UCS-SD960GM6-EV	960 GB 2.5 inch Enterprise Value 6G SATA SSD Micron 5300	SATA	6G	Ent. Value	960 GB
UCS-SD960GS26-EV	960GB 2.5 inch Enterprise Value 6G SATA SSD	SATA	6G	Ent. Value	960 GB
UCS-SD19TS26-EV	1.9TB 2.5 inch Enterprise Value 6G SATA SSD	SATA	6G	Ent. Value	1.9 TB
UCS-SD38TS26-EV	3.8TB 2.5 inch Enterprise Value 6G SATA SSD	SATA	6G	Ent. Value	3.8 TB
UCS-SD78TS26-EV	7.6TB 2.5 inch Enterprise Value 6G SATA SSD	SATA	6G	Ent. Value	7.6 TB

NVMe⁴

Table 15 Available Drive Options (continued)

Product ID (PID)	Description	Drive Type	Speed	Performance /Endurance /Value	Size
UCSB-NVMEM6-W800	800 GB 2.5in U.2 Western Digital SN640 NVMe Med Perf. High Endurance	NVMe	U.2	Med. Perf High End.	800 GB
UCSB-NVMEM6-W1920	1.9 TB 2.5in U.2 Western Digital SN640 NVMe Med Perf. Value Endurance	NVMe	U.2	Med Perf Value End.	1.9 TB
UCSB-NVMEM6-W3800	3.8 TB 2.5in U.2 Western Digital SN640 NVMe Med Perf. Value Endurance	NVMe	U.2	Med Perf Value End.	3.8 TB
UCSB-NVMEM6-W6400	6.4 TB 2.5in U.2 Western Digital SN640 NVMe Med Perf. High Endurance	NVMe	U.2	Med. Perf High End.	6.4 TB
UCSB-NVMEM6-M7600	7.6TB 2.5in U.3 7mm Micron 7450 Hg Perf Med End NVMe (1X)	NVMe	U.3	Med. Perf High End.	7.6 TB
Self-Encrypted Drives (SED)					
UCS-SD38TBM6NK9	3.8TB Enterprise Value SATA SSD (1X, SED)	SED		Ent. Value	3.8 TB
UCS-SD76TBM6NK9	7.6TB Enterprise Value SATA SSD (1X, SED)	SED		Ent. Value	7.6 TB
SATA M.2 Storage Modules⁵					
UCS-M2-240GB	Micron 5100 240 G SATA M.2	SATA	M.2		240 GB
UCS-M2-960GB	Micron 5100 960 G SATA M.2	SATA	M.2		960 GB
NOTE: Cisco uses solid state drives (SSDs) from a number of vendors. All solid state drives (SSDs) are subject to physical write limits and have varying maximum usage limitation specifications set by the manufacturer. Cisco will not replace any solid state drives (SSDs) that have exceeded any maximum usage specifications set by Cisco or the manufacturer, as determined solely by Cisco.					

Notes:

1. SSD drives require the UCSB-MRAID-M6 front mezzanine adapter
2. For SSD drives to be in a RAID group, two identical SSDs must be used in the group.
3. If SSDs are in JBOD Mode, the drives do not need to be identical.
4. NVMe drives require the UCSB-LSTOR-PT front mezzanine adapter
5. UCS-M2-HWRAID is needed with M.2 Storage Modules.

Cisco 6GB/s SATA Boot-Optimized M.2 RAID Controller

If you order M.2 SATA drives, you must select the boot-optimized RAID controller (UCS-M2-HWRAID) for hardware RAID across each one or two SATA M.2 drives. You must also select one UCSB-MSTOR-M6 mini storage carrier. The RAID controller plugs into the UCSB-MSTOR-M6 mini-storage carrier and up to two SATA M.2 drives plug into the UCS-M2-HWRAID RAID controller.

Note: The Boot-Optimized RAID controller supports VMWare, Windows and Linux Operating Systems.

Table 16 Boot-Optimized RAID controller

Product ID (PID)	PID Description
UCS-M2-HWRAID	Cisco Boot optimized M.2 RAID controller



NOTE:

- The UCS-M2-HWRAID controller supports RAID 1 and JBOD mode and is available only with 240 GB and 960 GB M.2 SATA SSDs.
- (CIMC/UCSM) is supported for configuring of volumes and monitoring of the controller and installed SATA M.2 drives
- The minimum version of Cisco IMC and Cisco UCS Manager that support the controller is 4.0(4) and later. The name of the controller in the software is MSTOR-RAID
- The SATA M.2 drives can boot in UEFI mode only. Legacy boot mode is not supported
- Hot-plug replacement is not supported. The server must be powered off.

Intel® Virtual RAID on CPU (Intel® VROC)

The server supports Intel® Virtual RAID on CPU (Intel® VROC). VROC is an enterprise RAID solution used with Intel NVMe SSDs (see [Table 15](#) for supported Intel NVMe SSDs). The Intel® Volume Management Device (Intel® VMD) is a controller integrated into the CPU PCIe root complex. Intel® VMD NVMe SSDs are connected to the CPU, which allows the full performance potential of fast Intel® Optane™ SSDs to be realized. Intel® VROC, when implemented, replaces traditional hardware RAID host bus adapter (HBA) cards placed between the drives and the CPU.

**NOTE:**

- Intel® VROC is only supported with Intel drives
 - Intel® VROC enablement key factory pre-provisioned to BIOS - no additional licensing required.
-

VROC has the following features:

- Small Form Factor (SFF) drive support (only)
- No battery backup (BBU) or external SuperCap needed
- Software-based solution utilizing Intel SFF NVMe direct connected to Intel CPU
- RAID 0/1/5/10 support
- Windows, Linux, VMware OS support.
- Host Tools- Windows GUI/CLI, Linux CLI.
- UEFI Support- HII Utility, OBSE.
- Intel VROC NVMe operates in UEFI mode only

See the [instructions on setting up and managing VROC for Intel NVMe SSDs](#) for more information.

STEP 8 CHOOSE TRUSTED PLATFORM MODULE

Trusted Platform Module (TPM) is a computer chip or microcontroller that can securely store artifacts used to authenticate the platform or server. These artifacts can include passwords, certificates, or encryption keys. A TPM can also be used to store platform measurements that help ensure that the platform remains trustworthy. Authentication (ensuring that the platform can prove that it is what it claims to be) and attestation (a process helping to prove that a platform is trustworthy and has not been breached) are necessary steps to ensure safer computing in all environments.

Table 17 Available TPM Option

Product ID (PID)	Description
UCSX-TPM-002C	Trusted Platform Module 2.0, FIPS140-2 Compliant, UCS M6 svr
UCSX-TPM-OPT-OUT	OPT OUT, TPM 2.0, TCG, FIPS140-2, CC EAL4+ Certified ¹

Notes:

1. Please note that Microsoft certification requires a TPM 2.0 for bare-metal or guest VM deployments. Opt-out of the TPM 2.0 voids the Microsoft certification



NOTE:

- The TPM module used in this system conforms to TPM v2.0 as defined by the Trusted Computing Group (TCG).
- TPM installation is supported after-factory. However, a TPM installs with a one-way screw and cannot be replaced, upgraded, or moved to another server. If a server with a TPM is returned, the replacement server must be ordered with a new TPM. If there is no existing TPM in the server, you can install TPM 2.0. Refer to the following document for Installation location and instructions: [Cisco UCS B200 M6 Server Installation Guide](#).

STEP 9 CHOOSE UCSM SOFTWARE

A UCSM software version needs to be selected for the standalone UCS B200 M6 Blade PID (UCSB-B200-M6-UPG).



NOTE:

- This is a new mandatory option for standalone blades starting with the UCS B200 M6.
- When the UCS B200 M6 is configured inside of a chassis in the CCW ordering tool, the UCSM software version is selected at the chassis level. The software option will not be available under the UCS B200 M6 in that case.
- The recommended UCS releases for the UCS B200 M6 is UCSM 4.2(1). This release supports higher wattage CPUs. FI 6454 and/or VIC 1400 require release UCSM 4.0(1) or greater.

Choose one software PID from [Table 18](#).

Table 18 Available UCSM Software

Product ID (PID)	Product Description	Software Version
N20-FW018	UCS 5108 Blade Chassis FW Package 4.2	UCSM 4.2

STEP 10 CHOOSE OPERATING SYSTEM AND VALUE-ADDED SOFTWARE



NOTE: See this link for operating system guidance:
<https://ucshcltool.cloudapps.cisco.com/public/>

For more details on supported operating systems and software for this server, see the Hardware and Software Compatibility List (HCL)

Select

- OEM Software ([Table 19](#))
- Operating System ([Table 20](#))

Table 19 OEM Software

Product ID (PID)	PID Description
VMware vCenter	
VMW-VCS-STD-1A	VMware vCenter 6 Server Standard, 1 yr support required
VMW-VCS-STD-3A	VMware vCenter 6 Server Standard, 3 yr support required
VMW-VCS-STD-5A	VMware vCenter 6 Server Standard, 5 yr support required
VMW-VCS-FND-1A	VMware vCenter 6 Server Foundation (4 Host), 1 yr supp reqd
VMW-VCS-FND-3A	VMware vCenter 6 Server Foundation (4 Host), 3 yr supp reqd
VMW-VCS-FND-5A	VMware vCenter 6 Server Foundation (4 Host), 5 yr supp reqd

Table 20 Operating System

Product ID (PID)	PID Description
Microsoft Windows Server	
MSWS-19-DC16C	Windows Server 2019 Data Center (16 Cores/Unlimited VMs)
MSWS-19-DC16C-NS	Windows Server 2019 DC (16 Cores/Unlim VMs) - No Cisco SVC
MSWS-19-ST16C	Windows Server 2019 Standard (16 Cores/2 VMs)
MSWS-19-ST16C-NS	Windows Server 2019 Standard (16 Cores/2 VMs) - No Cisco SVC
MSWS-22-DC16C	Windows Server 2022 Data Center (16 Cores/Unlimited VMs)

Table 20 Operating System (continued)

Product ID (PID)	PID Description
MSWS-22-DC16C-NS	Windows Server 2022 DC (16 Cores/Unlim VMs) - No Cisco SVC
MSWS-22-DCA2C	Windows Server 2022 Data Center - Additional 2 Cores
MSWS-22-DCA2C-NS	Windows Server 2022 DC - Additional 2 Cores - No Cisco SVC
MSWS-22-ST16C	Windows Server 2022 Standard (16 Cores/2 VMs)
MSWS-22-ST16C-NS	Windows Server 2022 Standard (16 Cores/2 VMs) - No Cisco SVC
MSWS-22-STA2C	Windows Server 2022 Standard - Additional 2 Cores
MSWS-22-STA2C-NS	Windows Server 2022 Stan - Additional 2 Cores - No Cisco SVC
Red Hat	
RHEL-2S2V-1A	Red Hat Enterprise Linux (1-2 CPU,1-2 VN); 1-Yr Support Req
RHEL-2S2V-3A	Red Hat Enterprise Linux (1-2 CPU,1-2 VN); 3-Yr Support Req
RHEL-2S2V-5A	Red Hat Enterprise Linux (1-2 CPU,1-2 VN); 5-Yr Support Req
RHEL-VDC-2SUV-1A	RHEL for Virt Datacenters (1-2 CPU, Unlim VN) 1 Yr Supp Req
RHEL-VDC-2SUV-3A	RHEL for Virt Datacenters (1-2 CPU, Unlim VN) 3 Yr Supp Req
RHEL-VDC-2SUV-5A	RHEL for Virt Datacenters (1-2 CPU, Unlim VN) 5 Yr Supp Req
Red Hat Ent Linux/ High Avail/ Res Strg/ Scal	
RHEL-2S2V-1S	Red Hat Enterprise Linux (1-2 CPU,1-2 VN); Prem 1-Yr SnS
RHEL-2S2V-3S	Red Hat Enterprise Linux (1-2 CPU,1-2 VN); Prem 3-Yr SnS
RHEL-2S-HA-1S	RHEL High Availability (1-2 CPU); Premium 1-yr SnS
RHEL-2S-HA-3S	RHEL High Availability (1-2 CPU); Premium 3-yr SnS
RHEL-2S-RS-1S	RHEL Resilient Storage (1-2 CPU); Premium 1-yr SnS
RHEL-2S-RS-3S	RHEL Resilient Storage (1-2 CPU); Premium 3-yr SnS
RHEL-VDC-2SUV-1S	RHEL for Virt Datacenters (1-2 CPU, Unlim VN) 1 Yr SnS Reqd
RHEL-VDC-2SUV-3S	RHEL for Virt Datacenters (1-2 CPU, Unlim VN) 3 Yr SnS Reqd
Red Hat SAP	
RHEL-SAP-2S2V-1S	RHEL for SAP Apps (1-2 CPU, 1-2 VN); Prem 1-Yr SnS
RHEL-SAP-2S2V-3S	RHEL for SAP Apps (1-2 CPU, 1-2 VN); Prem 3-Yr SnS
VMware	
VMW-VSP-STD-1A	VMware vSphere 6 Standard (1 CPU), 1-yr, Support Required
VMW-VSP-STD-3A	VMware vSphere 6 Standard (1 CPU), 3-yr, Support Required

Table 20 Operating System (continued)

Product ID (PID)	PID Description
VMW-VSP-STD-5A	VMware vSphere 6 Standard (1 CPU), 5-yr, Support Required
VMW-VSP-EPL-3A	VMware vSphere 6 Ent Plus (1 CPU), 3-yr, Support Required
VMW-VSP-EPL-1A	VMware vSphere 6 Ent Plus (1 CPU), 1-yr, Support Required
VMW-VSP-EPL-5A	VMware vSphere 6 Ent Plus (1 CPU), 5-yr, Support Required
SUSE	
SLES-2S2V-1A	SUSE Linux Enterprise Svr (1-2 CPU, 1-2 VM); 1-Yr Support Req
SLES-2S2V-3A	SUSE Linux Enterprise Svr (1-2 CPU, 1-2 VM); 3-Yr Support Req
SLES-2S2V-5A	SUSE Linux Enterprise Svr (1-2 CPU, 1-2 VM); 5-Yr Support Req
SLES-2S2V-1S	SUSE Linux Enterprise Svr (1-2 CPU, 1-2 VM); Prio 1-Yr SnS
SLES-2S2V-3S	SUSE Linux Enterprise Svr (1-2 CPU, 1-2 VM); Prio 3-Yr SnS
SLES-2S2V-5S	SUSE Linux Enterprise Svr (1-2 CPU, 1-2 VM); Prio 5-Yr SnS
SLES-2S-HA-1S	SUSE Linux High Availability Ext (1-2 CPU); 1yr SnS
SLES-2S-HA-3S	SUSE Linux High Availability Ext (1-2 CPU); 3yr SnS
SLES-2S-HA-5S	SUSE Linux High Availability Ext (1-2 CPU); 5yr SnS
SLES-2S-GC-1S	SUSE Linux GEO Clustering for HA (1-2 CPU); 1yr Sns
SLES-2S-GC-3S	SUSE Linux GEO Clustering for HA (1-2 CPU); 3yr SnS
SLES-2S-GC-5S	SUSE Linux GEO Clustering for HA (1-2 CPU); 5yr SnS
SLES-2S-LP-1S	SUSE Linux Live Patching Add-on (1-2 CPU); 1yr SnS Required
SLES-2S-LP-3S	SUSE Linux Live Patching Add-on (1-2 CPU); 3yr SnS Required
SLES-2S-LP-1A	SUSE Linux Live Patching Add-on (1-2 CPU); 1yr Support Req
SLES-2S-LP-3A	SUSE Linux Live Patching Add-on (1-2 CPU); 3yr Support Req
SLES and SAP	
SLES-SAP-2S2V-1A	SLES for SAP Apps (1-2 CPU, 1-2 VM); 1-Yr Support Reqd
SLES-SAP-2S2V-3A	SLES for SAP Apps (1-2 CPU, 1-2 VM); 3-Yr Support Reqd
SLES-SAP-2S2V-5A	SLES for SAP Apps (1-2 CPU, 1-2 VM); 5-Yr Support Reqd
SLES-SAP-2S2V-1S	SLES for SAP Apps (1-2 CPU, 1-2 VM); Priority 1-Yr SnS
SLES-SAP-2S2V-3S	SLES for SAP Apps (1-2 CPU, 1-2 VM); Priority 3-Yr SnS
SLES-SAP-2S2V-5S	SLES for SAP Apps (1-2 CPU, 1-2 VM); Priority 5-Yr SnS

STEP 11 CHOOSE OPTIONAL RECOVERY MEDIA

Select the optional recovery media listed in [Table 21](#)

Table 21 OS Media

Product ID (PID)	PID Description
MSWS-19-ST16C-RM	Windows Server 2019 Stan (16 Cores/2 VMs) Rec Media DVD Only
MSWS-19-DC16C-RM	Windows Server 2019 DC (16Cores/Unlim VM) Rec Media DVD Only
MSWS-22-ST16C-RM	Windows Server 2022 Stan (16 Cores/2 VMs) Rec Media DVD Only
MSWS-22-DC16C-RM	Windows Server 2022 DC (16Cores/Unlim VM) Rec Media DVD Only

STEP 12 CHOOSE SERVICE and SUPPORT LEVEL

A variety of service options are available, as described in this section.

Unified Computing Warranty, No Contract

If you have noncritical implementations and choose to have no service contract, the following coverage is supplied:

- Three-year parts coverage.
- Next business day (NBD) parts replacement eight hours a day, five days a week.
- 90-day software warranty on media.
- Ongoing downloads of BIOS, drivers, and firmware updates.
- UCSM updates for systems with Unified Computing System Manager. These updates include minor enhancements and bug fixes that are designed to maintain the compliance of UCSM with published specifications, release notes, and industry standards.

Smart Net Total Care (SNTC) for Cisco UCS

For support of the entire Unified Computing System, Cisco offers the Cisco Smart Net Total Care (SNTC) for UCS Service. This service provides expert software and hardware support to help sustain performance and high availability of the unified computing environment. Access to Cisco Technical Assistance Center (TAC) is provided around the clock, from anywhere in the world.

For systems that include Unified Computing System Manager (UCSM), the support service includes downloads of UCSM upgrades. The Cisco Smart Net Total Care for UCS Service includes flexible hardware replacement options, including replacement in as little as two hours. There is also access to Cisco's extensive online technical resources to help maintain optimal efficiency and uptime of the unified computing environment. For more information please refer to the following URL:

<http://www.cisco.com/c/en/us/services/technical/smart-net-total-care.html?stickynav=1>

You can choose a desired service listed in *Table 22*.

Table 22 Cisco SNTC for UCS Service (PID UCSB-B200-M6)

Service SKU	Service Level GSP	On Site?	Description
CON-PREM-UCSBB2M6	C2P	Yes	SNTC 24X7X2OS
CON-UCSD8-UCSBB2M6	UCSD8	Yes	UC SUPP DR 24X7X2OS*
CON-C2PL-UCSBB2M6	C2PL	Yes	LL 24X7X2OS**
CON-OSP-UCSBB2M6	C4P	Yes	SNTC 24X7X4OS
CON-UCSD7-UCSBB2M6	UCSD7	Yes	UCS DR 24X7X4OS*

Table 22 Cisco SNTC for UCS Service (PID UCSB-B200-M6) (continued)

Service SKU	Service Level GSP	On Site?	Description
CON-C4PL-UCSBB2M6	C4PL	Yes	LL 24X7X4OS**
CON-USD7L-UCSBB2M6	USD7L	Yes	LLUCS HW DR 24X7X4OS***
CON-OSE-UCSBB2M6	C4S	Yes	SNTC 8X5X4OS
CON-UCSD6-UCSBB2M6	UCSD6	Yes	UC SUPP DR 8X5X4OS*
CON-SNCO-UCSBB2M6	SNCO	Yes	SNTC 8x7xNCDOS****
CON-OS-UCSBB2M6	CS	Yes	SNTC 8X5XNBDOS
CON-UCSD5-UCSBB2M6	UCSD5	Yes	UCS DR 8X5XNBDOS*
CON-S2P-UCSBB2M6	S2P	No	SNTC 24X7X2
CON-S2PL-UCSBB2M6	S2PL	No	LL 24X7X2**
CON-SNTP-UCSBB2M6	SNTP	No	SNTC 24X7X4
CON-SNTPL-UCSBB2M6	SNTPL	No	LL 24X7X4**
CON-SNTE-UCSBB2M6	SNTE	No	SNTC 8X5X4
CON-SNC-UCSBB2M6	SNC	No	SNTC 8x7xNCD
CON-SNT-UCSBB2M6	SNT	No	SNTC 8X5XNBD
CON-SW-UCSBB2M6	SW	No	SNTC NO RMA
Note: For PID UCSB-B200-M6-U, select Service SKU with UCSB2M6U suffix (Example: CON-OSP-UCSB2M6U)			
For PID UCSB-B200-M6-CH, select Service SKU with UCSB2M6C suffix (Example: CON-OSP-UCSB2M6C)			
For PID UCSB-B200-M6-BR, select Service SKU with UCSB2M6B suffix (Example: CON-OSP-UCSB2M6B)			
For PID UCSB-B200-M6-U-BR, select Service SKU with UCSB2M6UB suffix (Example: CON-OSP-UCSB2M6UB)			
*Includes Drive Retention (see below for full description)			
**Includes Local Language Support (see below for full description) – Only available in China and Japan			
***Includes Local Language Support and Drive Retention – Only available in China and Japan			

Smart Net Total Care for Cisco UCS Onsite Troubleshooting Service

An enhanced offer over traditional Smart Net Total Care which provides onsite troubleshooting expertise to aid in the diagnostics and isolation of hardware issue within our customers' Cisco Unified Computing System (UCS) environment. It is delivered by a Cisco Certified field engineer (FE) in collaboration with remote TAC engineer and Virtual Internetworking Support Engineer (VISE). You can choose a desired service listed in [Table 23](#).

Table 23 SNTC for Cisco UCS Onsite Troubleshooting Service (PID UCSB-B200-M6)

Service SKU	Service Level GSP	On Site?	Description
CON-OSPT-UCSBB2M6	OSPT	Yes	24X7X40S Trblshtg
CON-OSPTD-UCSBB2M6	OSPTD	Yes	24X7X40S TrblshtgDR*
CON-OSPTL-UCSBB2M6	OSPTL	Yes	24X7X40S TrblshtgLL**
CON-OPTLD-UCSBB2M6	OPTLD	Yes	24X7X40S TrblshtgLLD***
Note: For PID UCSB-B200-M6-U, select Service SKU with UCSB2M6U suffix (Example: CON-OSPT-UCSB2M6U)			
For PID UCSB-B200-M6-CH, select Service SKU with UCSB2M6C suffix (Example: CON-OSPT-UCSB2M6C)			
For PID UCSB-B200-M6-BR, select Service SKU with UCSB2M6B suffix (Example: CON-OSPT-UCSB2M6B)			
For PID UCSB-B200-M6-U-BR, select Service SKU with UCSB2M6UB suffix (Example: CON-OSPT-UCSB2M6UB)			
*Includes Drive Retention (see below for full description)			
**Includes Local Language Support (see below for full description) – Only available in China and Japan			
***Includes Local Language Support and Drive Retention – Only available in China and Japan			

Solution Support for UCS

Solution Support includes both Cisco product support and solution-level support, resolving complex issues in multivendor environments, on average, 43% more quickly than product support alone. Solution Support is a critical element in data center administration, to help rapidly resolve any issue encountered, while maintaining performance, reliability, and return on investment.

This service centralizes support across your multivendor Cisco environment for both our products and solution partner products you've deployed in your ecosystem. Whether there is an issue with a Cisco or solution partner product, just call us. Our experts are the primary point of contact and own the case from first call to resolution. For more information please refer to the following URL:

<http://www.cisco.com/c/en/us/services/technical/solution-support.html?stickynav=1>

You can choose a desired service listed in [Table 24](#).

Table 24 Solution Support for UCS Service (PID UCSB-B200-M6)

Service SKU	Service Level GSP	On Site?	Description
CON-SSC2P-UCSBB2M6	SSC2P	Yes	SOLN SUPP 24X7X2OS
CON-SSC4P-UCSBB2M6	SSC4P	Yes	SOLN SUPP 24X7X4OS
CON-SSC4S-UCSBB2M6	SSC4S	Yes	SOLN SUPP 8X5X4OS
CON-SSCS-UCSBB2M6	SSCS	Yes	SOLN SUPP 8X5XNBDOS
CON-SSDR7-UCSBB2M6	SSDR7	Yes	SSPT DR 24X7X4OS*
CON-SSDR5-UCSBB2M6	SSDR5	Yes	SSPT DR 8X5XNBDOS*
CON-SSS2P-UCSBB2M6	SSS2P	No	SOLN SUPP 24X7X2
CON-SSSNP-UCSBB2M6	SSSNP	No	SOLN SUPP 24X7X4
CON-SSSNE-UCSBB2M6	SSSNE	No	SOLN SUPP 8X5X4
CON-SSSNC-UCSBB2M6	SSSNC	No	SOLN SUPP NCD
CON-SSSNT-UCSBB2M6	SSSNT	No	SOLN SUPP 8X5XNBD
Note: For PID UCSB-B200-M6-U, select Service SKU with UCSB2M6U suffix (Example: CON-SSC4P-UCSB2M6U)			
For PID UCSB-B200-M6-CH, select Service SKU with UCSB2M6C suffix (Example: CON-SSC4P-UCSB2M6C)			
For PID UCSB-B200-M6-BR, select Service SKU with UCSB2M6B suffix (Example: CON-SSC4P-UCSB2M6B)			
For PID UCSB-B200-M6-U-BR, select Service SKU with UCSB2M6UB suffix (Example: CON-SSC4P-UCSB2M6UB)			
*Includes Drive Retention (see below for full description)			

Smart Net Total Care for UCS Hardware Only Service

For faster parts replacement than is provided with the standard Cisco Unified Computing System warranty, Cisco offers the Cisco Smart Net Total Care for UCS Hardware Only Service. You can choose from two levels of advanced onsite parts replacement coverage in as little as four hours. Smart Net Total Care for UCS Hardware Only Service provides remote access any time to Cisco support professionals who can determine if a return materials authorization (RMA) is required. You can choose a desired service listed in [Table 25](#).

Table 25 SNTC for UCS Hardware Only Service (PID UCSB-B200-M6)

Service SKU	Service Level GSP	On Site?	Description
CON-UCW7-UCSBB2M6	UCW7	Yes	UCS HW 24X7X40S
CON-UCWD7-UCSBB2M6	UCWD7	Yes	UCS HW+DR 24X7X40S*
CON-UCW7L-UCSBB2M6	UCW7L	Yes	LL UCS 24X7X40S**
CON-UWD7L-UCSBB2M6	UWD7L	Yes	LL UCS DR 24X7X40S***
CON-UCW5-UCSBB2M6	UCW5	Yes	UCS HW 8X5XNBDOS
CON-UCWD5-UCSBB2M6	UCWD5	Yes	UCS HW+DR 8X5XNBDOS*
Note: For PID UCSB-B200-M6-U, select Service SKU with UCSB2M6U suffix (Example: CON-UCW7-UCSB2M6U)			
For PID UCSB-B200-M6-CH, select Service SKU with UCSB2M6C suffix (Example: CON-UCW7-UCSB2M6C)			
For PID UCSB-B200-M6-BR, select Service SKU with UCSB2M6B suffix (Example: CON-UCW7-UCSB2M6B)			
For PID UCSB-B200-M6-BR, select Service SKU with UCSB2M6UB suffix (Example: CON-UCW7-UCSB2M6UB)			
*Includes Drive Retention (see below for full description)			
**Includes Local Language Support (see below for full description) – Only available in China and Japan			
***Includes Local Language Support and Drive Retention – Only available in China and Japan			

Partner Support Service for UCS

Cisco Partner Support Service (PSS) is a Cisco Collaborative Services service offering that is designed for partners to deliver their own branded support and managed services to enterprise customers. Cisco PSS provides partners with access to Cisco's support infrastructure and assets to help them:

- Expand their service portfolios to support the most complex network environments
- Lower delivery costs
- Deliver services that increase customer loyalty

PSS options enable eligible Cisco partners to develop and consistently deliver high-value technical support that capitalizes on Cisco intellectual assets. This helps partners to realize higher margins and expand their practice. PSS is available to all Cisco PSS partners. The two Partner Unified Computing Support Options include:

- Partner Support Service for UCS
- Partner Support Service for UCS Hardware Only

PSS for UCS provides hardware and software support, including triage support for third party software, backed by Cisco technical resources and level three support. You can choose a desired service listed in [Table 26](#).

Table 26 PSS for UCS (PID UCSB-B200-M6)

Service SKU	Service Level GSP	On Site?	Description
CON-PSJ8-UCSBB2M6	PSJ8	Yes	UCS PSS 24X7X2 OS
CON-PSJ7-UCSBB2M6	PSJ7	Yes	UCS PSS 24X7X4 OS
CON-PSJD7-UCSBB2M6	PSJD7	Yes	UCS PSS 24X7X4 DR*
CON-PSJ6-UCSBB2M6	PSJ6	Yes	UCS PSS 8X5X4 OS
CON-PSJD6-UCSBB2M6	PSJD6	Yes	UCS PSS 8X5X4 DR*
CON-PSJ4-UCSBB2M6	PSJ4	No	UCS SUPP PSS 24X7X2
CON-PSJ3-UCSBB2M6	PSJ3	No	UCS SUPP PSS 24X7X4
CON-PSJ2-UCSBB2M6	PSJ2	No	UCS SUPP PSS 8X5X4
CON-PSJ1-UCSBB2M6	PSJ1	No	UCS SUPP PSS 8X5XNBD
Note: For PID UCSB-B200-M6-U, select Service SKU with UCSB2M6U suffix (Example: CON-PSJ7-UCSB2M6U)			
For PID UCSB-B200-M6-CH, select Service SKU with UCSB2M6C suffix (Example: CON-PSJ7-UCSB2M6C)			
For PID UCSB-B200-M6-BR, select Service SKU with UCSB2M6B suffix (Example: CON-PSJ7-UCSB2M6B)			
For PID UCSB-B200-M6-U-BR, select Service SKU with UCSB2M6UB suffix (Example:			
*Includes Drive Retention (see below for full description)			

PSS for UCS Hardware Only

PSS for UCS Hardware Only provides customers with replacement parts in as little as two hours and provides remote access any time to Partner Support professionals who can determine if a return materials authorization (RMA) is required. You can choose a desired service listed in [Table 27](#).

Table 27 PSS for UCS Hardware Only (PID UCSB-B200-M6)

Service SKU	Service Level GSP	On Site?	Description
CON-PSW7-UCSBB2M6	PSW7	Yes	UCS W PSS 24X7X4 OS
CON-PSWD7-UCSBB2M6	PSWD7	Yes	UCS W PSS 24X7X4 DR*
CON-PSW6-UCSBB2M6	PSW6	Yes	UCS W PSS 8X5X4 OS
CON-PSWD6-UCSBB2M6	PSWD6	Yes	UCS W PSS 8X5X4 DR*
CON-PSW4-UCSBB2M6	PSW4	No	UCS W PL PSS 24X7X2
CON-PSW3-UCSBB2M6	PSW3	No	UCS W PL PSS 24X7X4
CON-PSW2-UCSBB2M6	PSW2	No	UCS W PL PSS 8X5X4
Note: For PID UCSB-B200-M6-U, select Service SKU with UCSB2M6U suffix (Example: CON-PSW7-UCSB2M6U)			
For PID UCSB-B200-M6-CH, select Service SKU with UCSB2M6C suffix (Example: CON-PSW7-UCSB2M6C)			
For PID UCSB-B200-M6-BR, select Service SKU with UCSB2M6B suffix (Example: CON-PSW7-UCSB2M6B)			
For PID UCSB-B200-M6-U-BR, select Service SKU with UCSB2M6UB suffix (Example: CON-PSW7-UCSB2M6UB)			
*Includes Drive Retention (see below for full description)			

Unified Computing Combined Support Service

Combined Services makes it easier to purchase and manage required services under one contract. SNTC services for UCS help increase the availability of your vital data center infrastructure and realize the most value from your unified computing investment. The more benefits you realize from the Cisco Unified Computing System (Cisco UCS), the more important the technology becomes to your business. These services allow you to:

- Optimize the uptime, performance, and efficiency of your UCS
- Protect your vital business applications by rapidly identifying and addressing issues
- Strengthen in-house expertise through knowledge transfer and mentoring
- Improve operational efficiency by allowing UCS experts to augment your internal staff resources
- Enhance business agility by diagnosing potential issues before they affect your operations

You can choose a desired service listed in [Table 28](#)

Table 28 Combined Support Service for UCS (PID UCSB-B200-M6)

Service SKU	Service Level GSP	On Site?	Description
CON-NCF2P-UCSBB2M6	NCF2P	Yes	CMB SVC 24X7X2OS
CON-NCF4P-UCSBB2M6	NCF4P	Yes	CMB SVC 24X7X4OS
CON-NCF4S-UCSBB2M6	NCF4S	Yes	CMB SVC 8X5X4OS
CON-NCFC5-UCSBB2M6	NCFC5	Yes	CMB SVC 8X5XNBDOS
CON-NCF2-UCSBB2M6	NCF2	No	CMB SVC 24X7X2
CON-NCFP-UCSBB2M6	NCFP	No	CMB SVC 24X7X4
CON-NCFE-UCSBB2M6	NCFE	No	CMB SVC 8X5X4
CON-NCFT-UCSBB2M6	NCFT	No	CMB SVC 8X5XNBD
CON-NCFW-UCSBB2M6	NCFW	No	CMB SVC SW
Note: For PID UCSB-B200-M6-U, select Service SKU with UCSB2M6U suffix (Example: CON-NCF4P-UCSB2M6U)			
For PID UCSB-B200-M6-CH, select Service SKU with UCSB2M6C suffix (Example: CON-NCF4P-UCSB2M6C)			
For PID UCSB-B200-M6-BR, select Service SKU with UCSB2M6B suffix (Example: CON-NCF4P-UCSB2M6B)			
For PID UCSB-B200-M6-U-BR, select Service SKU with UCSB2M6UB suffix (Example: CON-NCF4P-UCSB2M6UB)			

UCS Drive Retention Service

With the Cisco Unified Computing Drive Retention Service, you can obtain a new disk drive in exchange for a faulty drive without returning the faulty drive.

Sophisticated data recovery techniques have made classified, proprietary, and confidential information vulnerable, even on malfunctioning disk drives. The Drive Retention service enables you to retain your drives and ensures that the sensitive data on those drives is not compromised, which reduces the risk of any potential liabilities. This service also enables you to comply with regulatory, local, and federal requirements.

If your company has a need to control confidential, classified, sensitive, or proprietary data, you might want to consider one of the Drive Retention Services listed in the above tables (where available).



NOTE: Cisco does not offer a certified drive destruction service as part of this service.

Local Language Technical Support for UCS

Where available, and subject to an additional fee, local language support for calls on all assigned severity levels may be available for specific product(s) - see tables above.

For a complete listing of available services for Cisco Unified Computing System, see the following URL:

http://www.cisco.com/en/US/products/ps10312/serv_group_home.html

SUPPLEMENTAL MATERIAL

System Board

A top view of the UCS B200 M6 system board is shown in [Figure 4](#).

Figure 4 UCS B200 M6 System Board

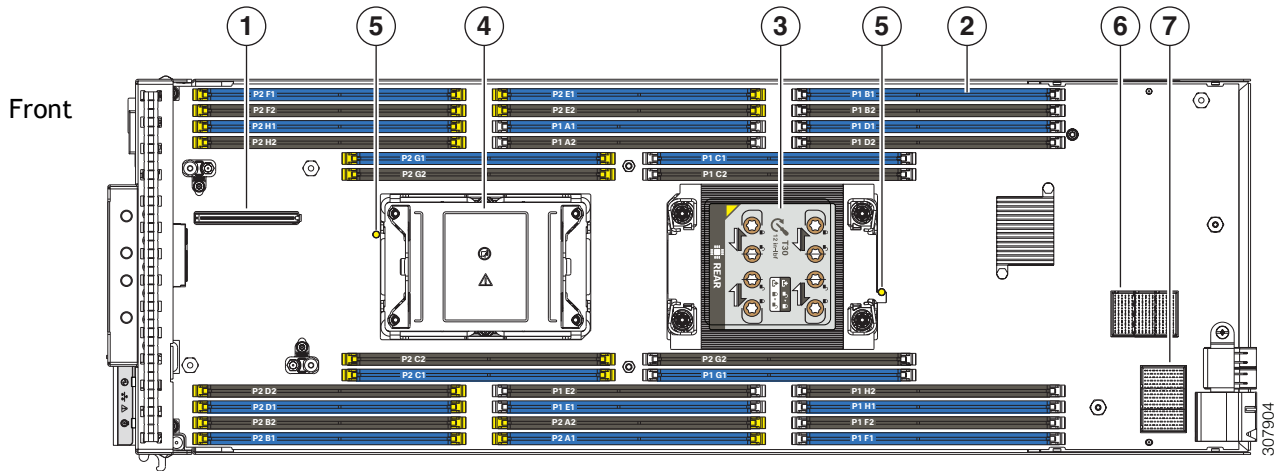

1	Front mezzanine connector	5	CPU heatsink install guide pins
2	DIMM slots DIMMs are secured by white or yellow latches White latches indicate the memory is connected to CPU 1 Yellow latches indicate the memory is connected to CPU 2	6	mLOM connector
3	CPU socket 1 (populated) CPU 1 connects to DIMMs with a white DIMM latch This CPU socket must always be populated	7	Rear mezzanine connector
4	CPU socket 2 (unpopulated) CPU 2 connects to DIMMs with a yellow DIMM latch This CPU socket is populated in a normal, dual-CPU deployment. If your server will run with only one CPU, the CPU must be installed in CPU socket 1.	-	-



CAUTION: The DIMMs installed in sockets with yellow latches are oriented 180 degrees with respect to the DIMMs in the sockets with white latches. Make sure to align the notch keys in DIMMs with the keys in the sockets before inserting to avoid damage to DIMM.

Memory Configuration and Mirroring

When the Memory Mirroring PID (N01-MMIRROR) is selected in [Table 6 Available DDR4 DIMMs and PMem, page 14](#), the DIMMs will be placed as shown in [Table 30 on page 48](#) by the factory

Each CPU has eight DIMM channels:

- CPU1 (P1) has channels A, B, C, D, E, F, G, and H
- CPU2 (P2) has channels A, B, C, D, E, F, G, and H

Each DIMM channel has two slots: slot 1 and slot 2. The blue-colored DIMM slots are for slot 1 and the black slots for slot 2.

As an example, DIMM slots A1, B1, C1, D1, E1, F1, G1, and H1 belong to slot 1, while A2, B2, C2, D2, E2, F2, G2, and H2 belong to slot 2.

[Figure 4 on page 45](#) shows how slots and channels are physically laid out on the motherboard. The DIMM slots for channels A, B, C, D, E, F, G, and H are associated with CPU 1 (P1), while the DIMM slots for channels A, B, C, D, E, F, G, and H are associated with CPU 2 (P2). The slot 1 (blue) DIMM slots are always located farther away from a CPU than the corresponding slot 2 (black) slots.

For all allowable DIMM populations, please refer to the “Memory Population Guidelines” section of the B200 M6 Service and Installation Guide.

https://www.cisco.com/c/en/us/td/docs/unified_computing/ucs/hw/blade-servers/B200M6.pdf

For more details, see the Cisco UCS C220/C240/B200 M6 memory Guide.

<https://www.cisco.com/c/dam/en/us/products/collateral/servers-unified-computing/ucs-c-series-rack-servers/c220-c240-b200-m6-memory-guide.pdf>

When considering the memory configuration of your server, consider the following items:

- Each channel has two DIMM slots (for example, channel A = slots A1 and A2).
 - A channel can operate with one or two DIMMs installed.
- When both CPUs are installed, populate the DIMM slots of each CPU identically.
- Any DIMM installed in a DIMM socket for which the CPU is absent is not recognized.
- Observe the DIMM mixing rules shown in [Table 29 on page 47](#).

Table 29 DIMM Rules for B200 M6 Servers

DIMM Parameter	DIMMs in the Same Channel	DIMM in the Same Slot ¹
DIMM Capacity RDIMM = 16, 32, or 64 GB LRDIMM = 128 GB	DIMMs in the same channel (for example, A1 and A2) can have different capacities. Do not mix RDIMMS with LRDIMMs	For best performance, DIMMs in the same slot (for example, A1, B1, C1, D1, E1, F1, G1, H1) should have the same capacity. Do not mix RDIMMS with LRDIMMs
DIMM Speed 3200 MHz	DIMMs will run at the lowest speed of the CPU installed	DIMMs will run at the lowest speed of the CPU installed
DIMM Type RDIMMs or LRDIMMs	Do not mix DIMM types in a channel	Do not mix DIMM types in a slot

Notes:

1. Although different DIMM capacities can exist in the same slot, this will result in less than optimal performance. For optimal performance, all DIMMs in the same slot should be identical.

- The DIMM/PMem guidelines are as follows:

- All DDR4 DIMMs populated in the DIMM slots must be the same size.
- PMem populated in the memory slots must all be the same size. PMem size mixing is not allowed (for example, you cannot mix 512 GB and 128 GB PMem within the same server).
- Both PMem operational modes (App Direct and Memory Mode) are compatible with the B200 M6.
- Using non-Cisco supported hardware configurations may result in slower performance or a non-supported warning during bootup.

Memory Mirroring

When Memory Mirroring PID (N01-MMIRROR) is selected in *STEP 3 CHOOSE MEMORY, page 13*, the DIMMS will be placed by the factory as shown in the *Table 30*.

- Select 4, 6, 8, or 12 identical DIMMS per CPU.
- If only 1 CPU is selected, please refer only to the CPU 1 DIMM placement columns in the *Table 30*.

Table 30 Memory Mirroring

DIMM Rank	CPU 1 DIMM Placement in Channels (for identical ranked DIMMS)	CPU 2 DIMM Placement in Channels (for identical ranked DIMMS)
4	(A1, B1); (D1, E1)	(A1, B1); (D1, E1)
6	(A1, B1); (C1, D1); (E1, F1)	(A1, B1); (C1, D1); (E1, F1)
8	(A1, B1); (D1, E1); (A2, B2); (D2, E2)	(A1, B1); (D1, E1); (A2, B2); (D2, E2)
12	(A1, B1); (C1, D1); (E1, F1); (A2, B2); (C2, D2); (E2, F2)	(A1, B1); (C1, D1); (E1, F1); (A2, B2); (C2, D2); (E2, F2)
16	(A1, B1); (C1, D1); (E1, F1); (G1, H1); (A2, B2); (C2, D2); (E2, F2), (G2, H2)	(A1, B1); (C1, D1); (E1, F1); (G1, H1); (A2, B2); (C2, D2); (E2, F2), (G2, H2)

Memory Support for 3rd Generation Intel® Xeon® Scalable Processors (Ice Lake)

PMem Support

The Ice Lake CPUs support two memory modes:

- App Direct Mode
- Memory Mode

App Direct Mode

PMem operates as a solid-state disk storage device. Data is saved and is non-volatile. Both DCPMM and DIMM capacities count towards the CPU capacity limit),

For example, if App Direct mode is configured and the DIMM sockets for a CPU are populated with 8 x 128 GB DRAMs (1 TB total DRAM) and 8 x 512 GB PMem (4 TB total PMem), then 5 TB total counts towards the CPU capacity limit. Follow the Intel recommended DRAM:PMem ratio for App Direct Mode.

Memory Mode

PMem operates as a 100% memory module. Data is volatile and DRAM acts as a cache for PMem. Only the PMem capacity counts towards the CPU capacity limit). This is the factory default mode.

For example, if Memory mode is configured and the DIMM sockets for a CPU are populated with 8 x 128 GB DRAMs (1 TB total DRAM) and 8 x 512 GB PMem (4 TB total PMem), then only 4 TB total (the PMem memory) counts towards the CPU capacity limit. All of the DRAM capacity (1 TB) is used as cache and does not factor into CPU capacity. The recommended Intel DRAM:PMem ratio for Memory Mode is 1:4, 1:8, or 1:16.

For 3rd Generation Intel® Xeon® Scalable Processors (Ice Lake):

- DRAMs and PMem are supported
- Each CPU has 16 DIMM sockets and supports the following maximum memory capacities:
 - 2 TB using 16 x 128 GB DRAMs, or
 - 5 TB using 8 x 128 GB DRAMs and 8 x 512 GB TM Modules (PMem)

Only the following mixed DRAM/PMem memory configurations are supported per CPU socket:

- 4 DRAMs and 4 PMem, or 8 DRAMs and 4 PMem, or 8 DRAMs and 1 PMem, or 8 DRAMs and 8 PMem

The available DRAM capacities are 16 GB, 32 GB, 64 GB, or 128 GB

The available PMem capacities are 128 GB, 256 GB, or 512 GB

For further details see the C220/C240/B200 M6 Memory Guide.

<https://www.cisco.com/c/dam/en/us/products/collateral/servers-unified-computing/ucs-c-series-rack-servers/memory-guide-c220-c240-b200-m6.pdf>

SPARE PARTS

This section lists the upgrade and service-related parts for the UCS B200 M6 server. Some of these parts are configured with every server or with every UCS 5108 blade server chassis.

Table 31 Spare Parts

Product ID (PID)	PID Description
Local KVM I/O Cable	
N20-BKVM=	KVM local IO cable for UCS servers console port
CPUs	
 <p>Note: If you are ordering a second CPU, see the CPU Accessories section in this table for additional parts you may need to order for the second CPU.</p>	
8000 Series Processors	
UCS-CPU-I8380=	
UCS-CPU-I8368=	
UCS-CPU-I8362=	
UCS-CPU-I8360Y=	
UCS-CPU-I8358P=	
UCS-CPU-I8358=	
UCS-CPU-I8352M=	
UCS-CPU-I8352Y=	
UCS-CPU-I8352V=	
UCS-CPU-I8352S=	
UCS-CPU-I8351N ¹ =	
6000 Series Processors	
UCS-CPU-I6354=	
UCS-CPU-I6348=	
UCS-CPU-I6346=	
UCS-CPU-I6342=	
UCS-CPU-I6338N=	
UCS-CPU-I6338T=	
UCS-CPU-I6338=	

Table 31 Spare Parts (continued)

Product ID (PID)	PID Description
UCS-CPU-I6336Y=	
UCS-CPU-I6334=	
UCS-CPU-I6330N=	
UCS-CPU-I6330=	
UCS-CPU-I6326=	
UCS-CPU-I6314U ²	
UCS-CPU-I6312U ³ =	
5000 Series Processors	
UCS-CPU-I5320T=	
UCS-CPU-I5320=	
UCS-CPU-I5318N=	
UCS-CPU-I5318S=	
UCS-CPU-I5318Y=	
UCS-CPU-I5317=	
UCS-CPU-I5315Y=	
4000 Series Processors	
UCS-CPU-I4316=	
UCS-CPU-I4314=	
UCS-CPU-I4310T=	
UCS-CPU-I4310=	
UCS-CPU-I4309Y=	
CPU Accessories	
UCSB-HS-M6-F	CPU Heat Sink for UCS B-Series M6 CPU socket (Front)
UCSB-HS-M6-R	CPU Heat Sink for UCS B-Series M6 CPU socket (Rear)
UCS-CPU-TIM=	Single CPU thermal interface material syringe for M6 server HS seal
UCSX-HSCK=	UCS Processor Heat Sink Cleaning Kit (when replacing a CPU)
UCS-CPUAT=	CPU Assembly Tool for M6 Servers
UCS-M6-CPU-CAR=	UCS M6 CPU Carrier
UCS-CPUATI-4=	CPX-4 CPU Assembly tool for M6 Servers

Table 31 Spare Parts (continued)

Product ID (PID)	PID Description
UCS-CPUATI-3=	ICX CPU Assembly Tool for M6 Servers
Memory	
UCS-MR-X16G1RW=	16 GB RDIMM SRx4 3200 (8Gb)
UCS-MR-X32G2RW=	32 GB RDIMM DRx4 3200 (8Gb)
UCS-MR-X32G1RW =	32GB RDIMM SRx4 3200 (16Gb)
UCS-MR-X64G2RW=	64 GB RDIMM DRx4 3200 (16Gb)
UCS-ML-128G4RW=	128 GB LRDIMM QRx4 3200 (16Gb)
UCS-MP-128GS-B0=	Intel® Optane™ Persistent Memory, 128GB, 3200-MHz
UCS-MP-256GS-B0=	Intel® Optane™ Persistent Memory, 256GB, 3200-MHz
UCS-MP-512GS-B0=	Intel® Optane™ Persistent Memory, 512GB, 3200-MHz
DIMM Blank	
UCS-DIMM-BLK=	Cisco UCS DIMM Blank
Rear Mezzanine Adapters	
UCSB-MLOM-40G-04=	Cisco UCS VIC 1440 modular LOM for blade servers
UCSB-MLOM-PT-01=	Cisco UCS Port Expander Card for VIC
UCSB-VIC-M84-4P=	Cisco UCS VIC 1480 mezzanine adapter
Front Mezzanine Adapters	
UCSB-RAID12G-M6=	Cisco FlexStorage 12G RAID controller with drive bays for two SAS/SATA solid state drives (SSDs)
UCSB-LSTOR-PT-M6=	Cisco FlexStorage pass-through module with drive bays for two PCIe NVMe drives
UCSB-MSTOR-M6=	Mini storage carrier that holds up to two SATA M.2 RAID cards
SATA SSD Drives	
UCS-SD480GBI6-EP=	480GB 2.5in Enterprise performance 6GSATA SSD(3X endurance)
UCS-SD960GBI6-EP=	960GB 2.5in Enterprise performance 6GSATA SSD(3X endurance)
UCS-SD19TBI6-EP=	1.9TB 2.5in Enterprise performance 6GSATA SSD(3X endurance)
UCS-SD480GBM6-EP=	480GB 2.5in Enterprise performance 6GSATA SSD(3X endurance)
UCS-SD960GBM6-EP=	960GB 2.5in Enterprise performance 6GSATA SSD(3X endurance)
UCS-SD19TM6-EP=	1.9TB 2.5in Enterprise performance 6GSATA SSD(3X endurance)
UCS-SD19TBM6-EP=	1.9TB Enterprise value SATA SSD (1X , SED)

Table 31 Spare Parts (continued)

Product ID (PID)	PID Description
UCS-SD960GM6-EP=	960GB 2.5in Enterprise performance 6GSATA SSD(3X endurance)
UCS-SD480GM6-EP=	480GB 2.5in Enterprise performance 6GSATA SSD(3X endurance)
UCS-SD120GM6-EV=	Micron 5300
UCS-SD240GM6-EV=	Micron 5300
UCS-SD480GI6-EV=	Intel S4510
UCS-SD960GI6-EV=	Intel S4510
UCS-SD16TM6-EV=	Micron 5300
UCS-SD19TM6-EV=	Micron 5300
UCS-SD38TM6-EV=	Micron 5300
UCS-SD38TI6-EV=	Intel S4510
UCS-SD76TM6-EV=	Micron 5300
UCS-SD960GS6-EV=	Samsung PM883
UCS-SD19TS6-EV=	Samsung PM883
UCS-SD38TS6-EV=	Samsung PM883
UCS-SD480GM6-EV=	480 GB 2.5 inch Enterprise Value 6G SATA SSD
UCS-SD960GM6-EV=	960 GB 2.5 inch Enterprise Value 6G SATA SSD
UCS-SD960GS26-EV=	960GB 2.5 inch Enterprise Value 6G SATA SSD
UCS-SD19TS26-EV=	1.9TB 2.5 inch Enterprise Value 6G SATA SSD
UCS-SD38TS26-EV=	3.8TB 2.5 inch Enterprise Value 6G SATA SSD
UCS-SD78TS26-EV=	7.6TB 2.5 inch Enterprise Value 6G SATA SSD
NVME SSD Drives	
UCSB-NVMEM6-W800=	800 GB 2.5in U.2 WD SN640 NVMe Med Perf. High Endurance
UCSB-NVMEM6-W1920=	1.9 TB 2.5in U.2 WD SN640 NVMe Med Perf. Value Endurance
UCSB-NVMEM6-W3800=	3.8 TB 2.5in U.2 WD SN640 NVMe Med Perf. Value Endurance
UCSB-NVMEM6-W6400=	6.4 TB 2.5in U.2 WD SN640 NVMe Med Perf. High Endurance
UCSB-NVMEM6-M7600=	7.6TB 2.5in U.3 7mm Micron 7450 Hg Perf Med End NVMe (1X)
SED Drives	
UCS-SD38TBM6NK9=	3.8TB Enterprise Value SATA SSD (1X, SED)
UCS-SD76TBM6NK9=	7.6TB Enterprise Value SATA SSD (1X, SED)

Table 31 Spare Parts (continued)

Product ID (PID)	PID Description
SATA M.2 Storage Modules	
UCS-M2-240GB=	Micron 5100 240G SATA M.2
UCS-M2-960GB=	Micron 5100 960G SATA M.2
Note: If you order M.2 SATA drives, you must select the boot-optimized RAID controller.	
Boot-Optimized RAID Controller	
UCS-M2-HWRAID	Cisco Boot optimized M.2 RAID controller
Drive Blank	
UCSB-FBLK-M6=	Cisco B200 M6 7mm Front Drive Blank
TPM	
UCSX-TPM-002C=	Trusted Platform Module for Whitley Provisioning
UCSX-TPM-OPT-OUT=	OPT OUT, TPM 2.0, TCG, FIPS140-2, CC EAL4+ Certified
Software/Firmware	
Windows Server Recovery Media	
MSWS-19-ST16C-RM=	Windows Server 2019 Stan (16 Cores/2 VMs) Rec Media DVD Only
MSWS-19-DC16C-RM=	Windows Server 2019 DC (16Cores/Unlim VM) Rec Media DVD Only
MSWS-22-ST16C-RM=	Windows Server 2022 Stan (16 Cores/2 VMs) Rec Media DVD Only
MSWS-22-DC16C-RM=	Windows Server 2022 DC (16Cores/Unlim VM) Rec Media DVD Only
RHEL SAP	
RHEL-SAPSP-3S=	RHEL SAP Solutions Premium - 3 Years
RHEL-SAPSS-3S=	RHEL SAP Solutions Standard - 3 Years
RHEL-SAPSP-R-1S=	Renew RHEL SAP Solutions Premium - 1 Year
RHEL-SAPSS-R-1S=	Renew RHEL SAP Solutions Standard - 1 Year
RHEL-SAPSP-R-3S=	Renew RHEL SAP Solutions Premium - 3 Years
RHEL-SAPSS-R-3S=	Renew RHEL SAP Solutions Standard -3 Years
VMware vSphere	
VMW-VSP-STD-1A=	VMware vSphere 7 Std (1 CPU, 32 Core) 1-yr, Support Required
VMW-VSP-STD-3A=	VMware vSphere 7 Std (1 CPU, 32 Core) 3-yr, Support Required
VMW-VSP-STD-5A=	VMware vSphere 7 Std (1 CPU, 32 Core) 5-yr, Support Required
VMW-VSP-EPL-1A=	VMware vSphere 7 Ent Plus (1 CPU, 32 Core) 1Yr, Support Reqd

Table 31 Spare Parts (continued)

Product ID (PID)	PID Description
VMW-VSP-EPL-3A=	VMware vSphere 7 Ent Plus (1 CPU, 32 Core) 3Yr, Support Reqd
VMW-VSP-EPL-5A=	VMware vSphere 7 Ent Plus (1 CPU, 32 Core) 5Yr, Support Reqd
VMW-VSP-STD-1S=	VMware vSphere 7 Std (1 CPU, 32 Core), 1-yr Vmware SnS Reqd
VMW-VSP-STD-3S=	VMware vSphere 7 Std (1 CPU, 32 Core), 3-yr Vmware SnS Reqd
VMW-VSP-STD-1YR	VMware vSphere 7 Std SnS - 1 Year (reports to PID VMW-VSP-STD-1S=)
VMW-VSP-STD-3YR	VMware vSphere 7 Std SnS - 3 Year (reports to PID VMW-VSP-STD-3S=)
VMW-VSP-EPL-1S=	VMware vSphere 7 EntPlus (1 CPU 32 Core) 1Yr VMware SnS Reqd
VMW-VSP-EPL-3S=	VMware vSphere 7 EntPlus (1 CPU 32 Core) 3Yr VMware SnS Reqd
VMW-VSP-EPL-1YR	VMware vSphere 7 Enterprise Plus SnS - 1 Year (reports to PID VMW-VSP-EPL-1S=)
VMW-VSP-EPL-3YR	VMware vSphere 7 Enterprise Plus SnS - 3 Year (reports to PID VMW-VSP-EPL-3S=)
VMware vCenter	
VMW-VCS-STD-1A=	VMware vCenter 7 Server Standard, 1 yr support required
VMW-VCS-STD-3A=	VMware vCenter 7 Server Standard, 3 yr support required
VMW-VCS-STD-5A=	VMware vCenter 7 Server Standard, 5 yr support required
VMW-VCS-STD-1S=	VMware vCenter 7 Server Standard, 1-yr Vmware SnS Reqd
VMW-VCS-STD-3S=	VMware vCenter 7 Server Standard, 3-yr Vmware SnS Reqd
VMW-VCS-STD-1YR	VMware vCenter 6 Server Standard SnS - 1 Year (reports to PID VMW-VCS-STD-1S=)
VMW-VCS-STD-3YR	VMware vCenter 6 Server Standard SnS - 3 Year (reports to PID VMW-VCS-STD-3S=)
VMW-VCS-FND-1A=	VMware vCenter Server 7 Foundation (4 Host), 1 yr supp reqd
VMW-VCS-FND-3A=	VMware vCenter Server 7 Foundation (4 Host), 3 yr supp reqd
VMW-VCS-FND-5A=	VMware vCenter Server 7 Foundation (4 Host), 5 yr supp reqd
VMW-VCS-FND-1S=	VMware vCenter Server 7 Foundation (4 Host), 1yr VM SnS Reqd
VMW-VCS-FND-3S=	VMware vCenter Server 7 Foundation (4 Host), 3yr VM SnS Reqd
VMW-VCS-FND-1YR	VMware vCenter Server 6 Foundation (4 Host) SnS - 1 Year (reports to PID VMW-VCS-FND-1S=)
VMW-VCS-FND-3YR	VMware vCenter Server 6 Foundation (4 Host) SnS - 3 Year (reports to PID VMW-VCS-FND-3S=)

Table 31 Spare Parts (continued)

Product ID (PID)	PID Description
VMware vSphere Upgrades	
VMW-VSS2VSP-1A=	Upgrade: vSphere 7 Std to vSphere 7 Ent Plus (1 yr Supp Req)
VMW-VSS2VSP-3A=	Upgrade: vSphere 7 Std to vSphere 7 Ent Plus (1 yr Supp Req)

Notes:

1. The maximum number of UCS-CPU-I8351N CPUs is one
2. The maximum number of UCS-CPU-I6314U CPUs is one
3. The maximum number of UCS-CPU-I6312U CPUs is one

Please refer to the [UCS B200 M6 Installation Guide](#) for installation procedures.

UPGRADING or REPLACING CPUs



NOTE: Before servicing any CPU, do the following:

- Decommission and power off the server.
- Slide the B200 M6 out from its chassis.
- Remove the top cover.

To replace an existing CPU, follow these steps:

(1) Have the following tools and materials available for the procedure:

- T-30 Torx driver—Supplied with replacement CPU.
- #1 flat-head screwdriver—Supplied with replacement CPU.
- CPU assembly tool—Supplied with replacement CPU. Can be ordered separately as Cisco PID UCS-CPUAT=.
- Heatsink cleaning kit—Supplied with replacement CPU. Can be ordered separately as Cisco PID UCSX-HSCK=.
- Thermal interface material (TIM)—Syringe supplied with replacement CPU. Can be ordered separately as Cisco PID UCS-CPU-TIM=.

(2) Order the appropriate replacement CPU from [Available CPUs on page 9](#).

(3) Carefully remove and replace the CPU and heatsink in accordance with the instructions found in “Cisco UCS B200 M6 Blade Server Installation and Service Note,” found at:

https://www.cisco.com/content/en/us/td/docs/unified_computing/ucs/hw/blade-servers/B200M6.html

To add a new CPU, follow these steps:

(1) Have the following tools and materials available for the procedure:

- T-30 Torx driver—Supplied with new CPU.
- #1 flat-head screwdriver—Supplied with new CPU
- CPU assembly tool—Supplied with new CPU. Can be ordered separately as Cisco PID UCS-CPUAT=
- Thermal interface material (TIM)—Syringe supplied with replacement CPU. Can be ordered separately as Cisco PID UCS-CPU-TIM=

(2) Order the appropriate new CPU from [Table 3 on page 9](#).

(3) Order one heat sink for each new CPU. Order PID UCSB-HS-M6-F= for the front CPU socket and PID UCSB-HS-M6-R= for the rear CPU socket.

(4) Carefully install the CPU and heatsink in accordance with the instructions found in “Cisco UCS B200 M6 Blade Server Installation and Service Note,” found at: https://www.cisco.com/content/en/us/td/docs/unified_computing/ucs/hw/blade-servers/B200M6.html.

UPGRADING or REPLACING MEMORY



NOTE: Before servicing any DIMM or PMem, do the following:

- Decommission and power off the server.
- Remove the top cover from the server
- Slide the server out the front of the chassis.

To add or replace DIMMs or PMem, follow these steps:

Step 1 Open both DIMM connector latches.

Step 2 Press evenly on both ends of the DIMM until it clicks into place in its slot

Note: Ensure that the notch in the DIMM aligns with the slot. If the notch is misaligned, it is possible to damage the DIMM, the slot, or both.

Step 3 Press the DIMM connector latches inward slightly to seat them fully.

Step 4 Populate all slots with a DIMM or DIMM blank. A slot cannot be empty.

Figure 5 Replacing Memory

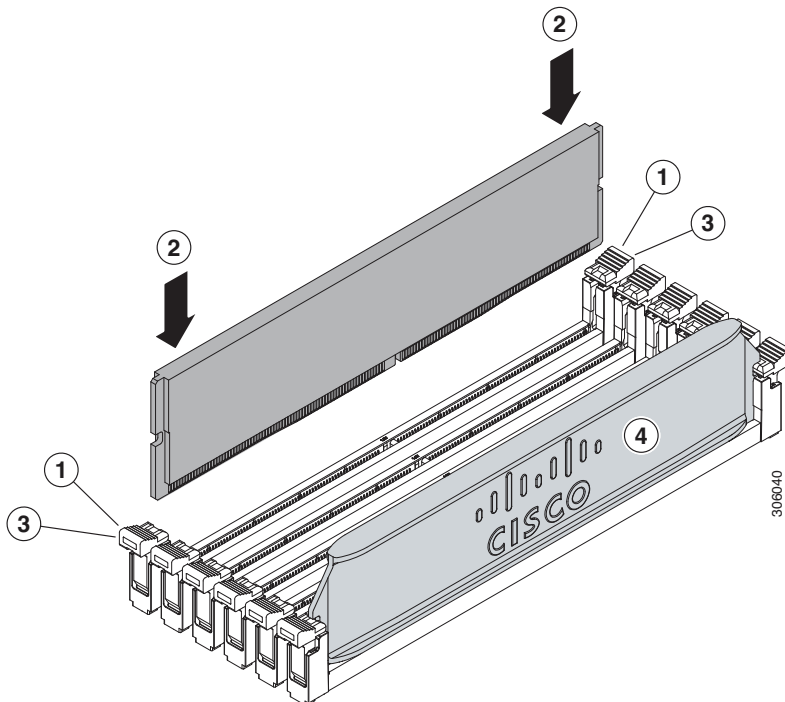



CAUTION: The DIMMs installed in sockets with yellow latches are rotated 180 degrees with respect to the DIMMs/PMem in the sockets with white latches. Make sure to align the notch keys in DIMMs/PMem with the keys in the sockets before inserting to avoid damage to DIMMs/PMem.

For additional details on replacing or upgrading DIMMs, see “Cisco UCS B200 M6 Blade Server Installation and Service Note,” found at https://www.cisco.com/content/en/us/td/docs/unified_computing/ucs/hw/blade-servers/B200M6.html

DISCONTINUED EOL PRODUCTS

Below is the list of parts were previously available for this product and are no longer sold. Please refer to the EOL Bulletin Links via the Table 36 below to determine if still supported.

Table 32 EOS

Product ID	Description	EOL/EOS link
Operating system		
SLES-2SUV-1A	SUSE Linux Enterprise Svr (1-2 CPU,Unl VM); 1-Yr Support Req	
SLES-2SUV-1S	SUSE Linux Enterprise Svr (1-2 CPU,Unl VM); Prio 1-Yr SnS	
SLES-2SUV-3A	SUSE Linux Enterprise Svr (1-2 CPU,Unl VM); 3-Yr Support Req	
SLES-2SUV-3S	SUSE Linux Enterprise Svr (1-2 CPU,Unl VM); Prio 3-Yr SnS	
SLES-2SUV-5A	SUSE Linux Enterprise Svr (1-2 CPU,Unl VM); 5-Yr Support Req	
SLES-2SUV-5S	SUSE Linux Enterprise Svr (1-2 CPU,Unl VM); Prio 5-Yr SnS	
SLES-SAP-2SUV-1A	SLES for SAP Apps w/ HA (1-2 CPU, Unl VM); 1-Yr Support Reqd	
SLES-SAP-2SUV-1S	SLES for SAP Apps (1-2 CPU, Unl VM); Priority 1-Yr SnS	
SLES-SAP-2SUV-3A	SLES for SAP Apps w/ HA (1-2 CPU, Unl VM); 3-Yr Support Reqd	
SLES-SAP-2SUV-3S	SLES for SAP Apps (1-2 CPU, Unl VM); Priority 3-Yr SnS	
SLES-SAP-2SUV-5A	SLES for SAP Apps w/ HA (1-2 CPU, Unl VM); 5-Yr Support Reqd	
SLES-SAP-2SUV-5S	SLES for SAP Apps (1-2 CPU, Unl VM); Priority 5-Yr SnS	

TECHNICAL SPECIFICATIONS

Dimensions and Weight

Table 33 UCS B200 M6 Dimensions and Weight

Parameter	Value
Height	1.95 in. (50 mm)
Width	8.35 in.(212 mm)
Depth	24.4 in. (620 mm)
Weight	<ul style="list-style-type: none"> ■ Base server weight = 10.0 lbs (4.54 kg) (no HDDs, no CPUs, no DIMMs, no mezzanine adapters or memory) ■ Minimally configured server weight = 10.08 lbs (4.57 kg) (no HDDs, 2 CPUs, 2 DIMMs, VIC 1440 but no additional mezzanine adapter) ■ Fully configured server weight = 18.14 lbs (8.23 kg) (2 HDDs, 2 CPUs, 32 DIMMs, VIC 1440 and additional mezzanine adapter both populated)

Power Specifications

For configuration-specific power specifications, use the Cisco UCS Power Calculator at:

<http://ucspowercalc.cisco.com>



NOTE: The B200 M6 has a power cap of 960 Watts for all combinations of components (CPUs, DIMMs, drives, and so on).



Americas Headquarters
Cisco Systems, Inc.
San Jose, CA

Asia Pacific Headquarters
Cisco Systems (USA) Pte. Ltd.
Singapore

Europe Headquarters
Cisco Systems International BV Amsterdam,
The Netherlands

Cisco has more than 200 offices worldwide. Addresses, phone numbers, and fax numbers are listed on the Cisco Website at www.cisco.com/go/offices.

Cisco and the Cisco Logo are trademarks of Cisco Systems, Inc. and/or its affiliates in the U.S. and other countries. A listing of Cisco's trademarks can be found at www.cisco.com/go/trademarks. Third party trademarks mentioned are the property of their respective owners. The use of the word partner does not imply a partnership relationship between Cisco and any other company. (1005R)

