

User Manual

Please read this user manual throughout before using

Ver:A

Preface

All internal technologies of this product are protected, including device, software and trademark. Reproduction in whole or in part without written permission is prohibited.

All brands and trademarks of SWIT Electronics Co., Ltd. are protected and other relative trademarks in this user manual are the property of their respective owners.

Due to constant effort of product development, SWIT reserves the right to make changes and improvements to the product described in this manual without prior notice.

The warranty period of this product is 2 years, and does not cover the following:

- (1) Physical damage to the surface of the products, including scratches, cracks or other damage to the LCD screen or other externally exposed parts;
 - (2) The LCD dot defects are not over three;
 - (3) Any damage caused by using third-party power adaptors;
 - (4) Any damage or breakdown caused by use, maintenance or storage not according to the user manual.
 - (5) The product is disassembled by anyone other than an authorized service center.
 - (6) Any damage or breakdown not caused by the product design, workmanship, or manufacturing quality, etc.
- * Any sales personnel have no rights to provide additional warranty.

For any suggestions and requirements on this product, please contact us through phone, fax, Email, etc.

- ※ This manual is applicable to all models of BM-U (5 generation), and the schematic diagram is taken as the appearance diagram of BM-U245. Any specification, appearance, this manual will be additional text description.

SWIT Electronics Co., Ltd.

Address: 10 Hengtong Road, Nanjing Economic and Technological Development Zone,
Nanjing 210038, P.R.China
Phone: +86-25-85805753
Fax: +86-25-85805296
Email: contact@swit.cc
<http://www.swit.cc>

Warning

1. In order to reduce the risk of fire and electrical shock, do not lay this product in rain or damp places.
2. Please keep away from the strong magnetic field; it may cause the noise of the video and audio signals.

The power

1. Please use the power adapter provided or recommended by the manufacturer in order to avoid damage.
2. For a third party power adapter, please make sure the voltage range, supplied power, and polarity of power lead are fit.
3. Please disconnect the power cable under the following situations:
 - (A). If you do not operate this monitor for a period of time;
 - (B). If the power cable or power adaptor is damaged;
 - (C). If the monitor housing is broken.

The monitor

1. Please don't touch the screen with your fingers, which would probably deface the screen.
2. Please don't press the screen; the LCD is extremely exquisite and flimsy.
3. Please don't lay this product on unstable place.

Cleaning

1. Please clean the screen with dry and downy cloth or special LCD cleanser.
2. Please do not press hard when cleaning the screen.
3. Please do not use water or other chemical cleanser to clean the screen.
The chemical may damage the LCD.

Contents

Preface	2
Maintenance	3
Contents	4
Packing List	4
Introduction	4
Operation Introduction	5
Front panel	5
Rear panel	7
OSD	8
Main Menu	11
Size	25
Specification	26
Trouble-Shooting	29

Packing list

No.	Standard package	Details
1	Monitor	X 1
2	Warrantee card	X 1
3	Battery plate (V-mount or Gold-mount)	X 1
4	Tabletop stand	X 2
5	Power cord	X 1

※ Only BM-U175/BM-U245/BM-U245HDR are equipped with battery gusset plate.

Introduction

This series of monitors adopt TFT-LCD panel, the resolution is up to 3840×2160, H178° / V178° ultra-wide viewing angle, supports 4 x 12G/6G/3G/HD/SD-SDI, 1 x HDMI® 2.0 4K@60 with 4 x 12G/6G/3G/HD/SD-SDI loop outs with headphone and speaker outputs.

Features:

- 3840X2160 Ultra HD, (※ BM-U315/BM-U316 Ultra 4096X2160)
- 4K/UHD interface (4x12G-SDI input, 4x12G-SDI output, 1x HDMI® 2.0 4K@60 input)
- 16ch audio bar display, with any selected 2ch output
- Support waveform selection display Y/Cb/Cr/R/G/B /RGB and single line selection mode
- Vector scope, R/G/B/Y histogram, bi-color focus assist
- 3DLUT (17 x 17 x 17) accurate color correction
- Dynamic UMD and TALLY(TSL3.1, 4.0) display
- Composition ratio auxiliary line:4:3/13:9/14:9/15:9/16:9/1.85:1/2.35:1/2:1/1.39:1/Custom1/ Custom2
- Support USB firmware upgrade and import Log file.(USB file system supports FAT 32 format only)
- Eco mode

• Front panel

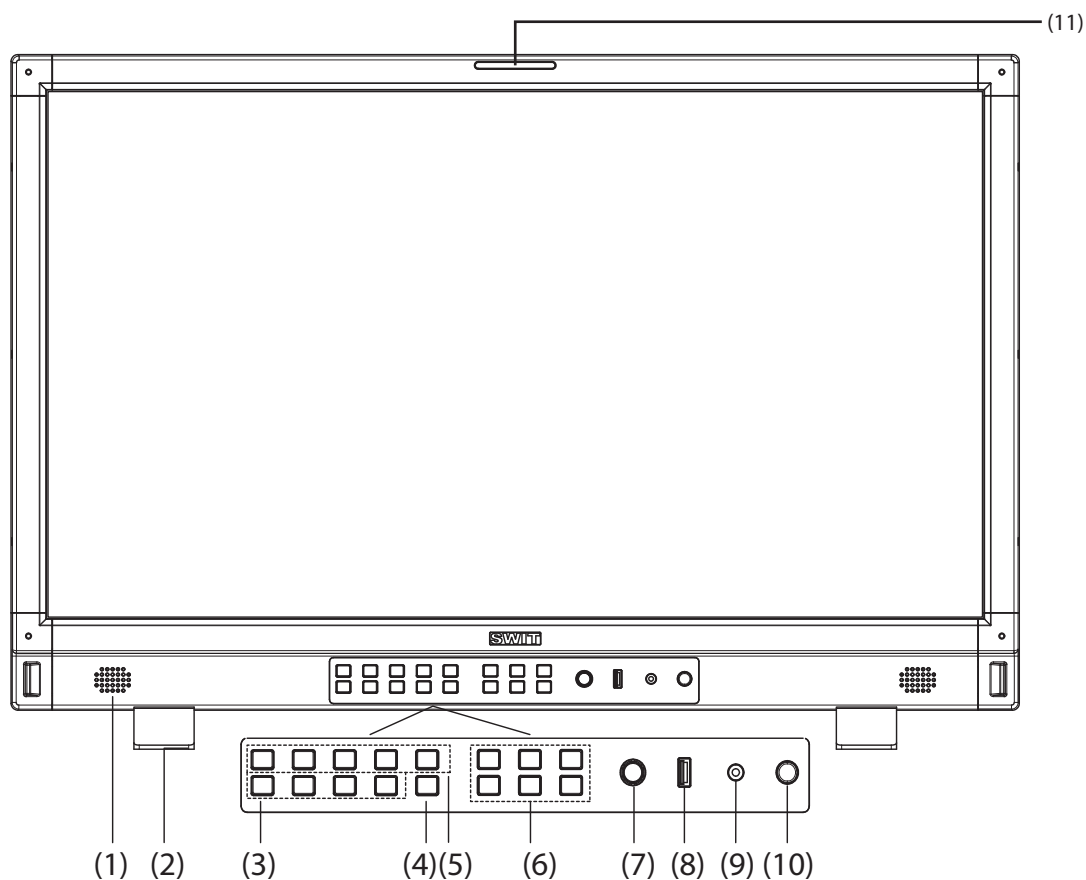

- (1) **Speaker:** For SDI/HDMI® embedded audio. (Will not work if earphone is plugged in)
- (2) **Desktop Stand Feet**
- (3) **User1~User4:** User shortcut key, which can be used to quickly enter the set user mode.
Long press to save user settings. Please see details in “9. System”
- (4) **Info/Quit:** Display setting item. Press " Info/Quit " button to display or turn off relevant status information and audio and video analysis function graph. When opening the menu, press " Info/Quit " to exit the menu with one click
- (5) **F1~F5 function keys:** Customize shortcut function keys. Users can set the shortcut keys to different functions according to their own requirements.

(6)

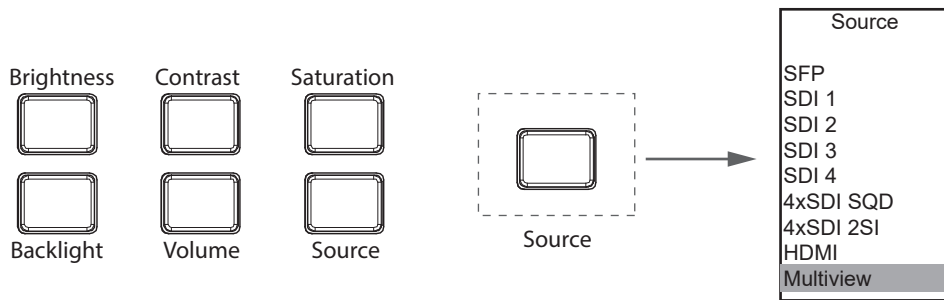

Brightness: Adjust the brightness. -100~100 adjustable, default value is 0.

Contrast: Adjust contrast. -100~100 adjustable, default value is 0.

Saturation: Adjust saturation. -100~100 adjustable, default value is 0.

Backlight: Adjust the backlight. 0~100 adjustable, default value is 16.

(The default backlight value of BM-U245 is 35.)

Press Brightness, Contrast, Saturation, Backlight, Volume five shortcut keys confirm to select this option, and rotate Menu to adjust the corresponding item value directly. Press the button and automatically cancel the selection without operation within five seconds, and the button light will be off, long press to restore default values.

Volume: Adjust the volume. 0~100 adjustable, the default value is 36. Long press the volume button to mute.

Source: Select the input source signal format. As shown in the figure above, when Multi-screen is selected, the screen is divided into 4 frames, and 4 channels of SDI signals can be displayed simultaneously. When Four-screen is opened, some menu functions are turned off or displayed in gray.

(7) **Menu/Enter:** When no Menu is displayed, press the button directly to open the Main Menu; Rotate the knob to select different settings or adjust parameter values, press the knob to set.

(8) **LUT/Firmware:** Update firmware or import LUT files, Auto Calibration.

(9) **PHONE:** 3.5mm headphone jack is used to monitor the embedded audio signals of SDI and HDMI.

(10) **Power:** Power switch.

(11) **Tally lamp:** You can select the color of the tally lamp from “Green”, “Red”, or “Yellow”

• Rear panel

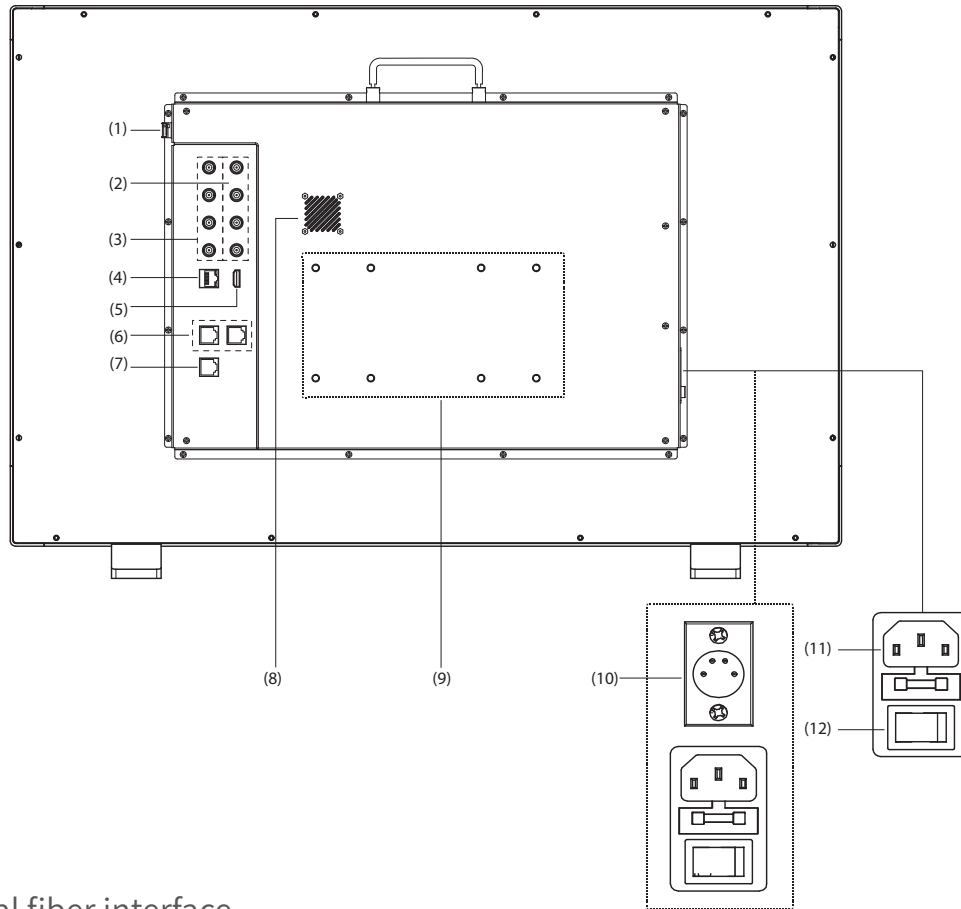

- (1) **SFP IN:** Optical fiber interface
12G/6G/3G/HD/SD-SDI video signal fiber input interface
 - Fiber optic module is optional
- (2) SDI IN1~4: 12G-SDI
- (3) SDI OUT1~4: 12G-SDI
- (4) ETHERNET: Network interface
1000M high-speed RJ45 Ethernet port, for web server IP external control.
- (5) HDMI® 2.0 4K@60 IN :
 - Will not display HDCP protected content.
- (6) RS485: TSL UMD control port
- (7) GPI: GPI control port
- (8) Fan
- (9) VESA bracket mounting area
- (10) DC IN: 12V~17V
- (11) AC IN: 100V~240V
- (12) AC switch: Used to directly turn on or off AC power supply

※ BM-U175/BM-U245/BM-U245HDR supported DC, AC and battery powered three types of power supply. BM-U275HDR/BM-U315/BM-U325/BM-U325HDR/BM-U316HDR AC power supply only.

• OSD

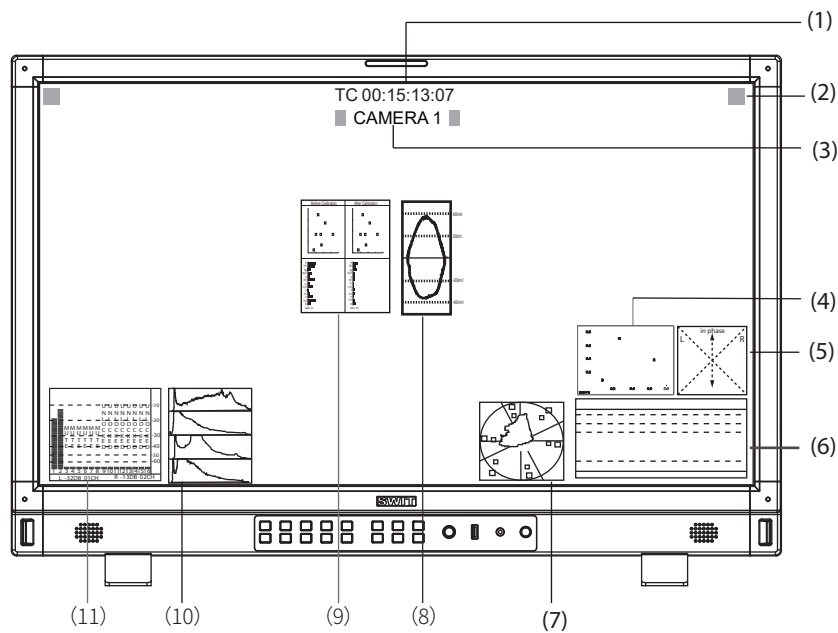

(1) Time code (SDI)

Under SDI input, the monitor can display Time code information (LTC, VITC1&2). If no Time code info is detected, it will display “TC UNLOCKED”. User can set function keys F1~F5 or GPI pins as “Time Code” to turn on or off this function.

(2) On screen TALLY

Display TALLY signal from GPI port.

(3) Source ID/UMD

Display TSL 3.1/4.0 UMD or User input Source ID.

(4) Colour gamut chart

Displays the current video colour gamut, which can be set by the user in the "Main Menu" - "Colour Management" - "Colour Gamut

(5) Lissajous

Lissajous diagram showing audio signal. Users can set the shortcut keys (F1~F5) or GPI pins on the front panel to “Lissajous” function and turn it on/off.

(6) Waveform

The display waveform can be selected from Y/Cb/Cr/R/G/B/RGB types, and single line display mode selectable. The waveform display positions, colors, background are adjustable. User can set function keys F1~F5 or GPI pins as “Waveform” to turn on or off this function.

(7) Vector

Display vector scope with 100% and 75% markers for SDI and HDMI® video. The vector scope pattern display positions, colors, background are adjustable. User can set function keys F1~F5 or GPI pins as “Vector” to turn on or off this function

(8) eye pattern

Tests the quality of the SDI signal, the larger the eye pattern, the stronger the quality.

(9) ColorChecker

After auto calibration, the color gamut and chromatic aberration (ΔE) “Automatic colour correction” - “Start colour proofing” and "Auto Calibration" - "Measure" pops up the gamut value and color difference value (ΔE) of the previous calibration and this measurement.

(10) Histogram

Parallel display R/G/B/Y histogram for SDI and HDMI® video. User can set function keys F1~F5 or GPI pins as “Histogram” to turn on or off this function.

(11) Audio VU/PPM meters

Display meters of SDI/ HDMI®embedded audio or analog audio. The audio meter display channels, on screen positions, markers and background colors are adjustable. User can set function keys F1~F5 or GPI pins as “Audio Bar” to turn on or off this function.

• Status display

Main Menu		Status	
Exit&Status		Format >	XX (1)
Input	>	Source >	XX (2)
Picture	>	Color Temp >	XX (3)
Color Management	>	F1 >	XXX (4)
Scanning	>	F2	XXX
Control	>	F3	XXX
Assist	>	F4	XXX
De-embed	>	F5	XXX
Auto Calibration	>	Profile Type >	XX (5)
System	>	Version >	XX (6)
Multiview Setting	>		

Press “Menu/Enter” button, the main menu will pop up from the left top of the screen. The main menu displays the current working status of the monitor.

(1) Format

A format for displaying the current input signal, if there is no currently identifiable signal input, display "no Signal". When Four-screen is selected for the current channel, the input signal standard of SDI 1/2/3/4 orSDI 1/2/3/HDMI® channel is displayed in standard.

(2) Source

Displays the currently selected channel

(3) Color Temp

Displays the currently set color temperature mode

(4) F1~F5

Displays the function value set by the current function key

(5) Profile Type

Displays the currently set scan mode

(6) Version

Displays the current software version number

Steps

1. Press “Menu/ Enter” button, the main menu will pop up from the left top of the screen. The selected main menu highlights in yellow .
2. Revolve “Menu/ Enter” to select submenu, the selected submenu highlights in yellow, press “Menu/ Enter” to apply and enter into the selected submenu’ s items.
3. Revolve “Menu/ Enter” to select the item which needed to adjust, press “Menu/ Enter”, the selected item and its parameters will be highlighted in yellow
4. Revolve “Menu/ Enter” to change the selected item’ s parameter, press “Menu/ Enter” to apply and save the settings.
5. Revolve “Menu/ Enter” to select “Exit”, press “Menu/ Enter” to quit submenu. Select “Exit & Status” under the Main Menu and press to quit Main Menu

※ Notice

- * The items in gray cannot be set up
- * If there is no operation under the set time, the menu will automatically save settings and quit.
- * If the key inhabit function is turned on, except System menu, all other items are in gray. Please turn off the key inhibit function to adjust the items.

Menu Configuration

Menu configuration introduces the main menu and each sub-menu. Menu items marked * will give more detailed menu description or operation explanation after the list

1. Input – Set the color of input video

Menu Item	Menu Description	Value
Input Range *1	Set the input range for input video	Full 0-1023 SDI Full 4-1019 Limited 64-940
Red Gain	Adjust Red Gain	-100 ~ +100
Green Gain	Adjust Green Gain	-100 ~ +100
Blue Gain	Adjust Blue Gain	-100 ~ +100
Red Bias	Adjust Red Bias	-100 ~ +100
Green Bias	Adjust Green Bias	-100 ~ +100
Blue Bias	Adjust Blue Bias	-100 ~ +100
Reset	Reset the gain and bias values of the settings	/

*1. Input range

Set the video input range to fit the input video signal. The default video input range is 64-940 for broadcast applications. The quantization range of each SDI or HDMI® channel can be individually adjusted for display when multi-screen, multi-colour gamut is selected.

2. Image *1—Setting for the picture preference

Menu Item	Menu Description	Value
Contrast	Adjust to display contrast	-100 ~ +100
Brightness	Adjust to display brightness	-100 ~ +100
Saturation	Adjust to display saturation	-100 ~ +100
Sharpness	Adjust to display sharpness	0 ~ +100
Backlight	Adjust to display backlight	0 ~ +100

*1. Image

Contrast, brightness, saturation and backlight can be quickly adjusted by the front panel shortcut keys

3. Color management—Settings about video colors

Menu Item	Menu Description	Value	
Color Gamut *1	Set gamut values	LCD Native,DCI-P3,Rec.709,Rec.2020	
Gamma*2	Set gamma values	1.0,1.8,2.2,2.4,2.6,PQ1000,HLG1000,S-Log3	
Gamut and gamma values are set to menu items with specific values	HLG System Gamma *3	Set HLG System Gamma	1.0,1.1,1.2(default),1.3,1.4,1.5
	D-Log to 709 *4	Set gamut to Rec.709 camera table	OFF,J-Log1,Log-C,S-Log2,C-Log,V-Log,RedLog-Film,S-Log3,User-Log
	D-Log to PQ	Camera table when gamut is set to Rec.2020 and gamma value is PQ1000	OFF,ARRI_LogC_PQ,Canon_CLog2Cin_PQ,Canon_CLog3Cin_PQ,Panasonic_VLog_PQ,RED_L3G10_PQ,Sony_SLog3_Cin_PQ,Sony_SLog3_SG3_PQ
	D-Log to HLG	Camera table when gamut is set to Rec.2020 and gamma value is HLG1000	OFF,ARRI_LogC_HLG,Canon_CLog2Cin_HLG,Canon_CLog3Cin_HLG,Panasonic_VLog_HLG,RED_L3G10_HLG,Sony_SLog3_Cin_HLG,Sony_SLog3_SG3_HLG
Partition HDR/SDR *5	Partition HDR/SDR On, Off	ON, OFF	
Color Temp	Set the screen to display the colour temperature value	D55, D65, D75, D93, DCI, USER1, USER2	
User Temp	Set the user color temperature value when the color temperature mode is selected as “USER 1/USER2”	4000K~9800K	
G/M	Set the user color temperature value when the color temperature mode is selected as “USER 1/USER2”	-100 ~ +100	
LUT Upload *6	Select the cube file you want to import	None,3DLut.cube,User-Log.cube	
Calibration LUT Reset	Select the appropriate cube file to restore to factory settings	NO,3DLut.cube	

*1.Color Gamut

Set the gamut to match the input audio. When Multi-screen, Multi-colour gamut, the color gamut value of the 4-channels SDI or HDMI® signal can be adjusted separately for display.

*2.Gamma

When Four-screen is selected; the gamma of 4 channels SDI or HDMI® signal can be adjusted separately for display.

*3.HLG System Gamma

Display tunable only when Gamma is set to HLG1000

*4.D-Log to 709

Display tunable only when color gamut is set to Rec.709 mode and Gamma is set to a value.

*5 Partition HDR/SDR

Individual colour gamut for Partition HDR/SDR, gamma can be adjusted individually, Partition HDR/SDR default colour gamut Rec.2020, gamma 2.2.

*6. LUT Upload

Place the cube file that needs to import the monitor in the root directory of the u-disk, insert the u-disk into the USB interface on the front shell of the monitor, and choose to import the corresponding file.

4. Scanning—Setting for picture scan, zoom, etc.

Menu Item	Menu Description	Value
Scanning Mode *1	Set up a scanning mode that matches the audio to the screen	Pixel To Pixel, Panel Fit, Original scan
Zoom-in*2	Set a zoom mode	Off, Top Left, Top, Top Right, Left, Center, Right, Bottom Left, Bottom ,Bottom Right
Freeze Frame	Select an image still mode	OFF, ON
Odd/Even Frame*3	Set to open odd field or even field	OFF, Odd Frame, Even Frame

*1.Scanning Mode

Panel Fit: Turn on this feature to adapt the video to the entire screen. Original scan:Original scans can be displayed at 4096, NTSC, PAL resolutions.

*2.Zoom -in: Shown below, the image is divided into 9 regions and adjusted to display in sequence.

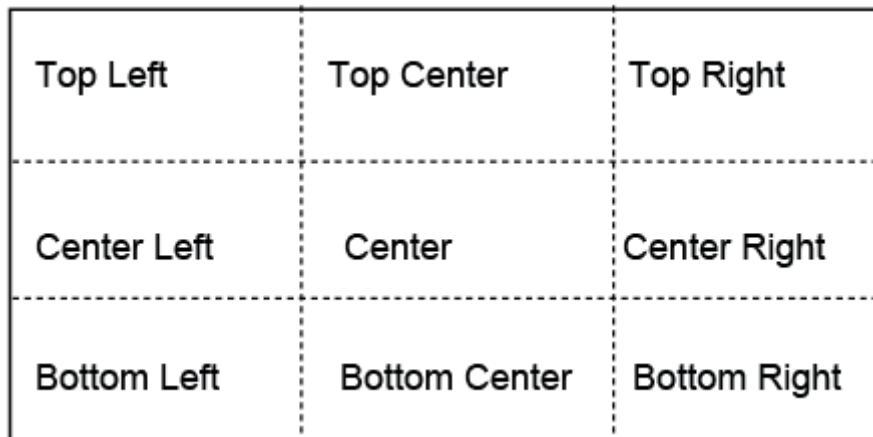

When the zoom mode is turned on, a rectangle box pops up at the bottom left of the screen, showing the currently selected zoom image area, Zoom mode on, image still frame hidden, Freeze Frame, Zoom mode function is turned off.

*3.Odd/Even Frame

Odd/Even Frame is only displayed in I mode. Open Low Latency Mode and Zoom Mode , Freeze Frame ,Odd/Even Frame function is turned off.

5.Control—Setting for TALLY, UMD, IP control to the monitor

Menu Item	Menu Description	Value
GPI Control *1	Open or close GPI Control	OFF,ON
GPI 1Pin	Set the function of each pin for GPI terminal	SFP, SDI1, SDI2, SDI3, SDI4, 4×SDI(2-SI)、4×SDI(SQ), HDMI®, Red Tally, Green Tally, Yellow Tally ,Time Code, Freeze Frame, WFM Type, WFM Single Line, UMD, Marker , Waveform, Audio Bar, Zebra, Vector, Low Latency Mode, Histogram, Lissajous, Focus Assist , False Color
GPI 2Pin		
GPI 3Pin		
GPI 4Pin		
GPI 5Pin		
GPI 6Pin		
Tally Setting	Open or close Tally lamp	OFF, ON, Blinking
Tally Position	Set the display position of On Screen Tally Lamp	Top, Bottom
F1	Set the control function of the function key	Time Code, Color Temp, Freeze Frame , Waveform, WFM Type, WFM Single Line,UMD, Marker, H/V Delay, Blue Only, Audio Bar, Zebra, Vector, Low Latency Mode, Histogram, Odd/Even Frame , Lissajous, Focus Assist ,False Color, CIE
F2		
F3		
F4		
F5		
UMD *2	Open or close UMD display	OFF, ON
UMD Color	Set the color of UMD characters	White,Red,Green,Blue,Black,Gray
UMD Position	Set the position of UMD characters	Top,Bottom
UMD Size	Set the size of UMD characters	Large, Small
UMD Blending	Show the transparency of the UMD background	OFF, LOW, HIGH
Display Type	Set display UMD or source name characters	Source ID, TSL3.1,TSL4.0
RS485 Address	Set the location of RS485	1~126
Baud Rate	Fixed for 115200	115200,8,n,1/ 38400,8,n,1/ 9600,8,n,1
Source ID	Set the character that the source name displays	A-Z, a-z, 0-9, [] ^ _ ` { } ~ @ ? > = < , / . - + * . () ' & % \$ # ' ' !

*1 GPI control

Connect the GPI remote control terminal through the GPI interface on the real panel of the monitor, turn on “GPI control” and set the function of GPI 1-6 buttons.

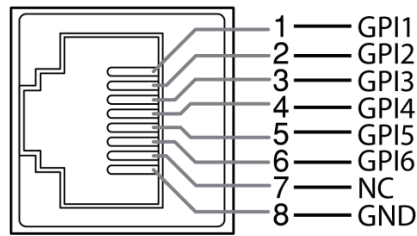

The GPI control allows you to control both the Tally light and the on screen TALLY light on at the same time:

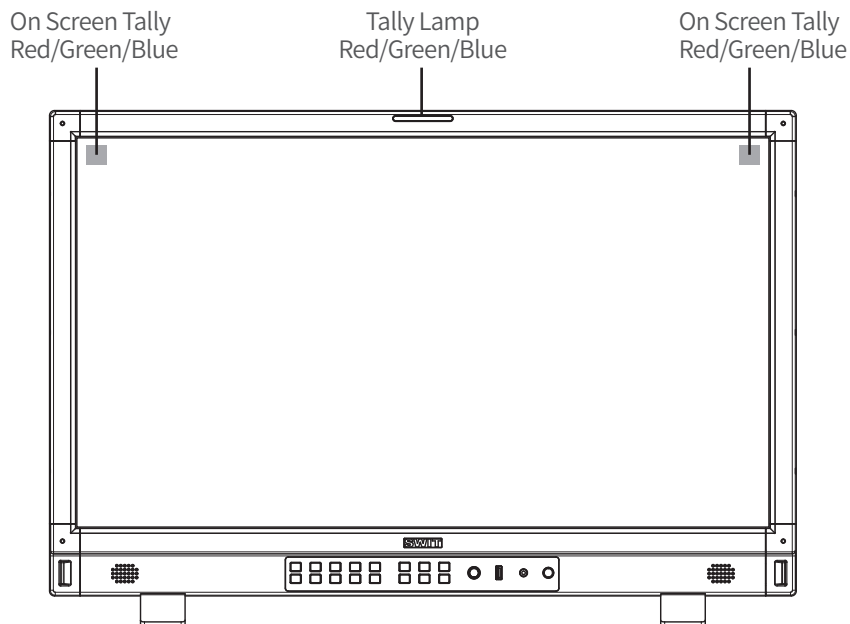

*2 UMD

Select the display type as “TSL3.1 or 4.0”, which can be controlled with TSL UMD. When selecting multiple images, each SDI or HDMI® can be displayed separately.

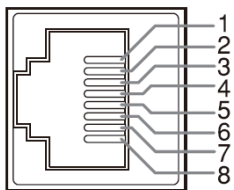

RS485 IN

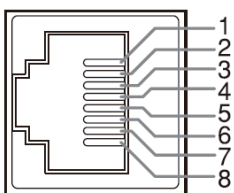

RS485 OUT

Pin No	RS 485 IN	RS 485 OUT
1	GND	GND
2	NC	NC
3	RXD-	RXD-
4	NC	NC
5	NC	NC
6	RXD+	RXD+
7	TXD-	TXD-
8	TXD+	TXD+

Cascade:

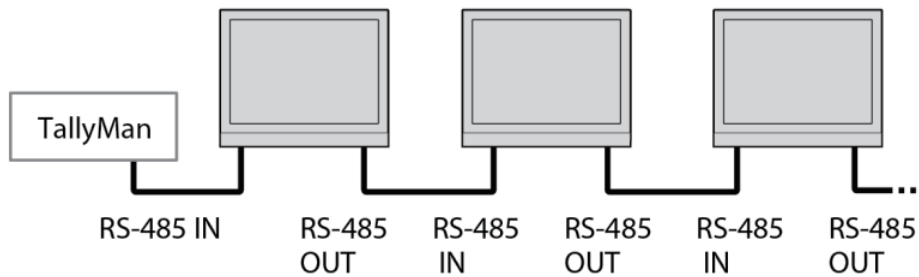

6. Assist— Setting for Vector scope and Histogram patterns.

Menu Item		Menu Description	Value
False Color		Turn false color display on or off	OFF, ON
Blue Only		Turn blue only on or off	OFF, ON
Focus Assist		Turn on or off focus assist and adjust the color of the focus assist	OFF, Blue, Red
Zebra		Turn zebra on or off	OFF, ON
Waveform	Waveform	Turn waveform on or off	OFF, ON
	WFM Type	Set the WFM Type	Y, Cb, Cr, R,G,B,RGB
	WFM Position	Set the WFM position	Bottom Left, Bottom Right, Top Left, Top Right
	WFM Blending	Set the blending of the background color of the waveform	OFF, HIGH, LOW
	WFM Bright	Set the brightness of the waveform display on the waveform graph	Low, Medium, High
	WFM Color	Set the color of the waveform displayed on the waveform chart	White, Green, Color
	WFM Single Line*1	Switch on single line waveform	OFF, ON
	WFM Line Count	Set a line for the single line waveform	1-2160
Vector	Vector	Turn vector on or off	OFF, ON
	Vector Position	Adjust the position of the vector on the screen	Bottom Left, Bottom Right, Top Left, Top Right
	Vector Blending	Vector scope transparency selection	OFF, LOW, HIGH
	Vector bright	Set the brightness within a vector image	Low, Medium, High
	Vector Color	Set vector colors	White, Green, Color

CIE	CIE	Turn the colour gamut chart on or off	On,Off
	CIE Position	Adjusting the position of the colour gamut map on the screen	Top left, Top right, Bottom left, Bottom right
	CIE Blending	Set the transparency of the background colour of the colour gamut map	Off, Low, High
	CIE Bright	Set the brightness within the colour gamut map chart	Low, Medium, High
	CIE Color	Set gamut map colours	White, green, colour
Histogram	Histogram	Turn histogram on or off	OFF, ON
	Histogram Position	Set the display position on the histogram screen	Top left, Top right, Bottom left, Bottom right
	Histogram Blending	Set the transparency of histogram background color	OFF, LOW, HIGH
Marker	Marker	Turn marker on or off	OFF, ON
	Marker Select	Set the scale of the market line	16:9,15:9,14:9,13:9,4:3,2.35:1,2:1,1.85:1,2.39:1, Custom1, Custom2
	Horizontal*2	Set the X coordinate value of the marker	50%~99% (0-3840)
	Vertical	Set the Y coordinate value of the marker	50%~99% (0-2160)
	Safety area	Set safety area percentage	80%~100%
	Fit Marker	Set safety area to fit marker ratio or not	OFF, ON
	Center Marker	Switch on the center cross marker	OFF, ON
	Marker Color	Select a color for marker	White, Red, Green, Blue, Black, Gray
	Marker line type	Set the marker line display type	Type 1, type 2
Marker Outside	Marker outside color setting	OFF, Black, Gray	
Eye Pattern *3	On or off Eye Pattern		Off, on

*1 WFM Single Line

Open waveform single-line mode, the monitor shows only one line of audio waveform. Rotate the Menu/Enter knob to select the number of lines of audio signal to display the waveform. (The selection range of the number of lines in a waveform depends on the current signal standard)

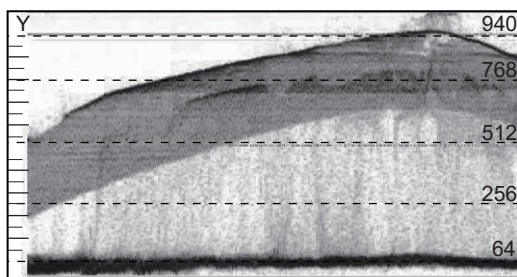

WFM Single Line:OFF

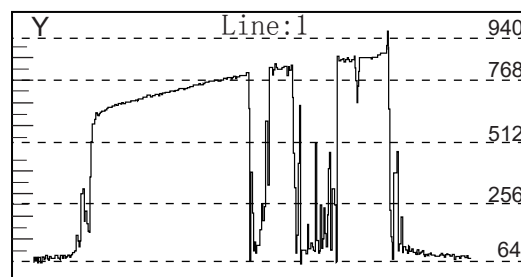

WFM Single Line:ON

*2. Horizontal / Vertical

When marker select is USER 1, Users can adjust the X position and Y position of the marking line according to their own needs, Coordinate value is adjustable from 50% to 99%; when marker select is USER2, the value of X-axis is adjustable between 0~3840, the value of Y-axis is adjustable between 0~2160.

*3 Eye Pattern

HDMI® channels do not display eye diagrams.

7. De-embed— Setting for video/audio analysis functions.

Menu Item	Menu Description	Value	
Audio Meter	Audio Meter	Turning audio meters on or off	ON,OFF
	Audio meter Position	Adjusting the position of the audio meter on the screen	Top Left, Top Right, Bottom Left, Bottom Right
	Audio meter Blending	Set the transparency of the audio meter background colour	OFF,LOW,HIGH
	Audio meter marker *1	Setting the audio meter marker line	ON,OFF
Lissajous	Lissajous Pattern	Turn on or off Lissajous figure	ON,OFF
	Lissajous position	Set the position of the Lissajous position on the screen	Top Left, Top Right, Bottom Left, Bottom Right
	lissajour Blending	Set the Blending of the Lissajous background colour	Off, Low, High
Surround Phase	Surround Phase	Turn surround Phase on or off	ON,OFF
	Surround Position	Adjusting the position of the surround sound display on the screen	Top Left, Top Right, Bottom Left, Bottom Right
	Surround type	Selecting the type of surround sound	5.1,7.1
	Surround Blending	Set the transparency of the surround sound background colour	OFF,LOW,HIGH
Left Channel*2	Select the left channel output channel	Channel 1~16	
Right Channel	Select the right channel output channel	Channel 1~16	
Volume	Adjust audio volume	0~100	
Time code*3	Turn on/off Time code	OFF, ON	
H/V Delay*4	Turn on/off H/V Delay	OFF, ON	
Closed Caption	Turn on/off Closed Caption	OFF, ON	

*1.Audio Meter Marker

Audio table display, display 16 channel audio table

Marking line off: Only the audio table is displayed

Marking line on: Display audio decibels, audio alarm signal and left and right channel options.

Marking line:off



Marking line:on

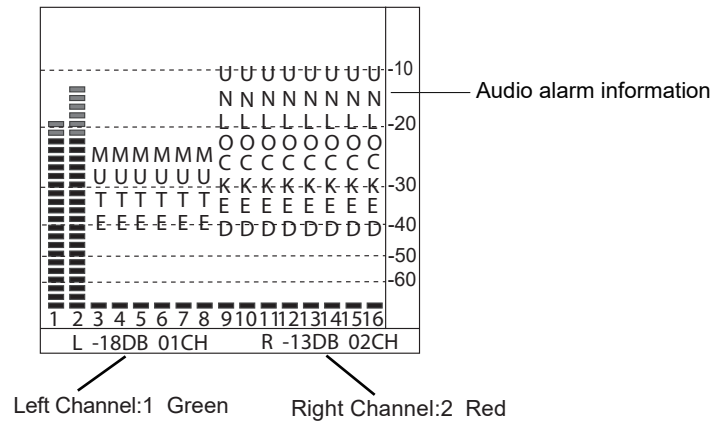

Left Channel:1 Green Right Channel:2 Red

*2. Left and right channel

When opening four-screen, the audio bar only displays four channels of sound channel is used to select the sound channel shown in the audio bar.

*3 Timecode

Time code is not displayed on HDMI® signals

*4 H/V Delay

H/V Delay is not displayed with HDMI® signals

8. Auto Calibration*1

Menu Item	Menu Description	Value
Probe Select *2	Select a probe to use	X-rite I1 Pro OEM, Jeti Specbos 1211
Start Calibration*3	Select whether to start calibration	No/Yes
Measure*4	Test current color	No/Yes

*1.Auto Calibration

The monitor has 3D LUT calibration software built-in, and supports the following color sensor probe to directly plug into front USB port. When start calibration, the monitor will generate standard colors and the color sensor will read the colors one by one and upload result to the monitor by USB connection. The monitor will comparing the generated colors and sensor read colors, to work out 3D LUT cube and calibrate itself automatically.

*2.Probe Select

This monitor supports the following probes models:

BRAND	MODE
X-rite	I1 Pro OEM (SWIT OEM)
JETI	Specbos 1211

*3.Start Calibration

Steps:

- 1、Put the monitor into a dark room. Switch on the monitor.
- 2、Connect the calibration instrument (compatible with x-rite and JETI color measuring instruments) and monitor via USB. Before calibration, ensure that the monitor and the color calibration instrument are in good condition and the monitor aging time reaches 30 minutes.
- 3、Enter the “Probe Select” and select the currently used calibration probe.
- 4、Enter the “Start Calibration” and select “YES” to start calibration. The monitor will display the prompt message and the color position prompt box. Put the sensitive part of the device in the color position prompt box correctly. Note that when placing the calibration instrument; do not squeeze the monitor’s LCD screen.

Auto Calibration
 Please make sure the monitor is in dark room, and the sensor probe is put in the center marker and close to the screen.
 Select MENU to start!
 MENU:OK INFO:Quit

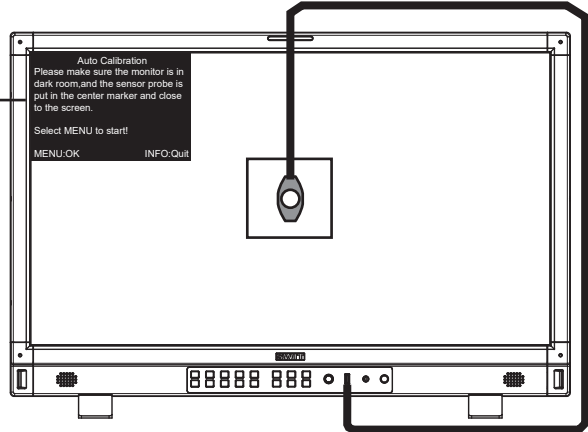

5. Select " YES " to begin auto calibration. The color calibration instrument will automatically measure the color of the screen and correct the color of the screen. During this process, it is necessary to observe the color calibration progress bar in the color correction prompt box.

Auto Calibration
 Progress 23%
 Please wait...
 Select INFO to Cancel!
 INFO: Quit

6. Press "Info/Quit" to terminate the color correction process at any time. When the prompt color calibration progress reaches 100%, the whole automatic color calibration is completed. After automatic color correction, press the " Info/Quit " button to exit the menu and let the monitor enter the normal display mode.

7. After the automatic color correction, the display screen pops up "Before Calibration" and "After Calibration".

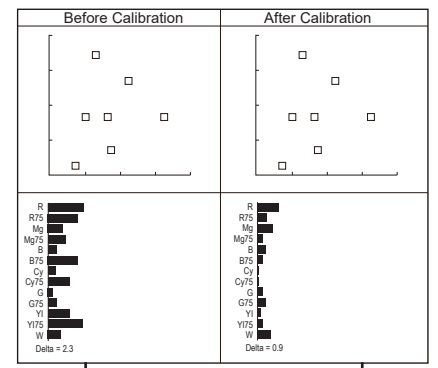

CIE and Delta E before calibration CIE and Delta E after calibration

***4. Measure**

The monitor has been calibrated in factory. And may need to be re-calibrated after a period of time. Before re-calibrated, the measure function can check the current color to compare with the last time calibrated color, to decide if the monitor needs to be re-calibrated. Connect with the sensor probe and place the sensor probe onto the right position like calibration step. Enter "Auto Calibration" – "Measure". The monitor will generate several colors and finish measure within 30 seconds. And display the result as:

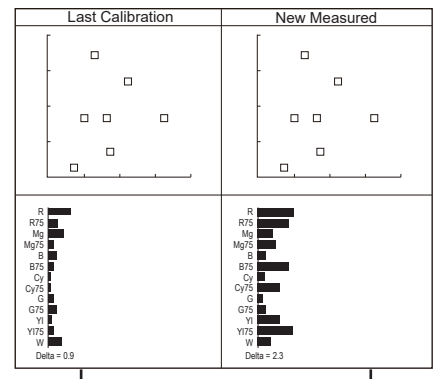

CIE and Delta E result of last calibration CIE and Delta E result of new measured

9. System— User profile saving, firmware update.

Menu Item	Menu Description	Value
Key Lock *1	Set lock key	OFF, Full Lock
Recall Profile*2	Select make user mode current	Factory,USER1,USER2,USER3,USER4
Save Profile	Save the current state as a user setting	USER1,USER2,USER3,USER4
Payload ID	When turned on, Payload ID information conforming to SMPTE ST 352 standard is automatically adapted	OFF, ON
Low Latency Mode*3	Open or close low latency mode	OFF, ON
Green mode	Set the display mode of green mode	Black Backlight, Gray Backlight
Idle Duration	Set how long it will be in the no-signal state and turn on green mode	30 Sec, 1 Hour, 2 Hours, 4 Hours, OFF
IP *4	Set up the monitor IP address to achieve remote web control	192.168.001.200
Net Mask		255.255.255.000
Gateway		192.168.001.001
Port(1024~65535)		08080
OSD TIME	Set OSD display time	5~180
Key Brightness	Set the brightness of the key lamp	OFF, Low, High
Status Switch	Turn on or off status display	OFF, ON
Language	Select Chinese or English language to display	中文, English
System Reset	Reset all Settings in the menu system	No/Yes
Update *5	Set whether to update firmware	No/Yes

*1.Key Lock

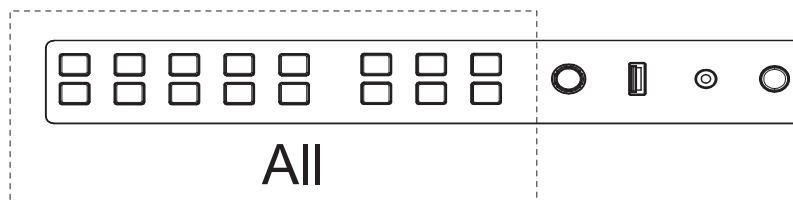

The “Menu/Enter” button can be operated when the button is locked. “Key Locked” will be displayed on the screen when you press the Locked button or knob.



*2 Recall Profile/ Save Profile

User Settings provide 4 menu Settings, that is, users can save the current monitor menu Settings as one user Settings (USER1~USER4) according to usage habits. Then, when switching menu Settings, just select the corresponding "USER1~USER4" through the "Recall Profile" item to display the corresponding menu Settings.

Example: By adjusting the parameters of the color temperature of 2200K, open the necessary auxiliary functions (such as: histogram), set the function key to the desired menu (such as F1 is set to "Blue Only"), and so on, the monitor Menu Settings can be "USER Settings" save as "USER" 1, rotating the "Menu/Enter" choose to load the USER Settings "set to the current" USER 1 "mode, the monitor Menu item value will show" USER 1 "mode to save Menu.

*3. Low Latency Mode

Low Latency Mode is a special image processing mode for lip-sync monitoring.

For progressive (p) formats, the monitor is low latency itself, whether low latency mode is on or off. For interlace (I) or progressive segmented Frame (psd) formats, turn on Low Latency Mode will get lower latency.

Video/Audio Latency Stable		
SDI Format	Close lower latency	Open lower latency
4096×2160 60P	0.01frame	0.01 frame
4096×2160 50P	0.1 frame	0.1 frame
4096×2160 30P	0.51 frame	0.51 frame
4096×2160 25P	0.6 frame	0.6 frame
4096×2160 24P	0.6 frame	0.6 frame
3840×2160 60P	0.01 frame	0.01 frame
3840×2160 50P	0.1 frame	0.1 frame
3840×2160 30P	0.51 frame	0.51 frame
3840×2160 25P	0.6 frame	0.6 frame
3840×2160 24P	0.6 frame	0.6 frame
2048×1080 60P	0.01 frame	0.01 frame
2048×1080 50P	0.1 frame	0.1 frame
2048×1080 30P	0.51 frame	0.51 frame
2048×1080 25P	0.6 frame	0.6 frame
2048×1080 24P	0.6 frame	0.6 frame
1080 60P	0.01 frame	0.01 frame
1080 50P	0.1 frame	0.1 frame
1080 30P	0.51 frame	0.51 frame
1080 25P	0.6 frame	0.6 frame
1080 24P	0.6 frame	0.6 frame
1080 24PSF	2 frame	0.6 frame
1080 60I	2 frame	0.01 frame
1080 50I	2 frame	0.1 frame
720 60I	0.01 frame	0.01 frame
720 50I	0.1 frame	0.1 frame

*4. IP control

Connect the monitor to the LAN through an ETHERNET interface, and the Monitor can be controlled by web page.

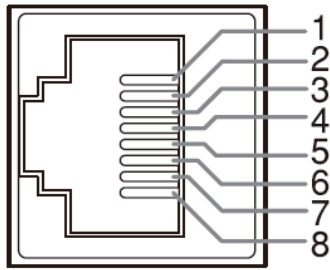

ETHERNET

Pin No	Pin Name
1	MD0P
2	MD0N
3	MD1P
4	MD1N
5	MD2P
6	MD2N
7	MD3P
8	MD3N

Enter Menu- System – IP/Net Mask/Gateway/Port to set the monitor address. Set the computer Ethernet IP addresses at the same LAN environment as the Monitor.

Launch any of a web browser on the computer, and enter URL: Monitor IP+ Port (Example: 192.168.1.99.8080). The web server control page will be displayed.

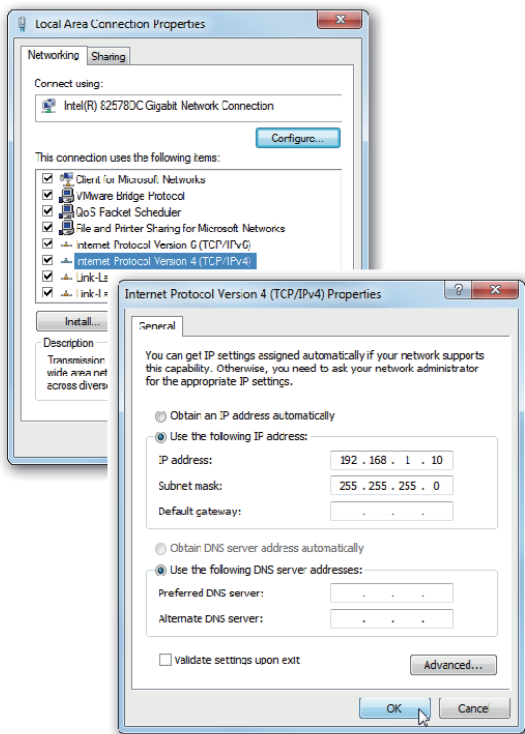
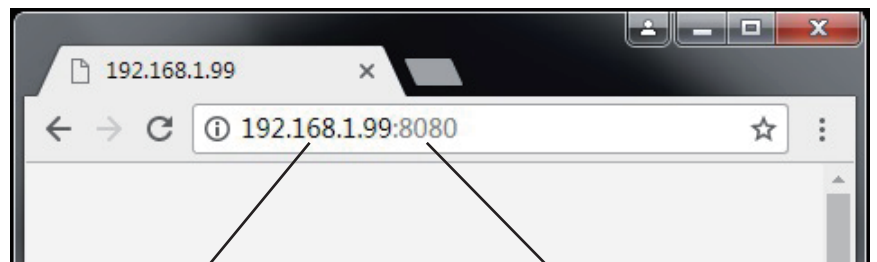

Fig1: IP Address setting



Monitor IP address

Monitor port address

Fig2: Web page

- ⊙ Used crossed wired cable for computer-monitor directly connection.
- ⊙ Use straight-through wired cable for Router connections.
- ⊙ Please seek help from your webmaster for any network connections.

*5.Update

System software can update by USB interface, and steps are as follows:

- 1.Download the latest software package into the U-disk root direction.
- 2.Open the monitor and plug U-disk into USB into port.
- 3.Follow the step “Menu-System“, the monitor will update automatically.
- 4.When update finishes, press “Power” button, close and reboot the monitor.

<p style="text-align: center; font-weight: bold; font-size: 1.2em;">FIRMWARE UPDATE</p> <p>Please put the firmware file into USB disk root directory ,and Prese MENU to start!</p> <p style="font-size: 1.1em;">MENU:OK INFO: Quit</p>	<p>※ Remark</p> <ol style="list-style-type: none"> 1. Only copy one model and software version into the U-disk root direction. 2. Never shutdown the power during the update progress.
---	--

Webserver page control interface

SWIT.
BM-U series

Status

Settings

Network

Update

Input Source: HDMI

Input Format: 1920*1080P60
Loaded Profile: USER 1

Video Level Range: 64-940
YUV Color Matrix: BT.709

Volume: 18

Chroma: 0

Bright: 0

Contrast: 0

Freeze Frame: OFF

Odd/Even Frame: OFF

Low Latency: OFF

Gamma: 2.2

Color Temp: D65

Log Mode: OFF

Monitor IP: 192.168.1.200
Net Mask: 255.255.255.0

Gateway: 192.168.1.1

Port: 8080

Refresh Status

Input Source: SDI1 SDI2 SDI3 SDI4 SQ 2-SI SFP +21.11

Loaded Profile: USER 1

Function Key: F1 F2 F3 F4 F5 F6

Volume: 0 100

Chroma: -100 100

Brightness: -100 100

Contrast: -100 100

Frame: Freeze Frame TopHalf BottomHalf Full

Odd/Even Frame Odd Even

Low Latency ON OFF

Color: VideoLevelRange [64-940] YUVColorMatrix [Auto]

Gamma [2.2] Color Temp [D65]

Settings

Network

Update

Monitor IP:

Net Mask:

Gateway:

Port: 1024-65535

Settings

Network

Update

Current Version:

Notes:

1. Please make sure you have the update zip package on your PC.
2. Recommend to do Firmware updates only with AC power support.
3. Never shutdown the power during updating progress.

Please following these instructions:

Search a new update zip package on your PC: 未选择文件.

Press 'submit' to transfer it to the monitor:

Now ready to install, press 'Update':

10. Multi-screen settings *1

Menu Item	Menu Description	Item values
Multi-screen type*2	Select multiview type	Quad View,PBP,PIP
PIC 1	For 2 screens and picture-in-picture, select the channel displayed for screens 1 and 2	SDI1~4, HDMI®
PIC 2		
PIP Window Position	Select PIC2 position when set to PIP	Bottom Left, Bottom Right , Top Left, Top Right, Centre
Border	Switch on/off the border	ON,OFF

*1 Multi-screen settings

Selecting the button Source in Multi-screen for the Multi-screen settings to be adjustable; some menus are hidden in Multi-screen;

When Multi-screen is selected for the channel, the quantization range, colour gamut, gamma, UMD and Payload ID of each screen can be adjusted separately.

*2 Multi-screen type

If there is no signal on the 4th SDI channel input, an HDMI® signal appears on the 4th channel.

Size

Monitor (unit: mm)

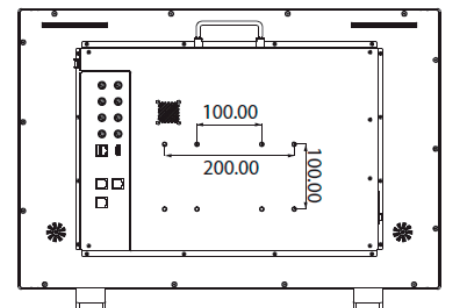
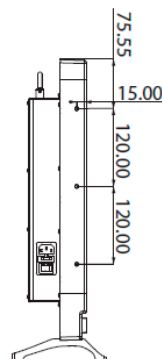
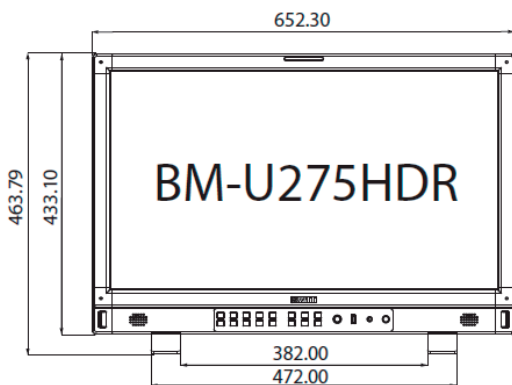
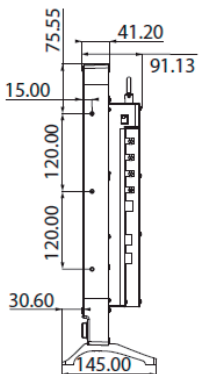
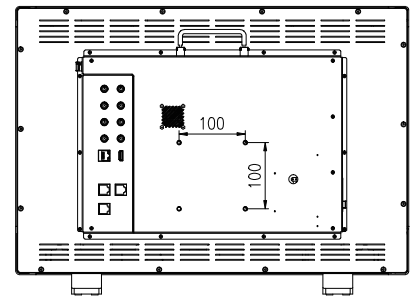
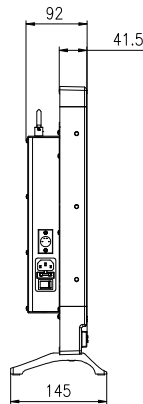
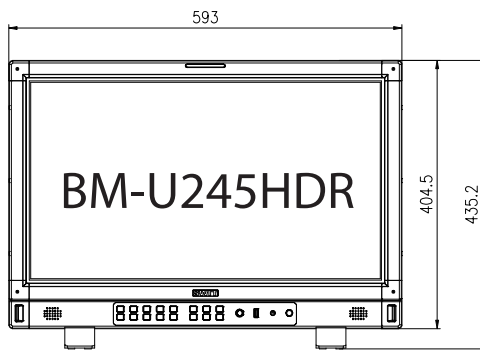
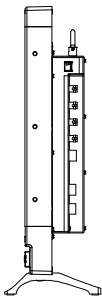
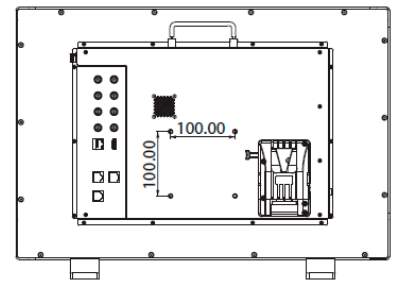
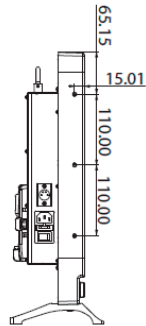
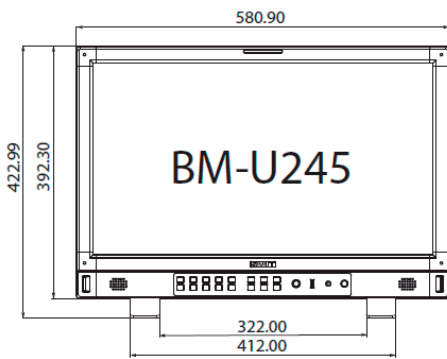
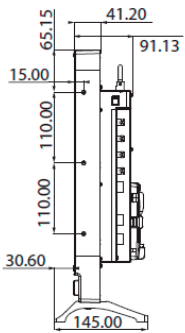
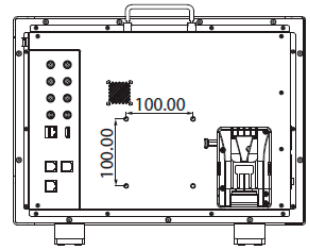
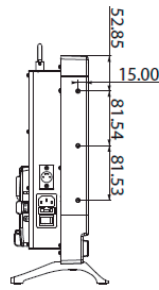
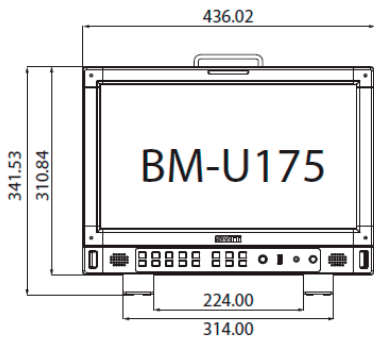
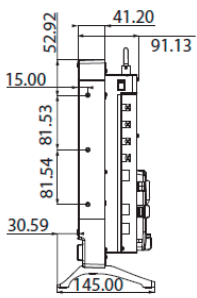

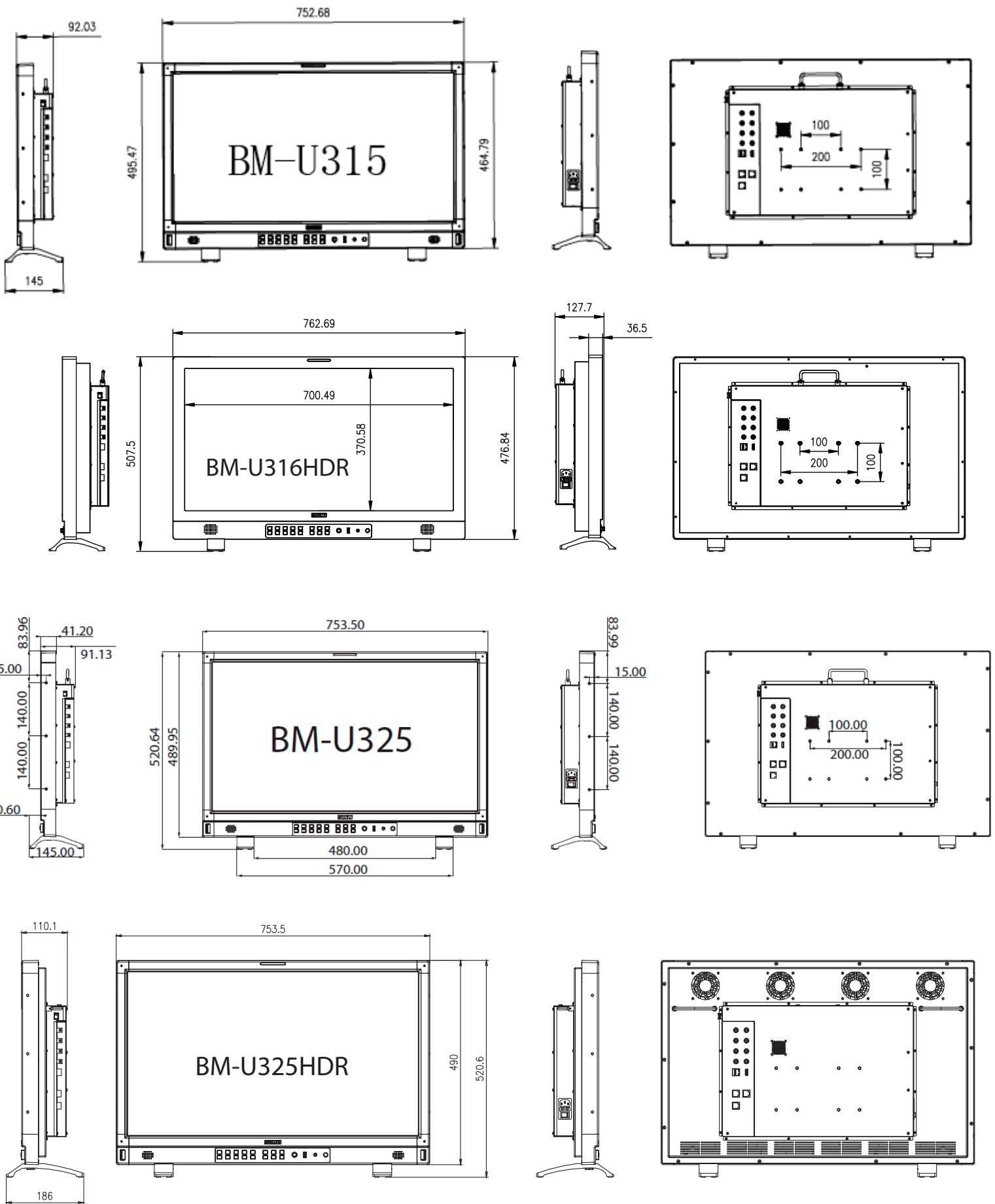

※ BM-U175, BM-U245 ,BM-U245HDRhas battery plate in the back, support battery powering.
 BM-U175, BM-U245 ,BM-U245HDRcan install 100*100 pitch-row VISA bracket.
 BM-U275HDR, BM-U315, BM-U325,BM-U325HDR,BM-U316HDR can install 100*100 or100*200
 pitch-row VISA bracket.

Specification

LCD Performance				
Model	BM-U175	BM-U245	BM-U245HDR	BM-U275HDR
Size	17.3	23.8	23.8	27
Display area	381.88×214.82mm	527.04×296.46mm	527.04×296.46mm	596.74×335.66mm
Resolution	3840*2160	3840*2160	3840*2160	3840*2160
Display Color	16.7M	1.07G	16.7M	1.07G
Display ratio	16:9	16:9	16:9	16:9
Brightness	300	300	1300 cd/m ²	1000 cd/m ²
Contract	800:1	1500:1	1000:1	1400:1
Viewing Angle	Horizontal/Vertical: 178°/178°	Horizontal/Vertical: 178°/178°	Horizontal/Vertical: 178°/178°	Horizontal/Vertical: 178°/178°
Input /Output				
Input	BNC×4	12G/6G/3G/HD/SD-SDI		
	HDMI®×1	HDMI® input		
	RS-485×2	GPI×1.UMD×1		
	USB×1			
	ETHERNRT			
Output	BNC×4	12G/6G/3G/HD/SD-SDI		
	RS-485×1	UMD×1		
Other specification				
Working voltage	AC:100V~240V			AC:100V~240V
	DC Battery:12V~17V			
Power consumption	60W	70W	120W	130W
Working temperature	0°C~+50°C			
Working humidity	10%~90%			
Storage temperature	- 15°C~ + 60°C			
Storage humidity	10%~90%			
Dimensions (mm)	436×310.8×89	581×392×89	593×405×92	652×433×89
Net weight (w/o stand)	5.90KG	8.87KG	10.2 KG	11.0KG

Specification

LCD Performance				
Model	BM-U315	BM-U325	BM-U325HDR	BM-U316HDR
Size	31.1	31.5	31.5	31.4
Display area	697.96×368.06mm	698.40×392.85mm	697.31×392.23mm	697.958 × 368.064 mm
Resolution	4096*2160	3840*2160	3840*2160	4096*2160
Display Color	1.07G	1.07G	1.07G	1.07G
Display ratio	17:9	16:9	16:9	16:9
Brightness	350 cd/m ²	300 cd/m ²	1500 cd/m ²	850 cd/m ²
Contract	1500:1	3000:1	1000:1	1000:1
Viewing Angle	Horizontal/Vertical: 178°/178°	Horizontal/Vertical: 178°/178°	Horizontal/Vertical: 178°/178°	Horizontal/Vertical: 178°/178°
Input /Output				
Input	BNC×4	12G/6G/3G/HD/SD-SDI		
	HDMI®×1	HDMI® input		
	RS-485×2	GPI×1.UMD×1		
	USB×1			
	ETHERNRT			
Output	BNC×4	12G/6G/3G/HD/SD-SDI		
	RS-485×1	UMD×1		
Other specification				
Working voltage	AC:100V~240V			
Power consumption	120W	80W	200W	210W
Working temperature	0°C~+50°C			
Working humidity	10%~90%			
Storage temperature	- 15°C~ + 60°C			
Storage humidity	10%~90%			
Dimensions (mm)	753×465×89	754×490×89	754×490×110	763×477×128
Net weight (w/o stand)	13KG	12KG	16 KG	19.56KG

Supported Format: Signals below can display on the monitor

No.	Format	Input terminal			Signal format shown in the Status Display as	
		SDI1~4 & SFP	Multiview	HDMI®	SDI1~4&SFP	HDMI®
1	1280×720/50P	√	—	√	1280*720P50	1280*720P50
2	1280×720/59.94P	√	—	√	1280*720P59.94	1280*720P60
3	1280×720/60P	√	—	√	1280*720P60	1280*720P60
4	1920×1080/50I	√	√	√	1920*1080I50	1920*1080I50
5	1920×1080/59.94I	√	√	√	1920*1080I59.94	1920*1080I60
6	1920×1080/60I	√	√	√	1920*1080I60	1920*1080I60
7	1920×1080/23.98PSF	√	√	√	1920*1080PSF23.98	1920*1080PSF24
8	1920×1080/24PSF	√	√	√	1920*1080PSF24	1920*1080PSF24
9	1920×1080/23.98P	√	√	√	1920*1080P23.98	1920*1080P24
10	1920×1080/24P	√	√	√	1920*1080P24	1920*1080P24
11	1920×1080/25P	√	√	√	1920*1080P25	1920*1080P25
12	1920×1080/29.97P	√	√	√	1920*1080P29.97	1920*1080P30
13	1920×1080/30P	√	√	√	1920*1080P30	1920*1080P30
14	1920×1080/48P	√	√	—	1920*1080P48	—
15	1920×1080/50P	√	√	√	1920*1080P50	1920*1080P50
16	1920×1080/59.94P	√	√	√	1920*1080P59.94	1920*1080P60
17	1920×1080/60P	√	√	√	1920*1080P60	1920*1080P60
18	2048×1080/23.98PSF	√	√	√	2048*1080PSF23.98	2048*1080PSF24
19	2048×1080/24PSF	√	√	√	2048*1080PSF24	2048*1080PSF24
20	2048×1080/25PSF	√	√	√	2048*1080PSF25	2048*1080PSF25
21	2048×1080/29.97PSF	√	√	√	2048*1080PSF29.97	2048*1080PSF30
22	2048×1080/30PSF	√	√	√	2048*1080PSF30	2048*1080PSF30
23	2048×1080/23.98P	√	√	√	2048*1080P23.98	2048*1080P24
24	2048×1080/24P	√	√	√	2048*1080P24	2048*1080P24
25	2048×1080/25P	√	√	√	2048*1080P25	2048*1080P25
26	2048×1080/29.97P	√	√	√	2048*1080P29.97	2048*1080P30
27	2048×1080/30P	√	√	√	2048*1080P30	2048*1080P30
28	2048×1080/47.94P	√	√	—	2048*1080P47.94	—
29	2048×1080/48P	√	√	—	2048*1080P48	—
30	2048×1080/50P	√	√	√	2048*1080P50	2048*1080P50
31	2048×1080/59.94P	√	√	√	2048*1080P59.94	2048*1080P60
32	2048×1080/60P	√	√	√	2048*1080P60	2048*1080P60
33	3840×2160/23.98P	√	√	√	3840*2160P23.98	3840*2160P24
34	3840×2160/24P	√	√	√	3840*2160P24	3840*2160P24
35	3840×2160/25P	√	√	√	3840*2160p25	3840*2160p25
36	3840×2160/29.97P	√	√	√	3840*2160P29.97	3840*2160P30
37	3840×2160/30P	√	√	√	3840*2160P30	3840*2160P30
38	3840×2160/47.94P	√	√	—	3840*2160P47.94	—
39	3840×2160/48P	√	√	—	3840*2160P48	—

No.	Format	Input terminal			Signal format shown in the Status Display as	
				HDMI®	SDI1~4&SFP	HDMI®
40	3840×2160/50P			√	3840*2160P50	3840*2160P50
41	3840×2160/59.94P			√	3840*2160P59.94	3840*2160P60
42	3840×2160/60P			√	3840*2160P60	3840*2160P60
43	4096×2160/23.98P			√	4096*2160P23.98	4096*2160P24
44	4096×2160/24P			√	4096*2160P24	4096*2160P24
45	4096×2160/25P			√	4096*2160P25	4096*2160P25
46	4096×2160/29.97P			√	4096*2160P29.97	4096*2160P30
47	4096×2160/30P			√	4096*2160P30	4096*2160P30
48	4096×2160/47.94P			—	4096*2160P47.94	—
49	4096×2160/48P			—	4096*2160P48	—
50	4096×2160/50P			√	4096*2160P50	4096*2160P50
51	4096×2160/59.94P			√	4096*2160P59.94	4096*2160P60
52	4096×2160/60P			√	4096*2160P60	4096*2160P60

3G supports level A/level B; Support RGB444

√: The format is supported
 —: The format is not supported

Trouble-shooting

symptom	Possible causes	Solution
No display	The power is not turned on	Please check if the power is connected, and then press “POWER” button to turn on the monitor
	Unstable power voltage	Reconnect to power supply
	BNC or HDMI® cable loose contact or not correctly connected	Check and correctly connect the BNC or HDMI®
	The attached battery is no power	change cable
	Using DIY power supply but the polarity is reversed	Change battery
Image or color abnormal	Bad contact of BNC or HDMI® cable	Change the Video cable
	Video signal has Interference	Remove the interference source(s)
	Improper adjustment of the color parameters	Adjust the “Recall profile” to “Default” under “System” submenu
	Distortion of the image	Reset the Aspect ratio
	Set to Blue only	Turn off the “pure color “ setting
	Turn on the “Focus Assist” function	Turn off the “Focus Assist” function
	Turn on the “False Color” function	Turn off the “False Color” function
No audio output	Set mute state	Cancel mute state or spin ” MENU/ENTER ” to adjust volume
	Bad contact of signal cable	Change signal cable
	Wrong connection or bad contact of Audio cable	Connect to the correct input socket

SWIT®

SWIT Electronics Co., Ltd.

Add: 10 Hengtong Road, Xin'gang, Nanjing Economic and Technological Development Zone, Nanjing 210038, P.R.China
Tel: +86-25-85805753 Email: contact@swit.cc

SWIT Electronics Europe GmbH

Add: Hochstr. 17, 47228 Duisburg, Germany
Tel: +49(0)20659799339 Email: info@swit-europe.com

SWIT Electronics America, Inc

Add: 3350 Scott Boulevard 61-02, Santa Clara, CA 95054, USA
Tel: (408)260-8258, 1-866-986-SWIT(7948) Email: info@swit.us
