

LITEMONS

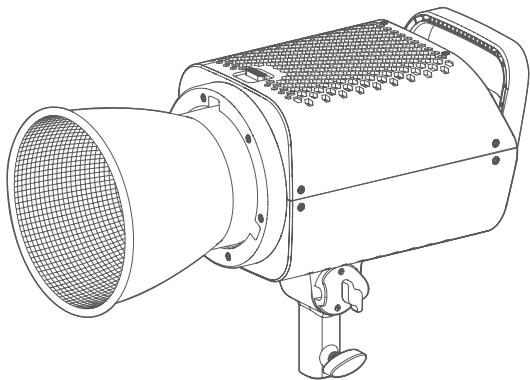

LA150R LA200R LA300R

光小兽全彩 LED 直播灯
LITEMONS Full-color LED Light

使用手册
Instruction Manual

重要的安全说明及注意事项

首先作为最基本原则：本产品为专业灯光布景设备，应由专业灯光师使用或在专业人士指导下使用。使用时必须始终遵循基本的安全预防措施，具体安全预防措施如下：

1. 使用前必须阅读并理解产品说明书。
2. 专业灯具，禁止儿童使用。当儿童靠近时，家长或监护人必须密切监督，以免儿童因碰撞灯具或私用灯具造成人身伤害。
3. 本灯具并非普通照明灯具，不可用于普通照明，任何有过眼部损伤或眼部敏感的人群均应避免使用本灯具。
4. 灯具点亮时，必须小心使用，禁止接触高温部件，如 LED 灯珠，以免造成灼伤。
5. 灯具点亮时，任何情况下均禁止直视灯珠。应该在专业灯光师指导下使用强光，任何情况下避免长时间处于强光环境，如引起眼睛不适，请及时关闭灯具，暂停使用，请及时就医。
6. 倘灯珠损坏或因热变形，应停止使用，并及时联系制造商、服务代理商或合格的维修人员更换灯珠，以免发生意外。
7. 本产品仅适用于 $-20^{\circ}\text{C} \sim 40^{\circ}\text{C}$ 工作环境温度及正常湿度环境下使用。
8. 请勿使用损坏的设备或设备配件，待专业维修人员检查维修，确认设备正常方可使用。
9. 在使用过程中，如果本产品由于跌落、受到挤压或遭受强烈冲击而造成外壳破裂的，请勿继续使用，以免因接触到内部电子元件而受到电击伤害。
10. 如需要延长线，请使用额定电流 \geq 该设备额定电流的延长线。如延长线额定电流小于该设备，可能导致过热。
11. 部分产品电源线较长，请合理放置电源线，使其处于安全位置。避免电源线接触过热物体表面、避免放置不当导致拉扯损坏或绊倒现场人员。请使用本厂原装电源线，如使用非本厂电源线导致产品损坏，一概不在本厂维修范围内。
12. 在清洁和维修之前，请务必从电源插座上拔下该设备插头。不使用时，禁止拉扯电源线以将设备插头从电源插座中拔出。正常断电，应是用手抓住该设备插头两端，将插头从电源插座中拔出。此设备需连接到接地插座中。
13. 本设备没有防水性能，请让设备保持干燥，请勿将本设备浸入水中或其他液体中。设备需安装在干燥且通风处，避免在雨天、潮湿、多尘或过热环境下使用。请勿将任何物体置于灯具上或使液体流入灯具内部，以免发生意外。
14. 请勿私自拆卸产品，如产品出现故障，须由本公司或授权的维修人员进行检查维修。
15. 存放本设备之前，请确保设备已完全冷却。存放时，将电源线从设备上拔出。设备应放置于设备便携包内或通风干燥处。
16. 请勿将设备放置在酒精、汽油等易燃易爆挥发的溶剂附近。
17. 本厂不推荐的产品附件，请勿使用，以免导致火灾、触电或人身伤害。
18. 清洁本设备时，请勿用湿布擦拭，请用干布，软布擦拭设备污垢。
19. 设备使用前，请注意将保护罩取下。
20. 本产品已通过 ROHS, CE 和 FCC 认证，请参考相关国家标准使用和操作。

21. 安全说明依据本厂严格测试制定, 设备设计和规格如有变更, 恕不另行通知。客户可以上神牛官网查看最新的电子版说明, 了解产品最新资讯。
22. 一年保修期, 消耗品电池、适配器、电源线等配件不在此保修范围内。
23. 经发现, 擅自检修设备, 将取消一年保修期, 维修需要收取相关费用。
24. 对于不规范操作引起的机器故障不在保修范围内。

保存这些说明

前言

感谢您购买神牛产品!

神牛全新推出全彩 LED 摄影灯 LA150R (输入 165W), LA200R (输入 220W), LA300R (输入 330W), 三款产品除功率不同外, 都以拥有多种模式如 CCT/HSI/RGBW/GEL/FX 光效, NFC 加灯功能, 内置蓝牙可远程操控产品, 宽广色温 1800K-10000K, 亮度可调, 灯珠高亮高显, 支持百分级调光等特性能更好地应对拍摄工作, 全彩 RGBW 模式让不同光色随着主题变化而打造相应氛围; 专为小场景广告, 微电影拍摄以及直播布光等场景提供光源。

警告

- ⚠️ 大功率 LED 灯, 严禁直视光源或照射他人眼睛。
- ⚠️ 严禁通电时插拔电源线, 以免造成人身伤害。
- ⚠️ 本灯具工作时, 请勿遮挡散热口。
- ⚠️ 请勿让儿童靠近、接触或使用本灯具。
- ⚠️ 专业灯光设备, 请务必按照使用手册正确操作。



请勿直视光源

本设备包含型号核准代码为: CMIIT ID: 24J44V807298, 为该产品的无线电发射模块。

部件名称

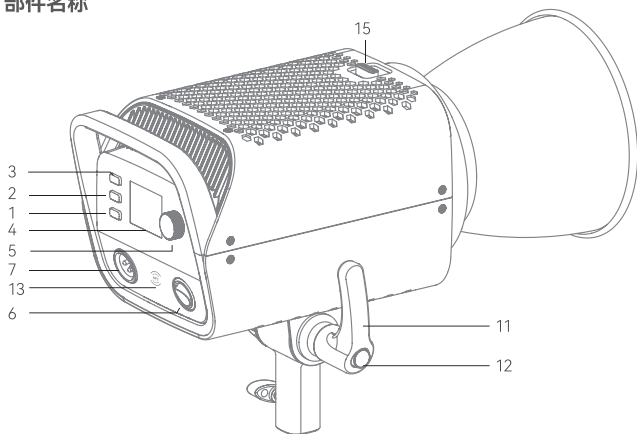

1. 蓝牙按键
2. MENU 按键
3. MODE 按键
4. 显示屏
5. 调节旋钮
6. 开关按键
7. DC 输入接口
8. 伞孔
9. 伞孔锁紧旋钮
10. 支架锁紧旋钮
11. 调节把手
12. 调节把手按钮
13. NFC 感应区域
14. 保荣卡口
15. 卡口推制

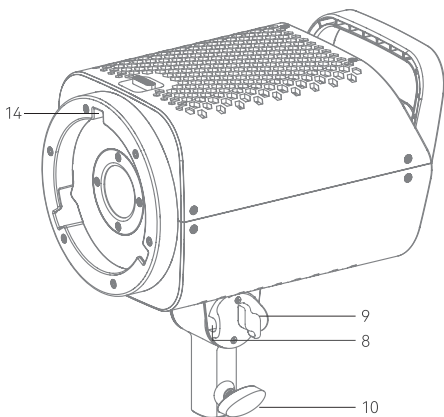

LA150R / LA200R / LA300R 物料清单

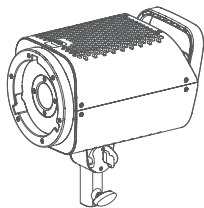

灯体 × 1

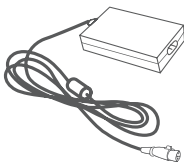

适配器 × 1



AC 电源线 × 1



钢丝绳 × 1

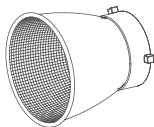

反光罩 BR30 × 1



说明书 × 1

LA150R K1 / LA200R K1/ LA300R K1 物料清单

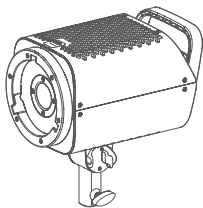

灯体 × 1

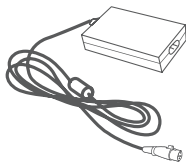

适配器 × 1



AC 电源线 × 1



钢丝绳 × 1

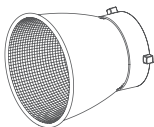

反光罩 BR30 × 1

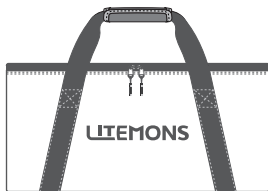

单灯收纳包 × 1



说明书 × 1

LA300R 3K 物料清单

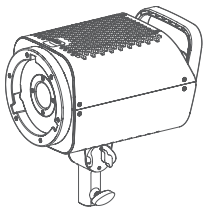

灯体 × 3

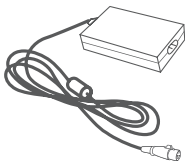

适配器 × 3



三灯收纳包 × 1



AC 电源线 × 3



钢丝绳 × 3

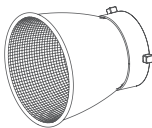

反光罩 BR30 × 3



说明书 × 1

温馨提示：说明书中线图均为示意图，仅供参考。由于产品不断更新与升级，产品实物与线图可能存在差异，请以实物为准。

安装 / 拆卸反光罩

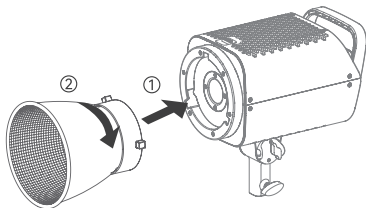

1. 将反光罩对准灯头卡口，插入后顺时针旋转即可安装完毕。

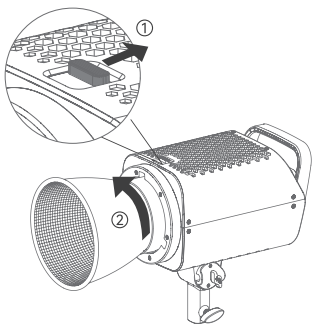

2. 按住卡口推制，逆时针旋转即可取下灯头反光罩。

安装灯架

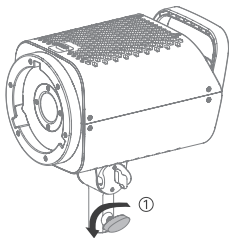

逆时针拧松支架锁紧旋钮，将灯具稳固安装于落地灯架，再将支架锁紧旋钮顺时针拧紧即可。

注：灯架需要另购

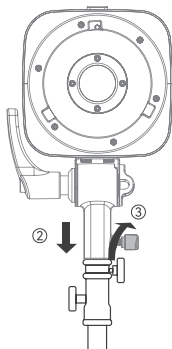

开机 / 关机

接通电源，拨动开关按键至 (I) 实现开机，拨动开关按键至 (O) 实现关机。

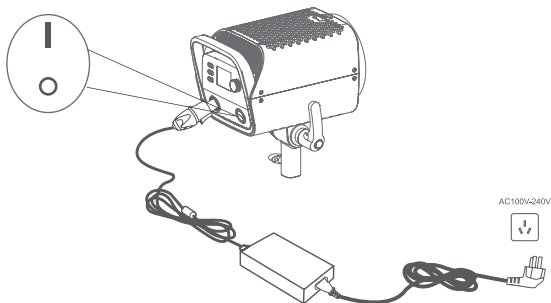

CCT 模式

短按 MODE 按键进入模式选择，选中 CCT 后短按调节旋钮进入该模式，可选亮度 / 色温 / 绿品 GM。通过短按并旋转调节旋钮设置参数值，顺时针旋转递增参数值，逆时针旋转递减参数值。

亮度范围：0% ~ 100%

色温范围：1800K ~ 10000K

GM 范围：-100% ~ +100%

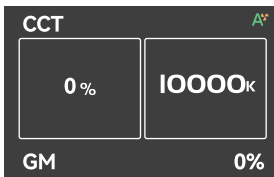

HSI 模式

短按 MODE 按键进入模式选择，选中 HSI 后短按调节旋钮进入该模式，可选亮度 / 色相 / 饱和度。通过短按并旋转调节旋钮设置参数值，顺时针旋转递增参数值，逆时针旋转递减参数值。

亮度范围：0% ~ 100%

色相范围：0 ~ 360

饱和度范围：0% ~ 100%

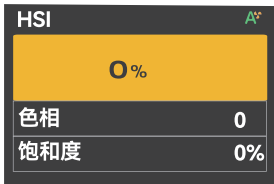

RGBW 模式

短按 MODE 按键进入模式选择，选中 RGBW 后短按调节旋钮进入该模式，可选亮度 / 红光 / 绿光 / 蓝光 / 白光。通过短按并旋转调节旋钮设置参数值，顺时针旋转递增参数值，逆时针旋转递减参数值。

亮度范围：0% ~ 100%

红光范围：0% ~ 100%

绿光范围：0% ~ 100%

蓝光范围：0% ~ 100%

白光范围：0% ~ 100%

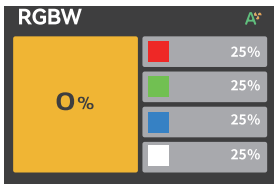

GEL 模式

短按 MODE 按键进入模式选择，选中 GEL 后短按调节旋钮进入该模式，可选亮度 / 色片类型 / 色片组类型 / 颜色选择 / 色温 / 色相 / 饱和度。通过短按并旋转调节旋钮设置参数值，顺时针旋转递增参数值，逆时针旋转递减参数值。

亮度范围：0% ~ 100%

色片类型：ROSCO/LEE

色片组类型 (ROSCO)
Color correction/CalColor/Storaro Selection/Cinelux

色片组类型 (LEE)
Color correction/Color Filters/600 Series/Cosmetic Filters/700 Series

色温：3200K 或 5600K

色相范围：-10 ~ 10

饱和度范围：-20% ~ 20%

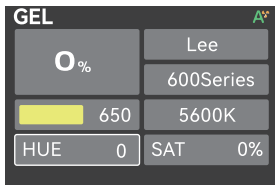

FX 模式

短按 MODE 按键进入模式选择，选中 FX 后短按调节旋钮进入该模式，可选光效有 14 类：闪光灯 / 雷闪电 / 多云 / 坏灯泡 / 电视机 / 蜡烛 / 火 / 烟花 / 爆炸 / 焊接 / 警车 / SOS / 彩光循环 / 派对。通过短按并旋转调节旋钮设置某个光效的参数值，顺时针旋转递增参数值，逆时针旋转递减参数值。

1. 闪光灯

此光效模拟闪光灯闪光或传统镁光灯闪光，常用于营造一种生动、活泼的氛围。

亮度：0% -100% (以 1% 为增量)

开关：开启 / 关闭

触发：A 自动 / M 手动

颜色：CCT/HSI

色温 / 色相：1800K-10000K/0-360°

速度：1-100

模式：闪光灯 / 镁光灯

2. 雷闪电

此光效模拟雷电的闪电，常用于营造一种紧张、恐怖或神秘的氛围。

亮度：0% -100%（以1%为增量）

开关：开启 / 关闭

触发：A 自动 /M 手动

色温：1800K-10000K

闪烁次数：随机 /1-10

频率：随机 /2-20

3. 多云

此光效模拟云层遮挡效果，常用于营造一种阴沉、压抑或悲伤氛围。

亮度：0% -100%（以1%为增量）

开关：开启 / 关闭

亮暗比例：30%-90%

速度：随机 /1-100

4. 坏灯泡

此光效模拟一盏损坏的灯泡闪光，常用于营造昏黄的环境氛围。

亮度：0% -100%（以1%为增量）

开关：开启 / 关闭

颜色：CCT/HSI

色温 / 色相：1800K-10000K/0-360°

速度：1-100

5. 电视机

此光效模拟电视机或屏幕的光线效果，常用于营造出一种冷淡、机械或数字化的氛围。

亮度：0% -100%（以1%为增量）

开关：开启 / 关闭

颜色：CCT/HSI

速度：1-100

6. 蜡烛

此光效模拟蜡烛的光线效果，常用于营造出一种柔和、温暖、闪烁的氛围。

亮度：0% -100%（以 1%为增量）

开关：开启 / 关闭

速度：1-100

7. 火

此光效模拟火焰的光线效果，常用于营造出一种明亮、热烈、闪烁氛围。

亮度：0% -100%（以 1%为增量）

开关：开启 / 关闭

速度：1-100

8. 烟花

此光效模拟烟花的光线效果，常用于营造出一种绚丽、多彩、浪漫的氛围。

亮度：0% -100%（以 1%为增量）

开关：开启 / 关闭

余烬：1-100

速度：1-100

9. 爆炸

此光效模拟爆炸的光线效果，常用于营造出一种明亮、猛烈、闪烁氛围。

亮度：0% -100%（以 1%为增量）

开关：开启 / 关闭

触发：A 自动 /M 手动

颜色：CCT/HSI

色温 / 色相：1800K-10000K/0-360°

余烬：1-100

速度：1-100

10. 焊接

此光效模拟焊接的光线效果，常用于营造出一种炽热、机械的氛围。

亮度：0% -100%（以1%为增量）

开关：开启 / 关闭

颜色：CCT/HSI

色温 / 色相：1800K-10000K/0-360°

速度：1-100

11. 警车

此光效模拟警车灯光的闪烁效果，常用于营造紧张、追逐或紧张氛围。

亮度：0% -100%（以1%为增量）

开关：开启 / 关闭

颜色：红 + 蓝、红、蓝、蓝 + 白、蓝 + 黄、黄、红 + 白 + 蓝、红 + 黄 + 蓝

模式：1-5

12. SOS SOS

此光效模拟 SOS 求救信号的闪烁效果，常用于营造危险、求救或紧急情况氛围。

亮度：0% -100%（以1%为增量）

开关：开启 / 关闭

颜色：CCT/HSI

色温 / 色相：1800K-10000K/0-360°

13. 彩光循环

此光效模拟模拟彩色光线的循环和变化效果，常用于营造一种梦幻、科幻的氛围。

亮度：0% -100%（以1%为增量）

开关：开启 / 关闭

饱和度：0%-100%

速度：1-100

14. 派对

此光效模拟彩色光线、闪光灯和激光等效果，常用于营造出一种狂欢、欢乐、高能氛围。

亮度：0% -100%（以 1%为增量）

开关：开启 / 关闭

饱和度：0%-100%

速度：1-100

注：根据需求旋转调节旋钮设置当前参数值，设置完毕后短按并旋转调节旋钮可跳入下一栏参数进行设置；选中 M 手动时，通过短按一次调节旋钮触发一次该光效；某个光效设置完毕后短按 MODE 按键回到 14 类光效选择界面。

菜单设置

短按 MENU 按键进入菜单界面，旋转并短按调节旋钮可进入图中各选项的设置。



1. 蓝牙

短按调节旋钮进入蓝牙设置，旋转调节旋钮选择蓝牙开启 / 关闭 / 复位，蓝牙 MAC 码位于右下角方便查找灯具蓝牙，设置完毕短按 MENU 按键返回菜单界面。



快捷蓝牙重置:

您可以长按蓝牙按键进行蓝牙重置，持续长按时界面出现 Reset 进度条，当进度条拉满后即处于蓝牙重置中。

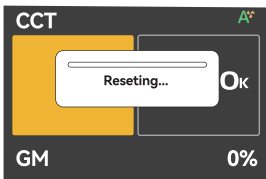
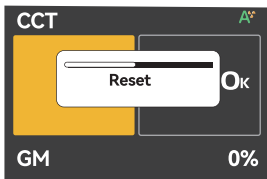

“GODOX Light”App 下载

扫描下面二维码即可下载“Godox Light”手机 app（安卓和苹果系统都可以使用）。

1. 首个移动设备（手机或平板电脑）可直接使用 app 操控灯体。更换其他移动设备时，灯体需进行蓝牙重置方可正常使用 app。
2. App 需升级至 V3.0 以上版本。



2. 风扇

短按调节旋钮进入风扇设置，旋转调节旋钮可选静音 / 自动 / 中速 / 高速，设置完毕短按 MENU 按键返回菜单界面。



3. 屏幕设置

短按调节旋钮进入屏幕设置，旋转调节旋钮可设置屏幕亮度，逆旋递减亮度，顺旋递增亮度，可设置范围：10%-100%，设置完毕短按 MENU 按键返回菜单界面。

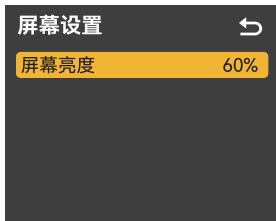

4. 语言

短按调节旋钮进入语言设置，旋转调节旋钮可选简体中文 /English，设置完毕短按 MENU 按键返回菜单界面。



5. 版本与升级

短按调节旋钮进入版本与升级，此界面可查看升级步骤以及右下角的固件版本号，查看完毕短按 MENU 按键返回菜单界面。

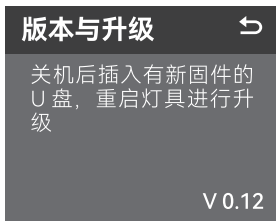

6. 恢复出厂设置

短按调节旋钮进入恢复出厂设置，旋转调节旋钮可选确定 / 取消，当您确定恢复出厂设置，灯具将自动重启，界面会出现简体中文和 English 选项，设置您需要的语言后灯体亮度值自动变为 100% 且界面来到 CCT 模式。



7. 灯具信息

短按调节旋钮进入灯具信息，此界面可查看产品型号 / 固件版本 / 灯头温度信息，查看完毕短按 MENU 按键返回菜单界面。



NFC 加灯

通过手机 NFC 功能与灯具 NFC 芯片相互通信后完成快速添加灯具到【Godox light】App 中。

1、前置条件：灯具支持 NFC 添加、【Godox light】App 版本 V3.2.4 以上、手机开启蓝牙和 NFC 功能。

2、使用方法：前置条件成立情况下，打开【Godox light】进入对应场景中，点击【+】选择【NFC 加灯】功能，进入【NFC 添加设备】页面将手机 NFC 感应区靠近灯具感应区即可完成加灯，支持多灯添加。

注意：Android 系统直接靠近感应加灯，iOS 需点击右上角（）图标后出现弹窗感应加灯。

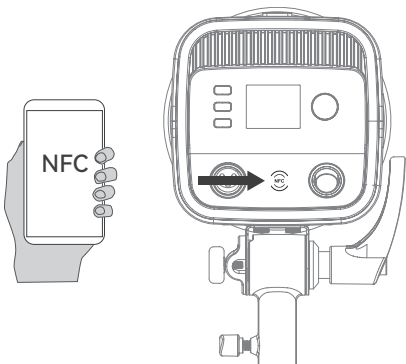

维护保养

- 一年保修期，消耗品电池，适配器，电源线等配件不在此保修范围内。
- 经发现，擅自检修此灯，将取消该产品一年保修期，维修需要收取相关费用。
- 对于不规范操作引起的机器故障不在保修范围内。
- 所有维修一概由本厂指定的可供原配件的维修部负责。
- 如本品出现故障或者被水淋湿，在专业人员维修后方可继续使用。
- 灯具在工作时，如发现异常，应立即关掉电源，查明原因。

照度数据

LA150R

色温	测试条件	照度单位	1m	3m	5m
1800K	裸灯	lux	≈ 2438	≈ 272	≈ 93
		fc	≈ 225	≈ 25	≈ 9
2800K		lux	≈ 5270	≈ 613	≈ 229
		fc	≈ 489	≈ 57	≈ 21
3200K		lux	≈ 5490	≈ 637	≈ 239
		fc	≈ 510	≈ 59	≈ 22
4300K		lux	≈ 5370	≈ 619	≈ 233
		fc	≈ 498	≈ 58	≈ 22
5600K		lux	≈ 5060	≈ 582	≈ 217
		fc	≈ 471	≈ 54	≈ 20
6500K		lux	≈ 4960	≈ 571	≈ 213
		fc	≈ 461	≈ 53	≈ 20
8500K		lux	≈ 4750	≈ 546	≈ 204
		fc	≈ 441	≈ 51	≈ 19
10000K		lux	≈ 4640	≈ 534	≈ 200
		fc	≈ 431	≈ 50	≈ 19
红光		lux	≈ 1190	≈ 124	≈ 46
		fc	≈ 110	≈ 12	≈ 4
绿光		lux	≈ 1849	≈ 209	≈ 79
		fc	≈ 172	≈ 19	≈ 7
蓝光	lux	≈ 589	≈ 68	≈ 26	
	fc	≈ 55	≈ 6	≈ 2	

色温	测试条件	照度单位	1m	3m	5m
1800K	标配反光罩 BR30	lux	≈ 27968	≈ 2502	≈ 883
		fc	≈ 2602	≈ 233	≈ 82
2800K		lux	≈ 54400	≈ 4960	≈ 1720
		fc	≈ 5050	≈ 461	≈ 160
3200K		lux	≈ 57100	≈ 5070	≈ 1770
		fc	≈ 5300	≈ 471	≈ 164
4300K		lux	≈ 55500	≈ 4940	≈ 1720
		fc	≈ 5150	≈ 459	≈ 160
5600K		lux	≈ 52900	≈ 4660	≈ 1620
		fc	≈ 4910	≈ 433	≈ 151
6500K		lux	≈ 51400	≈ 4560	≈ 1580
		fc	≈ 4780	≈ 424	≈ 147
8500K		lux	≈ 49300	≈ 4370	≈ 1510
		fc	≈ 4580	≈ 406	≈ 141
10000K		lux	≈ 48200	≈ 4290	≈ 1480
		fc	≈ 4480	≈ 398	≈ 138
红光		lux	≈ 12880	≈ 1168	≈ 411
		fc	≈ 1196	≈ 109	≈ 38
绿光		lux	≈ 20332	≈ 1840	≈ 636
		fc	≈ 1895	≈ 171	≈ 59
蓝光	lux	≈ 6010	≈ 554	≈ 191	
	fc	≈ 559	≈ 52	≈ 18	

LA200R

色温	测试条件	照度单位	1m	3m	5m
1800K	裸灯	lux	≈ 2646	≈ 298	≈ 110
		fc	≈ 246	≈ 28	≈ 10
2800K		lux	≈ 6430	≈ 731	≈ 274
		fc	≈ 603	≈ 68	≈ 25
3200K		lux	≈ 6620	≈ 758	≈ 282
		fc	≈ 615	≈ 71	≈ 26
4300K		lux	≈ 6520	≈ 748	≈ 279
		fc	≈ 606	≈ 70	≈ 26
5600K		lux	≈ 6210	≈ 711	≈ 265
		fc	≈ 577	≈ 66	≈ 25
6500K		lux	≈ 6060	≈ 697	≈ 259
		fc	≈ 563	≈ 65	≈ 24
8500K		lux	≈ 5850	≈ 673	≈ 250
		fc	≈ 543	≈ 63	≈ 23
10000K		lux	≈ 5720	≈ 661	≈ 246
		fc	≈ 532	≈ 61	≈ 23
红光	lux	≈ 1284	≈ 143	≈ 54	
	fc	≈ 200	≈ 13	≈ 5	
绿光	lux	≈ 1999	≈ 227	≈ 86	
	fc	≈ 186	≈ 21	≈ 8	
蓝光	lux	≈ 623	≈ 70	≈ 26	
	fc	≈ 58	≈ 6	≈ 2	

色温	测试条件	照度单位	1m	3m	5m
1800K	标配反光罩 BR30	lux	≈ 31066	≈ 2822	≈ 980
		fc	≈ 2891	≈ 263	≈ 91
2800K		lux	≈ 65900	≈ 5930	≈ 2050
		fc	≈ 6120	≈ 552	≈ 190
3200K		lux	≈ 68000	≈ 6070	≈ 2110
		fc	≈ 6320	≈ 564	≈ 196
4300K		lux	≈ 67300	≈ 5970	≈ 2070
		fc	≈ 6250	≈ 554	≈ 192
5600K		lux	≈ 64000	≈ 5850	≈ 1980
		fc	≈ 5950	≈ 544	≈ 184
6500K		lux	≈ 62800	≈ 5560	≈ 1930
		fc	≈ 5830	≈ 517	≈ 180
8500K		lux	≈ 60600	≈ 5380	≈ 1880
		fc	≈ 5630	≈ 500	≈ 175
10000K		lux	≈ 59400	≈ 5280	≈ 1830
		fc	≈ 5520	≈ 93	≈ 170
红光	lux	≈ 14014	≈ 1303	≈ 452	
	fc	≈ 1303	≈ 122	≈ 42	
绿光	lux	≈ 21854	≈ 1999	≈ 691	
	fc	≈ 2029	≈ 186	≈ 64	
蓝光	lux	≈ 6290	≈ 561	≈ 195	
	fc	≈ 585	≈ 52	≈ 18	

LA300R

色温	测试条件	照度单位	1m	3m	5m
1800K	裸灯	lux	≈ 3050	≈ 328	≈ 123
		fc	≈ 283	≈ 31	≈ 11
2800K		lux	≈ 9930	≈ 1120	≈ 415
		fc	≈ 922	≈ 104	≈ 39
3200K		lux	≈ 10100	≈ 1140	≈ 425
		fc	≈ 935	≈ 106	≈ 40
4300K		lux	≈ 9750	≈ 1110	≈ 414
		fc	≈ 905	≈ 103	≈ 39
5600K		lux	≈ 9210	≈ 1030	≈ 392
		fc	≈ 856	≈ 96	≈ 36
6500K		lux	≈ 8430	≈ 964	≈ 358
		fc	≈ 783	≈ 90	≈ 33
8500K		lux	≈ 7510	≈ 859	≈ 319
		fc	≈ 698	≈ 80	≈ 40
10000K		lux	≈ 7200	≈ 822	≈ 396
		fc	≈ 669	≈ 76	≈ 37
红光	lux	≈ 1560	≈ 176	≈ 66	
	fc	≈ 145	≈ 16	≈ 6	
绿光	lux	≈ 2100	≈ 238	≈ 89	
	fc	≈ 195	≈ 22	≈ 8	
蓝光	lux	≈ 766	≈ 86	≈ 32	
	fc	≈ 71	≈ 8	≈ 3	

色温	测试条件	照度单位	1m	3m	5m
1800K	标配反光罩 BR30	lux	≈ 36600	≈ 3340	≈ 1160
		fc	≈ 3400	≈ 310	≈ 107
2800K		lux	≈ 100000	≈ 8990	≈ 3100
		fc	≈ 9310	≈ 835	≈ 288
3200K		lux	≈ 102000	≈ 9170	≈ 3160
		fc	≈ 9450	≈ 852	≈ 294
4300K		lux	≈ 99800	≈ 8930	≈ 3080
		fc	≈ 9270	≈ 830	≈ 286
5600K		lux	≈ 94700	≈ 8450	≈ 2910
		fc	≈ 8800	≈ 785	≈ 271
6500K		lux	≈ 86300	≈ 7640	≈ 2630
		fc	≈ 8020	≈ 710	≈ 245
8500K		lux	≈ 77100	≈ 6850	≈ 2370
		fc	≈ 7160	≈ 636	≈ 220
10000K		lux	≈ 73900	≈ 6580	≈ 2280
		fc	≈ 6870	≈ 611	≈ 211
红光		lux	≈ 17400	≈ 1590	≈ 548
		fc	≈ 1610	≈ 147	≈ 51
绿光	lux	≈ 22800	≈ 2070	≈ 716	
	fc	≈ 2120	≈ 193	≈ 67	
蓝光	lux	≈ 7860	≈ 699	≈ 238	
	fc	≈ 730	≈ 65	≈ 22	

以上数据均为平均值，非绝对值，以上测试皆在灯体 100%亮度下进行。

规格参数

型号	LA150R	LA200R	LA300R
输入功率	165W	220W	330W
供电	100V-240V ~ 50/60Hz		
色温	1800K-10000K		
品红 / 绿调节	-100% ~ 100%		
调光范围	0%-100%		
CRI	平均 \geq 95		
TLCI	平均 \geq 94		
蓝牙控制距离	最远 30 米		
工作环境温度	-20°C ~ 40°C		
尺寸 (不含反光罩)	\approx 231mm \times 156mm \times 238mm		
净重 (不含反光罩)	\approx 2.5kg		

设计和规格如有变更，恕不另行通知。

Safety Instructions and Attentions

First of all, as the most basic principle: This product is a professional lighting set equipment and should be used by professional lighting engineers or under the guidance of professionals. Basic safety attentions must always be followed during use, as follows:

1. Before use, please read and understand these instructions and attentions.
2. Professional lighting is prohibited for children. When children are near, parents or accompanying persons must supervise closely to prevent children from personal injury due to collision with lamps or private use of lamps.
3. This lighting product is not ordinary lighting product and cannot be used for general lighting. Anyone who has suffered eye damage or has sensitive eyes should avoid using this product.
4. When the lamp is on, it must be used with care. Do not touch high-temperature parts, such as LED lamp beads, to avoid burns.
5. When the lamp is on, it is forbidden to look directly at the lamp beads under any circumstances. Strong light should be used under the guidance of professional lighting engineers. Avoid prolonged exposure to strong light under any circumstances. If eye discomfort, please turn off the lamp in time, suspend use, and see a doctor immediately.
6. If the lamp bead is damaged or deformed by heat, stop using this equipment, and contact the manufacturer, service agent or qualified maintenance personnel to replace the lamp bead in time to avoid accidents.
7. This product is only suitable for use in -20°C to 40°C operating environment and normal humidity environment.
8. Do not use damaged equipment or accessories, and wait for professional maintenance personnel to check and repair to confirm being normal before use.
9. During using, if the casing of this product is broken due to being dropped, squeezed or subjected to strong impact, please do not use it, so as to avoid electric shock injury due to contact with internal electronic components.
10. If an extension cord is required, please use an extension cord with a current rating greater than or equal to that of the equipment. If an extension cord is rated less than the equipment, overheating may result.
11. Some products have long power cords, please place the power cords properly and keep them in a safe place. Avoid contacting the power cord with overheating surfaces, avoid improper placement that could cause pulling damage, or trip on-site personnel. Please use the certified power cord from the original manufacturer. If the product is damaged by using a non-certified power cord, it will not be repaired by our factory.

12. Be sure to unplug equipment from the power outlet before cleaning and repairing. When not in use, do not pull the power cord to unplug the equipment. For normal power-off, please hold both ends of the plug of the equipment with your hands and pull the plug out of power outlet. This equipment needs to be connected to a grounded outlet.
13. This equipment is not waterproof, please keep it dry and do not immerse it in water or other liquids. The equipment should be installed in a dry and ventilated place, and avoid using it in rainy, humid, dusty or overheated environments. Do not place any objects on the lamp or let liquid flow into the lamp to avoid accidents.
14. Do not disassemble the product without permission. If the product fails, it must be checked and repaired by authorized maintenance personnel.
15. Before storing, make sure that the equipment has cooled down completely. For storage, unplug the power cord from the equipment. The equipment should be placed in the carrying case or in a ventilated dry place.
16. Do not place equipment near flammable and volatile solvents such as alcohol and gasoline.
17. Do not use accessories that are not recommended by our factory to avoid fire, electric shock or personal injury.
18. When cleaning, do not wipe it with a damp cloth, please use a dry cloth or a soft cloth to wipe the dirt of the equipment.
19. Please take off the protective cover before using.
20. This product complies with ROHS, CE and FCC certification, please refer to the relevant national standards for use and operation.
21. The safety instructions are formulated according to the strict testing of the factory, and the design and specifications of the equipment are subject to change without prior notice. For latest product information, please check the GODOX website and view latest electronic instruction.
22. One-year warranty period, accessories such as consumable batteries, adapters, power cords, etc. are not covered by this warranty.
23. If it is found that the equipment is repaired without authorization, the one-year warranty period will be cancelled and relevant fees will be charged for maintenance.
24. Machine failures caused by non-standard operation are not covered by the warranty.





Keep these instructions!

Foreword

Thank you for purchasing!

Brand new LITEMONS LED lights LA150R (input 165W), LA200R (input 220W), and LA300R (input 330W) have the following prominent features: CCT/HSI/RGBW/GEL/FX modes, NFC fixture addition function, remote control through built-in Bluetooth, wide CCT range from 1800K to 10000K, adjustable brightness, high-bright light bead, percentage dimming and etc. Full-color RGBW mode allows different light colors to create the appropriate atmosphere as the shooting theme changes. It is specially designed to provide light source for small scene advertising, microfilm shooting, live streaming and other scenes.

Warning

-  Do not look directly at the LED light or illuminate at others' eyes.
-  Do not plug or unplug the power cable or connecting cable when the power is turned on, otherwise personal injuries may occur.
-  Do not cover the heat dissipation vent in working status.
-  Keep out of reach of children.
-  Please make sure to follow the instruction manual and correctly use this professional lighting device.



Do not stare at the operating light source

Names of Parts

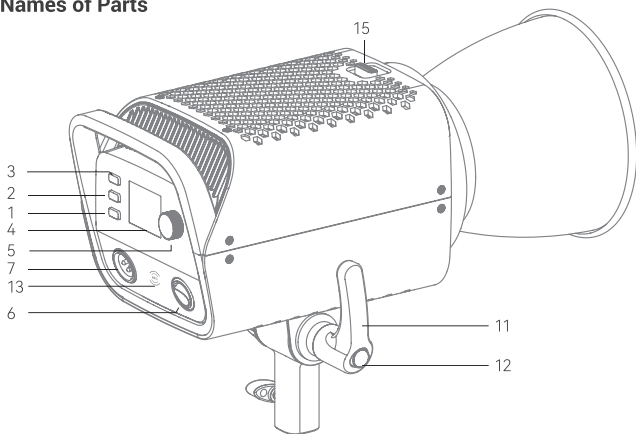

1. Bluetooth Button
2. MENU Button
3. MODE Button
4. Display
5. Select Dial
6. Power Switch
7. DC Input Port
8. Umbrella Hole
9. Umbrella Hole Locking Knob
10. Bracket Locking Knob
11. Adjusting Handle
12. Adjusting Handle Button
13. NFC Sensing Area
14. Bowens Mount
15. Mount Fixing Pusher

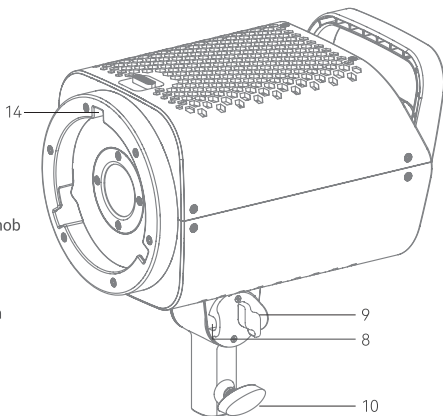

Item List for LA150R / LA200R / LA300R

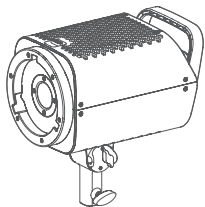

Light Body × 1

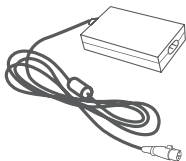

Adapter × 1



AC Power Cord × 1



Wire Rope × 1

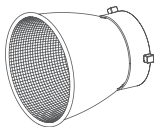

Reflector BR30 × 1



Instruction Manual × 1

Item List for LA150R K1/ LA200R K1/ LA300R K1

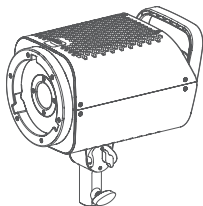

Light Body × 1

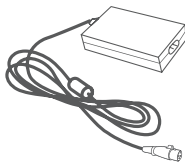

Adapter × 1



AC Power Cord × 1



Wire Rope × 1

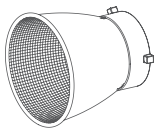

Reflector BR30 × 1

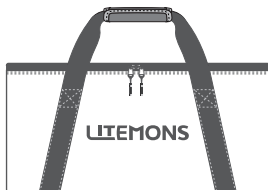

Storage Bag × 1



Instruction Manual × 1

Item List for LA300R 3K

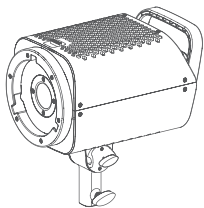

Light Body × 3

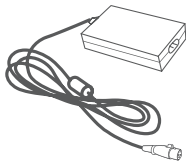

Adapter × 3



Storage Bag × 1



AC Power Cord × 3



Wire Rope × 3

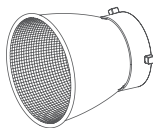

Reflector BR30 × 3



Instruction Manual × 1

Note: Due to continuous updates and upgrades of the products, there may be differences between the actual products and the pictures. Therefore, the pictures are for reference only, products to prevail in kind.

Installing/Detaching Reflector

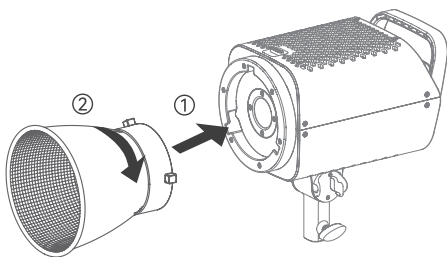

1. Align the reflector with the light head mount and rotate clockwise to install it.

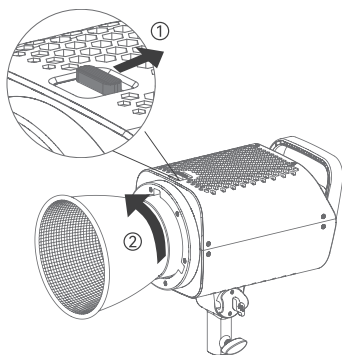

2. Press and hold the mount fixing pusher and rotate counterclockwise to remove the reflector.

Installing the Bracket

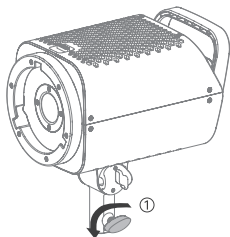

Rotate counterclockwise the bracket locking button to loosen it, install the light body onto the bracket firmly, then rotate clockwise the bracket locking button to tighten it.

Note: the bracket is sold separately.

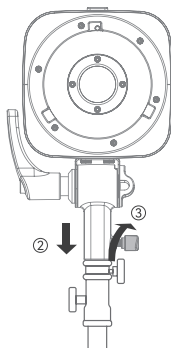

Power Switch

Connect to the power source, toggle the power switch to **|** to turn on the device, toggle it to **○** to turn off the device.

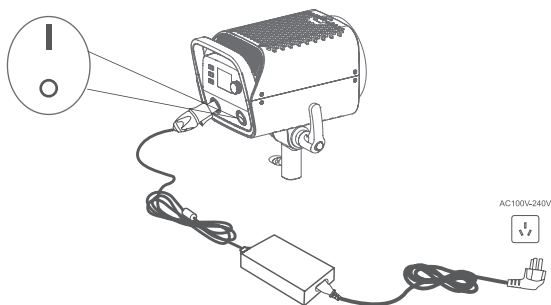

CCT Mode

Press the MODE button to enter mode selection, turn and press the select dial to choose CCT mode. Turn and press the select dial to adjust brightness, CCT and GM values, turn clockwise to increase while turn anticlockwise to decrease.

Brightness: 0% ~ 100%

CCT: 1800K ~ 10000K

GM: -100% ~ +100%

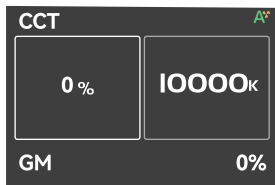

HSI Mode

Press the MODE button to enter mode selection, turn and press the select dial to choose HSI mode. Turn and press the select dial to adjust brightness, HUE and SAT values, turn clockwise to increase while turn anticlockwise to decrease.

Brightness: 0% ~ 100%

HUE: 0 ~ 360

SAT: 0% ~ 100%

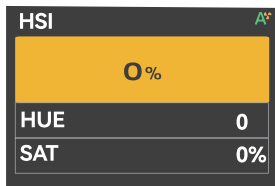

RGBW Mode

Press the MODE button to enter mode selection, turn and press the select dial to choose RGBW mode. Turn and press the select dial to adjust brightness, red, green, blue and white values, turn clockwise to increase while turn anticlockwise to decrease.

Brightness: 0% ~ 100%

Red: 0% ~ 100%

Green: 0% ~ 100%

Blue: 0% ~ 100%

White: 0% ~ 100%

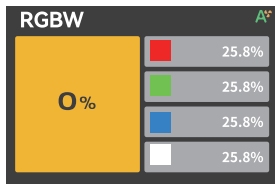

GEL Mode

Press the MODE button to enter mode selection, turn and press the select dial to choose GEL mode. Turn and press the select dial to adjust brightness, GEL type, GEL group type, color, CCT, HUE and SAT values, turn clockwise to increase while turn anticlockwise to decrease.

Brightness: 0% ~ 100%

GEL type: ROSCO/LEE

GEL Group Type (ROSCO)
Color correction/CalColor/Storaro Selection/Cinelux

GEL Group Type (LEE)
Color correction/Color Filters/600 Series/Cosmetic Filters/700 Series

CCT: 3200K or 5600K

HUE: -10 ~ 10

SAT: -20% ~ 20%

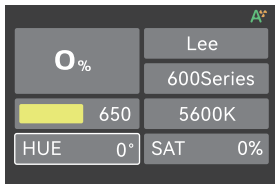

FX Mode

Press the MODE button to enter mode selection, turn and press the select dial to choose FX mode. Turn and press the select dial to choose among flash, lightning, cloudy, broken bulb, TV, candle, fire, firework, explosion, welding, police car, SOS, RGB cycle and party. Then turn and press the select dial clockwise to increase while turn anticlockwise to decrease their respective parameters.

1. Flash

This effect simulates a camera flash or flash bulb and is often used to create a vivid, lively atmosphere.

Brightness: 0% -100% (in 1% increment)

Switch: Turn on/off the effect

Trigger: A (Auto) / M (Manual)

Color: CCT/HSI

CCT/HUE: 1800K-10000K/0-360°

Speed: 1-100

Mode: Camera Flash/Flash Bulb

2. Lightning

This effect simulates the natural thunder and lightning and is often used to create a tense, terrifying or mysterious atmosphere.

Brightness: 0% -100% (in 1% increment)

Switch: Turn on/off the effect

Trigger: A (Auto) / M (Manual)

CCT: 1800K-10000K

Times: Random/1-10

Frequency: Random /2-20

3. Cloudy

This effect simulates the effect of cloud occlusion and is often used to create a gloomy, oppressive or sad atmosphere.

Brightness: 0% -100% (in 1% increment)

Switch: Turn on/off the effect

Ratio: 30% -90%

Speed: Random/1-100

4. Broken Bulb

This effect simulates the effect of a broken bulb and is often used to create a dim atmosphere.

Brightness: 0% -100% (in 1% increment)

Switch: Turn on/off the effect

Color: CCT/HSI

CCT/HUE: 1800K-10000K/0-360°

Speed: 1-100

5. TV

This effect simulates the effect of light from a television or screen and is often used to create a cold, mechanical or digital atmosphere.

Brightness: 0% -100% (in 1% increment)

Switch: Turn on/off the effect

Color: CCT/HSI

Speed: 1-100

6. Candle

This effect simulates the effect of light from a candle and is often used to create a soft, warm, shimmering atmosphere.

Brightness: 0% -100% (in 1% increment)

Switch: Turn on/off the effect

Speed: 1-100

7. Fire

This effect simulates the effect of light from flame and is often used to create a bright, warm, shimmering atmosphere.

Brightness: 0% -100% (in 1% increment)

Switch: Turn on/off the effect

Speed: 1-100

8. Firework

This effect simulates the effect of light from fireworks and is often used to create a gorgeous, colorful, romantic atmosphere.

Brightness: 0% -100% (in 1% increment)

Switch: Turn on/off the effect

Embers: 1-100

Speed: 1-100

9. Explosion

This effect simulates the effect of light from explosion and is often used to create a bright, fierce, shimmering atmosphere.

Brightness: 0% -100% (in 1% increment)

Switch: Turn on/off the effect

Trigger: A (Auto) / M (Manual)

Color: CCT/HSI

CCT/HUE: 1800K-10000K/0-360°

Embers: 1-100

Speed: 1-100

10. Welding

This effect simulates the effect of light from welding and is often used to create a hot, mechanical atmosphere.

Brightness: 0% -100% (in 1% increment)

Switch: Turn on/off the effect

Color: CCT/HSI

CCT/HUE: 1800K-10000K/0-360°

Speed: 1-100

11. Police Car

This effect simulates the effect of light from police car and is often used to create a tension, chasing atmosphere.

Brightness: 0% -100% (in 1% increment)

Switch: Turn on/off the effect

Color: Red+Blue/Red/Blue/Blue+White/Blue+Yellow/Yellow/Red+White+Blue/ Red +Yellow +Blue

Mode: 1-5

12. SOS SOS

This effect simulates the flashing effect of an SOS signal and is often used to create a dangerous, distress or emergency atmosphere.

Brightness: 0% -100% (in 1% increment)

Switch: Turn on/off the effect

Color: CCT/HSI

CCT/HUE: 1800K-10000K/0-360°

13. RGB Cycle

This effect simulates the effect cycle and change of colorful lights and is often used to create a fantasy, sci-fi atmosphere.

Brightness: 0% -100% (in 1% increment)

Switch: Turn on/off the effect

SAT: 0%-100%

Speed: 1-100

14. Party

This effect simulates the effect of colorful lights, flashes and laser, and is often used to create a carnival, fun, high energetic atmosphere.

Brightness: 0% -100% (in 1% increment)

Switch: Turn on/off the effect

SAT: 0%-100%

Speed: 1-100

Note: Please turn the select dial to adjust the parameters, then press and turn it to the next parameter. Select manual, the effect can be triggered once by pressing the select dial once. After a certain effect is set, press MODE button can return to the 14 effects interface.

MENU Settings

Press the MENU button to enter menu interface, turn and press the select dial to enter the following setting options.

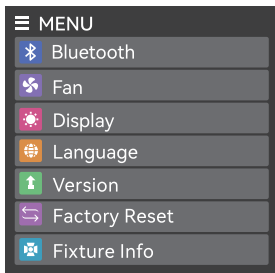

1. Bluetooth

Turn and press the select dial to enter Bluetooth, turn it to select between Bluetooth switch (on/off) and reset, while the Bluetooth MAC code is on the right corner for convenient check, then press MENU button to return to the menu interface.

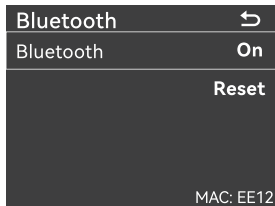

Quick Bluetooth Reset: Press and hold the Bluetooth button to quickly reset the Bluetooth, the “Resetting” progress bar is full means Bluetooth is resetting.

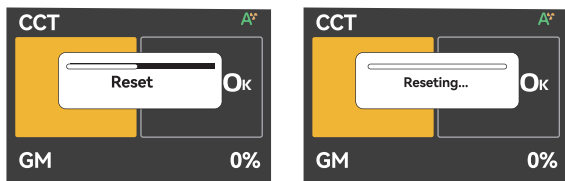

“GODOX Light” App Download

Scan the QR code to download the "Godox Light" smartphone app (can be used in Android and Apple).

Note:

1. The app can be used directly on the firstly installed device (smartphone or iPad). When change to other mobile device (smartphone or iPad), the light shall be reset before the normal connection of app.
2. The app needs to be version V3.0 or above.



2. Fan

Turn and press the select dial to enter fan, turn it to select among off, auto, medium and high, then press MENU button to return to the menu interface.

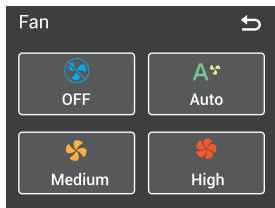

3. Display

Turn and press the select dial to enter display, turn it to adjust screen brightness from 10% to 100% (turn clockwise to increase while turn anticlockwise to decrease), then press MENU button to return to the menu interface.

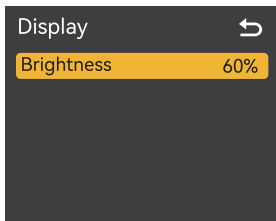

4. Language

Turn and press the select dial to enter language, turn it to select between simplified Chinese and English, then press MENU button to return to the menu interface.



5. Version

Turn and press the select dial to enter version, on which you can check upgrade steps and firmware version on the right corner, then press MENU button to return to the menu interface.



6. Factory Reset

Turn and press the select dial to enter factory reset, turn it to select yes or no. The device will automatically reset and reboot if you choose yes, then simplified Chinese and English options show on the display for your choice, after which the brightness will turn to 100% and go to CCT mode automatically.

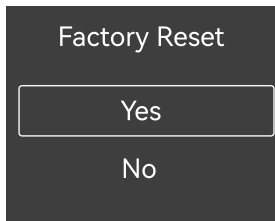

7. Fixture Info

Turn and press the select dial to enter fixture info, on which you can check model, firmware version and light head temperature, then press MENU button to return to the menu interface.

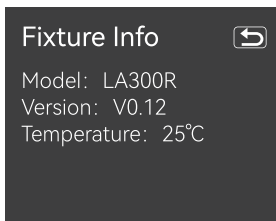
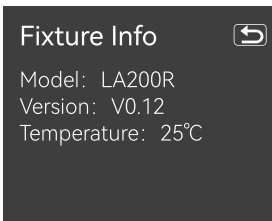
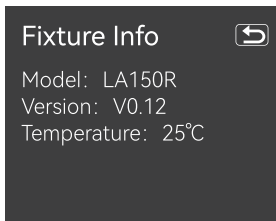

NFC Addition

Use the NFC function of smartphone and NFC chip of the light fixture to connect them, then add the light fixture to **【Godox Light】** app.

1. Preconditions: light fixture supports NFC addition, **【Godox Light】** app is V3.2.4 or above, Bluetooth and NFC functions of smartphone are turned on.
2. Operation Instructions: subject to the fulfillment of preconditions, turn on the **【Godox Light】** app and enter the corresponding scene, click **【+】** to select **【NFC Addition】** function, bring the NFC sensing area of smartphone near the sensing area of light fixture to scan to add in **【NFC Addition】** interface, bulk addition is also supported.

Note: Android systems can complete the addition by directly closing the sensing area, while iOS system need to click the  icon on the right top and wait for the pop-up window then add.

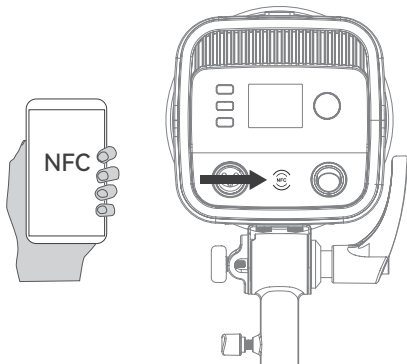

Maintenance

- This product, except consumables, is supported with a one-year warranty.
- Unauthorized service will void the warranty.
- Maintenance of the light must be performed by our authorized maintenance department which can provide original accessories.
- If the product had failures or was wetted, do not use it until it is repaired by professionals.
- Shut down the device immediately should abnormal operation be detected.
- Changes made to the specifications or designs may not be reflected in this manual.

Illuminance Data

LA150R

CCT	Condition	Unit	1m	3m	5m
1800K	Bare Light	lux	≈2438	≈272	≈93
		fc	≈225	≈25	≈9
2800K		lux	≈5270	≈613	≈229
		fc	≈489	≈57	≈21
3200K		lux	≈5490	≈637	≈239
		fc	≈510	≈59	≈22
4300K		lux	≈5370	≈619	≈233
		fc	≈498	≈58	≈22
5600K		lux	≈5060	≈582	≈217
		fc	≈471	≈54	≈20
6500K		lux	≈4960	≈571	≈213
		fc	≈461	≈53	≈20
8500K		lux	≈4750	≈546	≈204
		fc	≈441	≈51	≈19
10000K		lux	≈4640	≈534	≈200
		fc	≈431	≈50	≈19
Red	lux	≈1190	≈124	≈46	
	fc	≈110	≈12	≈4	
Green	lux	≈1849	≈209	≈79	
	fc	≈172	≈19	≈7	
Blue	lux	≈589	≈68	≈26	
	fc	≈55	≈6	≈2	

CCT	Condition	Unit	1m	3m	5m
1800K	With Reflector BR30	lux	≈27968	≈2502	≈883
		fc	≈2602	≈233	≈82
2800K		lux	≈54400	≈4960	≈1720
		fc	≈5050	≈461	≈160
3200K		lux	≈57100	≈5070	≈1770
		fc	≈5300	≈471	≈164
4300K		lux	≈55500	≈4940	≈1720
		fc	≈5150	≈459	≈160
5600K		lux	≈52900	≈4660	≈1620
		fc	≈4910	≈433	≈151
6500K		lux	≈51400	≈4560	≈1580
		fc	≈4780	≈424	≈147
8500K		lux	≈49300	≈4370	≈1510
		fc	≈4580	≈406	≈141
10000K		lux	≈48200	≈4290	≈1480
		fc	≈4480	≈398	≈138
Red	lux	≈12880	≈1168	≈411	
	fc	≈1196	≈109	≈38	
Green	lux	≈20332	≈1840	≈636	
	fc	≈1895	≈171	≈59	
Blue	lux	≈6010	≈554	≈191	
	fc	≈559	≈52	≈18	

LA200R

CCT	Condition	Unit	1m	3m	5m
1800K	Bare Light	lux	≈2646	≈298	≈110
		fc	≈246	≈28	≈10
2800K		lux	≈6430	≈731	≈274
		fc	≈603	≈68	≈25
3200K		lux	≈6620	≈758	≈282
		fc	≈615	≈71	≈26
4300K		lux	≈6520	≈748	≈279
		fc	≈606	≈70	≈26
5600K		lux	≈6210	≈711	≈265
		fc	≈577	≈66	≈25
6500K		lux	≈6060	≈697	≈259
		fc	≈563	≈65	≈24
8500K		lux	≈5850	≈673	≈250
		fc	≈543	≈63	≈23
10000K	lux	≈5720	≈661	≈246	
	fc	≈532	≈61	≈23	
Red	lux	≈1284	≈143	≈54	
	fc	≈200	≈13	≈5	
Green	lux	≈1999	≈227	≈86	
	fc	≈186	≈21	≈8	
Blue	lux	≈623	≈70	≈26	
	fc	≈58	≈6	≈2	

CCT	Condition	Unit	1m	3m	5m
1800K	With Reflector BR30	lux	≈31066	≈2822	≈980
		fc	≈2891	≈263	≈91
2800K		lux	≈65900	≈5930	≈2050
		fc	≈6120	≈552	≈190
3200K		lux	≈68000	≈6070	≈2110
		fc	≈6320	≈564	≈196
4300K		lux	≈67300	≈5970	≈2070
		fc	≈6250	≈554	≈192
5600K		lux	≈64000	≈5850	≈1980
		fc	≈5950	≈544	≈184
6500K		lux	≈62800	≈5560	≈1930
		fc	≈5830	≈517	≈180
8500K		lux	≈60600	≈5380	≈1880
		fc	≈5630	≈500	≈175
10000K		lux	≈59400	≈5280	≈1830
		fc	≈5520	≈93	≈170
Red		lux	≈14014	≈1303	≈452
		fc	≈1303	≈122	≈42
Green	lux	≈21854	≈1999	≈691	
	fc	≈2029	≈186	≈64	
Blue	lux	≈6290	≈561	≈195	
	fc	≈585	≈52	≈18	

LA300R

CCT	Condition	Unit	1m	3m	5m
1800K	Bare Light	lux	≈3050	≈328	≈123
		fc	≈283	≈31	≈11
2800K		lux	≈9930	≈1120	≈415
		fc	≈922	≈104	≈39
3200K		lux	≈10100	≈1140	≈425
		fc	≈935	≈106	≈40
4300K		lux	≈9750	≈1110	≈414
		fc	≈905	≈103	≈39
5600K		lux	≈9210	≈1030	≈392
		fc	≈856	≈96	≈36
6500K		lux	≈8430	≈964	≈358
		fc	≈783	≈90	≈33
8500K		lux	≈7510	≈859	≈319
		fc	≈698	≈80	≈40
10000K		lux	≈7200	≈822	≈396
		fc	≈669	≈76	≈37
Red		lux	≈1560	≈176	≈66
		fc	≈145	≈16	≈6
Green	lux	≈2100	≈238	≈89	
	fc	≈195	≈22	≈8	
Blue	lux	≈766	≈86	≈32	
	fc	≈71	≈8	≈3	

CCT	Condition	Unit	1m	3m	5m
1800K	With Reflector BR30	lux	≈36600	≈3340	≈1160
		fc	≈3400	≈310	≈107
2800K		lux	≈100000	≈8990	≈3100
		fc	≈9310	≈835	≈288
3200K		lux	≈102000	≈9170	≈3160
		fc	≈9450	≈852	≈294
4300K		lux	≈99800	≈8930	≈3080
		fc	≈9270	≈830	≈286
5600K		lux	≈94700	≈8450	≈2910
		fc	≈8800	≈785	≈271
6500K		lux	≈86300	≈7640	≈2630
		fc	≈8020	≈710	≈245
8500K		lux	≈77100	≈6850	≈2370
		fc	≈7160	≈636	≈220
10000K		lux	≈73900	≈6580	≈2280
		fc	≈6870	≈611	≈211
Red		lux	≈17400	≈1590	≈548
		fc	≈1610	≈147	≈51
Green	lux	≈22800	≈2070	≈716	
	fc	≈2120	≈193	≈67	
Blue	lux	≈7860	≈699	≈238	
	fc	≈730	≈65	≈22	

The above data are average values instead of absolute values, and the above tests are conducted on the condition of 100% brightness.

Technical Data

Model	LA150R	LA200R	LA300R
Input Power	165W	220W	330W
Power Supply	100V-240V ~ 50/60Hz		
CCT	1800K-10000K		
GM Adjust	-100% ~ 100%		
Brightness Range	0%-100%		
CRI	Average \geq 95		
TLCI	Average \geq 94		
Bluetooth Control Distance	Max. 30m		
Working Environment Temperature	-20°C ~ 40°C		
Dimension (without reflector)	\approx 9.09" \times 6.14 " \times 9.37		
Net Weight (without reflector)	\approx 2.5kg		

FCC Statement

This device complies with part 15 of the FCC Rules. Operation is subject to the following two conditions:

- (1) This device may not cause harmful interference, and
- (2) this device must accept any interference received, including interference that may cause undesired operation.

Any Changes or modifications not expressly approved by the party responsible for compliance could void the user's authority to operate the equipment.

Note: This equipment has been tested and found to comply with the limits for a Class B digital device, pursuant to part 15 of the FCC Rules. These limits are designed to provide reasonable protection against harmful interference in a residential installation. This equipment generates uses and can radiate radio frequency energy and, if not installed and used in accordance with the instructions, may cause harmful interference to radio communications. However, there is no guarantee that interference will not occur in a particular installation. If this equipment does cause harmful interference to radio or television reception, which can be determined by turning the equipment off and on, the user is encouraged to try to correct the interference by one or more of the following measures:

- Reorient or relocate the receiving antenna.
- Increase the separation between the equipment and receiver.
- Connect the equipment into an outlet on a circuit different from that to which the receiver is connected.
- Consult the dealer or an experienced radio/TV technician for help.

The device has been evaluated to meet general RF exposure requirement.

The device can be used in portable exposure condition without restriction.

Warning

Operating frequency: 2402MHz – 2480MHz (BT)

Maximum EIRP Power: 5dBm

Declaration of Conformity

GODOX Photo Equipment Co.,Ltd. hereby declares that this equipment are in compliance with the essential requirements and other relevant provisions of Directive 2014/53/EU. In accordance with Article 10(2) and Article 10(10), this product is allowed to be used in all EU member states.For more information of DoC, Please click this web link:

<https://www.godox.com/eu-declaration-of-conformity/>

The device complies with RF specifications when the device used at 0mm from your body.

产品保修

尊敬的用户, 本保修卡是申请保修服务的重要凭证, 请您配合销售商填写并妥善保管, 谢谢!

产品信息	型号	产品条码
用户信息	姓名	联系电话
	通信地址	
销售商信息	名称	
	联系电话	
	通信地址	
	销售日期	
备注		

注: 此表应由销售商盖章确认。

产品信息

本文件适用于相关《产品保修信息》(见后面说明)所列产品,其他非属此范围的产品或部件(如促销品、赠品及其他出厂后附加的部件等)不在此保修承诺内。

保修期

产品及部件的相应保修期按相关的《产品保修信息》执行。保修期自产品首次购买日起算, 购买日以购买产品时保修卡登记日期为准。

如何获得保修服务

您可直接与产品销售商或授权服务机构联系, 也可拨打神牛产品售后服务电话, 与我们联系, 由我们的服务人员为您安排服务。申请保修时, 您应提供有效的保修卡作为保修凭证, 方可获得保修。如您不能提供有效的保修卡, 则在我们确认产品或部件属于保修范围的情况下, 也可以为您提供保修, 但这不作为我们的义务。

不适用保修情况

如产品存在下列情况, 本文件项下的保证和服务将不适用: ①产品或部件超过相应保修期; ②错误或不当使用、维护或保管导致的故障或损坏, 如: 不当搬运; 非按产品合理预期用途使用; 不当插拔外接设备; 跌落或外力挤压; 接触或暴露于不适当温度、溶剂、酸碱、水浸或潮湿环境; ③由非神牛授权机构或人员安装、修理、更改、添加或拆卸造成的故障或损坏; ④产品或部件原有识别信息被修改或删除; ⑤无有效保修卡; ⑥使用非合法授权、非标准或非公开发行的软件造成的故障或损坏; ⑦因不可抗力或意外事件造成的故障或损坏; ⑧其他非因产品本身质量问题导致的故障或损坏。遇上述情况, 您应向相关责任方寻求解决, 神牛对此不承担任何责任。因非在保修期或保修范围内的部件、附件或软件导致产品不能正常使用的, 不是保修范围内的故障。产品使用过程中正常的脱色, 磨损和消耗, 不是保修范围内的故障。

产品保修和服务支持信息

产品的保修期和服务类型按以下《产品保修信息》执行:

产品类别	选件名称	保修期(月)	保修服务类型
部件	电路板	12	客户送修
	电池	3	客户送修
	充电器等带电性能的部件。	12	客户送修
其他	如外壳、保护罩、锁紧装置、包装等。	无	无保修

神牛产品售后服务电话 0755-29609320-8062

Warranty

Dear customers, as this warranty card is an important certificate to apply for our maintenance service, please fill in the following form in coordination with the seller and safe-keep it. Thank you!

Product Information	Model	Product Code Number
Customer Information	Name	Contact Number
	Address	
Seller Information	Name	
	Contact Number	
	Address	
	Date of Sale	
Note		

Note: This form shall be sealed by the seller.

Applicable Products

Applicable ProductsThe document applies to the products listed on the Product Maintenance Information (see below for further information). Other products or accessories (e.g. promotional items,giveaways and additional accessories attached,etc.) are not included in this warranty scope.

Warranty Period

The warranty period of products and accessories isimplemented according to the relevant Product Maintenance Information. The warranty period is calculated from the day(purchase date) when the product is bought for the first time,And the purchase date is considered as the date registered onthe warranty card when buying the product.

How to Get the Maintenance Service

If maintenance service is needed, you can directly contact the product distributor or authorized service institutions. You can also contact the Godox after-sale service call and we will offer you service. When applying for maintenance service, you should provide valid warranty card. If you cannot provide valid warranty card, we may offer you maintenance service once confirmed that the product or accessory is involved in the maintenance scope, but that shall not be considered as our obligation.

Inapplicable Cases

The guarantee and service offered by this document are not applicable in the following cases: ① **The product or accessory has expired its warranty period;** ② **Breakage or damage caused by inappropriate usage, maintenance or preservation, such as improper packing, improper usage, improper plugging in/out external equipment, falling off or squeezing by external force, contacting or exposing to the improper temperature, solvent, acid, base, flooding and damp environments, etc;** ③ **Breakage or damage caused by non-authorized institution or staff in the process of installation, maintenance, alternation, addition and detachment;** ④ **The original identifying information of product or accessory is modified, alternated, or removed;** ⑤ **No valid warranty card;** ⑥ **Breakage or damage caused by using illegally authorized, nonstandard or non-public released software;** ⑦ **Breakage or damage caused by force majeure or accident;** ⑧ **Breakage or damage that could not be attributed to the product itself.** Once met these situations above, you should seek solutions from the related responsible parties and Godox assumes no responsibility. The damage caused by parts, accessories and software that beyond the warranty period or scope is not included in our maintenance scope. The normal discoloration, abrasion and consumption are not the breakage within the maintenance scope.

Maintenance and Service Support Information

The warranty period and service types of products are implemented according to the following Product Maintenance Information:

Product Type	Name	Maintenance Period(month)	Warranty Service Type
Parts	Circuit board	12	Customer sends the product to designated site
	Battery	3	Customer sends the product to designated site
	Electrical parts e.g.battery charger, etc.	3	Customer sends the product to designated site
Other Items	Lamp body, lamp cover, locking device, package, etc.	No	Without warranty

合格证
QC PASS



Wechat
Official Account
神牛微信公众号

深圳市神牛摄影器材有限公司

地址：深圳市宝安区福海街道塘尾社区耀川工业园厂房2栋
电话：0755-29609320 (8062) 传真：0755-25723423 邮箱：godox@godox.com

GODOX Photo Equipment Co., Ltd.

Add.: Building 2, Yaochuan Industrial Zone, Tangwei Community, Fuhai Street, Bao'an District, Shenzhen
518103, China Tel: +86-755-29609320(8062) Fax: +86-755-25723423 E-mail: godox@godox.com

www.godox.com

Made in China | 705-LA200R-00

