

Godox

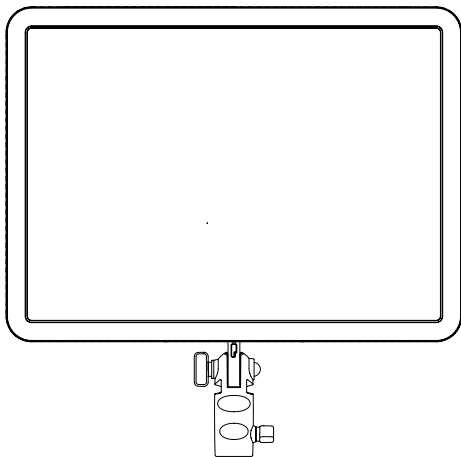

P260C Pro

神牛双色温直播板灯
Godox Bi-Color Light Panel

使用手册
Instruction Manual

重要的安全说明及注意事项

首先作为最基本原则：本产品为专业灯光布景设备，应由专业灯光师使用或在专业人士指导下使用。使用时必须始终遵循基本的安全预防措施，具体安全预防措施如下：

1. 使用前必须阅读并理解产品说明书。
2. 专业灯具，禁止儿童使用。当儿童靠近时，家长或监护人必须密切监督，以免儿童因碰撞灯具或私用灯具造成人身伤害。
3. 本灯具并非普通照明灯具，不可用于普通照明，任何有过眼部损伤或眼部敏感的人群均应避免使用本灯具。
4. 灯具点亮时，必须小心使用，禁止接触高温部件，如 LED 灯珠，以免造成灼伤。
5. 灯具点亮时，任何情况下均禁止直视灯珠。应该在专业灯光师指导下使用强光，任何情况下避免长时间处于强光环境，如引起眼睛不适，请及时关闭灯具，暂停使用，请及时就医。
6. 倘灯珠损坏或因热变形，应停止使用，并及时联系制造商、服务代理商或合格的维修人员更换灯珠，以免发生意外。
7. 本产品仅适用于 $-10^{\circ}\text{C} \sim 40^{\circ}\text{C}$ 工作环境温度及正常湿度环境下使用。
8. 请勿使用损坏的设备或设备配件，待专业维修人员检查维修，确认设备正常方可使用。
9. 在使用过程中，如果本产品由于跌落、受到挤压或遭受强烈冲击而造成外壳破裂的，请勿继续使用，以免因接触到内部电子元件而受到电击伤害。
10. 如需要延长线，请使用额定电流 \geq 该设备额定电流的延长线。如延长线额定电流小于该设备，可能导致过热。
11. 部分产品电源线较长，请合理放置电源线，使其处于安全位置。避免电源线接触过热物体表面、避免放置不当导致拉扯损坏或绊倒现场人员。请使用本厂原装电源线，如使用非本厂电源线导致产品损坏，一概不在本厂维修范围内。
12. 在清洁和维修之前，请务必从电源插座上拔下该设备插头。不使用时，禁止拉扯电源线以将设备插头从电源插座中拔出。正常断电，应是用手抓住该设备插头两端，将插头从电源插座中拔出。此设备需连接到接地插座中。
13. 本设备没有防水性能，请让设备保持干燥，请勿将本设备浸入水中或其他液体中。设备需安装在干燥且通风处，避免在雨天、潮湿、多尘或过热环境下使用。请勿将任何物体置于灯具上或使液体流入灯具内部，以免发生意外。
14. 请勿私自拆卸产品，如产品出现故障，须由本公司或授权的维修人员进行检查维修。
15. 存放本设备之前，请确保设备已完全冷却。存放时，将电源线从设备上拔出。设备应放置于设备便携包内或通风干燥处。
16. 请勿将设备放置在酒精、汽油等易燃易爆挥发的溶剂附近。
17. 本厂不推荐的产品附件，请勿使用，以免导致火灾、触电或人身伤害。
18. 清洁本设备时，请勿用湿布擦拭，请用干布、软布擦拭设备污垢。
19. 设备使用前，请注意将保护罩取下。
20. 本产品已通过 ROHS, CE 和 FCC 认证，请参考相关国家标准使用和操作。
21. 安全说明依据本厂严格测试制定，设备设计和规格如有变更，恕不另行通知。客户可以

上神牛官网查看最新的电子版说明,了解产品最新资讯。





22. 部分产品内置锂电池,此类产品请使用专用的充电器进行充电,并且按正确的操作说明,在规定的电压、温度范围内使用。
23. 部分产品使用电池供电,此类产品请勿使用说明书中未指定的任何电池、电源或附件。请将电池和其他附件置于儿童及婴幼儿无法触及之处。如果儿童或婴幼儿吞下电池或附件,请立即就医。如果电池漏液、变色、变形、冒烟或发出异味,请立即将其取出。在取出过程中请小心,以免烫伤。如果继续使用,可能会引起火灾、触电或皮肤烫伤。请勿使用任何变形或改造过的电池。请勿拆卸或改造本产品或电池。请勿加热电池或焊接电池。请勿让电池与火或水接触。请勿让电池受到强烈的外力撞击。请勿将电池的正负端错误插入,或将新旧电池或不同类型的电池混合使用。
24. 一年保修期,消耗品电池、适配器、电源线等配件不在此保修范围内。
25. 经发现,擅自检修设备,将取消一年保修期,维修需要收取相关费用。
26. 对于不规范操作引起的机器故障不在保修范围内。

前言

感谢您购买神牛产品。

P260C Pro 神牛双色温直播板灯以机身轻薄,色温可调(2800K-6500K),三种供电方式,侧发光并配备柔光板的设计使得光源面高亮却不刺眼,更好地满足于视频直播使用,也为婚庆拍摄,采访布光及静物摄像时提供良好照明。

警告

-  请勿私自拆卸产品,如产品出现故障须由本公司或授权的维修人员进行检查维修。
-  请保持干燥,请勿用湿手接触产品,亦不可将产品浸入水中或暴露于雨中。
-  请勿让儿童接触本产品。
-  请勿在易燃易爆环境中使用。在这些场合下,请注意相关警告标识。
-  若发生任何故障,请立即关闭触发器电源。

部件名称

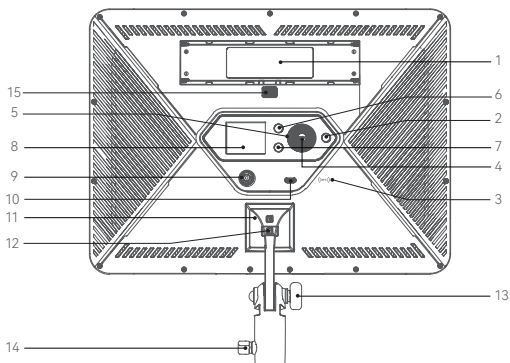

- | | |
|-------------|-------------|
| 1. 电池槽 | 9. DC 电源插孔 |
| 2. 开关按键 | 10. USB-C 口 |
| 3. NFC 感应区域 | 11. 手柄安装槽 |
| 4. SET 按键 | 12. 拆卸手柄按钮 |
| 5. 调节拨盘 | 13. 方向锁紧旋钮 |
| 6. MENU 按键 | 14. 灯架锁紧旋钮 |
| 7. MODE 按键 | 15. 电池装卸按钮 |
| 8. 屏幕 | |

物料清单



灯体 ×1



适配器 ×1



适配器充电线 ×1



手柄 ×1



说明书 ×1

电源管理

供电方式一：锂电池供电

您可另购两节 NP-F 锂电池，分别装入灯具的电池槽中。

注：使用电池供电时，显示屏会显示当前剩余电量。当电量符号闪烁时，表示电池电量极低。为了防止因低电量导致灯具强行熄灭，请及时对电池充电后再使用。

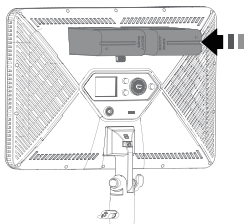

供电方式二：直流电源供电

您可使用标配的适配器（输入 100-240V），接通电源后自动亮灯，灯具自带记忆功能，关闭电源再次启动时将保留上一次设置的亮度值。

注：此供电方式无法给 NP-F 电池充电

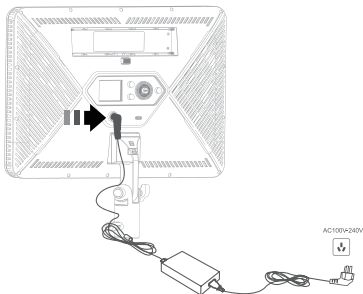

供电方式三：USB-C 口供电

您可另购数据线 with 充电头，接入 USB-C 口即可供电。接通电源后自动亮灯，灯具自带记忆功能，关闭电源再次启动时将保留上一次设置的亮度值。

注：需使用快速充电器，充电器功率小于 10W 显示适配器不适用，10 ~ 30W 最大 30% 亮度，31 ~ 50W 最大 80% 亮度，51W 及以上最大 100% 亮度。

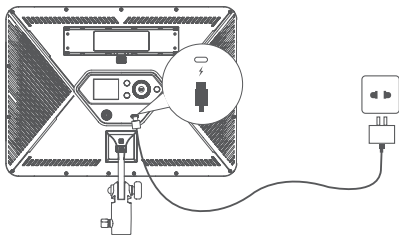

安装电池

- 请先关闭电源（如正在使用 DC 口或 USB-C 口供电）
- 按住电池装卸按钮，将电池带插孔端对准电池槽的正负极触点，推进并卡紧。
- 打开电源开关即可
- 使用完毕后，请关闭电源开关。

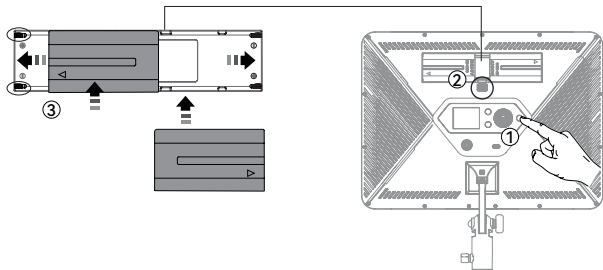

使用方式

1. 手持使用 (如图)

- 按住拆卸手柄按钮, 将标配手柄安装到手柄安装槽。

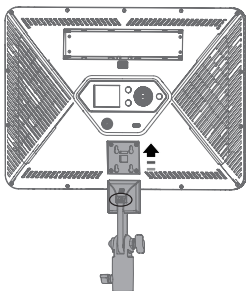

2. 灯架使用 (如图)

- 逆时针旋松灯架锁紧旋钮, 将板灯固定在灯架上。
- 顺时针旋紧灯架锁紧旋钮, 即安装完毕。

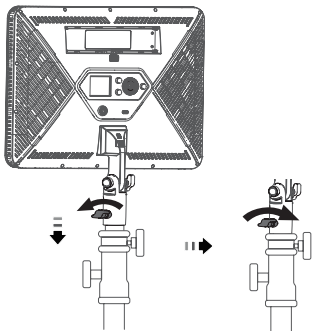

注: 灯架需另购。

操作说明

1. 开机 / 关机

长按开关按钮进行开关机操作, 显示屏亮起即开机, 熄灭即关机完毕。

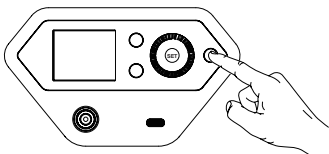

2. 亮度设置

旋转拨盘可设置亮度, 设置范围: 0%-100%, 设置完毕短按 SET 按键。

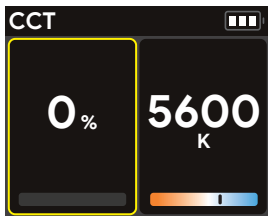

3. 色温设置

旋转拨盘可设置色温, 设置范围: 2800K-6500K, 设置完毕短按 SET 按键。

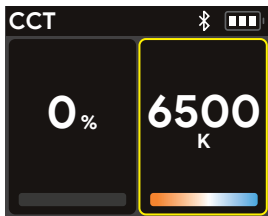

4. 蓝牙设置

短按 MENU 按键选中蓝牙，短按 SET 按键进入蓝牙设置，短按 SET 按键并旋转拨盘可选开启或关闭，设置完毕短按 SET 按键后旋转拨盘跳入下一栏的复位；如需复位请短按 SET 按键并旋转拨盘，屏幕可见进度条，约三秒钟后进度条拉满即复位成功，蓝牙 MAC 码位于界面右下角方便查找匹配。



"Godox Light"app

扫描下面二维码即可下载“Godox Light”手机 APP (安卓和苹果系统都可以使用)。



注：首个移动设备（手机或平板电脑）可直接使用 APP 操控灯体。更换其他移动设备时，灯体需进行蓝牙重置方可正常使用 APP，APP 需升级至 V3.0 以上版本。

5. 语言设置

短按 MENU 按键后旋转拨盘选中语言，短按 SET 按键进入语言设置，旋转拨盘可选 English 或简体中文，设置完毕短按 SET 按键。



6. 屏幕设置

短按 MENU 按键后旋转拨盘选中屏幕设置，短按 SET 按键进入屏幕设置，短按 SET 按键并旋转拨盘可设置屏幕亮度，设置范围：10%-100%。



7. 恢复出厂设置

短按 MENU 按键后旋转拨盘选中恢复出厂设置，短按 SET 按键进入恢复出厂设置，旋转拨盘可选确认或取消；短按 SET 按键确认重置，灯体亮度值自动变为 100% 且来到亮度 / 色温设置界面。



8. 灯具信息

短按 MENU 按键后旋转拨盘选中灯具信息，短按 SET 按键进入灯具信息界面，可查看当前机器的型号与固件版本。

关于本机

型号：P260CPro
固件版本：V0.2

9. FX 光效设置

短按 MODE 按键进入模式选择，可选 CCT 模式或 FX 模式，旋转拨盘选中 FX 并短按 SET 按键进入 FX 光效设置，共有 11 类光效，选中并短按 SET 按键进入某一类光效进行设置。

闪光灯



亮度：0% -100% (以 1% 为增量)

开关：开启 / 关闭

触发：A 自动 / M 手动

色温：2800K-6500K

速度：1-100

模式：闪光灯 / 镁光灯

1. 闪光灯

此光效模拟闪光灯闪光或传统镁光灯闪光，常用于营造一种生动、活泼的氛围。

2. 雷闪电

此光效模拟雷电的闪电，常用于营造一种紧张、恐怖或神秘的氛围。

亮度：0% -100% (以 1% 为增量)

开关：开启 / 关闭

触发：A 自动 / M 手动

频率：随机 / 2-20

色温：2800K-6500K

闪烁次数：随机 / 1-10

3. 多云

此光效模拟云层遮挡效果，常用于营造一种阴沉、压抑或悲伤氛围。

亮度: 0% -100% (以1%为增量)

开关: 开启 / 关闭

亮暗比例: 30%-90%

速度: 随机 / 1-100

4. 坏灯泡

此光效模拟一盏损坏的灯泡闪光，常用于营造昏黄的环境氛围。

亮度: 0% -100% (以1%为增量)

开关: 开启 / 关闭

色温: 2800K-6500K

速度: 1-100

5. 电视机

此光效模拟电视机或屏幕的光线效果，常用于营造一种冷淡、机械或数字化的氛围。

亮度: 0% -100% (以1%为增量)

开关: 开启 / 关闭

速度: 1-100

6. 蜡烛

此光效模拟蜡烛的光线效果，常用于营造一种柔和、温暖、闪烁的氛围。

亮度: 0% -100% (以1%为增量)

开关: 开启 / 关闭

速度: 1-100

7. 火

此光效模拟火焰的光线效果，常用于营造一种明亮、热烈、闪烁氛围。

亮度: 0% -100% (以1%为增量)

开关: 开启 / 关闭

速度: 1-100

8. 烟花

此光效模拟烟花的光线效果，常用于营造一种绚丽、多彩、浪漫的氛围。

亮度: 0% -100% (以1%为增量)

开关: 开启 / 关闭

速度: 1-100

余烬: 1-100

9. 爆炸

此光效模拟爆炸的光线效果，常用于营造出一种明亮、猛烈、闪烁氛围。

亮度：0% -100% (以 1%为增量)

开关：开启 / 关闭

触发：A 自动 /M 手动

色温：2800K-6500K

速度：1-100

余烬：1-100

10. 焊接

此光效模拟焊接的光线效果，常用于营造出一种炽热、机械的氛围。

亮度：0% -100% (以 1%为增量)

开关：开启 / 关闭

色温：2800K-6500K

速度：1-100

11. SOS SOS

此光效模拟 SOS 求救信号的闪烁效果，常用于营造危险、求救或紧急情况氛围。

亮度：0% -100% (以 1%为增量)

开关：开启 / 关闭

色温：2800K-6500K

注：根据需求旋转拨盘并短按 SET 按键进行某一项参数设置，设置完毕后短按 SET 按键，旋转拨盘可跳入下一栏参数进行设置；选中 M 手动时，通过短按一次 SET 按键触发一次该光效；某个光效设置完毕后短按 SET 按键回到 11 类光效选择界面。

NFC 加灯

通过手机 NFC 功能与灯具 NFC 芯片相互通信后完成快速添加灯具到【Godox light】App 中。

1. 前置条件：灯具支持 NFC 添加、【Godox light】App 版本 V3.2.4 以上、手机开启蓝牙和 NFC 功能。
2. 使用方法：前置条件成立情况下，打开【Godox light】进入对应场景中，点击【+】选择【NFC 加灯】功能，进入【NFC 添加设备】页面将手机 NFC 感应区靠近灯具感应区即可完成加灯，支持多灯添加。

注意：Android 系统直接靠近感应加灯，iOS 需点击右上角  图标后出现弹窗感应加灯。

照度数据

色温	照度单位	0.5m	1m	2m
2800K	lux	≈ 3550	≈ 969	≈ 251
	fc	≈ 330	≈ 90	≈ 23
3200K	lux	≈ 3710	≈ 985	≈ 255
	fc	≈ 345	≈ 92	≈ 24
4300K	lux	≈ 3830	≈ 1030	≈ 266
	fc	≈ 356	≈ 96	≈ 25
5600K	lux	≈ 4000	≈ 1070	≈ 276
	fc	≈ 372	≈ 100	≈ 26
6500K	lux	≈ 4160	≈ 1110	≈ 286
	fc	≈ 386	≈ 103	≈ 27

规格参数

型号	P260C Pro
色温	2800K-6500K
输入功率	45W
CRI	平均≥ 98
TLCI	平均≥ 98
控制方式	蓝牙控制 / 灯体控制
工作温度	-10°C~ 40°C
尺寸	≈ 328mm*241mm*27mm
净重	≈ 1kg

Safety Instructions and Attentions

First of all, as the most basic principle: This product is a professional lighting set equipment and should be used by professional lighting engineers or under the guidance of professionals. Basic safety attentions must always be followed during use, as follows:

1. Before use, please read and understand these instructions and attentions.
2. Professional lighting is prohibited for children. When children are near, parents or accompanying persons must supervise closely to prevent children from personal injury due to collision with lamps or private use of lamps.
3. This lighting product is not ordinary lighting product and cannot be used for general lighting. Anyone who has suffered eye damage or has sensitive eyes should avoid using this product.
4. When the lamp is on, it must be used with care. Do not touch high-temperature parts, such as LED lamp beads, to avoid burns.
5. When the lamp is on, it is forbidden to look directly at the lamp beads under any circumstances. Strong light should be used under the guidance of professional lighting engineers. Avoid prolonged exposure to strong light under any circumstances. If eye discomfort, please turn off the lamp in time, suspend use, and see a doctor immediately.
6. If the lamp bead is damaged or deformed by heat, stop using this equipment, and contact the manufacturer, service agent or qualified maintenance personnel to replace the lamp bead in time to avoid accidents.
7. This product is only suitable for use in -10°C to 40°C operating environment and normal humidity environment.
8. Do not use damaged equipment or accessories, and wait for professional maintenance personnel to check and repair to confirm being normal before use.
9. During using, if the casing of this product is broken due to being dropped, squeezed or subjected to strong impact, please do not use it, so as to avoid electric shock injury due to contact with internal electronic components.
10. If an extension cord is required, please use an extension cord with a current rating greater than or equal to that of the equipment. If an extension cord is rated less than the equipment, overheating may result.
11. Some products have long power cords, please place the power cords properly and keep them in a safe place. Avoid contacting the power cord with overheating surfaces, avoid improper placement that could cause pulling damage, or trip on-site personnel. Please use the certified power cord from the original manufacturer. If the product is damaged by using a non-certified power cord, it will not be repaired by our factory.
12. Be sure to unplug equipment from the power outlet before cleaning and repairing. When not in use, do not pull the power cord to unplug the equipment. For normal power-off, please hold both ends of the plug of the equipment with your hands and pull the plug

- out of power outlet. This equipment needs to be connected to a grounded outlet.
13. This equipment is not waterproof, please keep it dry and do not immerse it in water or other liquids. The equipment should be installed in a dry and ventilated place, and avoid using it in rainy, humid, dusty or overheated environments. Do not place any objects on the lamp or let liquid flow into the lamp to avoid accidents.
 14. Do not disassemble the product without permission. If the product fails, it must be checked and repaired by authorized maintenance personnel.
 15. Before storing, make sure that the equipment has cooled down completely. For storage, unplug the power cord from the equipment. The equipment should be placed in the carrying case or in a ventilated dry place.
 16. Do not place equipment near flammable and volatile solvents such as alcohol and gasoline.
 17. Do not use accessories that are not recommended by our factory to avoid fire, electric shock or personal injury.
 18. When cleaning, do not wipe it with a damp cloth, please use a dry cloth or a soft cloth to wipe the dirt of the equipment.
 19. Please take off the protective cover before using.
 20. This product complies with ROHS, CE and FCC certification, please refer to the relevant national standards for use and operation.
 21. The safety instructions are formulated according to the strict testing of the factory, and the design and specifications of the equipment are subject to change without prior notice. For latest product information, please check the GODOX website and view latest electronic instruction.
 22. Some products have built-in lithium batteries. Please use specified chargers, and use them within a proper range of the specified voltage and temperature according to the correct operating instructions.
 23. Some products are battery powered. Do not use any batteries, power sources or accessories not specified in the instructions for such products. Keep batteries and other accessories out of the reach of children and infants. In the instance that a child or infant swallows a battery or accessory, immediate emergency medical attention is required. If the battery leaks, becomes discolored, deformed, emits smoke, or emits an abnormal odor, remove it immediately. Be careful during removal to avoid burns. Continued use could result in fire, electric shock, or burns. Do not use any deformed or modified batteries. Do not disassemble or modify this product or battery. Do not heat or solder the battery. Keep the battery away from fire or water. Do not incorrectly insert the positive and negative ends of batteries, or mix old and new batteries or batteries of different types together.
 24. One-year warranty period, accessories such as consumable batteries, adapters, power cords, etc. are not covered by this warranty.

25. If it is found that the equipment is repaired without authorization, the one-year warranty period will be cancelled and relevant fees will be charged for maintenance.
26. Machine failures caused by non-standard operation are not covered by the warranty.

keep these instructions!





Foreword

Thank you for purchasing!

P260C Pro is designed with light and slim body, adjustable CCT from 2800K to 6500K and three ways of power supply. The side lighting design together with diffuser deliver bright but not glaring light, making it excellent for live streaming, wedding shooting, interview lighting and still life photography, etc.

Please read this manual carefully before using to make sure the correct operation and exert the optimum function.

Warning

-  Do not disassemble. Should repairs become necessary, this product must be sent to an authorized maintenance center.
-  These devices are not waterproof. Keep them dry, do not immerse in water or other liquids. Do not use in rainy, humid, dusty in overheated environments.
-  Keep out of reach of children.
-  Do not use in the presence of flammable gas. In certain circumstance, please pay attention to the relevant warnings.
-  Should any malfunctions occur, please cut off the power immediately.

Names of Parts

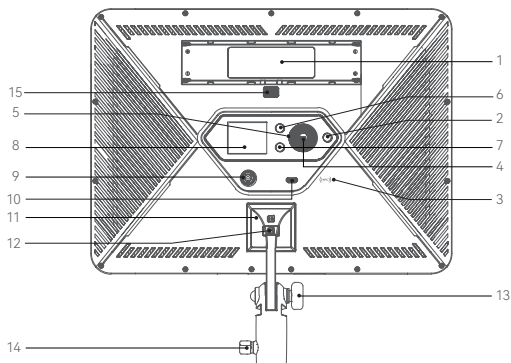

- | | |
|------------------------|---|
| 1. Battery Compartment | 9. DC Power Jack |
| 2. Power Switch Button | 10. USB-C Port |
| 3. NFC Sensing Area | 11. Handle Installing Groove |
| 4. SET Button | 12. Handle Detaching Button |
| 5. Select Dial | 13. Direction Locking Button |
| 6. MENU Button | 14. Light Stand Locking Button |
| 7. MODE Button | 15. Battery Installing and Detaching Button |
| 8. Screen | |

What's Inside

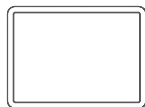

Light Body ×1



Adapter ×1



Adapter Charging
Cord ×1



Handle ×1



Instruction
Manual ×1

Power Management

1. Lithium Battery Power Supply

Put two NP-F model lithium batteries (purchased separately) into the battery compartment separately.

Note: When using lithium battery, the battery level is displayed on the screen. When it blinks, the lithium battery power is low. Please recharge it immediately before usage in order to avoid forceful auto off.

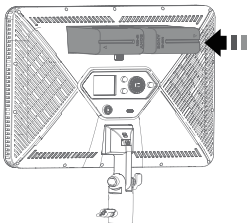

2. DC Power Supply

Use a 100~240V adapter (included) to connect the light with the DC power jack, the light will then be turned on. It will resume to the last brightness once be powered on again for the memory function.

Note: The DC power supply can not charge the NP-F battery.

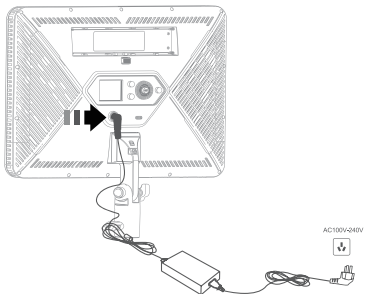

3. USB-C Power Supply

Use a USB-C data cable and adapter (purchased separately) to connect the light with the USB-C port, the light will then be turned on. It will resume to the last brightness once be powered on again for the memory function.

Note: A fast charger is required. A charger with the power of 10W and below is not applicable; charger power is between 10W to 30W, the max brightness should be 30%; charger power is between 31W to 50W, the max brightness should be 80%; charger power is 51W and above, the max brightness should be 100%.

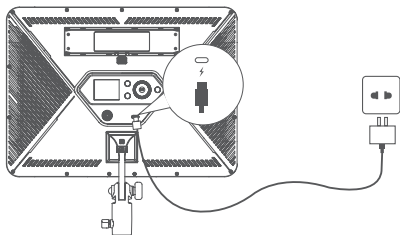

Installing Lithium Battery

- Turn the power switch off first (If the light is powered by DC port or USB-C port).
- Press and hold the battery installing and detaching button, target the socket of the lithium battery towards the "+" "-" contacts of the battery compartment, push the battery in until it locks.
- Power the light on.
- After using the light, please power it off.

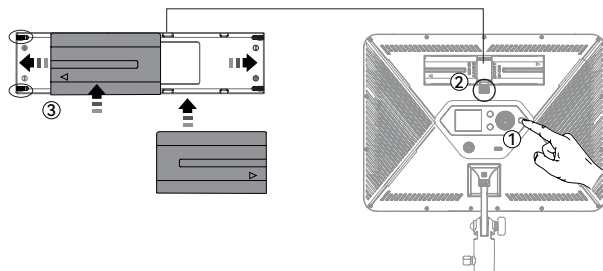

Using Instructions

1. By the Handle

- Press and hold the handle detaching button, then install the handle into the handle installing groove.

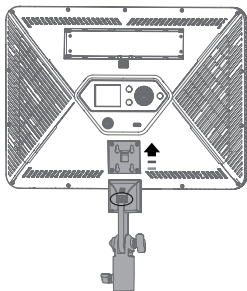

2. On the Light Stand

- Rotate anticlockwise the light stand locking ring to loosen it, mount the light body onto the light stand.
- Rotate clockwise the light stand locking ring to tighten it.

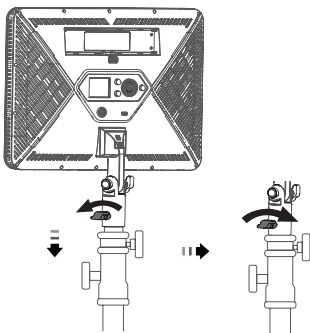

Note: The light stand is sold separately.

Operation Instructions

1. Power Switch

Press and hold power switch button to turn on or off the device, the screen lightened on means power on, the screen off means power off.

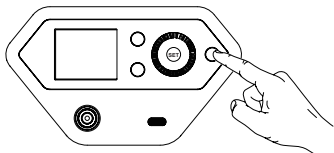

2. Brightness

Turn the select dial to adjust the brightness from 0% to 100%, then press the SET button to confirm.

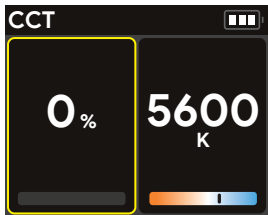

3. CCT

Turn the select dial to adjust color temperature from 2800K to 6500K, then press the SET button to confirm.

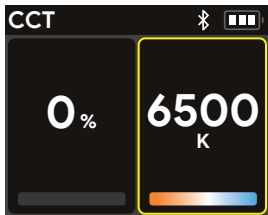

4. Bluetooth

Press the MENU button and turn the select dial to select Bluetooth, press the SET button to enter Bluetooth setting, then turn the select dial to turn on or off the Bluetooth. Turn the select dial to enter Bluetooth reset, then press the MENU button and turn the select dial to reset, the "RESET" progress bar will be full in about 3s. The Bluetooth MAC code is on the right corner.

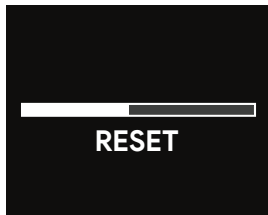
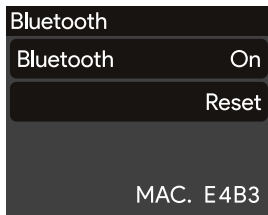

"Godox Light" app

Scan the QR code to download the "Godox Light" smartphone app (can be used in Android and Apple).



Note:

The app can be used directly on the firstly installed device (smartphone or iPad). When change to other mobile device (smartphone or iPad), the light shall be reset before the normal connection of app. The app needs to be version 3.0 or above.

5. Language

Press the MENU button and turn the select dial to select language, press the SET button to enter language setting, then turn the select dial to choose English or simplified Chinese, then press the SET button to confirm.



6. Display

Press the MENU button and turn the select dial to select display, press the SET button to enter display setting, then press the MENU button and turn the select dial to adjust display brightness from 10% to 100%.



7. Factory Reset

Press the MENU button and turn the select dial to select factory reset, press the SET button to enter factory reset setting, then turn the select dial to choose confirm or cancel. If you choose confirm, the brightness will turn to 100% and go to Brightness/CCT interface automatically after resetting.

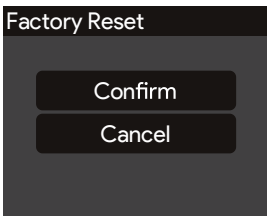

8. Fixture Info

Press the MENU button and turn the select dial to select fixture info, press the SET button to enter fixture info interface, on which you can check model and firmware version.

Fixture Info

Model: P260CPro
Firmware Ver: V0.2

9. FX Modes

Press the MODE button to enter CCT mode or FX mode selection, turn the select dial and press the SET button to enter FX mode, then turn the select dial and press the SET button to choose a desired mode among 11 FX modes and adjust its parameters.

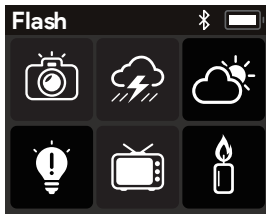

9.1 Flash

This effect simulates a camera flash or flash bulb and is often used to create a vivid, lively atmosphere.

Brightness: 0% -100% (in 1% increment)

Switch: Turn on/off the effect

Trigger: A (Auto) / M (Manual)

CCT: 2800K-6500K

Speed: 1-100

Mode: Camera/Bulb

9.2 Lightning

This effect simulates the natural thunder and lightning and is often used to create a tense, terrifying or mysterious atmosphere.

Brightness: 0% -100% (in 1% increment)

Switch: Turn on/off the effect

Trigger: A (Auto) / M (Manual)

Frequency: Random /2-20

CCT: 2800K-6500K

Times: Random/1-10

9.3 Cloudy

This effect simulates the effect of cloud occlusion and is often used to create a gloomy, oppressive or sad atmosphere.

Brightness: 0% -100% (in 1% increment)

Switch: Turn on/off the effect

Ratio: 30% -90%

Speed: Random/1-100

9.4 Broken Bulb

This effect simulates the effect of a broken bulb and is often used to create a dim atmosphere.

Brightness: 0% -100% (in 1% increment)

Switch: Turn on/off the effect

CCT: 2800K-6500K

Speed: 1-100

9.5 TV

This effect simulates the effect of light from a television or screen and is often used to create a cold, mechanical or digital atmosphere.

Brightness: 0% -100% (in 1% increment)

Switch: Turn on/off the effect

Speed: 1-100

9.6 Candle

This effect simulates the effect of light from a candle and is often used to create a soft, warm, shimmering atmosphere.

Brightness: 0% -100% (in 1% increment)

Switch: Turn on/off the effect

Speed: 1-100

9.7 Fire

This effect simulates the effect of light from flame and is often used to create a bright, warm, shimmering atmosphere.

Brightness: 0% -100% (in 1% increment)

Switch: Turn on/off the effect

Speed: 1-100

9.8 Firework

This effect simulates the effect of light from fireworks and is often used to create a gorgeous, colorful, romantic atmosphere.

Brightness: 0% -100% (in 1% increment)

Switch: Turn on/off the effect

Speed: 1-100

Embers: 1-100

9.9 Explosion

This effect simulates the effect of light from explosion and is often used to create a bright, fierce, shimmering atmosphere.

Brightness: 0% -100% (in 1% increment)

Switch: Turn on/off the effect

Trigger: A (Auto) / M (Manual)

CCT: 2800K-6500K

Speed: 1-100

Embers: 1-100

9.10 Welding

This effect simulates the effect of light from welding and is often used to create a hot, mechanical atmosphere.

Brightness: 0% -100% (in 1% increment)

Switch: Turn on/off the effect

CCT: 2800K-6500K

Speed: 1-100

9.11 SOS SOS

This effect simulates the flashing effect of an SOS signal and is often used to create a dangerous, distress or emergency atmosphere.

Brightness: 0% -100% (in 1% increment)

Switch: Turn on/off the effect

CCT: 2800K-6500K

Note: Please turn the select dial to adjust the parameters, then press and turn it to the next parameter. Select manual, the effect can be triggered once by pressing the select dial once. After a certain effect is set, press SET button can return to the 11 effects interface.

NFC Addition

Use the NFC function of smartphone and NFC chip of the light fixture to connect them, then add the light fixture to **【Godox Light】** app.

10.1 Preconditions: light fixture supports NFC addition, **【Godox Light】** app is V3.2.4 or above, Bluetooth and NFC functions of smartphone are turned on.

10.2 Operation Instructions: subject to the fulfillment of preconditions, turn on the **【Godox Light】** app and enter the corresponding scene, click **【+】** to select **【NFC Addition】** function, bring the NFC sensing area of smartphone near the sensing area of light fixture to scan to add in **【NFC Addition】** interface, bulk addition is also supported.

Note: Android systems can complete the addition by directly closing the sensing area, while iOS system need to click the  icon on the right top and wait for the pop-up window then add.

Illuminance Data

CCT	Unit	0.5m	1m	2m
2800K	lux	≈ 3550	≈ 969	≈ 251
	fc	≈ 330	≈ 90	≈ 23
3200K	lux	≈ 3710	≈ 985	≈ 255
	fc	≈ 345	≈ 92	≈ 24
4300K	lux	≈ 3830	≈ 1030	≈ 266
	fc	≈ 356	≈ 96	≈ 25
5600K	lux	≈ 4000	≈ 1070	≈ 276
	fc	≈ 372	≈ 100	≈ 26
6500K	lux	≈ 4160	≈ 1110	≈ 286
	fc	≈ 386	≈ 103	≈ 27

Technical Data

Model	P260C Pro
CCT	2800K-6500K
Input Power	45W
CRI	Average ≥ 98
TLCI	Average ≥ 98
Controlling Methods	Bluetooth Control/Light Body Control
Working Environment Temperature	-10°C ~40 °C
Dimension	≈12.91"*9.49"*1.06"
Net Weight	≈1kg

Specifications and data may subject to changes without notice.

EN

This device contains licence-exempt transmitter(s)/receiver(s) that comply with Innovation, Science and Economic Development Canada's licence-exempt RSS(s). Operation is subject to the following two conditions:

1. This device may not cause interference.
2. This device must accept any interference, including interference that may cause undesired operation of the device.

FR

L'émetteur/récepteur exempt de licence contenu dans le présent appareil est conforme aux CNR d'Innovation, Sciences et Développement économique Canada applicables aux appareils radio exempts de licence. L'exploitation est autorisée aux deux conditions suivantes :

1. L'appareil ne doit pas produire de brouillage;
2. L'appareil doit accepter tout brouillage radioélectrique subi, même si le brouillage est susceptible d'en compromettre le fonctionnement.

FCC Statement

This device complies with part 15 of the FCC Rules. Operation is subject to the following two conditions:

- (1) This device may not cause harmful interference, and
- (2) this device must accept any interference received, including interference that may cause undesired operation.

Any Changes or modifications not expressly approved by the party responsible for compliance could void the user's authority to operate the equipment.

Note: This equipment has been tested and found to comply with the limits for a Class B digital device, pursuant to part 15 of the FCC Rules. These limits are designed to provide reasonable protection against harmful interference in a residential installation. This equipment generates uses and can radiate radio frequency energy and, if not installed and used in accordance with the instructions, may cause harmful interference to radio communications. However, there is no guarantee that interference will not occur in a particular installation. If this equipment does cause harmful interference to radio or television reception, which can be determined by turning the equipment off and on, the user is encouraged to try to correct the interference by one or more of the following measures:

- Reorient or relocate the receiving antenna.
- Increase the separation between the equipment and receiver.
- Connect the equipment into an outlet on a circuit different from that to which the receiver is connected.
- Consult the dealer or an experienced radio/TV technician for help.

The device has been evaluated to meet general RF exposure requirement.

The device can be used in portable exposure condition without restriction.

Warning

Operating frequency:2402MHz – 2480MHz (BT)

Maximum EIRP Power: 4.81dBm

Declaration of Conformity

GODOX Photo Equipment Co.,Ltd. hereby declares that this equipment are in compliance with the essential requirements and other relevant provisions of Directive 2014/53/EU. In accordance with Article 10(2) and Article 10(10), this product is allowed to be used in all EU member states.For more information of DoC, Please click this web link:

<https://www.godox.com/eu-declaration-of-conformity/>

The device complies with RF specifications when the device used at 0mm from your body.

产品保修

尊敬的用户, 本保修卡是申请保修服务的重要凭证, 请您配合销售商填写并妥善保管, 谢谢!

产品信息	型号	产品条码
用户信息	姓名	联系电话
	通信地址	
销售商信息	名称	
	联系电话	
	通信地址	
	销售日期	
备注		

注: 此表应由销售商盖章确认。

产品信息

本文件适用于相关《产品保修信息》(见后面说明)所列产品,其他非属此范围的产品或部件(如促销品、赠品及其他出厂后附加的部件等)不在此保修承诺内。

保修期

产品及部件的相应保修期按相关的《产品保修信息》执行。保修期自产品首次购买日起算, 购买日以购买产品时保修卡登记日期为准。

如何获得保修服务

您可直接与产品销售商或授权服务机构联系, 也可拨打神牛产品售后服务电话, 与我们联系, 由我们的服务人员为您安排服务。申请保修时, 您应提供有效的保修卡作为保修凭证, 方可获得保修。如您不能提供有效的保修卡, 则在我们确认产品或部件属于保修范围的情况下, 也可以为您提供保修, 但这不作为我们的义务。

不适用保修情况

如产品存在下列情况，本文件项下的保证和服务将不适用：①产品或部件超过相应保修期；②错误或不当使用、维护或保管导致的故障或损坏，如：不当搬运；非按产品合理预期用途使用；不当插拔外接设备；跌落或外力挤压；接触或暴露于不当温度、溶剂、酸碱、水浸或潮湿环境；③由非神牛授权机构或人员安装、修理、更改、添加或拆卸造成的故障或损坏；④产品或部件原有识别信息被修改变更或删除；⑤无有效保修卡；⑥使用非合法授权、非标准或非公开发行的软件造成的故障或损坏；⑦因不可抗力或意外事件造成的故障或损坏；⑧其他非因产品本身质量问题导致的故障或损坏。遇上述情况，您应向相关责任方寻求解决，神牛对此不承担任何责任。因非在保修期或保修范围内的部件、附件或软件导致产品不能正常使用的，不是保修范围内的故障。产品使用过程中正常的脱色，磨损和消耗，不是保修范围内的故障。

产品保修和服务支持信息

产品的保修期和服务类型按以下《产品保修信息》执行：

产品类别	选件名称	保修期(月)	保修服务类型
部件	电路板	12	客户送修
	电池	3	客户送修
	充电器等带电性能的部件。	12	客户送修
其他	如外壳、保护罩、锁紧装置、包装等。	无	无保修

神牛产品售后服务电话 0755-29609320-8062

Warranty

Dear customers, as this warranty card is an important certificate to apply for our maintenance service, please fill in the following form in coordination with the seller and safe-keep it. Thank you!

Product Information	Model	Product Code Number
Customer Information	Name	Contact Number
	Address	
Seller Information	Name	
	Contact Number	
	Address	
	Date of Sale	
Note		

Note: This form shall be sealed by the seller.

Applicable Products

Applicable ProductsThe document applies to the products listed on the Product Maintenance Information (see below for further information). Other products or accessories (e.g. promotional items,giveaways and additional accessories attached,etc.) are not included in this warranty scope.

Warranty Period

The warranty period of products and accessories isimplemented according to the relevant Product Maintenance Information. The warranty period is calculated from the day(purchase date) when the product is bought for the first time,And the purchase date is considered as the date registered onthe warranty card when buying the product.

How to Get the Maintenance Service

If maintenance service is needed, you can directly contact the product distributor or authorized service institutions. You can also contact the Godox after-sale service call and we will offer you service. When applying for maintenance service, you should provide valid warranty card. If you cannot provide valid warranty card, we may offer you maintenance service once confirmed that the product or accessory is involved in the maintenance scope, but that shall not be considered as our obligation.

Inapplicable Cases

The guarantee and service offered by this document are not applicable in the following cases:

- ① The product or accessory has expired its warranty period;
- ② Breakage or damage caused by inappropriate usage, maintenance or preservation, such as improper packing, improper use, improper plugging in/out external equipment, falling off or squeezing by external force, contacting or exposing to the improper temperature, solvent, acid, base, flooding and damp environments, etc;
- ③ Breakage or damage caused by non-authorized institution or staff in the process of installation, maintenance, alternation, addition and detachment;
- ④ The original identifying information of product or accessory is modified, alternated, or removed;
- ⑤ No valid warranty card;
- ⑥ Breakage or damage caused by using illegally authorized, nonstandard or non-public released software;
- ⑦ Breakage or damage caused by force majeure or accident;
- ⑧ Breakage or damage that could not be attributed to the product itself. Once met these situations above, you should seek solutions from the related responsible parties and Godox assumes no responsibility. The damage caused by parts, accessories and software that beyond the warranty period or scope is not included in our maintenance scope. The normal discoloration, abrasion and consumption are not the breakage within the maintenance scope.

Maintenance and Service Support Information

The warranty period and service types of products are implemented according to the following Product Maintenance Information:

Product Type	Name	Maintenance Period(month)	Warranty Service Type
Parts	Circuit board	12	Customer sends the product to designated site
	Battery	3	Customer sends the product to designated site
	Electrical parts e.g.battery charger, etc.	3	Customer sends the product to designated site
Other Items	Lamp body, lamp cover, locking device, package, etc.	No	Without warranty

Godox After-sale Service Call +86-755-29609320(8062)

合格证
QC PASS



Wechat
Official Account
神牛微信公众号

深圳市神牛摄影器材有限公司

地址：深圳市宝安区福海街道塘尾社区耀川工业园厂房2栋
电话：0755-29609320 (8062) 传真：0755-25723423 邮箱：godox@godox.com

GODOX Photo Equipment Co., Ltd.

Add.: Building 2, Yaochuan Industrial Zone Tangwei Community, Fuhai Street, Bao'an District, Shenzhen
518103, China Tel: +86-755-29609320(8062) Fax: +86-755-25723423 E-mail: godox@godox.com

www.godox.com

Made in China | 705-P260CP-00

