

Dell PowerEdge R7625

Installation and Service Manual

Notes, cautions, and warnings

 **NOTE:** A NOTE indicates important information that helps you make better use of your product.

 **CAUTION:** A CAUTION indicates either potential damage to hardware or loss of data and tells you how to avoid the problem.

 **WARNING:** A WARNING indicates a potential for property damage, personal injury, or death.

Chapter 1: About this document	8
Chapter 2: System overview	9
Front view of the system.....	9
Left control panel view.....	12
Right control panel view.....	13
Rear view of the system.....	14
Inside the system.....	18
Locating the Express Service Code and Service Tag.....	20
System information label.....	21
Rail sizing and rack compatibility matrix.....	23
Chapter 3: Technical specifications	24
Chassis dimensions	25
System weight.....	25
Processor specifications.....	26
PSU specifications.....	26
Cooling fan specifications.....	27
Supported operating systems.....	27
System battery specifications.....	28
Expansion card riser specifications.....	28
Memory specifications.....	28
Storage controller specifications.....	29
Drives.....	29
Ports and connectors specifications.....	30
NIC port specifications.....	30
Serial connector specifications.....	30
USB ports specifications.....	30
VGA ports specifications.....	30
Video specifications.....	31
Environmental specifications.....	31
Thermal air restrictions.....	33
Thermal restriction matrix.....	34
Chapter 4: Initial system setup and configuration	41
Setting up the system.....	41
iDRAC configuration.....	41
Options to set up iDRAC IP address.....	41
Options to log in to iDRAC.....	42
Resources to install operating system.....	43
Options to download drivers and firmware	43
Options to download and install OS drivers	43
Downloading drivers and firmware.....	44

Chapter 5: Pre-operating system management applications.....	45
System Setup.....	45
System BIOS.....	46
iDRAC Settings utility.....	62
Device Settings.....	62
Dell Lifecycle Controller.....	62
Embedded system management.....	62
Boot Manager.....	62
PXE boot.....	63
Chapter 6: Minimum to POST and system management configuration validation.....	64
Minimum configuration to POST	64
Configuration validation.....	64
Error messages.....	65
Chapter 7: Installing and removing system components.....	66
Safety instructions.....	66
Before working inside your system.....	67
After working inside your system.....	67
Recommended tools.....	67
Optional front bezel.....	68
Removing the front bezel.....	68
Installing the front bezel.....	69
System cover.....	69
Removing the system cover.....	69
Installing the system cover.....	70
Drive backplane cover.....	71
Removing the drive backplane cover.....	71
Installing the drive backplane cover.....	72
Air shroud.....	74
Removing the air shroud.....	74
Installing the air shroud.....	74
Removing the GPU air shroud top cover.....	75
Installing the GPU air shroud top cover.....	76
Removing the GPU air shroud filler.....	77
Installing the GPU air shroud filler.....	78
Removing the GPU air shroud.....	79
Installing the GPU air shroud.....	80
Removing the 2 x 2.5-inch rear drive module air shroud.....	81
Installing the 2 x 2.5-inch rear drive module air shroud.....	82
Removing the 4 x 2.5-inch rear drive module air shroud.....	83
Installing the 4 x 2.5-inch rear drive module air shroud.....	83
Cooling fan.....	84
Removing the cooling fan cage assembly	84
Installing the cooling fan cage assembly.....	85
Removing a cooling fan.....	86
Installing a cooling fan.....	87
Removing a 2 x 2.5-inch rear drive module cooling fan.....	88

Installing a 2 x 2.5-inch rear drive module cooling fan.....	89
Removing a 4 x 2.5-inch rear drive module cooling fan.....	90
Installing a 4 x 2.5-inch rear drive module cooling fan.....	90
Drives.....	91
Removing a drive blank.....	91
Installing a drive blank.....	92
Removing the drive carrier.....	92
Installing the drive carrier.....	93
Removing the drive from the drive carrier.....	94
Installing the drive into the drive carrier.....	95
Rear drive module.....	96
Removing the 2 x 2.5-inch rear drive module.....	96
Installing the 2 x 2.5-inch rear drive module.....	97
Removing the 4 x 2.5-inch rear drive module.....	98
Installing the 4 x 2.5-inch rear drive module.....	99
Drive backplane.....	100
Drive backplane.....	100
Removing the drive backplane	103
Installing the drive backplane.....	104
Side wall brackets.....	105
Removing the side wall bracket.....	105
Installing the side wall bracket.....	107
Cable routing.....	109
PERC module.....	137
Removing the front mounting front PERC module.....	137
Installing the front mounting front PERC module.....	138
Removing the adapter PERC module.....	139
Installing the adapter PERC module.....	140
System memory.....	142
System memory guidelines.....	142
General memory module installation guidelines.....	144
Removing a memory module.....	144
Installing a memory module.....	145
Processor and heat sink.....	147
Removing a heat sink.....	147
Removing the Direct Liquid Cooling module.....	148
Removing the processor.....	149
Installing the processor.....	151
Installing the heat sink.....	153
Installing the Direct Liquid Cooling module.....	155
Expansion cards and expansion card risers.....	157
Expansion card installation guidelines.....	157
Removing the expansion card risers.....	187
Installing the expansion card risers.....	190
Removing expansion card from the expansion card riser.....	192
Installing an expansion card into the expansion card riser.....	193
Removing the full length expansion card risers.....	195
Installing the full length expansion card risers.....	197
Removing a GPU.....	200
Installing a GPU.....	202

Optional serial COM port.....	205
Removing the serial COM port.....	205
Installing the serial COM port.....	206
BOSS-N1 module.....	208
Removing the BOSS-N1 module blank.....	208
Installing the BOSS-N1 module blank.....	208
Removing the BOSS card filler.....	209
Installing the BOSS card filler.....	210
Removing the BOSS-N1 controller card module.....	210
Installing the BOSS-N1 controller card module.....	212
System battery	214
Replacing the system battery.....	214
Optional internal USB card.....	216
Removing the internal USB card.....	216
Installing the internal USB card.....	217
Intrusion switch module.....	217
Removing the intrusion switch.....	217
Installing the intrusion switch.....	218
Optional OCP card.....	219
Removing the OCP card.....	219
Installing the OCP card.....	221
Power supply unit.....	222
Hot spare feature.....	222
Removing a power supply unit blank.....	223
Installing a power supply unit blank.....	223
Removing a power supply unit adapter blank.....	223
Installing a power supply unit adapter blank.....	224
Removing a power supply unit.....	225
Installing a power supply unit.....	226
Trusted Platform Module.....	227
Upgrading the Trusted Platform Module.....	227
Initializing TPM for users.....	228
Initializing the TPM 2.0 for users.....	228
System board.....	229
Removing the system board.....	229
Installing the system board.....	230
Restoring Service Tag using Easy Restore.....	231
Manually update the Service Tag.....	232
LOM card and rear I/O board.....	232
Removing the LOM card and rear I/O board.....	232
Installing the LOM card and rear I/O board.....	233
Control panel.....	234
Removing the right control panel.....	234
Installing the right control panel.....	235
Removing the left control panel.....	236
Installing the left control panel.....	237
Chapter 8: Jumpers and connectors.....	239
System board connectors.....	239
System board jumper settings.....	241

Disabling a forgotten password.....	241
Chapter 9: System diagnostics and indicator codes.....	243
Status LED indicators.....	243
System health and system ID indicator codes.....	244
iDRAC Quick Sync 2 indicator codes.....	245
iDRAC Direct LED indicator codes.....	246
LCD panel.....	246
NIC indicator codes.....	247
Power supply unit indicator codes.....	247
Drive indicator codes.....	249
Chapter 10: Using system diagnostics.....	250
Dell Embedded System Diagnostics.....	250
Running the Embedded System Diagnostics from Boot Manager.....	250
Running the Embedded System Diagnostics from the Dell Lifecycle Controller.....	250
System diagnostic controls.....	251
Chapter 11: System board diagnostic LED indicators.....	252
Chapter 12: Enhanced Preboot System Assessment.....	253
Chapter 13: Getting help.....	255
Recycling or End-of-Life service information.....	255
Contacting Dell Technologies.....	255
Accessing system information by using QRL.....	256
Quick Resource Locator for PowerEdge R7625 system.....	256
Receiving automated support with SupportAssist	256
Chapter 14: Documentation resources.....	257
Chapter 15: Documentation resources.....	259

About this document

This document provides an overview about the system, information about installing and replacing components, diagnostic tools, and guidelines to be followed while installing certain components.

System overview

The PowerEdge R7625 system is a 2U server that supports:

- Two AMD EPYC 4th Generation 9004 series processor with up to 128 cores
- Optional Direct Liquid Cooling (DLC) for required CPUs and/or configurations
- Up to 24 RDIMMs, with up to 6 TB of memory and speeds up to 4800 MT/s
- Two redundant AC or DC power supply units
- Up to 8 x 3.5-inch SATA/SAS drives or 8 x 2.5 SATA/SAS/NVMe or 12 x 3.5-inch SATA/SAS or 16 x 2.5-inch SATA/SAS/NVMe 24 x 2.5-inch SATA/SAS/NVMe (HDD/SSD) drives
- PCI Express® (PCIe) 5.0 enabled expansion slots
- Network interface technologies to cover Network Interface Card (NIC)

NOTE: For more information about how to hot swap NVMe PCIe SSD U.2 device, see the *Dell Express Flash NVMe PCIe SSD User's Guide* at <https://www.dell.com/support> > **Browse all Products** > **Data Center Infrastructure** > **Storage Adapters & Controllers** > **Dell PowerEdge Express Flash NVMe PCIe SSD** > **Documentation** > **Manuals and Documents**.

NOTE: All instances of SAS, SATA drives are referred to as drives in this document, unless specified otherwise.

CAUTION: Do not install GPUs, network cards, or other PCIe devices on your system that are not validated and tested by Dell. Damage caused by unauthorized and invalidated hardware installation will null and void the system warranty.

Topics:

- [Front view of the system](#)
- [Rear view of the system](#)
- [Inside the system](#)
- [Locating the Express Service Code and Service Tag](#)
- [System information label](#)
- [Rail sizing and rack compatibility matrix](#)

Front view of the system

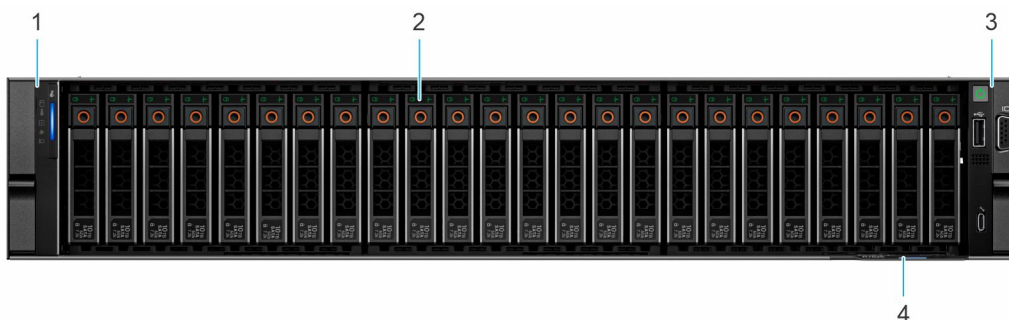

Figure 1. Front view of 24 x 2.5-inch drive system

Table 1. Features available on the front of the system

Item	Ports, panels, and slots	Icon	Description
1	Left control panel	N/A	Contains the system health, system ID and the status LED indicator.

Table 1. Features available on the front of the system (continued)

Item	Ports, panels, and slots	Icon	Description
2	Drive	N/A	Enables you to install drives that are supported on your system.
3	Right control panel	N/A	Contains the power button, VGA port, USB port, iDRAC Direct (Micro-AB USB) port and the iDRAC Direct status LED.
4	Information tag	N/A	The Express Service Tag is a slide-out label panel that contains system information such as Service Tag, NIC, MAC address, and so on. If you have opted for the secure default access to iDRAC, the Information tag will also contain the iDRAC secure default password.



Figure 2. Front view of 16 x 2.5-inch drive system

Table 2. Features available on the front of 16 x 2.5-inch drive system

Item	Ports, panels, and slots	Icon	Description
1	Left control panel	N/A	Contains the system health, system ID, and the status LED indicator.
2	Drive	N/A	Enables you to install drives that are supported on your system.
3	Right control panel	N/A	Contains the power button with integrated power LED, 1 x VGA port, 1 x 2.0 USB port, iDRAC Direct (Micro-AB USB) port, and the iDRAC Direct status LED.
4	Information tag	N/A	The Express Service Tag is a slide-out label panel that contains system information such as Service Tag, NIC, MAC address, and so on. If you have opted for the secure default access to iDRAC, the Information tag also contain the iDRAC secure default password.

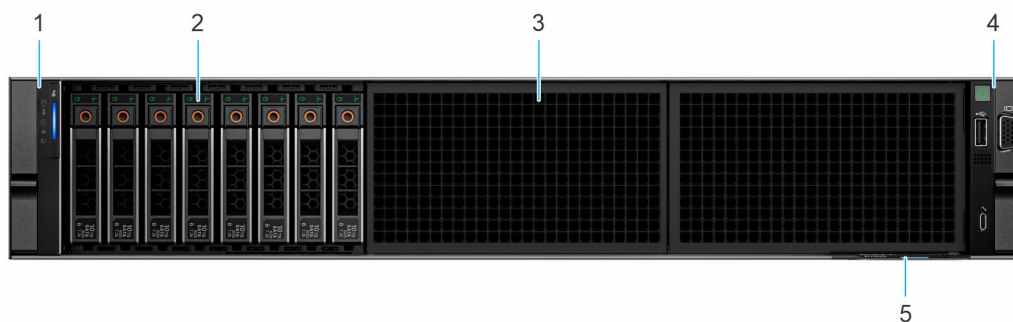

Figure 3. Front view of 8 x 2.5-inch drive system

Table 3. Features available on the front of the system

Item	Ports, panels, and slots	Icon	Description
1	Left control panel	N/A	Contains the system health, system ID and the status LED indicator.

Table 3. Features available on the front of the system (continued)

Item	Ports, panels, and slots	Icon	Description
2	Drive	N/A	Enables you to install drives that are supported on your system.
3	Drive blank	N/A	Enables you to install drive blank.
4	Right control panel	N/A	Contains the power button, VGA port, USB port, iDRAC Direct (Micro-AB USB) port and the iDRAC Direct status LED.
5	Information tag	N/A	The Information tag is a slide-out label panel that contains system information such as Service Tag, NIC, MAC address, and so on. If you have opted for the secure default access to iDRAC, the Information tag will also contain the iDRAC secure default password.

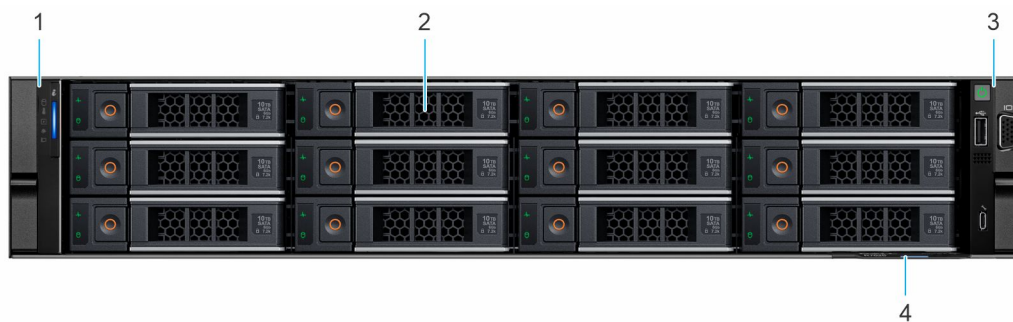

Figure 4. Front view of 12 x 3.5-inch drive system

Table 4. Features available on the front of the system

Item	Ports, panels, and slots	Icon	Description
1	Left control panel	N/A	Contains the system health, system ID and the status LED indicator.
2	Drive	N/A	Enables you to install drives that are supported on your system.
3	Right control panel	N/A	Contains the power button, VGA port, USB port, iDRAC Direct (Micro-AB USB) port and the iDRAC Direct status LED.
4	Information tag	N/A	The Information tag is a slide-out label panel that contains system information such as Service Tag, NIC, MAC address, and so on. If you have opted for the secure default access to iDRAC, the Information tag will also contain the iDRAC secure default password.

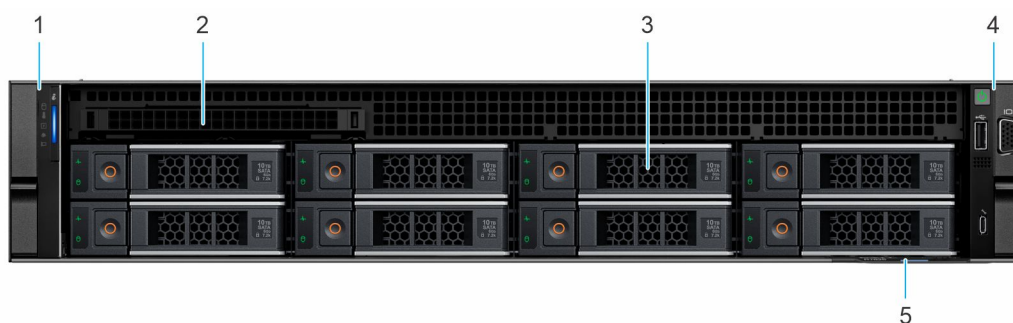

Figure 5. Front view of 8 x 3.5-inch drive system

Table 5. Features available on the front of the system

Item	Ports, panels, and slots	Icon	Description
1	Left control panel	N/A	Contains the system health, system ID and the status LED indicator.
2	Optical blank (optional)	N/A	One optional slim SATA DVD-ROM or DVD+/-RW blank.
3	Drive	N/A	Enables you to install drives that are supported on your system.
4	Right control panel	N/A	Contains the power button, VGA port, USB port, iDRAC Direct (Micro-AB USB) port and the iDRAC Direct status LED.
5	Information tag	N/A	The Information tag is a slide-out label panel that contains system information such as Service Tag, NIC, MAC address, and so on. If you have opted for the secure default access to iDRAC, the Information tag will also contain the iDRAC secure default password.

NOTE: For more information about ports, panels, and slots, see the Technical specifications section.

Left control panel view

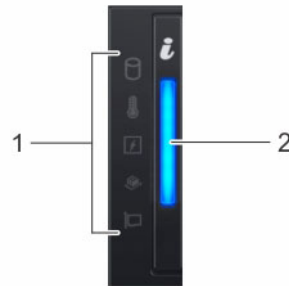

Figure 6. Left control panel

Table 6. Left control panel

Item	Indicator, button, or connector	Icon	Description
1	Status LED indicators	NA	Indicates the status of the system. For more information, see the Status LED indicators section.
2	System health and system ID	<i>i</i>	Indicates the system health. For more information, see the System health and system ID indicator codes section.

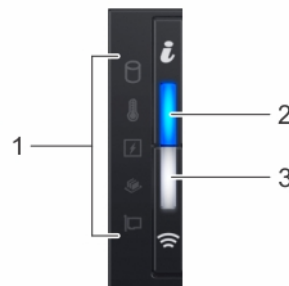





Figure 7. Left control panel with optional iDRAC Quick Sync 2 indicator

Table 7. Left control panel with optional iDRAC Quick Sync 2 indicator

Item	Indicator, button, or connector	Icon	Description
1	Status LED indicators	N/A	Indicates the status of the system. For more information, see the Status LED indicators section.
2	System health and system ID indicator		Indicates the system health. For more information, see the System health and system ID indicator codes section.
3	iDRAC Quick Sync 2 wireless indicator (optional)		Indicates if the iDRAC Quick Sync 2 wireless option is activated. The Quick Sync 2 feature allows management of the system using mobile devices. This feature aggregates hardware/firmware inventory and various system level diagnostic/error information that can be used in troubleshooting the system. You can access system inventory, Dell Lifecycle Controller logs or system logs, system health status, and also configure iDRAC, BIOS, and networking parameters. You can also launch the virtual Keyboard, Video, and Mouse (KVM) viewer and virtual Kernel-based Virtual Machine (KVM), on a supported mobile device. For more information, see the Integrated Dell Remote Access Controller User's Guide at www.dell.com/poweredgemanuals .

 **NOTE:** For more information about the indicator codes, see the [System diagnostics and indicator codes](#) section.

Right control panel view

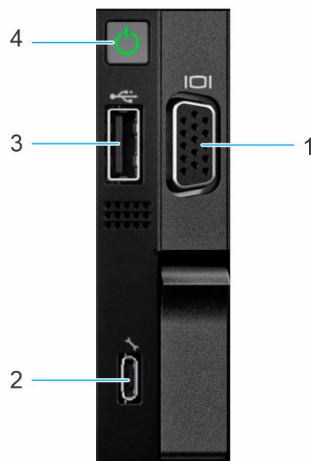

Figure 8. Right control panel view

Table 8. Right control panel





Item	Indicator or button	Icon	Description
1	VGA port		Enables you to connect a display device to the system. For more information, see the www.dell.com/poweredgemanuals section.
2	iDRAC Direct port (Micro-AB USB)		The iDRAC Direct port (Micro-AB USB) enables you to access the iDRAC Direct Micro-AB features. For more information, see the <i>Integrated Dell Remote Access Controller User's Guide</i> available at https://www.dell.com/idracmanuals .  NOTE: You can configure iDRAC Direct by using a USB to micro USB (type AB) cable, which you can connect to your laptop or tablet. Cable

Table 8. Right control panel (continued)

Item	Indicator or button	Icon	Description
			length should not exceed 3 feet (0.91 meters). Performance could be affected by cable quality.
3	USB 2.0-compliant port		The USB port is a 4-pin connector and 2.0-compliant. This port enables you to connect USB devices to the system.
4	Power button		Indicates if the system is powered on or off. Press the power button to manually power on or off the system. NOTE: Press the power button to gracefully shut down the ACPI-compliant operating system.

NOTE: For more information on the ports, see the www.dell.com/poweredgemanuals section.

Rear view of the system

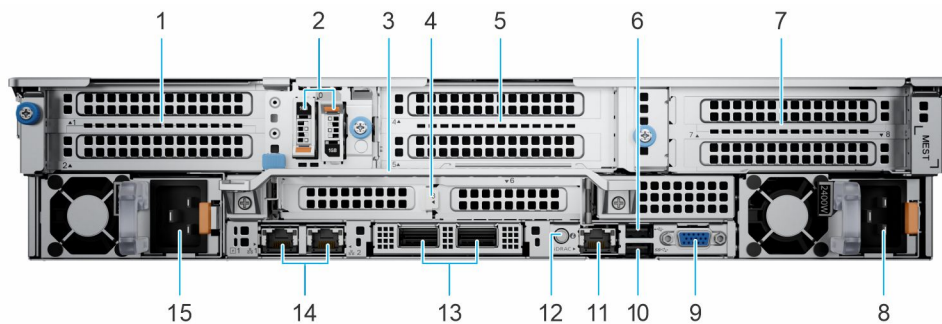

Figure 9. Rear view of the system

Table 9. Rear view of the system







Item	Ports, panels, or slots	Icon	Description
1	PCIe expansion card riser 1 (slot 1 and slot 2)	N/A	The expansion card riser enables you to connect PCI Express expansion cards. For more information , see the Expansion card installation guidelines section.
2	BOSS blank	N/A	Insert BOSS blank when BOSS module is not used.
3	Rear Handle	N/A	To lift the system.
4	PCIe expansion card riser 2 (slot 3 and slot 6)	N/A	The expansion card riser enables you to connect PCI Express expansion cards. For more information , see the Expansion card installation guidelines section.
5	PCIe expansion card riser 3 (slot 4 and slot 5)	N/A	The expansion card riser enables you to connect PCI Express expansion cards. For more information , see the Expansion card installation guidelines section.
6	USB 2.0 port (1)		The USB port is 4-pin, 2.0-compliant. This port enables you to connect USB devices to the system.
7	PCIe expansion card riser 4 (slot 7 and slot 8)	N/A	The expansion card riser enables you to connect PCI Express expansion cards. For more information on the expansion cards that are supported on your system,
8	Power supply unit (PSU 2)		For more information about the PSU configurations, see www.dell.com/poweredgemanuals section.

Table 9. Rear view of the system (continued)

Item	Ports, panels, or slots	Icon	Description
9	VGA port	N/A	Enables you to connect a display device to the system. For more information, see www.dell.com/poweredgemanuals section.
10	USB 3.0 port		The USB port is 9-pin and 3.0-compliant. This port enables you to connect USB devices to the system.
11	Dedicated iDRAC9 Ethernet port		Enables you to remotely access iDRAC. For more information, see the Integrated <i>Dell Remote Access Controller User's Guide</i> at www.dell.com/poweredgemanuals .
12	System Identification (ID) button		The System Identification (ID) button is available on the front and back of the system. Press the button to identify a system in a rack by turning on the system ID button. You can also use the system ID button to reset iDRAC and to access BIOS using the step through mode. When pressed, the system ID LED in the back panel blinks until either the front or rear button is pressed again. Press the button to toggle between on or off mode. NOTE: If the server stops responding during POST, press and hold the System ID button for more than five seconds to enter the BIOS progress mode NOTE: To reset the iDRAC (if not disabled on the iDRAC setup page by pressing F2 during system boot), press and hold the System ID button for more than 15 seconds.
13	OCP NIC card	N/A	The OCP NIC card supports OCP 3.0. The NIC ports are integrated on the OCP card which is connected to the system board.
14	NIC ports		The NIC ports are embedded on the LOM card that is connected to the system board.
15	Power supply unit (PSU1)		PSU1 is the primary PSU of the system. For more information about the PSU configurations, see www.dell.com/poweredgemanuals section.

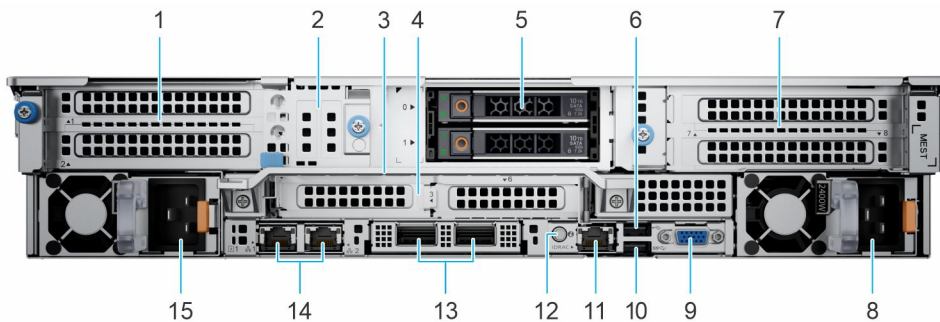









Figure 10. Rear view of the system with 2 x 2.5-inch rear drive module

Table 10. Rear view of the system

Item	Ports, panels, or slots	Icon	Description
1	PCIe expansion card riser 1 (slot 1 and slot 2)	N/A	The expansion card riser enables you to connect PCI Express expansion cards. For more information , see the Expansion card installation guidelines section.
2	BOSS blank	N/A	Insert BOSS blank when BOSS module is not used.
3	Rear Handle	N/A	To lift the system.
4	PCIe expansion card riser 2 (slot 3 and slot 6)	N/A	The expansion card riser enables you to connect PCI Express expansion cards. For more information , see the Expansion card installation guidelines section.

Table 10. Rear view of the system (continued)

Item	Ports, panels, or slots	Icon	Description
5	Rear drive module	N/A	Enables you to install drives that are supported on your system.
6	USB 2.0 port (1)		The USB port is 4-pin, 2.0-compliant. This port enables you to connect USB devices to the system.
7	PCIe expansion card riser 4 (slot 7 and slot 8)	N/A	The expansion card riser enables you to connect PCI Express expansion cards. For more information on the expansion cards that are supported on your system,
8	Power supply unit (PSU 2)		For more information about the PSU configurations, see www.dell.com/poweredgemanuals section.
9	VGA port	N/A	Enables you to connect a display device to the system. For more information, see www.dell.com/poweredgemanuals section.
10	USB 3.0 port		The USB port is 9-pin and 3.0-compliant. This port enables you to connect USB devices to the system.
11	iDRAC9 ethernet port		Enables you to remotely access iDRAC. For more information, see www.dell.com/poweredgemanuals section.
12	System Identification (ID) button		<p>The System Identification (ID) button is available on the front and back of the system. Press the button to identify a system in a rack by turning on the system ID button. You can also use the system ID button to reset iDRAC and to access BIOS using the step through mode. When pressed, the system ID LED in the back panel blinks until either the front or rear button is pressed again. Press the button to toggle between on or off mode.</p> <p>NOTE: If the server stops responding during POST, press and hold the System ID button for more than five seconds to enter the BIOS progress mode</p> <p>NOTE: To reset the iDRAC (if not disabled on the iDRAC setup page by pressing F2 during system boot), press and hold the System ID button for more than 15 seconds.</p>
13	OCP NIC card	N/A	The OCP NIC card supports OCP 3.0. The NIC ports are integrated on the OCP card which is connected to the system board.
14	NIC ports		The NIC ports are embedded on the LOM card that is connected to the system board.
15	Power supply unit (PSU1)		PSU1 is the primary PSU of the system. For more information, see www.dell.com/poweredgemanuals section.

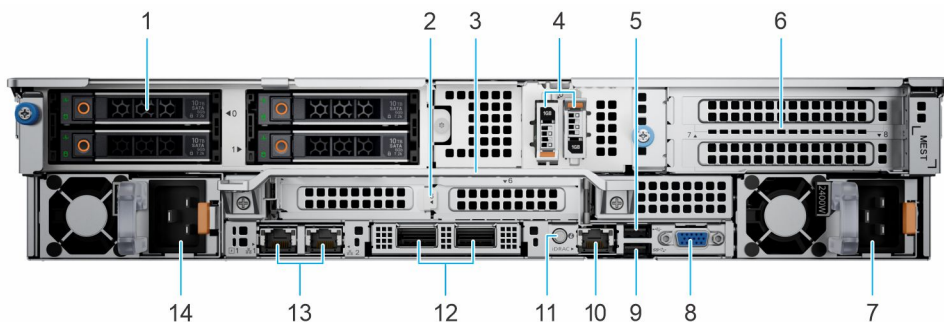









Figure 11. Rear view of the system with 4 x 2.5-inch rear drive module

Table 11. Rear view of the system

Item	Ports, panels, or slots	Icon	Description
1	Drives	N/A	Enables you to install drives that are supported on your system.

Table 11. Rear view of the system (continued)

Item	Ports, panels, or slots	Icon	Description
2	PCIe expansion card riser 2	N/A	The expansion card riser enables you to connect PCI Express expansion cards. For more information , see the Expansion card installation guidelines section.
3	Rear Handle	N/A	To lift the system.
4	BOSS blank	N/A	Insert BOSS blank when BOSS module is not used.
5	USB 2.0 port		The USB port is 4-pin, 2.0-compliant. This port enables you to connect USB devices to the system.
6	PCIe expansion card riser 4	N/A	The expansion card riser enables you to connect PCI Express expansion cards. For more information , see the Expansion card installation guidelines section.
7	Power supply unit (PSU 2)		For more information about the PSU configurations, see www.dell.com/poweredgemanuals section.
8	VGA port	N/A	Enables you to connect a display device to the system. For more information, see www.dell.com/poweredgemanuals section.
9	USB 3.0 port		The USB port is 9-pin and 3.0-compliant. This port enables you to connect USB devices to the system.
10	Dedicated iDRAC9 Ethernet port		Enables you to remotely access iDRAC. For more information, see the Integrated <i>Dell Remote Access Controller User's Guide</i> at www.dell.com/poweredgemanuals .
11	System Identification (ID) button		<p>The System Identification (ID) button is available on the front and back of the system. Press the button to identify a system in a rack by turning on the system ID button. You can also use the system ID button to reset iDRAC and to access BIOS using the step through mode. When pressed, the system ID LED in the back panel blinks until either the front or rear button is pressed again. Press the button to toggle between on or off mode.</p> <p>i NOTE: If the server stops responding during POST, press and hold the System ID button for more than five seconds to enter the BIOS progress mode</p> <p>i NOTE: To reset the iDRAC (if not disabled on the iDRAC setup page by pressing F2 during system boot), press and hold the System ID button for more than 15 seconds.</p>
12	OCP NIC card	N/A	The OCP NIC card supports OCP 3.0. The NIC ports are integrated on the OCP card which is connected to the system board.
13	NIC ports		The NIC ports that are integrated on the LOM card provide network connectivity which is connected to the system board.
14	Power supply unit (PSU1)		PSU1 is the primary PSU of the system.

i NOTE: For more information about ports, panels, and slots, see the Technical specifications section.

Inside the system

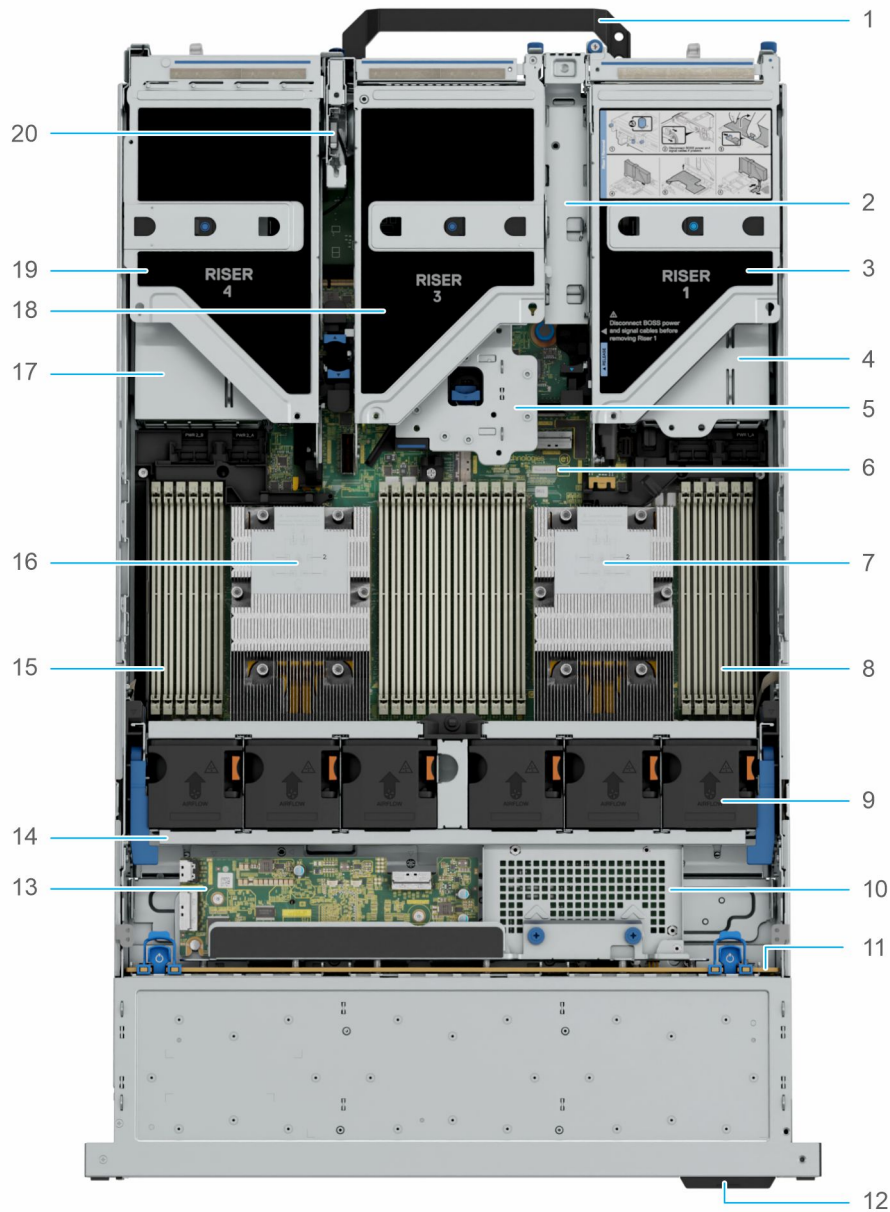

Figure 12. Inside the system

- | | |
|--|---------------------------------------|
| 1. Rear Handle | 2. BOSS N1 card slot |
| 3. Riser 1 | 4. Power supply unit (PSU 1) |
| 5. Riser 2 | 6. System board |
| 7. Heat sink for processor 1 | 8. Memory DIMM socket for processor 1 |
| 9. Cooling fans | 10. PERC Controller |
| 11. Drive backplane | 12. Service tag |
| 13. Expander | 14. Cooling fan cage assembly |
| 15. Memory DIMM socket for processor 2 | 16. Heat sink for processor 2 |
| 17. Power supply unit (PSU 2) | 18. Riser 3 |
| 19. Riser 4 | 20. Intrusion switch |

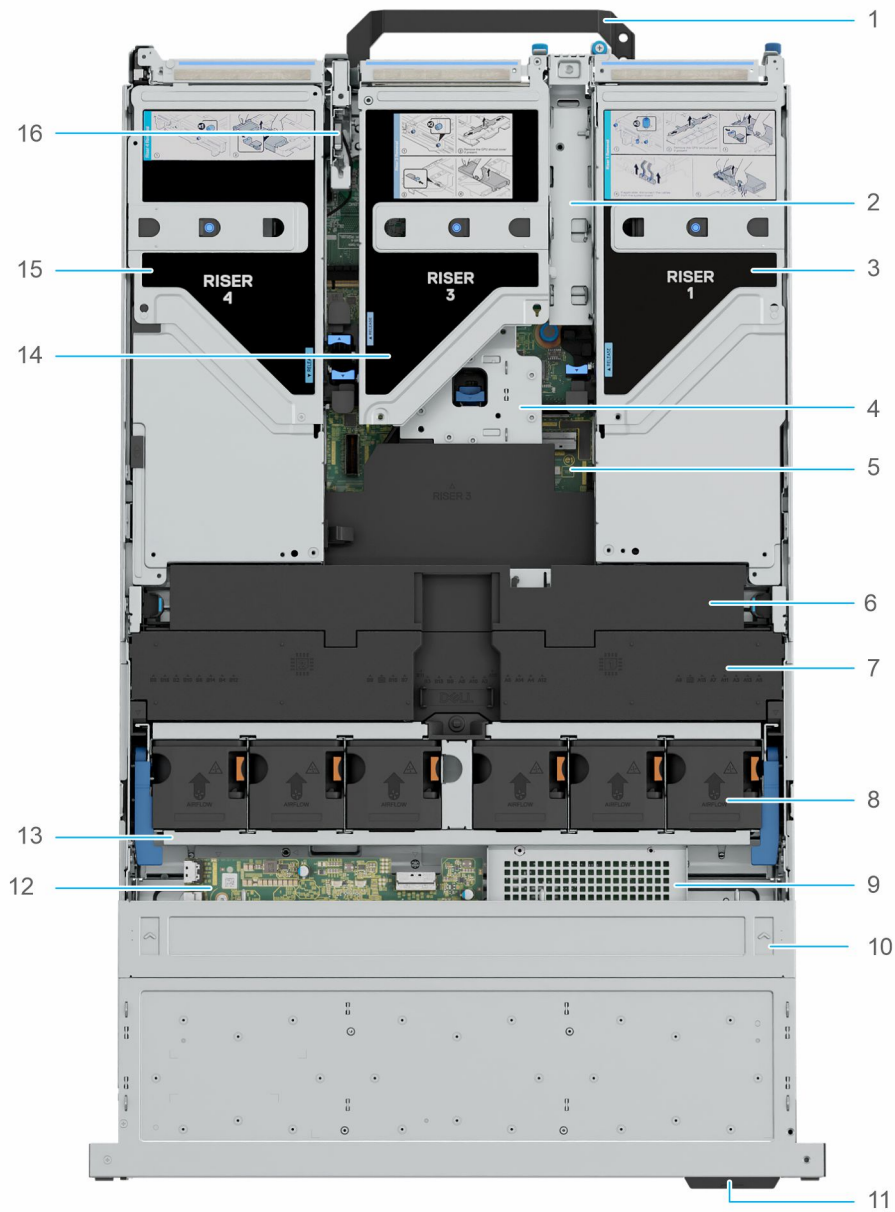

Figure 13. Inside the system with full length risers and GPU shroud

- | | |
|-------------------------------|-----------------------------|
| 1. Rear Handle | 2. BOSS N1 card slot |
| 3. Riser 1 | 4. Riser 2 |
| 5. System board | 6. GPU top cover |
| 7. GPU air shroud | 8. Cooling fans |
| 9. PERC Controller | 10. Drive backplane cover |
| 11. Service tag | 12. Expander |
| 13. Cooling fan cage assembly | 14. Riser 3 |
| 15. Riser 4 | 16. Intrusion switch module |

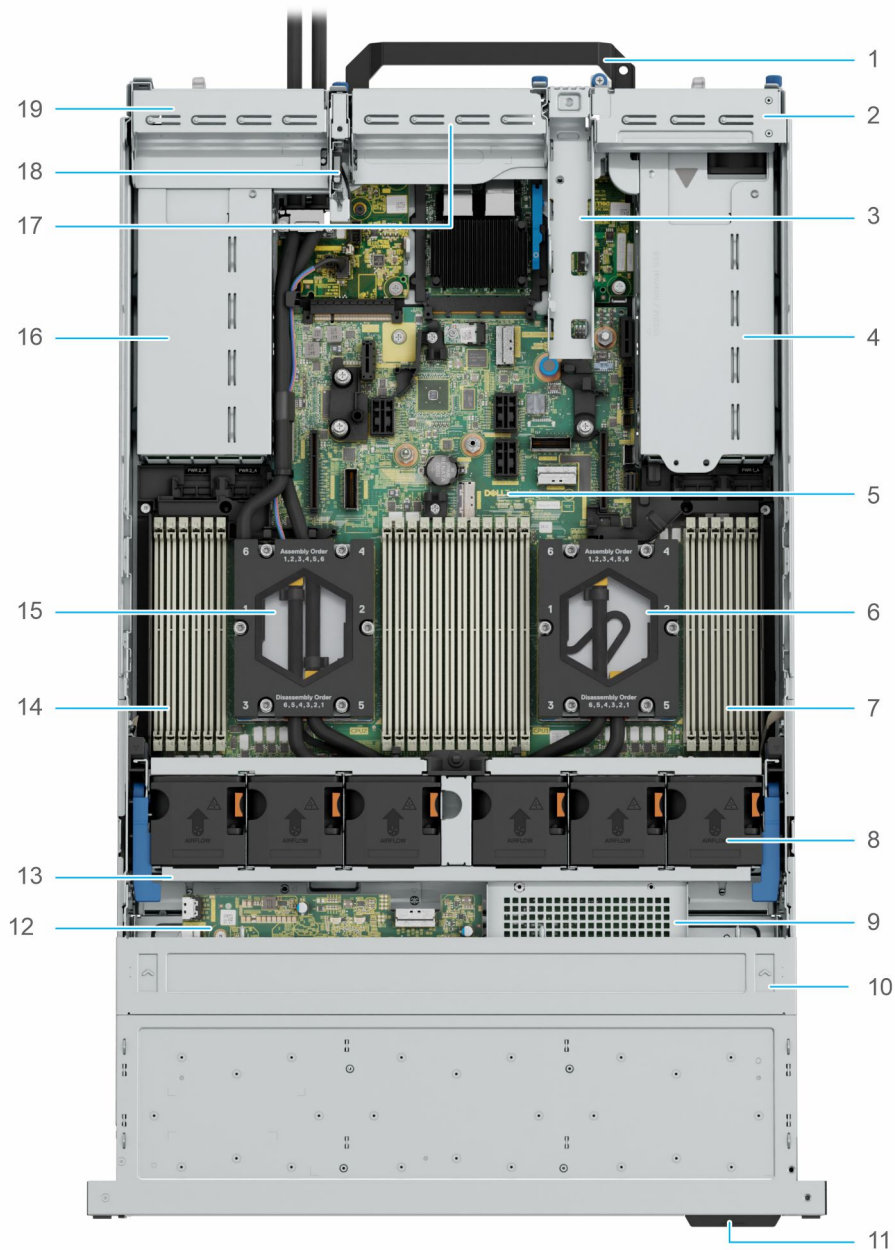

Figure 14. Inside the system with processor liquid cooling module

- | | |
|--|--|
| 1. Rear Handle | 2. Riser 1 filler |
| 3. BOSS N1 card slot | 4. Power supply unit (PSU 1) |
| 5. System board | 6. Processor 1 Liquid Cooling modules |
| 7. Memory DIMM socket for processor 1 | 8. Cooling fans |
| 9. PERC Controller | 10. Drive backplane cover |
| 11. Service tag | 12. Expander |
| 13. Cooling fan cage assembly | 14. Memory DIMM socket for processor 2 |
| 15. Processor 2 Liquid Cooling modules | 16. Power supply unit (PSU 2) |
| 17. Riser 3 filler | 18. Intrusion switch module |
| 19. Riser 4 filler | |

Locating the Express Service Code and Service Tag

The unique Express Service Code and Service Tag is used to identify the system. The information tag is located on the front of the system that includes system information such as Service Tag, Express Service Code, Manufacture date, NIC, MAC address,

GRL label, and so on. If you have opted for the secure default access to iDRAC, the Information tag also contains the iDRAC secure default password. If you have opted for iDRAC Quick Sync 2, the Information tag also contains the OpenManage Mobile (OMM) label, where administrators can configure, monitor, and troubleshoot the PowerEdge servers.

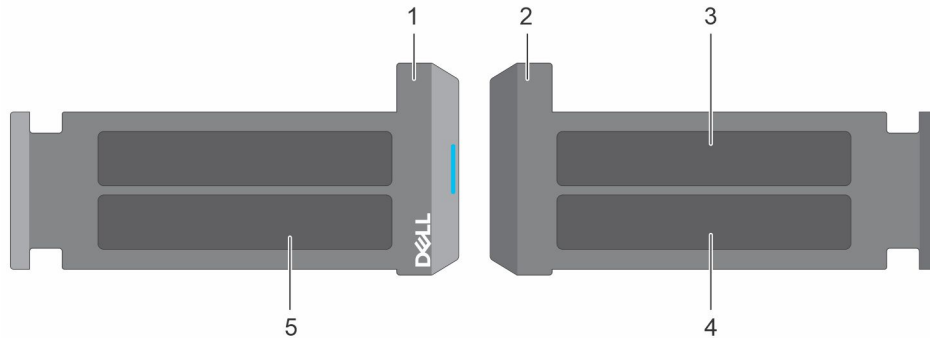

Figure 15. Locating the Express Service Code and Service tag

- | | |
|---|--|
| 1. Information tag (front view) | 2. Information tag (back view) |
| 3. OpenManage Mobile (OMM) label | 4. iDRAC MAC address and iDRAC secure password label |
| 5. Service Tag, Express Service Code, GRL label | |

The Mini Enterprise Service Tag (MEST) label is located on the rear of the system that includes Service Tag (ST), Express Service Code (Exp Svc Code), and Manufacture Date (Mfg. Date). The Exp Svc Code is used by Dell to route support calls to the appropriate personnel.

Alternatively, the Service Tag information is located on a label on left wall of the chassis.

System information label

The system information label is located on the back side of the system cover.

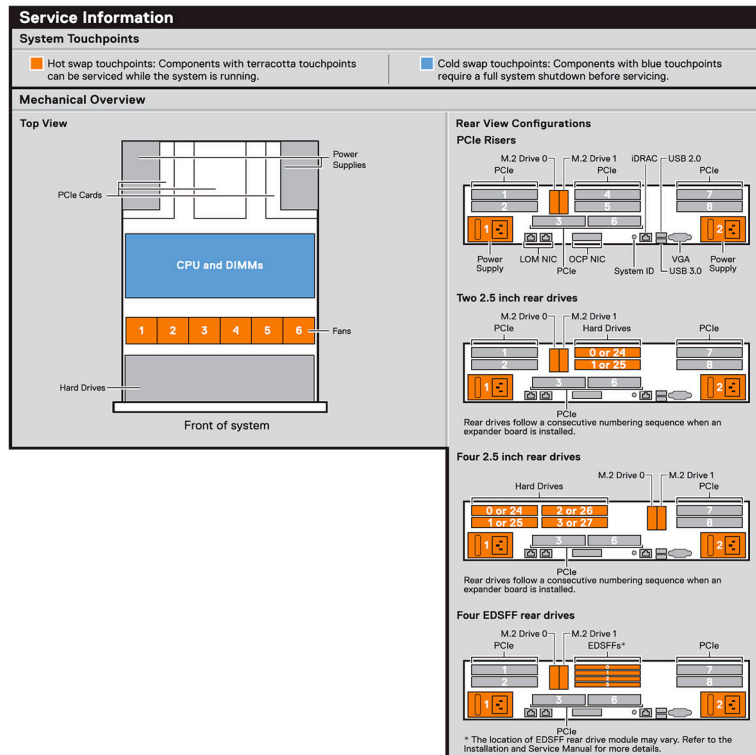

Figure 16. Service information: Touchpoints

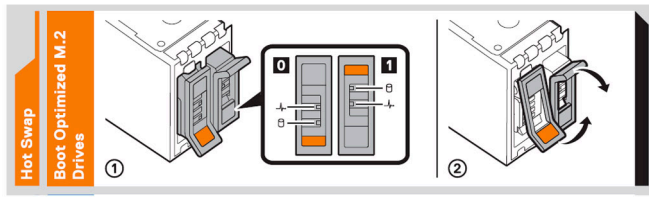

Figure 17. Service information: Hot Swap

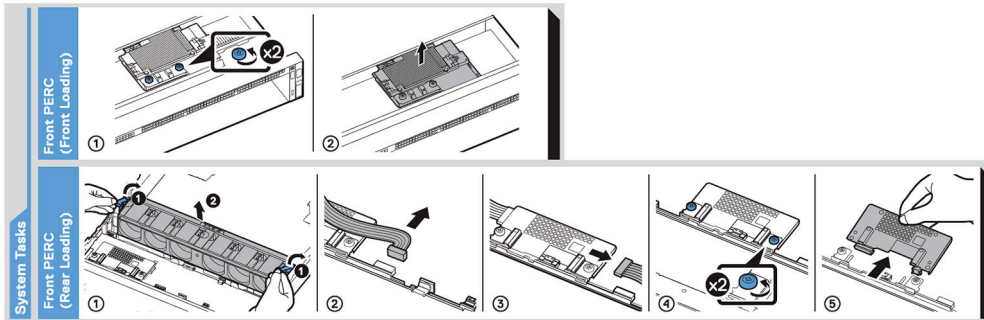

Figure 18. Service information: System Tasks

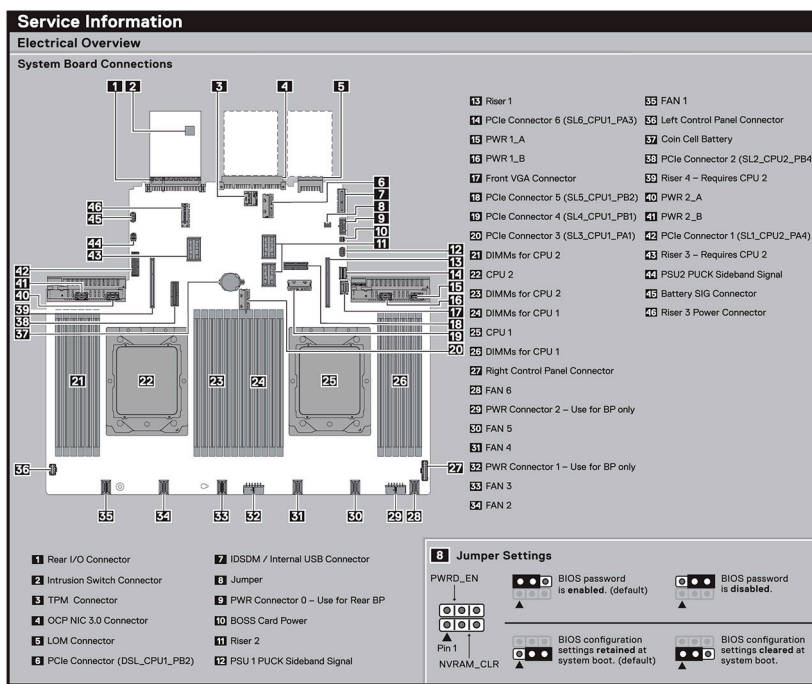

Figure 19. System board connectors

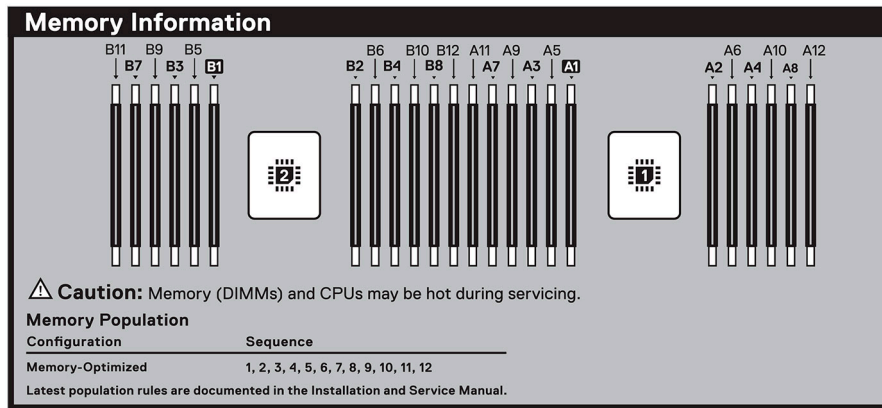

Figure 20. Memory Information

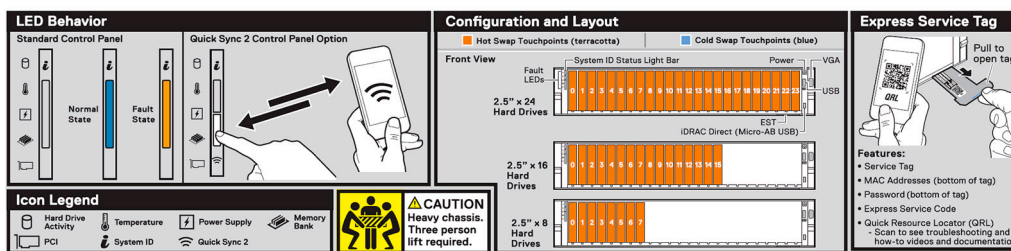

Figure 21. LED behavior, configuration and layout, express service tag for 2.5-inch HDD system

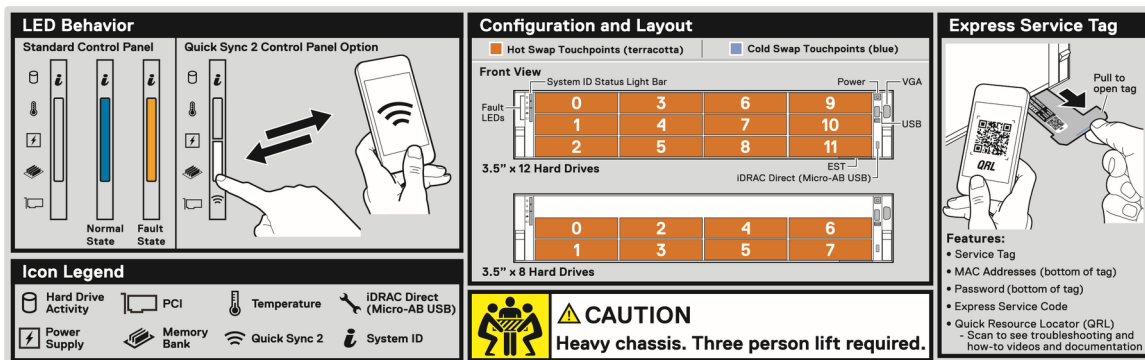

Figure 22. LED behavior, configuration and layout, express service tag for 3.5-inch HDD system

Rail sizing and rack compatibility matrix

For specific information about the rail solutions compatible with your system, see the *Dell Enterprise Systems Rail Sizing and Rack Compatibility Matrix* available at https://i.dell.com/sites/csdocuments/Business_solutions_engineering-Docs_Documents/en/rail-rack-matrix.pdf.

The document provides the information that is listed below:

- Specific details about rail types and their functionalities.
- Rail adjustability range for various types of rack mounting flanges.
- Rail depth with and without cable management accessories.
- Types of racks supported for various types of rack mounting flanges.

Technical specifications

The technical and environmental specifications of your system are outlined in this section.

Topics:

- Chassis dimensions
- System weight
- Processor specifications
- PSU specifications
- Cooling fan specifications
- Supported operating systems
- System battery specifications
- Expansion card riser specifications
- Memory specifications
- Storage controller specifications
- Drives
- Ports and connectors specifications
- Video specifications
- Environmental specifications

Chassis dimensions

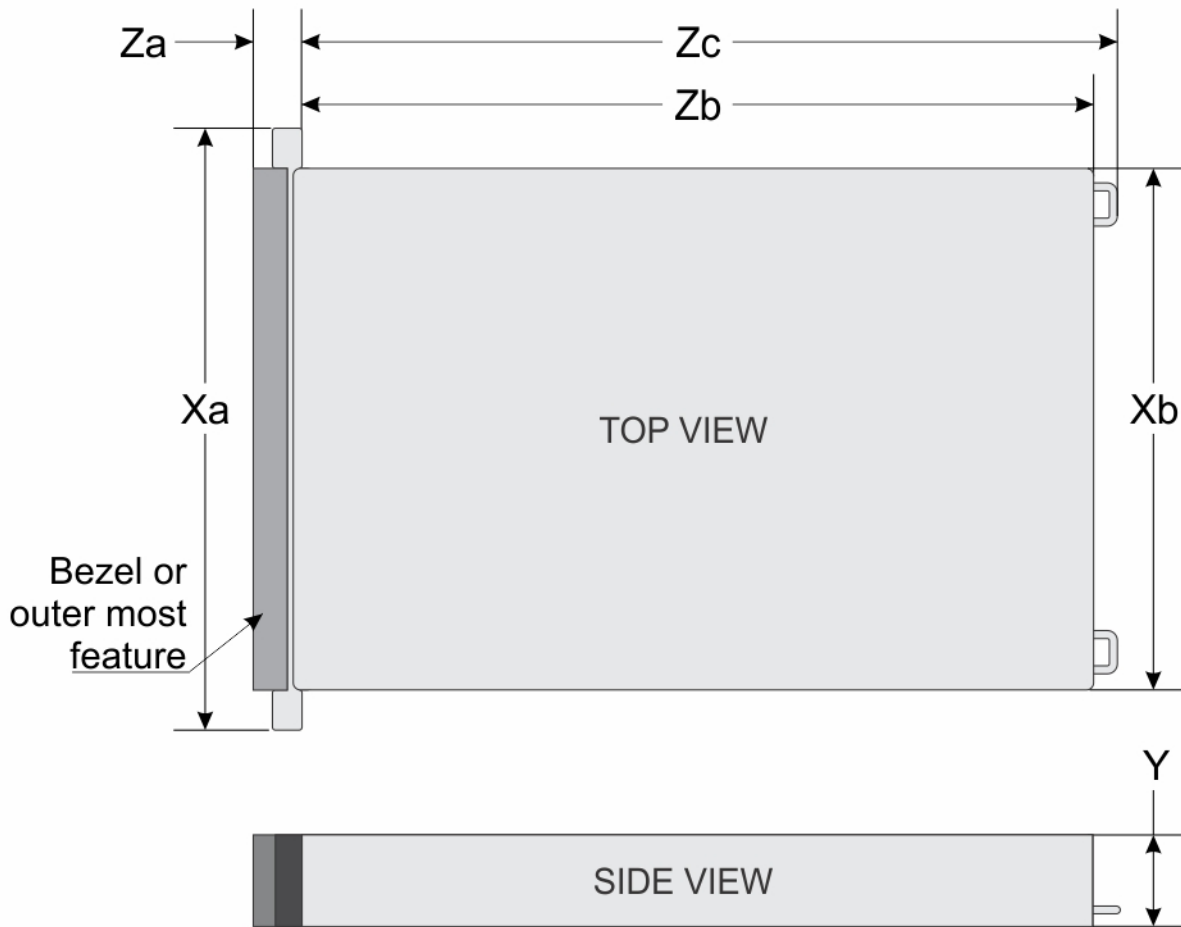

Figure 23. Chassis dimensions

Table 12. PowerEdge R7625 chassis dimensions

Xa	Xb	Y	Za	Zb	Zc
482.0 mm (18.97 inches)	434.0 mm (17.08 inches)	86.8 mm (3.41 inches)	35.84 mm (1.4 inches) With bezel 22.0 mm (0.87 inches) Without bezel	700.7 mm (27.58 inches) Ear to Rear wall	736.29 mm (28.98 inches) Ear to PSU handle

NOTE: Zb is the nominal rear wall external surface where the system board I/O connectors reside.

System weight

Table 13. PowerEdge R7625 system weight

System configuration	Maximum weight (with all drives/SSDs)
A server with fully populated drives	34.4 kg (75.84 pound)
A server without drives and PSU installed	23.3 kg (51.37 pound)

Processor specifications

Table 14. PowerEdge R7625 processor specifications

Supported processor	Number of processors supported
AMD EPYC 4 th Generation 9004 Series processor	Up to two

PSU specifications

The PowerEdge R7625 system supports up to two AC or DC power supply units (PSUs).

Table 15. PSU specifications

PSU	Class	Heat dissipation (maximum) (BTU/hr)	Frequency (Hz)	Voltage	AC		DC	Current (A)
					High line wattage	Low line wattage		
800 W Mixed Mode	Platinum	3000	50/60	100-240 V AC	800 W	800 W	N/A	9.2-4.7
	N/A	3000	N/A	240 V DC	N/A	N/A	800 W	3.8
1100 W Mixed Mode	Titanium	4125	50/60	100-240 V AC	1100 W	1050 W	N/A	12-6.3
	N/A	4125	N/A	240 V DC	N/A	N/A	1100 W	5.2
1400 W Mixed Mode	Platinum	5250	50/60	100-240 V AC	1400 W	1050 W	N/A	12-8
	N/A	5250	N/A	240 V DC	N/A	N/A	1400 W	6.6
1800 W Mixed Mode	Titanium	6610	50/60	200-240 V AC	1800 W	N/A	N/A	10
	N/A	6610	N/A	240 V DC	N/A	N/A	1800 W	8.2
2400 W Mixed Mode	Platinum	9000	50/60	100-240 V AC	2400 W	1400 W	N/A	16-13.5
	N/A	9000	N/A	240 V DC	N/A	N/A	2400 W	11.2
2800 W Mixed Mode	Titanium	10500	50/60	200-240 V AC	2800 W	N/A	N/A	15.6
	N/A	10500	N/A	240 V DC	N/A	N/A	2800 W	13.6
1100 W DC	N/A	4265	N/A	-48—(-60) V DC	N/A	N/A	1100 W	27

- NOTE:** Heat dissipation is calculated using the PSU wattage rating.
- NOTE:** When selecting or upgrading the system configuration, to ensure optimum power utilization, verify the system power consumption with the Enterprise Infrastructure Planning Tool available at Dell.com/calc.
- NOTE:** If a system with AC 1400W/1100W PSUs operates at low line 100-120 V AC, then the power rating per PSU is derated to 1050W.
- NOTE:** If a system with AC 2400W PSUs operates at low line 100-120 V AC, then the power rating per PSU is derated to 1400W.



Figure 24. PSU power cords

Table 16. PSU power cords

Form factor	Output	Power cord
Redundant 60 mm	800 W AC	C13
	1100 W AC	C13
	1100 W -48 LVDC	C13
	1400 W AC	C13
	1800 W AC	C15
Redundant 86 mm	2400 W AC	C19
	2800 W AC	C21

NOTE: C19 power cord combined with C20 to C21 jumper power cord can be used to adapt 2800 W PSU.

NOTE: C13 power cord combined with C14 to C15 jumper power cord can be used to adapt 1800 W PSU.

Cooling fan specifications

The PowerEdge R7625 system supports up to six High Performance Silver and High Performance Gold fans based on configurations.

Table 17. Cooling fan specifications

Fan type	Abbreviation	Label color	Label image
High performance Silver fans	HPR Silver	Silver	
High performance Gold fans	HPR Gold	Gold	

Supported operating systems

The PowerEdge R7625 system supports the following operating system:

- Canonical Ubuntu Server LTS
- Microsoft Windows Server with Hyper-V
- RedHat Enterprise Linux
- SUSE Linux Enterprise Server

- VMware ESXi

For more information, go to www.dell.com/ossupport.

System battery specifications

The PowerEdge R7625 system uses one CR 2032 3.0-V lithium coin cell battery.

Expansion card riser specifications

The PowerEdge R7625 system support up to 6 Full Height or 2 low profile riser slots with up to 6 x16 slots.

Table 18. Expansion card slots supported on the system board

Expansion card riser	PCIe slots	Processor connection	Height	Length	Slot width
Riser 1B	Slot 1	Processor 1	Full Height	Half Length	x8
	Slot 2				
Riser 1P	Slot 2	Processor 1	Full Height	Half Length / Full Length	x16
Riser 1Q	Slot 1	Processor 1	Full Height	Half Length	x8
	Slot 2				
Riser 1S	Slot 1	Processor 1	Full Height	Half Length / Full Length	x16
	Slot 2				
Riser 2A	Slot 3	Processor 1	Low Profile	Half Length	x16
	Slot 6	Processor 2			
Riser 3A	Slot 5	Processor 2	Full Height	Half Length / Full Length	x16
Riser 3B	Slot 4	Processor 2	Full Height	Half Length	x8
	Slot 5				
Riser 4B	Slot 7	Processor 2	Full Height	Half Length	x8
	Slot 8				
Riser 4Q	Slot 7	Processor 2	Full Height	Half Length	x8
	Slot 8				
Riser 4P	Slot 7	Processor 2	Full Height	Half Length / Full Length	x16

Memory specifications

The PowerEdge R7625 system supports the following memory specifications for optimized operation.

Table 19. Memory specifications

DIMM type	DIMM rank	DIMM capacity	Single Processor		Dual Processor	
			MINIMUM RAM	MAXIMUM RAM	MINIMUM RAM	MAXIMUM RAM
RDIMM	Single Rank	16 GB	16 GB	192 GB	32 GB	384 GB

Table 19. Memory specifications (continued)

DIMM type	DIMM rank	DIMM capacity	Single Processor		Dual Processor	
			MINIMUM RAM	MAXIMUM RAM	MINIMUM RAM	MAXIMUM RAM
	Dual Rank	32 GB	32 GB	384 GB	64 GB	768 GB
		64 GB	64 GB	768 GB	128 GB	1.5 TB
	Quad Rank	128 GB	128 GB	1.5 TB	256 GB	3 TB
	Octa Rank	256 GB	256 GB	3 TB	512 GB	6 TB

Table 20. Memory module sockets

Memory module sockets	Speed
24, 288-pin	4800 MT/s

- NOTE:** DDR4 DIMM memory is not supported.
- NOTE:** Memory DIMM slots are not hot pluggable.
- NOTE:** Do not mix DIMM module types within a memory channel. All must be RDIMM or 3DS RDIMM module types with same ECC configuration.
- NOTE:** Do not mix x4 and x8 DIMMs with a memory channel.

Storage controller specifications

The PowerEdge R7625 system supports the following controller cards:

Table 21. Storage controller cards

Supported storage controller cards
Internal controllers <ul style="list-style-type: none"> • PERC H965i • PERC H755 • PERC H755N • PERC H355
External controllers <ul style="list-style-type: none"> • HBA355e
Internal Boot <ul style="list-style-type: none"> • Boot Optimized Storage Subsystem (BOSS-N1): HWRAID 2 x M.2 NVMe SSD • USB
Software RAID <ul style="list-style-type: none"> • S160
SAS Host Bus Adapters (HBA) <ul style="list-style-type: none"> • HBA355i

Drives

The PowerEdge R7625 system supports:

- 8 x 3.5-inch hot-swappable SAS, SATA drives.
- 8 x 2.5-inch hot-swappable SAS, SATA, NVMe drives.
- 12 x 3.5-inch hot-swappable SAS, SATA drives.

- 16 x 2.5-inch hot-swappable SAS, SATA, NVMe drives.
- 24 x 2.5-inch hot-swappable SAS, SATA, NVMe drives.
- 2 x 2.5-inch (rear) hot-swappable SAS/SATA/NVMe drives
- 4 x 2.5-inch (rear) hot-swappable SAS/SATA/NVMe drives

NOTE: For more information about how to hot swap NVMe PCIe SSD U.2 device, see the *Dell Express Flash NVMe PCIe SSD User's Guide* at <https://www.dell.com/support> > **Browse all Products** > **Data Center Infrastructure** > **Storage Adapters & Controllers** > **Dell PowerEdge Express Flash NVMe PCIe SSD** > **Documentation** > **Manuals and Documents**.

Ports and connectors specifications

NIC port specifications

The PowerEdge R7625 system supports up to two 10/100/1000 Mbps Network Interface Controller (NIC) ports embedded on the LAN on Motherboard (LOM) and integrated on the Open Compute Project (OCP) cards.

Table 22. NIC port specification for the system

Feature	Specifications
LOM card (optional)	1 GbE x 2
OCP card 3.0 (optional)	1 GbE x 4, 10 GbE x 2, 10 GbE x 4, 25 GbE x 2, 25 GbE x 4

NOTE: The system allows either LOM card or an OCP card or both to be installed in the system.

NOTE: On the system board, the supported OCP PCIe width is x8; when x16 PCIe width is installed, it is downgraded to x8.

Serial connector specifications

The PowerEdge R7625 system supports one optional card type serial connector, which is a 9-pin connector, Data Terminal Equipment (DTE), 16550-compliant .

The optional serial connector card is installed similar to an expansion card filler bracket.

USB ports specifications

Table 23. PowerEdge R7625 USB specifications

Front		Rear		Internal (optional)	
USB port type	No. of ports	USB port type	No. of ports	USB port type	No. of ports
USB 2.0-compliant port	One	USB 3.0-compliant port	One	Internal USB 3.0-compliant port	One
iDRAC Direct port (Micro-AB USB 2.0-compliant port)	One	USB 2.0-compliant ports	One		

NOTE: The micro USB 2.0 compliant port can only be used as an iDRAC Direct or a management port.

VGA ports specifications

The PowerEdge R7625 system supports two DB-15 VGA port one each on the front and rear panel (optional for liquid cooling).

Video specifications

The PowerEdge R7625 system supports integrated Matrox G200 graphics controller with 16 MB of video frame buffer.

Table 24. Supported video resolution options

Resolution	Refresh rate (Hz)	Color depth (bits)
1024 x 768	60	8, 16, 32
1280 x 800	60	8, 16, 32
1280 x 1024	60	8, 16, 32
1360 x 768	60	8, 16, 32
1440 x 900	60	8, 16, 32
1600 x 900	60	8, 16, 32
1600 x 1200	60	8, 16, 32
1680 x 1050	60	8, 16, 32
1920 x 1080	60	8, 16, 32
1920 x 1200	60	8, 16, 32

Environmental specifications

Table 25. Continuous Operation Specifications for ASHRAE A2

Temperature	Specifications
Allowable continuous operations	
Temperature range for altitudes <= 900 m (<= 2953 ft)	10–35°C (50–95°F) with no direct sunlight on the equipment
Humidity percent range (non-condensing at all times)	8% RH with -12°C minimum dew point to 80% RH with 21°C (69.8°F) maximum dew point
Operational altitude de-rating	Maximum temperature is reduced by 1°C/300 m (1.8°F/984 Ft) above 900 m (2953 Ft)

Table 26. Continuous Operation Specifications for ASHRAE A3

Temperature	Specifications	
Allowable continuous operations		
Temperature range for altitudes <= 900 m (<= 2953 ft)	5–40°C (41–104°F) with no direct sunlight on the equipment	
	Excursion Limited Operation	5-35°C (41-95°F) Continuous Operation
		35-40°C (95-104°F) 10% Annual Runtime
Humidity percent range (non-condensing at all times)	8% RH with -12°C minimum dew point to 85% RH with 24°C (75.2°F) maximum dew point	
Operational altitude de-rating	Maximum temperature is reduced by 1°C/175 m (1.8°F/574 Ft) above 900 m (2953 Ft)	

Table 27. Continuous Operation Specifications for ASHRAE A4

Temperature	Specifications	
Allowable continuous operations		
Temperature range for altitudes <= 900 m (<= 2953 ft)	5–45°C (41–113°F) with no direct sunlight on the equipment	
	Excursion Limited Operation	5-35°C (41-95°F) Continuous Operation
		35-40°C (95-104°F) 10% Annual Runtime
		40-45°C (104-113°F) 1% Annual Runtime
Humidity percent range (non-condensing at all times)	8% RH with -12°C minimum dew point to 90% RH with 24°C (75.2°F) maximum dew point	
Operational altitude de-rating	Maximum temperature is reduced by 1°C/125 m (1.8°F/410 Ft) above 900 m (2953 Ft)	

Table 28. Common Environmental Specifications for ASHRAE A2, A3 and A4

Temperature	Specifications
Allowable continuous operations	
Maximum temperature gradient (applies to both operation and non-operation)	20°C in an hour* (36°F in an hour) and 5°C in 15 minutes (9°F in 15 minutes), 5°C in an hour* (9°F in an hour) for tape hardware <i>i</i> NOTE: * - Per ASHRAE thermal guidelines for tape hardware, these are not instantaneous rates of temperature change.
Non-operational temperature limits	-40 to 65°C (-40 to 149°F)
Non-operational humidity limits	5% to 95% RH with 27°C (80.6°F) maximum dew point
Maximum non-operational altitude	12,000 meters (39,370 feet)
Maximum operational altitude	3,048 meters (10,000 feet)

Table 29. Maximum vibration specifications

Maximum vibration	Specifications
Operating	0.21 G _{rms} at 5 Hz to 500 Hz for 10 minutes (all operation orientations)
Storage	1.88 G _{rms} at 10 Hz to 500 Hz for 15 minutes (all six sides tested)

Table 30. Maximum shock pulse specifications

Maximum shock pulse	Specifications
Operating	Six consecutively executed shock pulses in the positive and negative x, y, and z axis of 6 G for up to 11 ms
Storage	Six consecutively executed shock pulses in the positive and negative x, y, and z axis (one pulse on each side of the system) of 71 G for up to 2 ms

Particulate and gaseous contamination specifications

The following table defines the limitations that help avoid any equipment damage or failure from particulates and gaseous contamination. If the levels of particulates or gaseous pollution exceed the specified limitations and result in equipment damage or failure, you may need to rectify the environmental conditions. Remediation of environmental conditions is the responsibility of the customer.

Table 31. Particulate contamination specifications

Particulate contamination	Specifications
Air filtration	Data center air filtration as defined by ISO Class 8 per ISO 14644-1 with a 95% upper confidence limit <i>i</i> NOTE: This condition applies to data center environments only. Air filtration requirements do not apply to IT equipment designed to be used outside a data center, in environments such as an office or factory floor. <i>i</i> NOTE: Air entering the data center must have MERV11 or MERV13 filtration.
Conductive dust	Air must be free of conductive dust, zinc whiskers, or other conductive particles <i>i</i> NOTE: This condition applies to data center and non-data center environments.
Corrosive dust	<ul style="list-style-type: none"> • Air must be free of corrosive dust • Residual dust present in the air must have a deliquescent point less than 60% relative humidity <i>i</i> NOTE: This condition applies to data center and non-data center environments.

Table 32. Gaseous contamination specifications

Gaseous contamination	Specifications
Copper coupon corrosion rate	<300 Å/month per Class G1 as defined by ANSI/ISA71.04-2013
Silver coupon corrosion rate	<200 Å/month as defined by ANSI/ISA71.04-2013

Thermal air restrictions

ASHRAE A3 environment

- Two PSUs are required in redundant mode, however single PSU failure is not supported.
- PCIe SSD is not supported.
- DIMMs greater than 32 GB are not supported.
- Both SW and DW GPGPU/FPGA are not supported.
- CPU TDP greater than 200W are not supported.
- Rear drives are not supported.
- PCIe card TDP more than 25 W is not supported.
- OCP is supported with 85C active optic cable.

ASHRAE A4 environment

- Two PSUs are required in redundant mode, however single PSU failure is not supported.
- PCIe SSD is not supported.
- DIMMs greater than 32 GB are not supported.
- Both SW and DW GPGPU/FPGA are not supported.
- CPU TDP greater than 200W are not supported.
- Rear drives are not supported.
- PCIe card TDP more than 25 W is not supported.
- OCP is supported with 85C active cable and cards Tier<=4
- BOSS N1 is not supported.

Liquid cooling: ASHRAE A3 environment

- Two PSUs are required in redundant mode, however single PSU failure is not supported.
- PCIe SSD is not supported.
- DIMMs greater than 32 GB are not supported.
- Both SW and DW GPGPU/FPGA are not supported.
- Rear drives are not supported.
- PCIe card TDP more than 25 W is not supported.
- OCP is supported with 85C active optic cable.

Liquid cooling: ASHRAE A4 environment

- Two PSUs are required in redundant mode, however single PSU failure is not supported.
- PCIe SSD is not supported.
- DIMMs greater than 32 GB are not supported.
- Both SW and DW GPGPU/FPGA are not supported.
- Rear drives are not supported.
- PCIe card TDP more than 25 W is not supported.
- OCP is supported with 85C active cable and cards Tier<=5
- BOSS N1 is not supported.

Other Restrictions

High temp spec(85C) active optics cable is required for cards,

- 25Gb and above PCIe/OCP cards require DAC or 85C active optics cable.

Thermal restriction matrix

Table 33. Air cooling: Thermal restriction matrix(non-GPU)

Configuration		No BP	8 x 2.5" U.2	16 x 2.5" SAS (SmartFlow)	16 x 2.5" U.2 (SmartFlow)	24 x 2.5" SAS			16x2.5" SAS + 8x2.5" U.2	8x3.5"	12x3.5"			
Rear storage		No Rear Drives	No Rear Drives	No Rear Drives	No Rear Drives	No Rear Drives	2x Rear 2.5" w/ 2x Rear-Fan	4x Rear 2.5" w/ 3x Rear-Fan	No Rear Drives	No Rear Drives	No Rear Drives	2x Rear 2.5" w/ 2x Rear-Fan	4x Rear 2.5" w/ 3x Rear-Fan	
CPU cTDP Max	CPU TDP													
CPU TDP / cTDP	240W	210W	HPR SILVER Fan + 2U STD HSK								HPR SILVER Fan [75%] + 2U STD HSK	HPR GOLD Fan [70%] + 2U EXT HSK		
		200W												
	300W	290W	HPR SILVER Fan + 2U EXT HSK								HPR SILVER Fan [75%]	HPR GOLD Fan [70%] + 2U EXT HSK		
		280W										(Note 1)		

Table 33. Air cooling: Thermal restriction matrix(non-GPU) (continued)

Configuration		No BP	8 x 2.5" U.2	16 x 2.5" SAS (SmartFlow)	16 x 2.5" U.2 (SmartFlow)	24 x 2.5" SAS		16x2.5" SAS + 8x2.5" U.2	8x3.5"	12x3.5"			
Rear storage		No Rear Drives	No Rear Drives	No Rear Drives	No Rear Drives	No Rear Drives	2x Rear 2.5" w/ 2x Rear-Fan	4x Rear 2.5" w/ 3x Rear-Fan	No Rear Drives	No Rear Drives	No Rear Drives	2x Rear 2.5" w/ 2x Rear-Fan	4x Rear 2.5" w/ 3x Rear-Fan
CPU cTDP Max	CPU TDP												
										+ 2U EXT HSK			
400 W	360 W	HPR SILVER Fan				HPR GOLD Fan			HPR GOLD Fan [75%]	Requires LC			
	320 W												
	340 W	+ 2U EXT HSK				+ 2U EXT HSK			+ 2U EXT HSK				
Memory	16GB RDIMM	HPR SILVER Fan				HPR GOLD Fan			HPR SILVER Fan [75%]	HPR GOLD Fan [70%]			
	32GB RDIMM												
	64GB RDIMM												
	128GB RDIMM	HPR GOLD Fan		Not supported		Not supported							
	256GB RDIMM (Note 2)	HPR GOLD Fan		HPR GOLD Fan (Note 1)									

Note 1: Supported ambient temperature is 30°C.

Note 2: Support SKHYNIX RDIMM only

Table 34. Air cooling: Thermal restriction matrix(GPU Configuration)

Configuration			No BP	8 x 2.5" U.2	16 x 2.5" SAS (SmartFlow)	16 x 2.5" U.2 (SmartFlow)	24 x 2.5" SAS	16x2.5" SAS + 8x2.5" U.2	8x3.5"
Rear storage			No Rear Drives						
CPU cTDP Max	CPU TDP	Model							
CPU TDP/ cTDP	240 W	210 W	9334	HPR GOLD Fan					HPR GOLD Fan [75%] + 1U EXT HSK
		200 W	9254						
			9224						
			9124						
300 W	290 W	9634							
	280 W	9534							
	290 W	9454							
	280 W	9354							

Table 34. Air cooling: Thermal restriction matrix(GPU Configuration) (continued)

Configuration				No BP	8 x 2.5" U.2	16 x 2.5" SAS (SmartFlow)	16 x 2.5" U.2 (SmartFlow)	24 x 2.5" SAS	16x2.5" SAS + 8x2.5" U.2	8x3.5"
Rear storage				No Rear Drives						
CPU cTDP Max	CPU TDP	Model		No Rear Drives						
	400 W	360 W	9654	HPR GOLD Fan + 1U EXT HSK		Not Supported				Requires LC
			9554	HPR GOLD Fan						
		9474F	+ 1U EXT HSK (Note 1)							
		9374F								
	320 W	9274F	HPR GOLD Fan							
		9174F	+ 1U EXT HSK							
	400 W (Note 2)	340 W	9734	HPR GOLD Fan						
		360 W	9754	HPR GOLD Fan + 1U EXT HSK (Note 1)						
Memory	16GB RDIMM		HPR GOLD Fan						HPR GOLD Fan [75%]	
	32GB RDIMM									
	64GB RDIMM									
	128GB RDIMM		HPR GOLD Fan	Not Supported	Not Supported					
	256GB RDIMM (Note 3)			HPR GOLD Fan (Note 1)						
GPU	A2		HPR GOLD Fan						HPR GOLD Fan [75%] (Note 1)	
	A16 64GB									
	A30 24GB									
	A40 48GB									
	A100 80GB									
	MI210 64GB								HPR GOLD Fan [75%]	

Note 1: Supported ambient temperature is 30°C.

Note 2: Bergamo CPUs.

Note 3: Support SKHYNIX RDIMM only

i NOTE: “High-Performance GOLD Fan” to be supported on all GPU configs.

i NOTE: GPU is not supported on 12x3.5-inch configs and system configs with rear module installed.

Table 35. Air Cooling: Thermal Guidance(non GPU)

Configuration			No BP	8 x 2.5" U.2	16 x 2.5" SAS (SmartFlow)	16 x 2.5" U.2 (SmartFlow)	24 x 2.5" SAS		16x2.5" SAS + 8x2.5" U.2	8x3.5"	12x3.5"			
Rear storage			No Rear Drives	No Rear Drives	No Rear Drives	No Rear Drives	No Rear Drives	2x Rear 2.5" w/ 2x Rear-Fan	4x Rear 2.5" w/ 3x Rear-Fan	No Rear Drives	No Rear Drives	No Rear Drives	2x Rear 2.5" w/ 2x Rear-Fan	4x Rear 2.5" w/ 3x Rear-Fan
CPU cTDP Max	Model	Core Count #	No Rear Drives	No Rear Drives	No Rear Drives	No Rear Drives	No Rear Drives	2x Rear 2.5" w/ 2x Rear-Fan	4x Rear 2.5" w/ 3x Rear-Fan	No Rear Drives	No Rear Drives	No Rear Drives	2x Rear 2.5" w/ 2x Rear-Fan	4x Rear 2.5" w/ 3x Rear-Fan
CPU TDP / cTDP	240 W	9334	32	35°C							35°C	35°C		
		9254	24											
		9224	24											
		9124	16											
	300 W	9634	84	35°C							35°C	30°C		
		9534	64											
		9454	48											
		9354	32											
	400 W	9654	96	35°C							35°C	Requires LC		
		9554	64											
		9474F	48											
		9374F	32											
		9274F	24											
		9174F	16											
		9734	112											
Memory	16GB RDIMM		35°C							35°C	35°C			
	32GB RDIMM													
	64GB RDIMM													
	128GB RDIMM		35°C	Not Supported		Not Supported								
	256GB RDIMM (Note 1)			30°C										

Note 1: Support SKHYNIX RDIMM only

(i) NOTE: Not all backplanes/risers support liquid cooling; these are listed as "No Support".

(i) NOTE: Inlet temperature determined by lowest degree requirement.

Table 36. Air Cooling: Thermal Guidance (GPU Configuration)

Configuration			No BP	8 x 2.5" U.2	16 x 2.5" SAS (SmartFlow)	16 x 2.5" U.2 (SmartFlow)	24 x 2.5" SAS	16x2.5" SAS + 8x2.5" U.2	8x3.5"	
Rear storage			No Rear Drives							
CPU cTDP Max	Model	Core Count#								
CPU TDP/ cTDP	240W	9334	32	35°C					35°C	
		9254	24							
		9224	24							
		9124	16							
	300 W	9634	84	35°C					35°C	
		9534	64							
		9454	48							
		9354	32							
	400 W	9654	96	35°C	Not Supported					Requires LC
		9554	64	30°C						
		9474F	48							
		9374F	32							
		9274F	24	35°C						
		9174F	16							
9734		112								
9754		128	30°C							
Memory	16GB RDIMM		35°C					35°C		
	32GB RDIMM									
	64GB RDIMM									
	128GB RDIMM		35°C	Not Supported	Not Supported			Not Supported		
	256GB RDIMM (Note 1)			30°C						
GPU	A2		35°C					30°C		
	A16 64GB							35°C		
	A30 24GB									
	A40 48GB									
	A100 80GB									
	MI210 64GB									

Note 1: Support SKHYNIX RDIMM only

NOTE: Not all backplanes/risers support liquid cooling; these are listed as "No Support".

NOTE: Inlet temperature determined by lowest degree requirement.

Table 37. Liquid cooling: Thermal restriction matrix(non-GPU)

Configuration		No BP	8 x 2.5" U.2	24 x 2.5" SAS		8x3.5"	12x3.5"			
Rear storage		No Rear Drives	No Rear Drives	2x Rear 2.5" w/ 2x Rear-Fan	4x Rear 2.5" w/ 3x Rear-Fan	No Rear Drives	No Rear Drives	2x Rear 2.5" w/ 2x Rear-Fan	4x Rear 2.5" w/ 3x Rear-Fan	
CPU	All CPU TDP SKUs	HPR SILVER Fan				HPR SILVER Fan [75%]	HPR GOLD Fan [70%]			
Memory	16GB RDIMM	HPR SILVER Fan				HPR SILVER Fan [75%]	HPR GOLD Fan [70%]			
	32GB RDIMM									
	64GB RDIMM									
	128GB RDIMM	HPR GOLD Fan		Not supported						
	256GB RDIMM (Note 1)									

Note 1: Support SKHYNIX RDIMM only

Note: Use “High-Performance Silver” fan for all 2.5” and 8x3.5” configs.

Note: Use “High-Performance GOLD” fan for all 12x3.5” configs.

Table 38. Liquid cooling: Thermal restriction matrix(GPU Configuration)

Configuration		No BP	8 x 2.5" U.2	8x3.5"
Rear storage		No Rear Drives	No Rear Drives	No Rear Drives
CPU	All CPU TDP SKUs	HPR GOLD Fan		HPR GOLD Fan [75%]
Memory	16GB RDIMM	HPR GOLD Fan		HPR GOLD Fan [75%]
	32GB RDIMM			
	64GB RDIMM			
	128GB RDIMM	HPR GOLD Fan		Not supported
	256GB RDIMM (Note 2)			
GPU	A2	HPR GOLD Fan		HPR GOLD Fan [75%] Note 1
	A16 64GB			
	A30 24GB			
	A40 48GB			
	A100 80GB			
	MI210 64GB			HPR GOLD Fan [75%]

Note 1: Supported ambient temperature is 30°C.

Note 2: Support SKHYNIX RDIMM only

Note: “High-Performance GOLD Fan” to be supported on all GPU configs.

Note: GPU is not supported on 12x3.5” configs and system configs with rear module installed.

Table 39. Label reference

Label	Description
HPR SILVER (Silver)	High performance (silver grade)
HPR GOLD (Gold)	High performance (gold grade)
HSK	Heat sink
LP	Low profile
FH	Full height

Initial system setup and configuration

This section describes the tasks for initial setup and configuration of the Dell system. The section also provides general steps to set up the system and the reference guides for detailed information.

Topics:

- [Setting up the system](#)
- [iDRAC configuration](#)
- [Resources to install operating system](#)

Setting up the system

Perform the following steps to set up the system:

Steps

1. Unpack the system.
2. Install the system into the rack. For more information, see the rail installation and cable management accessory guides relevant to your rail and cable management solution at www.dell.com/poweredgemanuals.
3. Connect the peripherals to the system and the system to the electrical outlet.
4. Power on the system.

For more information about setting up the system, see the *Getting Started Guide* that is shipped with your system.

 **NOTE:** For information about managing the basic settings and features of the system, see the [Pre-operating system management applications](#) chapter.

iDRAC configuration

The Integrated Dell Remote Access Controller (iDRAC) is designed to make you more productive as a system administrator and improve the overall availability of Dell servers. iDRAC alerts you to system issues, helps you to perform remote management, and reduces the need for physical access to the system.

Options to set up iDRAC IP address

To enable communication between your system and iDRAC, you must first configure the network settings based on your network infrastructure. The network settings option is set to **DHCP**, by default.



 **NOTE:** For static IP configuration, you must request for the settings at the time of purchase.

You can set up the iDRAC IP address using one of the interfaces in the table below. For information about setting up iDRAC IP address, see the documentation links provided in the table below.

Table 40. Interfaces to set up iDRAC IP address

Interface	Documentation links
iDRAC Settings utility	<i>Integrated Dell Remote Access Controller User's Guide</i> at https://www.dell.com/idracmanuals or for system specific <i>Integrated Dell Remote Access Controller User's Guide</i> , go to https://www.dell.com/poweredgemanuals > Product Support page of your system > Documentation .

Table 40. Interfaces to set up iDRAC IP address (continued)

Interface	Documentation links
	<p> NOTE: To determine the most recent iDRAC release for your platform and for latest documentation version, see KB article https://www.dell.com/support/article/sln308699.</p>
iDRAC Direct	<p><i>Integrated Dell Remote Access Controller User's Guide</i> at https://www.dell.com/idracmanuals or for system specific <i>Integrated Dell Remote Access Controller User's Guide</i>, go to https://www.dell.com/poweredgemanuals > Product Support page of your system > Documentation.</p> <p> NOTE: To determine the most recent iDRAC release for your platform and for latest documentation version, see KB article https://www.dell.com/support/article/sln308699.</p>
Lifecycle Controller	<p><i>Dell Lifecycle Controller User's Guide</i> at https://www.dell.com/idracmanuals or for system specific <i>Dell Lifecycle Controller User's Guide</i>, go to https://www.dell.com/poweredgemanuals > Product Support page of your system > Documentation.</p> <p> NOTE: To determine the most recent iDRAC release for your platform and for latest documentation version, see KB article https://www.dell.com/support/article/sln308699.</p>

 **NOTE:** To access iDRAC, ensure that you connect the ethernet cable to the iDRAC dedicated network port or use the iDRAC Direct port by using the micro USB (type AB) cable. You can also access iDRAC through the shared LOM mode, if you have opted for a system that has the shared LOM mode enabled.

Options to log in to iDRAC

To log in to the iDRAC Web User Interface, open a browser and enter the IP address.

You can log in to iDRAC as:

- iDRAC user
- Microsoft Active Directory user
- Lightweight Directory Access Protocol (LDAP) user

In the login screen displayed, if you have opted for secure default access to iDRAC, the default username is `root` and enter the iDRAC secure default password available on back of the Information Tag. If you opted for legacy password, use the iDRAC legacy username and password - `root` and `calvin`, the iDRAC default password will be blank on the information tag. Then you will be prompted and required to create a password of your choice before proceeding. You can also log in by using your Single Sign-On or Smart Card.

 **NOTE:** Ensure that you change the default username and password after setting up the iDRAC IP address.

For more information about logging in to the iDRAC and iDRAC licenses, see the latest *Integrated Dell Remote Access Controller User's Guide* at www.dell.com/idracmanuals.

 **NOTE:** To determine the most recent iDRAC release for your platform and for latest documentation version, see KB article <https://www.dell.com/support/article/sln308699>.

You can also access iDRAC using command-line protocol - RACADM. For more information, see the *Integrated Dell Remote Access Controller RACADM CLI Guide* available at <https://www.dell.com/idracmanuals>.

You can also access iDRAC using automation tool - Redfish API. For more information, see the *Integrated Dell Remote Access Controller User's Guide Redfish API Guide* available at <https://developer.dell.com>.

Resources to install operating system

If the system is shipped without an operating system, you can install a supported operating system by using one of the resources provided in the table below. For information about how to install the operating system, see the documentation links provided in the table below.

Table 41. Resources to install the operating system

Resource	Documentation links
iDRAC	<i>Integrated Dell Remote Access Controller User's Guide</i> at https://www.dell.com/idracmanuals or for system specific <i>Integrated Dell Remote Access Controller User's Guide</i> , go to https://www.dell.com/poweredgemanuals > Product Support page of your system > Documentation . ⓘ NOTE: To determine the most recent iDRAC release for your platform and for latest documentation version, see KB article at https://www.dell.com/support/article/sln308699 .
Lifecycle Controller	<i>Dell Lifecycle Controller User's Guide</i> at https://www.dell.com/idracmanuals or for system specific <i>Dell Lifecycle Controller User's Guide</i> , go to https://www.dell.com/poweredgemanuals > Product Support page of your system > Documentation . Dell recommends using Lifecycle Controller to install the OS, since all required drivers are installed on the system. ⓘ NOTE: To determine the most recent iDRAC release for your platform and for latest documentation version, see KB article at https://www.dell.com/support/article/sln308699 .
OpenManage Deployment Toolkit	www.dell.com/openmanagemanuals > OpenManage Deployment Toolkit
Dell certified VMware ESXi	www.dell.com/virtualizationsolutions

ⓘ **NOTE:** For more information about installation and how-to videos for operating systems supported on PowerEdge systems, see [Supported Operating Systems for Dell PowerEdge systems](#).

Options to download drivers and firmware

You can download firmware from the Dell support site. For information about downloading firmware, see the [Downloading drivers and firmware](#) section.

You can also choose any one of the following options to download the firmware. For information about how to download the firmware, see the documentation links provided in the table below.

Table 42. Options to download firmware

Option	Documentation link
Using Integrated Dell Remote Access Controller Lifecycle Controller (iDRAC with LC)	www.dell.com/idracmanuals
Using Dell Repository Manager (DRM)	www.dell.com/openmanagemanuals > Repository Manager
Using Dell Server Update Utility (SUU)	www.dell.com/openmanagemanuals > Server Update Utility
Using Dell OpenManage Deployment Toolkit (DTK)	www.dell.com/openmanagemanuals > OpenManage Deployment Toolkit
Using iDRAC virtual media	www.dell.com/idracmanuals

Options to download and install OS drivers

You can choose any one of the following options to download and install OS drivers. For information about how to download or install OS drivers, see the documentation links provided in the table below.

Table 43. Options to download and install OS drivers

Option	Documentation
Dell support site	Downloading drivers and firmware section.
iDRAC virtual media	<i>Integrated Dell Remote Access Controller User's Guide</i> at https://www.dell.com/idracmanuals or for system specific <i>Integrated Dell Remote Access Controller User's Guide</i> , go to https://www.dell.com/poweredgemanuals > Product Support page of your system > Documentation .  NOTE: To determine the most recent iDRAC release for your platform and for latest documentation version, see https://www.dell.com/support/article/sln308699 .

Downloading drivers and firmware

It is recommended that you download and install the latest BIOS, drivers, and systems management firmware on the system.

Prerequisites

Ensure that you clear the web browser cache before downloading the drivers and firmware.

Steps

1. Go to www.dell.com/support/drivers.
2. Enter the Service Tag of the system in the **Enter a Dell Service Tag, Dell Product ID or Model** field, and then press Enter.
 **NOTE:** If you do not have the Service Tag, click **Browse all products**, and navigate to your product.
3. On the displayed product page, click **Drivers & Downloads**.
On the **Drivers & Downloads** page, all drivers that are applicable to the system are displayed.
4. Download the drivers to a USB drive, CD, or DVD.

Pre-operating system management applications

You can manage basic settings and features of a system without booting to the operating system by using the system firmware.

Options to manage the pre-operating system applications

You can use any one of the following options to manage the pre-operating system applications:

- System Setup
- Dell Lifecycle Controller
- Boot Manager
- Preboot Execution Environment (PXE)

Topics:

- [System Setup](#)
- [Dell Lifecycle Controller](#)
- [Boot Manager](#)
- [PXE boot](#)

System Setup

Using the **System Setup** option, you can configure the BIOS settings, iDRAC settings, and device settings of the system.

You can access system setup by using any one of the following interfaces:

- Graphical User interface — To access go to iDRAC Dashboard, click **Configuration**, and click **BIOS Settings**.
- Text browser — The browser is enabled by using Console Redirection.

To view **System Setup**, power on the system, press F2, and click **System Setup Main Menu**.

 **NOTE:** If the operating system begins to load before you press F2, wait for the system to finish booting, and then restart the system and try again.

The **System Setup Main Menu** screen details are described as follows:

Table 44. System Setup Main Menu

Option	Description
System BIOS	Enables you to configure the BIOS settings.
iDRAC Settings	Enables you to configure the iDRAC settings. The iDRAC settings utility is an interface to set up and configure the iDRAC parameters by using UEFI (Unified Extensible Firmware Interface). You can enable or disable various iDRAC parameters by using the iDRAC settings utility. For more information about this utility, see <i>Integrated Dell Remote Access Controller User's Guide</i> at www.dell.com/poweredgemanuals .
Device Settings	Enabled you to configure device settings for devices such as storage controllers or network cards.

System BIOS

To view the **System BIOS** screen, power on the system, press F2, and click **System Setup Main Menu > System BIOS**.

Table 45. System BIOS details

Option	Description
System Information	Provides information about the system such as the system model name, BIOS version, and Service Tag.
Memory Settings	Specifies information and options related to the installed memory.
Processor Settings	Specifies information and options related to the processor such as speed and cache size.
SATA Settings	Specifies options to enable or disable the integrated SATA controller and ports.
NVMe Settings	Specifies options to change the NVMe settings. If the system contains the NVMe drives that you want to configure in a RAID array, you must set both this field and the Embedded SATA field on the SATA Settings menu to RAID mode. You might also need to change the Boot Mode setting to UEFI . Otherwise, you should set this field to Non-RAID mode.
Boot Settings	Specifies options to specify the Boot mode (BIOS or UEFI). Enables you to modify UEFI and BIOS boot settings.
Network Settings	Specifies options to manage the UEFI network settings and boot protocols. Legacy network settings are managed from the Device Settings menu.  NOTE: Network Settings are not supported in BIOS boot mode.
Integrated Devices	Specifies options to manage integrated device controllers and ports, specifies related features, and options.
Serial Communication	Specifies options to manage the serial ports, its related features, and options.
System Profile Settings	Specifies options to change the processor power management settings, memory frequency.
System Security	Specifies options to configure the system security settings, such as system password, setup password, Trusted Platform Module (TPM) security, and UEFI secure boot. It also manages the power button on the system
Redundant OS Control	Sets the redundant OS information for redundant OS control.
Miscellaneous Settings	Specifies options to change the system date and time.

System Information

To view the **System Information** screen, power on the system, press F2, and click **System Setup Main Menu > System BIOS > System Information**.

Table 46. System Information details

Option	Description
System Model Name	Specifies the system model name.
System BIOS Version	Specifies the BIOS version installed on the system.
System Service Tag	Specifies the system Service Tag.
System Manufacturer	Specifies the name of the system manufacturer.
System Manufacturer Contact Information	Specifies the contact information of the system manufacturer.

Table 46. System Information details (continued)

Option	Description
System CPLD Version	Specifies the current version of the system complex programmable logic device (CPLD) firmware.
UEFI Compliance Version	Specifies the UEFI compliance level of the system firmware.
AGESA Version	Specifies the AGESA reference code version.
SMU Version	Specifies the SMU firmware version.
MPIO Version	Specifies the MPIO firmware version.

Memory Settings

To view the **Memory Settings** screen, power on the system, press F2, and click **System Setup Main Menu > System BIOS > Memory Settings**.

Table 47. Memory Settings details

Option	Description
System Memory Size	Specifies the memory size in the system.
System Memory Type	Specifies the type of memory installed in the system.
System Memory Speed	Specifies the system memory speed.
Video Memory	Specifies the amount of video memory.
System Memory Testing	Specifies whether the system memory tests are run during system boot. The two options available are Enabled and Disabled . This option is set to Disabled by default.
DRAM Refresh Delay	By enabling the CPU memory controller to delay running the REFRESH commands, you can improve the performance for some workloads. By minimizing the delay time, it is ensured that the memory controller runs the REFRESH command at regular intervals. For Intel-based servers, this setting only affects systems configured with DIMMs which use 8 Gb density DRAMs. This option is set to Minimum by default.
DIMM Self Healing(Post Package Repair) on Uncorrectable Memory Error	Enables or disables Post Package Repair (PPR) on Uncorrectable Memory Error. This option is set to Enabled by default.
Correctable Error Logging	Enables or disables correctable error logging. This option is set to Disabled by default.

Processor Settings

To view the **Processor Settings** screen, power on the system, press F2, and click **System Setup Main Menu > System BIOS > Processor Settings**.

Table 48. Processor Settings details

Option	Description
Logical Processor	Each processor core supports up to two logical processors. If this option is set to Enabled , the BIOS displays all the logical processors. If this option is set to Disabled , the BIOS displays only one logical processor per core. This option is set to Enabled by default.
Virtualization Technology	Enables or disables the virtualization technology for the processor. This option is set to Enabled by default.

Table 48. Processor Settings details (continued)

Option	Description
IOMMU Support	Enable or Disable IOMMU support. It is required to create IVRS ACPI table. This option is set to Enabled by default.
Kernel DMA Protection	When this option is set to Enabled, using IOMMU, BIOS, and the Operating System will enable direct memory access protection for DMA capable peripheral devices. Enable IOMMU Support to use this option. This option is set to Disabled by default. When set to Enabled by using Virtualization Technology, BIOS and Operating System will enable direct memory access protection for DMA capable peripheral devices. Enable Virtualization Technology to use this option.
L1 Stream HW Prefetcher	Enables or disables the L1 stream hardware prefetcher. This option is set to Enabled by default.
L2 Stream HW Prefetcher	Enables or disables the L2 stream hardware prefetcher. This option is set to Enabled by default.
L1 Stride Prefetcher	Enables or disables the L1 stride prefetcher. This option is set to Enabled by default, as it optimizes overall workload. i NOTE: This option is only available for 3rd Generation AMD EPYC processors.
L1 Region Prefetcher	Enables or disables the L1 region prefetcher. This option is set to Enabled by default, as it optimizes overall workload. i NOTE: This option is only available for 3rd Generation AMD EPYC processors.
L2 Up Down Prefetcher	Enables or disables the L2 up down prefetcher. This option is set to Enabled by default, as it optimizes overall workload. i NOTE: This option is only available for 3rd Generation AMD EPYC processors.
MADT Core Enumeration	Specifies the MADT Core Enumeration. This option is set to Linear by default.
NUMA Nodes Per Socket	Specifies the number of NUMA nodes per socket. This option is set to 1 by default.
L3 cache as NUMA Domain	Enables or disables the L3 cache as NUMA Domain. This option is set to Disabled by default.
Secure Memory Encryption	Enables or disables the AMD secure encryption features such as SME and Secure Encrypted Virtualization (SEV) . It also determines if other secure encryption features such as TSME and SEV-SNP can be enabled. This option is set to Disabled by default. i NOTE: This option is only available for 3rd Generation AMD EPYC processors.
Minimum SEV non-ES ASID	Determines the number of Secure Encrypted Virtualization ES and non-ES available Address Space IDs. This option is set to 1 by default.
Transparent Secure Memory Encryption	Enables or disables the TSME . TSME is always-on memory encryption that does not require OS or hypervisor support. This option is set to Disabled by default. <ul style="list-style-type: none"> ● If the OS supports SME, do not enable this field. ● If the hypervisor supports SEV, do not enable this field. Enabling TSME affects the system memory performance.

Table 48. Processor Settings details (continued)

Option	Description
Configurable TDP	Allows the reconfiguration of the processor Thermal Design Power (TDP) levels based on the power and thermal delivery capabilities of the system. TDP refers to the maximum amount of power the cooling system is required to dissipate. This option is set to Maximum by default. i NOTE: This option is only available on certain SKUs of the processors, and the number of alternative levels varies as well.
x2APIC Mode	Enables or disables x2APIC mode. This option is set to Enabled by default. i NOTE: For two CPU 64 cores configuration, x2APIC mode is not switchable if 256 threads are enabled (BIOS settings: All CCD, cores, and logical processors enabled).
Number of CCDs per Processor	Controls the number of enabled CCDs in each processor. This option is set to All by default.
Number of Cores per CCD	Specifies the number of cores per CCD. This option is set to All by default.
Processor Core Speed	Specifies the maximum core frequency of the processor.
Processor Bus Speed	Displays the bus speed of the processor(s).
Processor n	i NOTE: Depending on the number of CPUs, there might be up to n processors listed. The following settings are displayed for each processor that is installed in the system:

Table 49. Processor n details

Option	Description
Family-Model-Stepping	Specifies the family, model, and stepping of the processor as defined by AMD.
Brand	Specifies the brand name.
Level 2 Cache	Specifies the total L2 cache.
Level 3 Cache	Specifies the total L3 cache.
Number of Cores	Specifies the number of cores per processor.
Microcode	Specifies the processor microcode version.

SATA Settings

To view the **SATA Settings** screen, power on the system, press F2, and click **System Setup Main Menu > System BIOS > SATA Settings**.

Table 50. SATA Settings details

Option	Description
Embedded SATA	Enables the embedded SATA option to be set to Off , AHCI mode , or RAID modes . This option is set to AHCI Mode by default. i NOTE: 1. You might also need to change the Boot Mode setting to UEFI. Otherwise, you should set the field to Non-RAID mode.

Table 50. SATA Settings details (continued)

Option	Description
	2. No ESXi and Ubuntu OS support under RAID mode.
Security Freeze Lock	Sends Security Freeze Lock command to the embedded SATA drives during POST. This option is applicable only for AHCI Mode. This option is set to Enabled by default.
Write Cache	Enables or disables the command for the embedded SATA drives during POST. This option is set to Disabled by default.

NVMe Settings

To view the **NVMe Settings** screen, power on the system, press F2, and click **System Setup Main Menu > System BIOS > NVMe Settings**

Table 51. NVMe Settings details

Option	Description
NVMe Mode	This option sets the NVMe drive mode. If the system contains NVMe drives that you want to configure in a RAID array, you must set both this field and the Embedded SATA field on the SATA settings menu to RAID Mode. You may also need to change the Boot Mode setting to UEFI. The option is set to Non-RAID mode by default.
BIOS NVMe Driver	Dell Qualified NVMe drives always use the UEFI NVMe driver built into the Dell BIOS. When this option is set to 'All Drives', the BIOS driver will also be used with any NVMe drives in the system that has not been qualified by Dell. The option is set to Dell Qualified Drives by default. <i>i</i> NOTE: When this option is set to 'All Drives' and non-Dell qualified NVMe drives are present, you have a configuration that has not been validated which may lead to unexpected behavior.

Boot Settings

You can use the **Boot Settings** screen to set the boot mode to either **BIOS** or **UEFI**. It also enables you to specify the boot order.

- **UEFI:** The Unified Extensible Firmware Interface (UEFI) is a new interface between operating systems and platform firmware. The interface consists of data tables with platform related information, boot and runtime service calls that are available to the operating system and its loader. The following benefits are available when the **Boot Mode** is set to **UEFI**:
 - Support for drive partitions larger than 2 TB.
 - Enhanced security (e.g., UEFI Secure Boot).
 - Faster boot time.

i **NOTE:** You must use only the UEFI boot mode in order to boot from NVMe drives.

- **BIOS:** The **BIOS Boot Mode** is the legacy boot mode. It is maintained for backward compatibility.

To view the **Boot Settings** screen, power on the system, press F2, and click **System Setup Main Menu > System BIOS > Boot Settings**.

Table 52. Boot Settings details



Option	Description
Boot Mode	Enables you to set the boot mode of the system. If the operating system supports UEFI, you can set this option to UEFI. Setting this field to BIOS allows compatibility with non-UEFI operating systems. This option is set to UEFI by default.  CAUTION: Switching the boot mode may prevent the system from booting if the operating system is not installed in the same boot mode. <i>i</i> NOTE: Setting this field to UEFI disables the BIOS Boot Settings menu.

Table 52. Boot Settings details (continued)

Option	Description						
Boot Sequence Retry	Enables or disables the Boot Sequence Retry feature. If this option is set to Enabled and the system fails to boot, the system re-attempts the boot sequence after 30 seconds. This option is set to Enabled by default.						
Hard Disk Failover	Enables or disables the Hard-disk failover. This option is set to Disabled by default.						
Generic USB Boot	Enables or disables the generic USB boot placeholder. This option is set to Disabled by default.						
Hard-disk Drive Placeholder	Enables or disables the Hard-disk drive placeholder. This option is set to Disabled by default.						
Clean all SysPrep variables and order	When set to None , BIOS will do nothing. When set to Yes , BIOS will delete variables of SysPrep #### and SysPrepOrder this option is a onetime option, will reset to none when deleting variables. This setting is only available in UEFI Boot Mode . This option is set to None by default.						
UEFI Boot Settings	<p>Specifies the UEFI boot sequence. Enables or disables UEFI Boot options.</p> <p> NOTE: This option controls the UEFI boot order. The first option in the list will be attempted first.</p> <p>Table 53. UEFI Boot Settings</p> <table border="1"> <thead> <tr> <th>Option</th> <th>Description</th> </tr> </thead> <tbody> <tr> <td>UEFI Boot Sequence</td> <td>Enables you to change the boot device order.</td> </tr> <tr> <td>Boot Option Enable/Disable</td> <td>Enables you to select the enabled or disabled boot devices</td> </tr> </tbody> </table>	Option	Description	UEFI Boot Sequence	Enables you to change the boot device order.	Boot Option Enable/Disable	Enables you to select the enabled or disabled boot devices
Option	Description						
UEFI Boot Sequence	Enables you to change the boot device order.						
Boot Option Enable/Disable	Enables you to select the enabled or disabled boot devices						

Choosing system boot mode

System Setup enables you to specify one of the following boot modes for installing your operating system:

- UEFI boot mode (the default), is an enhanced 64-bit boot interface. If you have configured your system to boot to UEFI mode, it replaces the system BIOS.
- From the **System Setup Main Menu**, click **Boot Settings**, and select **Boot Mode**.
 - Select the UEFI boot mode you want the system to boot into.
-  **CAUTION: Switching the boot mode may prevent the system from booting if the operating system is not installed in the same boot mode.**
- After the system boots in the specified boot mode, proceed to install your operating system from that mode.

 **NOTE:** Operating systems must be UEFI-compatible to be installed from the UEFI boot mode. DOS and 32-bit operating systems do not support UEFI and can only be installed from the BIOS boot mode.

 **NOTE:** For the latest information about supported operating systems, go to www.dell.com/ossupport.

Changing boot order

About this task

You may have to change the boot order if you want to boot from a USB key or an optical drive. The following instructions may vary if you have selected **BIOS** for **Boot Mode**.

 **NOTE:** Changing the drive boot sequence is only supported in BIOS boot mode.

Steps

- On the **System Setup Main Menu** screen, click **System BIOS > Boot Settings > UEFI Boot Settings > UEFI Boot Sequence**.

2. Use the arrow keys to select a boot device, and use the plus (+) and minus (-) sign keys to move the device down or up in the order.
3. Click **Exit**, and then click **Yes** to save the settings on exit.

 **NOTE:** You can also enable or disable boot order devices as needed.

Network Settings

To view the **Network Settings** screen, power on the system, press F2, and click **System Setup Main Menu > System BIOS > Network Settings**.

 **NOTE:** For information about Linux network performance settings, see the *Linux Network Tuning Guide for AMD EPYC Processor Based Servers* at [AMD.com](https://www.amd.com).

 **NOTE:** Network Settings are not supported in BIOS boot mode.

Table 54. Network Settings details

Option	Description
UEFI PXE Settings	Enables you to control the configuration of the UEFI PXE device.
Number of PXE Devices	Enables you to choose the number of PXE Devices from 1 to 4, 8, 12, 16.
PXE Device n (n = 1 to 16)	Enables or disables the device. When enabled, a UEFI PXE boot option is created for the device.
PXE Device n Settings (n = 1 to 16)	Enables you to control the configuration of the PXE device.
UEFI HTTP Settings	Enables you to control the configuration of the UEFI HTTP device.
HTTP Device n (n = 1 to 4)	Enables or disables the device. When enabled, a UEFI HTTP boot option is created for the device.
HTTP Device n Settings (n = 1 to 4)	Enables you to control the configuration of the HTTP device.
UEFI ISCSI Settings	Enables you to control the configuration of the ISCSI device.
UEFI NVMe-oF Settings	Enables you to control the configuration of the NVMe-oF device.

Table 55. PXE Device n Settings details

Option	Description
Interface	Specifies NIC interface used for the PXE device.
Protocol	Specifies Protocol used for PXE device. This option is set to IPv4 or IPv6 . This option is set to IPv4 by default.
VLAN	Enables VLAN for PXE device. This option is set to Enable or Disable . This option is set to Disable by default.
VLAN ID	Shows the VLAN ID for the PXE device
VLAN Priority	Shows the VLAN Priority for the PXE device.

Table 56. HTTP Device n Settings details

Option	Description
Interface	Specifies NIC interface used for the HTTP device.
Protocol	Specifies Protocol used for HTTP device. This option is set to IPv4 or IPv6 . This option is set to IPv4 by default. The following options will be available when Protocol is set as IPv6: Auto Configuration: IPv6 Auto Configuration Enable/Disabled for this HTTP Device. IPv6 Address: IPv6 Unicast address for this HTTP Device.

Table 56. HTTP Device n Settings details (continued)

Option	Description
	Prefix Length: IPv6 Prefix Length (0-128) for this HTTP Device.
VLAN	Enables VLAN for HTTP device. This option is set to Enable or Disable . This option is set to Disable by default.
VLAN ID	Shows the VLAN ID for the HTTP device
VLAN Priority	Shows the VLAN Priority for the HTTP device.
DHCP	Enables or disables DHCP for this HTTP device. This option is set to Enable by default.
IP Address	Specifies IP address for the HTTP device.
Subnet Mask	Specifies subnet mask for the HTTP device.
Gateway	Specifies gateway for the HTTP device.
DNS info via DHCP	Enables or disables DNS Information from DHCP. This option is set to Enable by default.
Primary DNS	Specifies the primary DNS server IP address for the HTTP Device.
Secondary DNS	Specifies the secondary DNS server IP address for the HTTP Device.
URI (will obtain from DHCP server if not specified)	The URI will be obtained from the DHCP server if not specified.
TLS Authentication Configuration	View and/or modify this device's boot TLS authentication configuration.

Table 57. UEFI ISCSI Settings screen details

Option	Description
ISCSI Initiator Name	Specifies the name of the ISCSI initiator in IQN format.
ISCSI Device1	Enables or disables the ISCSI device. When disabled, a UEFI boot option is created for the ISCSI device automatically. This is set to Disabled by default.
ISCSI Device1 Settings	Enables you to control the configuration of the ISCSI device.

Table 58. ISCSI Device1 Settings screen details

Option	Description
Connection 1	Enables or disables the ISCSI connection. This option is set to Disable by default.
Connection 2	Enables or disables the ISCSI connection. This option is set to Disable by default.
Connection 1 Settings	Enables you to control the configuration for the ISCSI connection.
Connection 2 Settings	Enables you to control the configuration for the ISCSI connection.
Connection Order	Enables you to control the order for which the ISCSI connections will be attempted.

Table 59. UEFI NVMe-oF Settings screen details

Option	Description
NVMe-oF	Enables or disables the NVMe-oF device. When disabled, a UEFI boot option is created for the NVMe-oF device automatically. This is set to Disabled by default.
NVMe-oF Host NQN	Specifies Host NQN of the NVMe-oF device.
NVMe-oF Host Id	Specifies Host Id of the NVMe-oF device.
Host Security Key Path	Specifies Host Security Key Path of the NVMe-oF device.
NVMe-oF SubSystem Settings	Enables you to control the configuration of the NVMe-oF device.

Integrated Devices

To view the **Integrated Devices** screen, power on the system, press F2, and click **System Setup Main Menu > System BIOS > Integrated Devices**.

Table 60. Integrated Devices details

Option	Description
User Accessible USB Ports	<p>Configures the user accessible USB ports. Selecting Only Back Ports On disables the front USB ports; selecting All Ports Off disables all front and back USB ports; selecting All Ports Off (Dynamic) disables all front and back USB ports during POST. This option is set to All Ports On by default. When user accessible USB ports is set to All Ports Off (Dynamic) the Enable Front Ports Only option is enabled.</p> <ul style="list-style-type: none"> • Enable Front Ports Only: Enables or disables the front USB ports during the OS runtime. <p>The USB keyboard and mouse still function in certain USB ports during the boot process, depending on the selection. After the boot process is complete, the USB ports will be enabled or disabled as per the setting.</p>
Internal USB Port	<p>Enables or disables the Internal USB Port. This option is set to On or Off. This option is set to On by default.</p>
iDRAC Direct USB Port	<p>The iDRAC Direct USB port is managed by iDRAC exclusively with no host visibility. This option is set to ON or OFF. When set to OFF, iDRAC does not detect any USB devices installed in this managed port. This option is set to On by default. Enables or disables the integrated RAID controller. When set to Disabled, the device is not visible to the operating system(OS). Enables or disables the integrated RAID controller. When set to Disabled, the device is not visible to the operating system(OS).</p>
Integrated RAID Controller	<p>Enables or disables the integrated RAID controller. When set to Disabled, the device is not visible to the operating system(OS).</p>
Embedded NIC1 and NIC2	<p>Enables or disables the Embedded NIC1 and NIC2 options. If set to Disabled (OS), the NIC may still be available for shared network access by the embedded management controller. Configure the Embedded NIC1 and NIC2 option by using the NIC management utilities of the system.</p>
Embedded Video Controller	<p>Enables or disables the use of Embedded Video Controller as the primary display. When set to Enabled, the Embedded Video Controller will be the primary display even if add-in graphic cards are installed. When set to Disabled, an add-in graphics card will be used as the primary display. BIOS will output displays to both the primary add-in video and the embedded video during POST and pre-boot environment. The embedded video will then be disabled right before the operating system boots. This option is set to Enabled by default.</p> <p>NOTE: When there are multiple add-in graphic cards installed in the system, the first card discovered during PCI enumeration is selected as the primary video. You might have to re-arrange the cards in the slots in order to control which card is the primary video.</p>
Current State of Embedded Video Controller	<p>Displays the current state of the embedded video controller. The Current State of Embedded Video Controller option is a read-only field. If the Embedded Video Controller is the only display capability in the system (that is, no add-in graphics card is installed), then the Embedded Video Controller is automatically used as the primary display even if the Embedded Video Controller setting is set to Disabled.</p>
SR-IOV Global Enable	<p>Enables or disables the BIOS configuration of Single Root I/O Virtualization (SR-IOV) devices. This option is set to Disabled by default.</p>
OS Watchdog Timer	<p>If your system stops responding, this watchdog timer aids in the recovery of your operating system. When this option is set to Enabled, the operating</p>

Table 60. Integrated Devices details (continued)

Option	Description
	system initializes the timer. When this option is set to Disabled (the default), the timer does not have any effect on the system.
Memory Mapped I/O Limit	Controls where MMIO is mapped. The 1 TB option is designed for specific OS which cannot support MMIO over 1 TB. This option is set to 8 TB by default. The default option is the maximum address that the system supports and recommended in most cases.
Slot Disablement	Enables or disables the available PCIe slots on your system. The slot disablement feature controls the configuration of the PCIe cards installed in the specified slot. Slots must be disabled only when the installed peripheral card prevents booting into the operating system or causes delays in system startup. If the slot is disabled, both the Option ROM and UEFI drivers are disabled. Only slots that are present on the system will be available for control. Slot n: Enables or disables or only the boot driver is disabled for the PCIe slot n. This option is set to Enabled by default.
Slot Bifurcation	Slot Discovery Bifurcation Settings allows Platform Default Bifurcation and Manual bifurcation Control . The default is set to Platform Default Bifurcation . The slot bifurcation field is accessible when set to Manual bifurcation Control and is grayed out when set to Platform Default Bifurcation .  NOTE: This option is only available for 3rd Generation AMD EPYC processors.

Serial Communication

To view the **Serial Communication** screen, power on the system, press F2, and click **System Setup Main Menu > System BIOS > Serial Communication**.

Table 61. Serial Communication details





Option	Description
Serial Communication	Selects serial communication devices (Serial Device 1 and Serial Device 2) in BIOS. BIOS console redirection can also be enabled and the port address can be specified. This option is set to Auto by default.
Serial Port Address	Enables you to set the port address for serial devices.  NOTE: You can use only Serial Device 2 for the Serial Over LAN (SOL) feature. To use console redirection by SOL, configure the same port address for console redirection and the serial device.  NOTE: Every time the system boots, the BIOS syncs the serial MUX setting that is saved in iDRAC. The serial MUX setting can independently be changed in iDRAC. Loading the BIOS default settings from within the BIOS setup utility may not always revert the serial MUX setting to the default setting of Serial Device 1.
External Serial Connector	Enables you to associate the External Serial Connector to Serial Device 1 , Serial Device 2 , or the Remote Access Device by using this option. This option is set to Serial Device 1 by default.  NOTE: Only Serial Device 2 can be used for Serial Over LAN (SOL). To use console redirection by SOL, configure the same port address for console redirection and the serial device.  NOTE: Every time the system boots, the BIOS syncs the serial MUX setting saved in iDRAC. The serial MUX setting can independently be changed in iDRAC. Loading the BIOS default settings from within the BIOS

Table 61. Serial Communication details (continued)

Option	Description
	setup utility may not always revert this setting to the default setting of Serial Device 1.
Failsafe Baud Rate	Specifies the failsafe baud rate for console redirection. The BIOS attempts to determine the baud rate automatically. This failsafe baud rate is used only if the attempt fails, and the value must not be changed. This option is set to 115200 by default.
Remote Terminal Type	Sets the remote console terminal type. This option is set to VT100/VT220 by default.
Redirection After Boot	Enables or disables the BIOS console redirection when the operating system is loaded. This option is set to Enabled by default.

System Profile Settings

To view the **System Profile Settings** screen, power on the system, press F2, and click **System Setup Main Menu > System BIOS > System Profile Settings**.

Table 62. System Profile Settings details

Option	Description
System Profile	Sets the system profile. If you set the System Profile option to a mode other than Custom , the BIOS automatically sets the rest of the options. You can only change the rest of the options if the mode is set to Custom . This option is set to Performance Per Watt (OS) by default. Other options include Performance and Custom .  NOTE: All the parameters on the system profile setting screen are available only when the System Profile option is set to Custom .
CPU Power Management	Sets the CPU power management. This option is set to OS DBPM by default. Other option includes Maximum Performance .
Memory Frequency	Sets the speed of the system memory. You can select Maximum Performance or a specific speed. This option is set to Maximum Performance by default.
Turbo Boost	Enables or disables the processor to operate in the turbo boost mode. This option is set to Enabled by default.
C-States	Enables or disables the processor to operate in all available power states. C States allow the processor to enter lower power states when idle. When set to Enabled (OS controlled) or when set to Autonomous (if hardware controlled is supported), the processor can operate in all available Power States to save power, but may increase memory latency and frequency jitter. This option is set to Enabled by default.
Write Data CRC	When set to Enabled , DDR5 data bus issues are detected and corrected during 'write' operations. Two extra cycles are required for CRC bit generation which impacts the performance. Read-only unless System Profile is set to Custom . This option is set to Disabled by default.
Memory Patrol Scrub	Sets the memory patrol scrub mode. This option is set to Standard by default.
Memory Refresh Rate	Sets the memory refresh rate to either 1x or 2x. This option is set to 1x by default.
Workload Profile	Allows optimization of performance based on the workload type. The Workload Profile setting is not a state . Setting a Workload Profile is a one-time action that in turns modifies various BIOS settings to be optimized for the requested workload type. This option is set to Not Configured by default.

Table 62. System Profile Settings details (continued)

Option	Description
PCI ASPM L1 Link Power Management	Enables or disables the PCI ASPM L1 Link Power Management. This option is set to Enabled by default.
Determinism Slider	Set the system determinism by Power Determinism or Performance Determinism . This option is set to Performance Determinism by default.
Power Profile Select	High performance Mode(default): Favors core performance. All DF P-States are available in this mode and the default DF P-State and DLWM algorithms are active. Efficiency Mode: Configures the system for power efficiency. Limits boost frequency available to cores and restricts DF P-States available in the system. Maximum IO Performance Mode: Sets up Date Fabric to maximize IO sub-system performance.
PCIE Speed PMM Control	Reduce link speed when devices are idle. This option is set to Auto by default.
EQ Bypass To Highest Rate	Controls the ability to advertise Equalization Bypass to Highest Rate Support in TSxs sent prior to LinkUp=1r. This option is set to Disabled by default.
DF PState Frequency Optimizer	Disabled: Disabled the DP P-state CCLK effective frequency optimizer. Enabled: Enables the DP P-state CCLK effective frequency optimizer. This option is set to Enabled by default.
DF PState Latency Optimizer	Disabled: Disables the DP P-state latency optimizer. Enabled: Enables the DF P-state latency optimizer. This option is set to Enabled by default.
DF CState	This field enables(0xF)/disables(0x0) DF Cstate. This option is set to Enabled by default.
Host System Management Port(HSMP)Support	This value controls Host System Management Port(HSMP) interface to provide OS-level software with access to system management functions via a set of mail box registers. This option is set to Enabled by default.
Boost FMax	Boost Fmax. This option is set to 0 - Auto by default.
Algorithm Performance Boost Disable (ApbDis)	Enables or disables the Algorithm Performance Boost Disable (ApbDis). This option is set to Disabled by default.
Dynamic Link Width Management (DLWM)	Reduces the xGMI link width between sockets from x16 to x8 (default), when no traffic is detected on the link. This option is set to Unforced by default.

System Security

To view the **System Security** screen, power on the system, press F2, and click **System Setup Main Menu > System BIOS > System Security**.

Table 63. System Security details

Option	Description
CPU AES-NI	Improves the speed of applications by performing encryption and decryption by using the Advanced Encryption Standard Instruction Set (AES-NI). This option is set to Enabled by default.
System Password	Sets the system password. This option is set to Enabled by default and is read-only if the password jumper is not installed in the system.
Setup Password	Sets the setup password. This option is read-only if the password jumper is not installed in the system.
Password Status	Locks the system password. This option is set to Unlocked by default.

Table 64. System Security details

Option	Description
TPM Security	This field controls the reporting of the Trusted Platform Module(TPM) in the system. When set to Off, the presence of the TPM is not reported to the OS.

Table 64. System Security details (continued)

Option	Description
	When set to Off, the presence of the TPM is not reported to the OS. When set to On, the presence of the TPM is reported to the OS.
TPM Information	Indicates the type of Trusted Platform Module, if present.
TPM Firmware	Indicates the firmware version of a Trusted Platform Module(TPM).
TPM Heirachy	Allows enabling, disabling or clearing the storage and endorsement hierarchies. When set to Enabled, the storage and endorsement hierarchies can be used. When set to Disabled, the storage and endorsement hierarchies cannot be used. When set to Clear, the storage and endorsement hierarchies are cleared of any values and then reset to Enabled.
TPM Advanced Settings	TPM PPI Bypass Provision When set to Enabled, allows the Operating System to bypass Physical Presence Interface(PPI) prompts when issuing PPI Advanced Configuration and Power Interface (ACPI) provisioning operations. TPM PPI Bypass Clear When set to Enabled, allows the Operating System to bypass Physical Presence Interface(PPI) prompts when issuing PPI Advanced Configuration and Power Interface (ACPI) clear operations. TPM2 Algorithm Selection Allows the user to change the cryptographic algorithms used in the Trusted Platform Module (TPM). The available options are dependant on the TPM firmware. To enable TPM2 Algorithm Selection, Intel(R) TXT technology must be disabled.
AMD DRTM	Enable/Disable AMD Dynamic Root of Trust Measurement (DRTM) To enable AMD DRTM, below configurations must be enabled: 1. TPM2.0 must be enabled and the hash algorithm must be set to SHA256. 2. Transparent SME (TSME) must be enabled.
Power Button	Enables or disables the power button on the front of the system. This option is set to Enabled by default.
AC Power Recovery	Sets how the system behaves after AC power is restored to the system. This option is set to Last by default.
AC Power Recovery Delay	Sets the time delay for the system to power up after AC power is restored to the system. This option is set to Immediate by default.
User Defined Delay (120s to 600s)	Controls the duration for which the power-on process is delayed after the AC power supply is restored. The value is only effective if AC Power Recovery Delay is set to User Defined . The valid range is between 120s and 600s .
UEFI Variable Access	Provides varying degrees of securing UEFI variables. When set to Standard (the default), UEFI variables are accessible in the operating system per the UEFI specification. When set to Controlled , selected UEFI variables are protected in the environment and new UEFI boot entries are forced to be at the end of the current boot order.
SMM Security Mitigation	This option enables or disables additional UEFI SMM Security Mitigation protections. This option is available only in UEFI boot mode . The operating system can use this feature to help protect the secure environment created by virtualization based security . Enabling this feature provides additional UEFI SMM Security Mitigation protections. However, this feature may cause compatibility issue or loss of functionality with some legacy tools or applications.
Secure Boot	Enables Secure Boot, where the BIOS authenticates each pre-boot image by using the certificates in the Secure Boot Policy. Secure Boot is set to Disabled by default.
Secure Boot Policy	When Secure Boot policy is set to Standard , the BIOS uses the system manufacturer's key and certificates to authenticate pre-boot images. When Secure Boot policy is set to Custom , the BIOS uses the user-defined key and certificates. Secure Boot policy is set to Standard by default.

Table 64. System Security details (continued)

Option	Description
Secure Boot Mode	<p>Configures how the BIOS uses the Secure Boot Policy Objects (PK, KEK, db, dbx). If the current mode is set to Deployed Mode, the available options are User Mode and Deployed Mode.</p> <p>If the current mode is set to User Mode, the available options are User Mode, Audit Mode, and Deployed Mode.</p>
Secure Boot Policy Summary	Specifies the list of certificates and hashes that secure boot uses to authenticate images.
Secure Boot Custom Policy Settings	Configures the Secure Boot Custom Policy. To enable this option, set the Secure Boot Policy to Custom option.

Table 65. Secure Boot Mode

Options	Descriptions
User Mode	In User Mode , PK must be installed, and BIOS performs signature verification on programmatic attempts to update policy objects. The BIOS allows unauthenticated programmatic transitions between modes.
Deployed Mode	Deployed Mode is the most secure mode. In Deployed Mode , PK must be installed and the BIOS performs signature verification on programmatic attempts to update policy objects. Deployed Mode restricts the programmatic mode transitions.
Audit Mode	In Audit mode , PK is not present. The BIOS does not authenticate programmatic updates to the policy objects, and transitions between modes. The BIOS performs a signature verification on pre-boot images and logs the results in the image Execution Information Table, but executes the images whether they pass or fail verification. Audit Mode is useful for programmatic determination of a working set of policy objects.

Creating a system and setup password

Prerequisites

Ensure that the password jumper is enabled. The password jumper enables or disables the system password and setup password features. For more information, see the System board jumper settings section.

i **NOTE:** If the password jumper setting is disabled, the existing system password and setup password are deleted and you need not provide the system password to boot the system.

Steps

- To enter System Setup, press F2 immediately after turning on or rebooting your system.
- On the **System Setup Main Menu** screen, click **System BIOS > System Security**.
- On the **System Security** screen, verify that **Password Status** is set to **Unlocked**.
- In the **System Password** field, type your system password, and press Enter or Tab.

Use the following guidelines to assign the system password:

 - A password can have up to 32 characters.

A message prompts you to reenter the system password.
- Reenter the system password, and click **OK**.
- In the **Setup Password** field, type your setup password and press Enter or Tab.

A message prompts you to reenter the setup password.

7. Reenter the setup password, and click **OK**.
8. Press Esc to return to the System BIOS screen. Press Esc again.
A message prompts you to save the changes.

 **NOTE:** Password protection does not take effect until the system reboots.

Using your system password to secure your system

About this task

If you have assigned a setup password, the system accepts your setup password as an alternate system password.

Steps

1. Turn on or reboot your system.
2. Type the system password and press Enter.

Next steps

When **Password Status** is set to **Locked**, type the system password and press Enter when prompted at reboot.

 **NOTE:** If an incorrect system password is typed, the system displays a message and prompts you to reenter your password. You have three attempts to type the correct password. After the third unsuccessful attempt, the system displays an error message that the system has stopped functioning and must be turned off. Even after you turn off and restart the system, the error message is displayed until the correct password is entered.

Deleting or changing system and setup password

Prerequisites

 **NOTE:** You cannot delete or change an existing system or setup password if the **Password Status** is set to **Locked**.

Steps

1. To enter System Setup, press F2 immediately after turning on or restarting your system.
2. On the **System Setup Main Menu** screen, click **System BIOS > System Security**.
3. On the **System Security** screen, ensure that **Password Status** is set to **Unlocked**.
4. In the **System Password** field, alter or delete the existing system password, and then press Enter or Tab.
5. In the **Setup Password** field, alter or delete the existing setup password, and then press Enter or Tab.
If you change the system and setup password, a message prompts you to reenter the new password. If you delete the system and setup password, a message prompts you to confirm the deletion.
6. Press Esc to return to the **System BIOS** screen. Press Esc again, and a message prompts you to save the changes.
7. Select **Setup Password**, change, or delete the existing setup password and press Enter or Tab.

 **NOTE:** If you change the system password or setup password, a message prompts you to reenter the new password. If you delete the system password or setup password, a message prompts you to confirm the deletion.

Operating with setup password enabled

If **Setup Password** is set to **Enabled**, type the correct setup password before modifying the system setup options.

If you do not type the correct password in three attempts, the system displays the following message:

```
Invalid Password! Number of unsuccessful password attempts: <x> System Halted! Must power down.
```

```
Password Invalid. Number of unsuccessful password attempts: <x> Maximum number of password attempts exceeded. System halted.
```

Even after you turn off and restart the system, the error message is displayed until the correct password is typed. The following options are exceptions:

- If **System Password** is not set to **Enabled** and is not locked through the **Password Status** option, you can assign a system password. For more information, see the System Security Settings screen section.
- You cannot disable or change an existing system password.

NOTE: You can use the password status option with the setup password option to protect the system password from unauthorized changes.

Redundant OS Control

To view the **Redundant OS Control** screen, power on the system, press F2, and click **System Setup Main Menu > System BIOS > Redundant OS Control**.

Table 66. Redundant OS Control details

Option	Description
Redundant OS Location	Enables you to select a backup disk from the following devices: <ul style="list-style-type: none"> • None • Internal M.2 Drives
Redundant OS State	<p>NOTE: This option is disabled if Redundant OS Location is set to None.</p> <p>When set to Visible, the backup disk is visible to the boot list and OS. When set to Hidden, the backup disk is disabled and is not visible to the boot list and OS. This option is set to Visible by default.</p> <p>NOTE: BIOS disables the device in hardware, so it is not accessed by the OS.</p>
Redundant OS Boot	<p>NOTE: This option is disabled if Redundant OS Location is set to None or if Redundant OS State is set to Hidden.</p> <p>When set to Enabled, BIOS boots to the device specified in Redundant OS Location. When set to Disabled, BIOS preserves the current boot list settings. This option is set to Enabled by default.</p>

Miscellaneous Settings

To view the **Miscellaneous Settings** screen, power on the system, press F2, and click **System Setup Main Menu > System BIOS > Miscellaneous Settings**.

Table 67. Miscellaneous Settings details

Option	Description
System Time	Enables you to set the time on the system.
System Date	Enables you to set the date on the system.
Time Zone	Times offset from UTC.
Daylight Savings Time	Enables or disables the Daylight Savings Time option. This option is set to Disabled by default.
Asset Tag	Specifies the asset tag and enables you to modify it for security and tracking purposes.
Keyboard NumLock	Enables you to set whether the system boots with the NumLock enabled or disabled. This option is set to On by default. <p>NOTE: This option does not apply to 84-key keyboards.</p>
F1/F2 Prompt on Error	Enables or disables the F1/F2 prompt on error. This option is set to Enabled by default. The F1/F2 prompt also includes keyboard errors.

Table 67. Miscellaneous Settings details (continued)

Option	Description
Load Legacy Video Option ROM	Enables or disables the Load Legacy Video Option ROM option. This option is set to Disabled by default.
Dell Wyse P25/P45 BIOS Access	Enables or disables the Dell Wyse P25/P45 BIOS Access. This option is set to Enabled by default.
Power Cycle Request	Enables or disables the Power Cycle Request. This option is set to None by default.

iDRAC Settings utility

The iDRAC settings utility is an interface to set up and configure the iDRAC parameters by using UEFI. You can enable or disable various iDRAC parameters by using the iDRAC settings utility.

 **NOTE:** Accessing some of the features on the iDRAC settings utility needs the iDRAC Enterprise License upgrade.

For more information about using iDRAC, see *Dell Integrated Dell Remote Access Controller User's Guide* at <https://www.dell.com/idracmanuals>.

Device Settings

Device Settings enables you to configure device parameters such as storage controllers or network cards.

Dell Lifecycle Controller

Dell Lifecycle Controller (LC) provides advanced embedded systems management capabilities including system deployment, configuration, update, maintenance, and diagnosis. LC is delivered as part of the iDRAC out-of-band solution and Dell system embedded Unified Extensible Firmware Interface (UEFI) applications.

Embedded system management

The Dell Lifecycle Controller provides advanced embedded system management throughout the lifecycle of the system. The Dell Lifecycle Controller is started during the boot sequence and functions independently of the operating system.

 **NOTE:** Certain platform configurations may not support the full set of features provided by the Dell Lifecycle Controller.

For more information about setting up the Dell Lifecycle Controller, configuring hardware and firmware, and deploying the operating system, see the Dell Lifecycle Controller documentation at <https://www.dell.com/idracmanuals>.

Boot Manager

The **Boot Manager** option enables you to select boot options and diagnostic utilities.

To enter **Boot Manager**, power on the system and press F11.

Table 68. Boot Manager details

Option	Description
Continue Normal Boot	The system attempts to boot to devices starting with the first item in the boot order. If the boot attempt fails, the system continues with the next item in the boot order until the boot is successful or no more boot options are found.
One-shot UEFI Boot Menu	Enables you to access boot menu, where you can select a one-time boot device to boot from.

Table 68. Boot Manager details (continued)

Option	Description
Launch System Setup	Enables you to access System Setup.
Launch Lifecycle Controller	Exits the Boot Manager and invokes the Dell Lifecycle Controller program.
System Utilities	Enables you to launch System Utilities menu such as Launch Diagnostics, BIOS update File Explorer, Reboot System.

PXE boot

You can use the Preboot Execution Environment (PXE) option to boot and configure the networked systems remotely.

To access the **PXE boot** option, boot the system and then press F12 during POST instead of using standard Boot Sequence from BIOS Setup. It does not pull any menu or allows managing of network devices.

Minimum to POST and system management configuration validation

This section describes the minimum to POST system requirement and system management configuration validation of the Dell system.

Topics:

- [Minimum configuration to POST](#)
- [Configuration validation](#)

Minimum configuration to POST

The components listed below are the minimum configuration to POST:

- One processor in processor socket 1
- One memory modules (DIMM) in slot A1
- One power supply unit
- System board + LOM + RIO card

Configuration validation

The new generation of Dell systems have added interconnect flexibility and advanced iDRAC management features to collect precise system configuration information and report configuration errors.

When the system is powered on, information about installed cables, risers, backplanes, power supplies, floating card (fPERC, BOSS), and processor is obtained from the CPLD and backplane memory maps are analyzed. This information forms a unique configuration, which is compared with one of the qualified configurations that are stored in a table maintained by iDRAC.

One or more sensors are assigned to each of the configuration elements. During POST, any configuration validation error is logged in the System Event Log (SEL)/LifeCycle (LC) log. The reported events are categorized in the configuration validation error table.

Table 69. Configuration validation error

Error	Description	Possible cause and recommendations	Example
Config Error	A configuration element within the closest match contains something that is unexpected and does not match any Dell qualified configuration.	Wrong configuration	Config Error: Backplane cable CTRS_SRC_SA1 and BP-DST_SA1
		The element reported in HWC8010 errors are assembled incorrectly. Verify element (cable, risers, etc) placement in the system.	Config Error : SL Cable PLANAR_SL7 and CTRL_DST_PA1
Config Missing	iDRAC found a configuration element missing within the closest match detected.	Missing or damaged cable, device, or part	Config Missing: Float card front PERC/HBAadapter PERC/HBA
		Missing element or cable is reported in HWC8010 error logs. Install the missing element (cable, risers, etc).	Config Missing : SL cable PLANAR_SL8 and CTRL_DST_PA1

Table 69. Configuration validation error (continued)

Error	Description	Possible cause and recommendations	Example
Comm Error	A configuration element is not responding to iDRAC using the management interface while running an inventory check.	System management sideband communication Unplug AC Power, reseal the element and replace the element if the problem persists.	Comm Error: Backplane 2

Error messages

This section describes the error messages displayed on the screen during POST or captured in the system event log (SEL)/ LifeCycle (LC) log.

Table 70. Error message HWC8010

Error code	HWC8010
Message	The System Configuration Check operation resulted in the following issue involving the indicated component type
Arguments	Riser, floating card (fPERClike BOSS), backplane, processor, cable, or other components
Detailed Description	The issue identified in the message is observed in the System Configuration Check operation.
Recommended Response Action	Do the following and retry the operation: <ol style="list-style-type: none"> 1. Disconnect the input power. 2. Check for proper cable connection and component placement. If the issue persists, contact the service provider.
Category	System Health (HWC = Hardware Config)
Severity	Critical
Trap/EventID	2329

Table 71. Error message HWC8011

Error code	HWC8011
Message	The System Configuration Check operation resulted in multiple issues involving the indicated component type
Arguments	Riser, floating card (fPERClike BOSS), backplane, processor, cable, or other components
Detailed Description	Multiple issues are observed in the System Configuration Check operation.
Recommended Response Action	Do the following and retry the operation: <ol style="list-style-type: none"> 1. Disconnect the input power. 2. Check for proper cable connection and component placement. If the issue persists, contact the service provider.
Category	System Health (HWC = Hardware Config)
Severity	Critical

Installing and removing system components

Topics:

- Safety instructions
- Before working inside your system
- After working inside your system
- Recommended tools
- Optional front bezel
- System cover
- Drive backplane cover
- Air shroud
- Cooling fan
- Drives
- Rear drive module
- Drive backplane
- Side wall brackets
- Cable routing
- PERC module
- System memory
- Processor and heat sink
- Expansion cards and expansion card risers
- Optional serial COM port
- BOSS-N1 module
- System battery
- Optional internal USB card
- Intrusion switch module
- Optional OCP card
- Power supply unit
- Trusted Platform Module
- System board
- LOM card and rear I/O board
- Control panel

Safety instructions

 **NOTE:** To avoid injury, do not lift the system on your own. Get others to assist you.

 **WARNING:** Opening or removing the system cover while the system is turned on may expose you to a risk of electric shock..

 **CAUTION:** Many repairs may only be done by a certified service technician. You should only perform troubleshooting and simple repairs as authorized in your product documentation, or as directed by the online or telephone service and support team. Damage due to servicing that is not authorized by Dell is not covered by your warranty. Read and follow the safety instructions that are shipped with your product.

 **CAUTION:** To ensure proper operation and cooling, all system bays and fans must be always populated with a component or a blank.

 **NOTE:** It is recommended that you always use an antistatic mat and antistatic strap while working on components inside the system.

- NOTE:** While replacing the hot swappable PSU, after next server boot; the new PSU automatically updates to the same firmware and configuration of the replaced one. For more information about the Part replacement configuration, see the *Lifecycle Controller User's Guide* at <https://www.dell.com/idracmanuals>
- NOTE:** While replacing faulty storage controller/FC/NIC card with the same type of card, after you power on the system; the new card automatically updates to the same firmware and configuration of the faulty one. For more information about the Part replacement configuration, see the *Lifecycle Controller User's Guide* at <https://www.dell.com/idracmanuals>
- NOTE:** For detailed information on cabling the PERC 11 cards, see the system-specific owner's manual at Installation and Service Manual available at <https://www.dell.com/poweredgemanuals>

Before working inside your system

Prerequisites

Follow the safety guidelines listed in [Safety instructions](#).

Steps

1. Power off the system and all attached peripherals.
2. Disconnect the system from the electrical outlet, and disconnect the peripherals.
3. If applicable, remove the system from the rack.
For more information, see the *Rail Installation Guide* relevant to your rail solutions at www.dell.com/poweredgemanuals.
4. Remove the system cover.

After working inside your system

Prerequisites

Follow the safety guidelines listed in [Safety instructions](#).

Steps

1. Replace the system cover.
2. If applicable, install the system into the rack.
For more information, see the *Rail Installation Guide* relevant to your rail solutions at www.dell.com/poweredgemanuals.
3. Reconnect the peripherals and connect the system to the electrical outlet, and then power on the system.

Recommended tools

You may need some or all of the following tools to perform the removal and installation procedures:

- Key to the bezel lock. The key is required only if your system includes a bezel.
- Phillips 1 screwdriver
- Phillips 2 screwdriver
- Torx T8 screwdriver
- Torx T6 screwdriver
- Torx T20 screwdriver
- 5 mm hex nut screwdriver
- Plastic scribe
- 1/4-inch flat blade screwdriver
- Wrist grounding strap connected to the ground
- ESD mat
- Needle-nose pliers

You need the following tools to assemble the cables for a DC power supply unit:

- AMP 90871-1 hand-crimping tool or equivalent
- Tyco Electronics 58433-3 or equivalent
- Wire-stripper pliers to remove insulation from size 10 AWG solid or stranded, insulated copper wire

i **NOTE:** Use alpha wire part number 3080 or equivalent (65/30 stranding).

i **NOTE:** For information about DC PSU cabling instructions, go to <https://www.dell.com/poweredgemanuals> > **Rack Servers** > PowerEdge R7625 > **Select This Product** > **Documentation** > **Manuals and Documents** > *Cabling instructions for – 48 – 60 V DC power supply.*

Optional front bezel

Removing the front bezel

The procedure to remove the front bezel with and without the LCD panel is the same.

Prerequisites

1. Follow the safety guidelines listed in the [Safety instructions](#).
2. Keep the bezel key handy.

i **NOTE:** The bezel key is part of the LCD bezel package.

Steps

1. Unlock the bezel.
2. Press the release button, and disengage the left end of the bezel.
3. Unhook the right end, and remove the bezel.

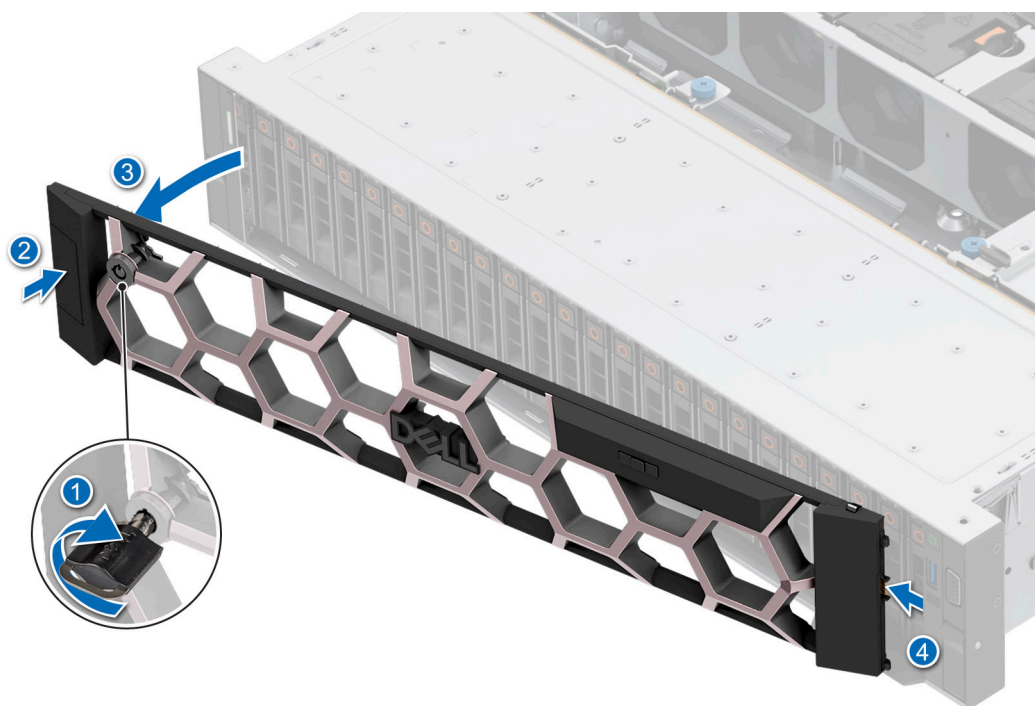

Figure 25. Removing the front bezel

Next steps

1. [Replace the front bezel.](#)

Installing the front bezel

The procedure to install the front bezel with and without the LCD panel is the same.

Prerequisites

1. Follow the safety guidelines listed in the [Safety instructions](#).
2. Locate and remove the bezel key.

NOTE: The bezel key is part of the LCD bezel package.

Steps

1. Align and insert the tabs on the bezel into the slots on the system.
2. Press the bezel until the release button clicks in place.
3. Lock the bezel.

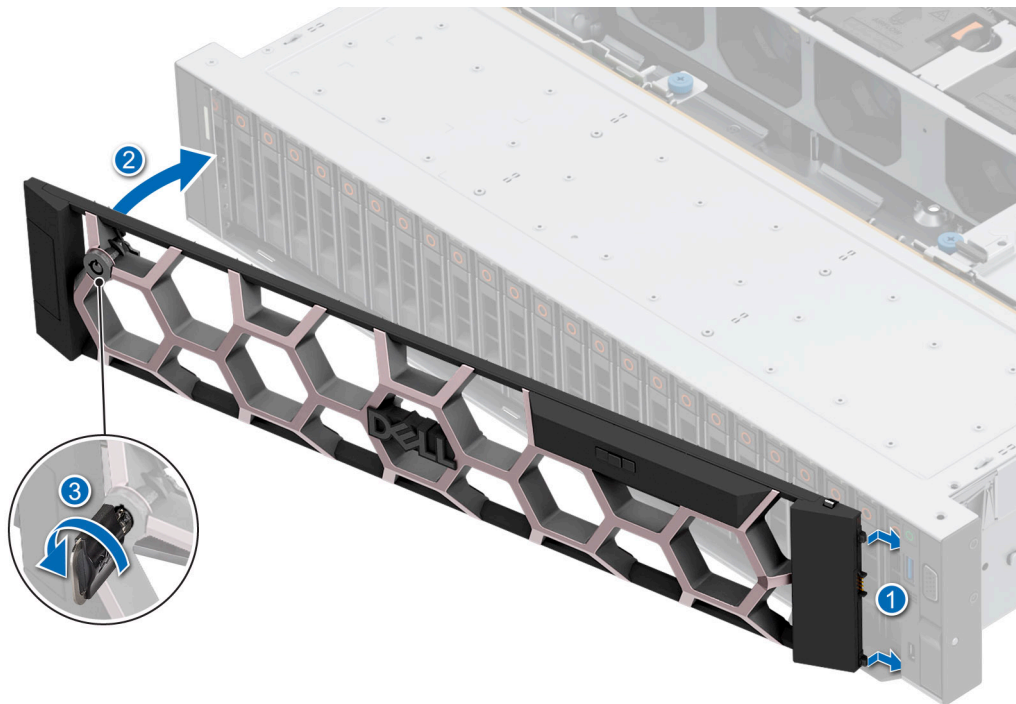

Figure 26. Installing the front bezel

System cover

Removing the system cover

Prerequisites

1. Follow the safety guidelines listed in the [Safety instructions](#).
2. Power off the system, and any attached peripherals.
3. Disconnect the system from the electrical outlet and peripherals.

Steps

1. Using a 1/4-inch flat head or a Phillips #2 screwdriver rotate the lock counterclockwise to the unlock position.
2. Lift the release latch until the system cover slides back.
3. Lift the cover from the system.



Figure 27. Removing the system cover

Next steps

1. [Replace the system cover.](#)

Installing the system cover

Prerequisites

1. Follow the safety guidelines listed in the [Safety instructions](#).
2. Follow the procedure listed in [Before working inside your system](#).
3. Ensure that all internal cables are connected and routed properly, and no tools or extra parts are left inside the system.

Steps

1. Align the tabs on the system cover with the guide slots on the system and slide the system cover.
2. Close the system cover release latch.
3. Using a 1/4-inch flat head or Phillips #2 screwdriver, rotate the lock clockwise to the lock position.



Figure 28. Installing the system cover

Next steps

1. Follow the procedure listed in [After working inside your system](#).

Drive backplane cover

Removing the drive backplane cover

Prerequisites

1. Follow the safety guidelines listed in the [Safety instructions](#).
2. Follow the procedure listed in [Before working inside your system](#).

Steps

1. Slide the backplane cover in the direction of the arrows marked on the drive backplane cover.
2. Lift the backplane cover from the system.

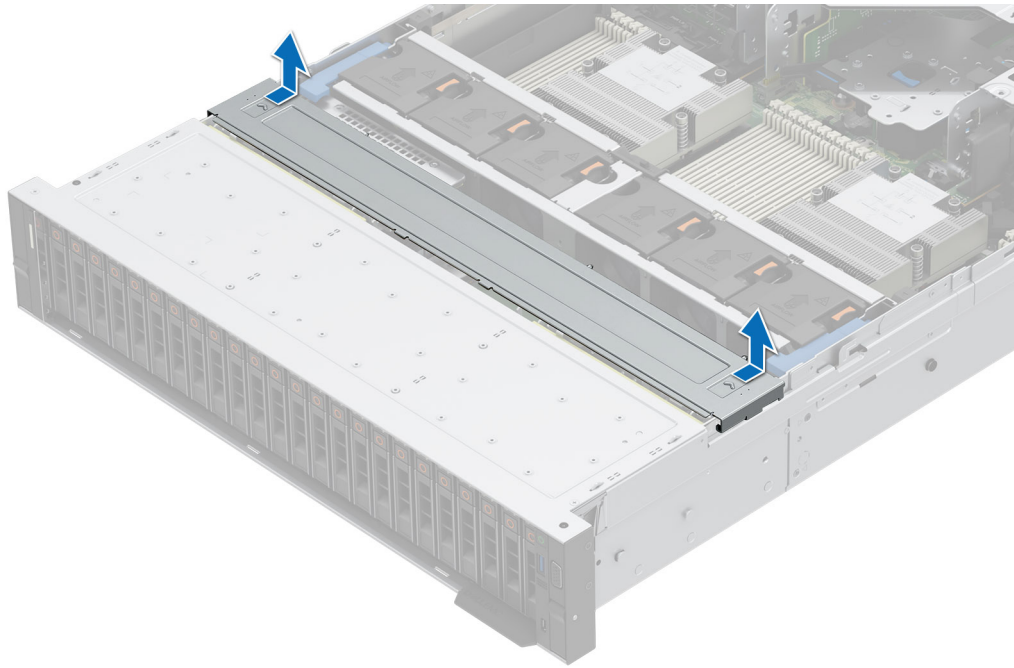

Figure 29. Removing the drive backplane cover

Next steps

1. [Replace the drive backplane cover.](#)

Installing the drive backplane cover

Prerequisites

1. Follow the safety guidelines listed in the [Safety instructions](#).

Steps

1. Align the drive backplane cover with the guide slots on the system.
2. Slide the drive backplane cover to the front of the system until the drive backplane cover fits into place.

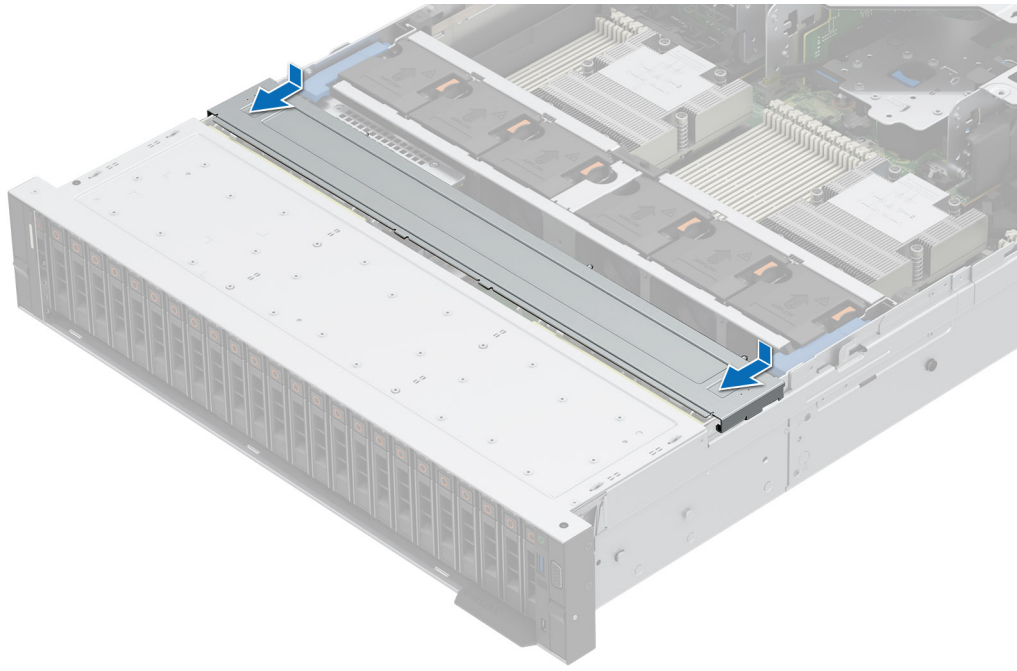

Figure 30. Installing the drive backplane cover

Next steps

1. Follow the procedure listed in [After working inside your system.](#)

Air shroud

Removing the air shroud

Prerequisites

CAUTION: Never operate your system with the air shroud removed. The system may get overheated quickly, resulting in shutdown of the system and loss of data.

1. Follow the safety guidelines listed in the [Safety instructions](#).
2. Follow the procedure listed in [Before working inside your system](#).

Steps

Hold the edges of the air shroud, and lift the air shroud out of the system.

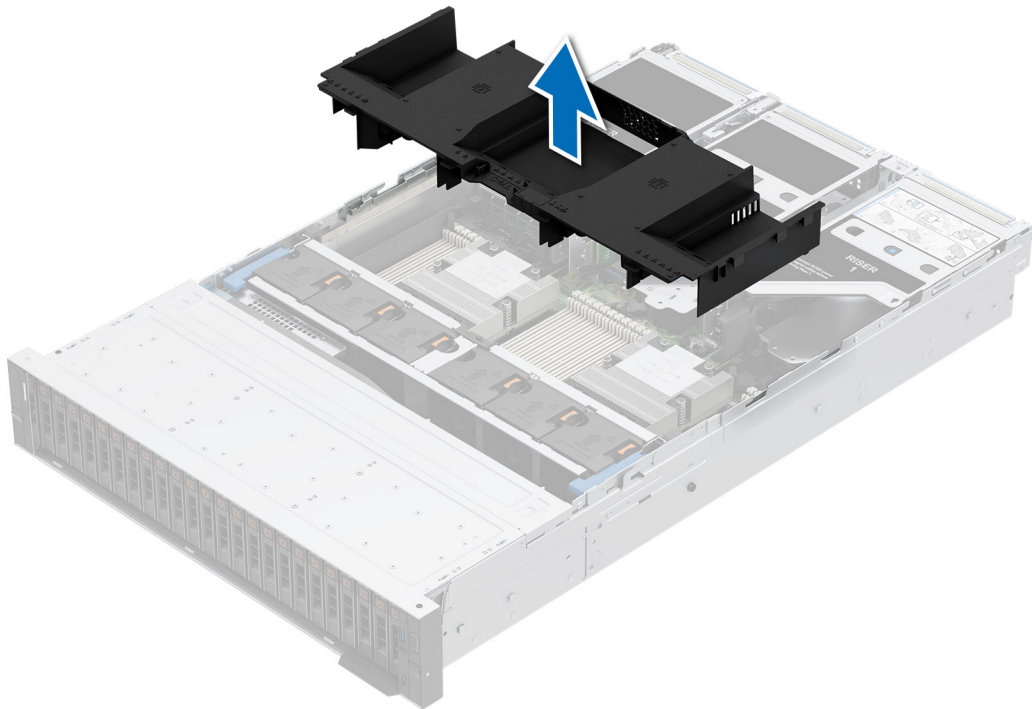

Figure 31. Removing the air shroud

Next steps

1. [Replace the air shroud](#).

Installing the air shroud

Prerequisites

1. Follow the safety guidelines listed in the [Safety instructions](#).
2. Follow the procedure listed in [Before working inside your system](#).

Steps

1. Align the slot on the air shroud with the standoff on the system.

NOTE: Route the cables properly to prevent the cables from being pinched or crimped.

2. Lower the air shroud into the system until it is firmly seated.

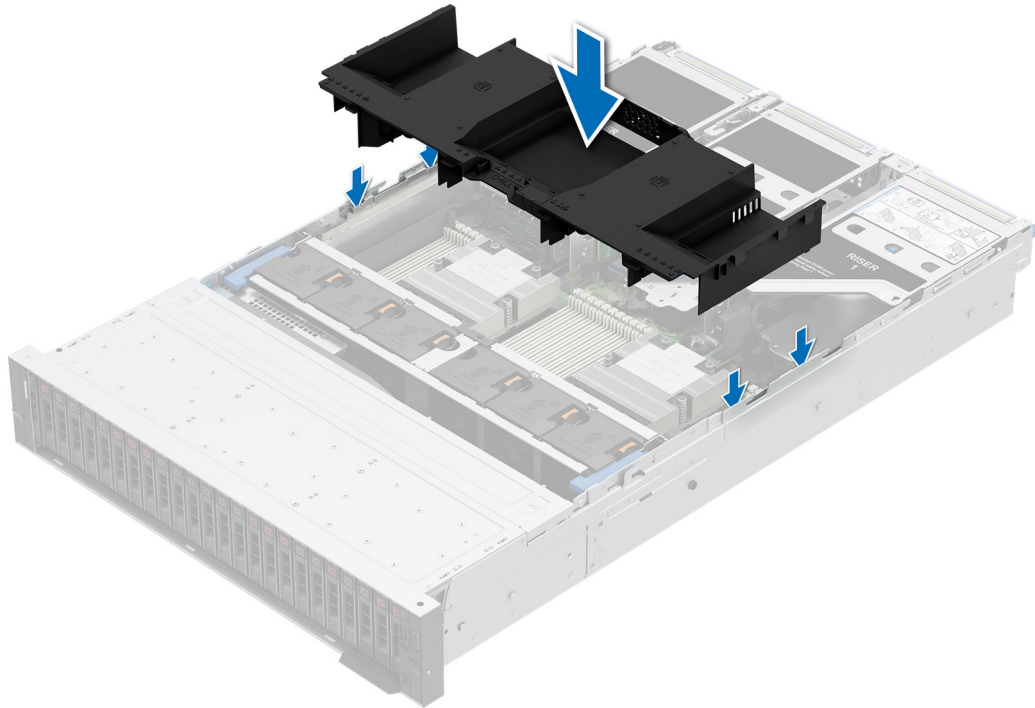

Figure 32. Installing the air shroud

Next steps

1. Follow the procedure listed in [After working inside your system](#).

Removing the GPU air shroud top cover

Prerequisites

CAUTION: Never operate your system with the air shroud removed. The system may get overheated quickly, resulting in shutdown of the system and loss of data.

1. Follow the safety guidelines listed in the [Safety instructions](#).
2. Follow the procedure listed in [Before working inside your system](#).

Steps

Press the blue tabs on either sides of the top cover, and lift the top cover out of the GPU air shroud.

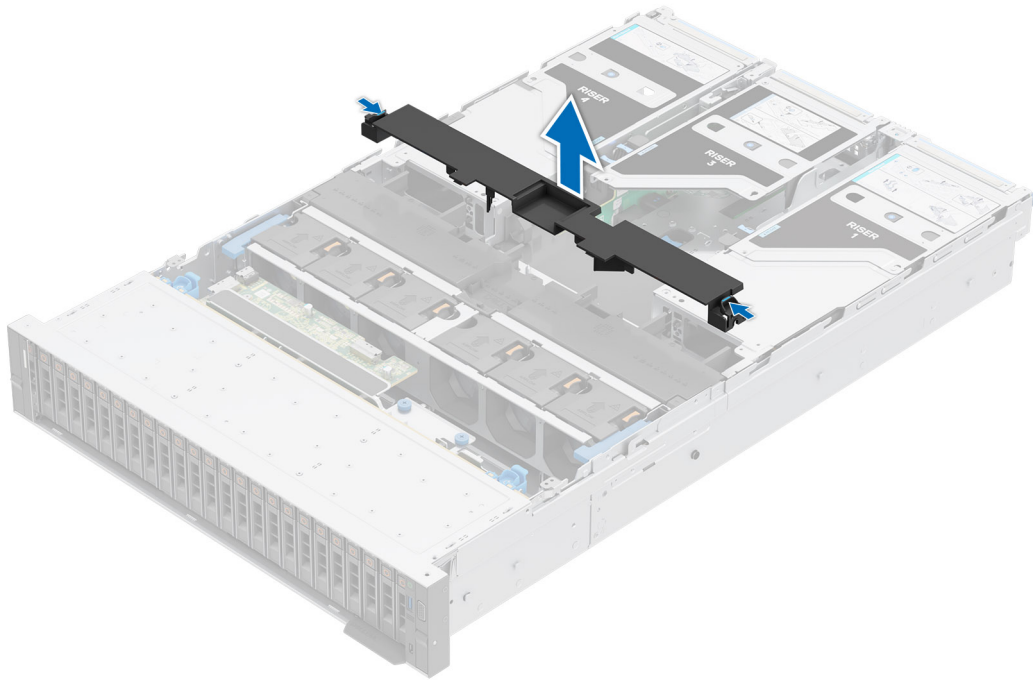

Figure 33. Removing the GPU air shroud top cover

Next steps

1. [Replace the GPU air shroud top cover.](#)

Installing the GPU air shroud top cover

Prerequisites

1. Follow the safety guidelines listed in the [Safety instructions](#).
2. Follow the procedure listed in [Before working inside your system](#).

Steps

1. Align the tabs on the top cover with the slots on the GPU air shroud.
2. Lower the top cover into the GPU air shroud until it is firmly seated.

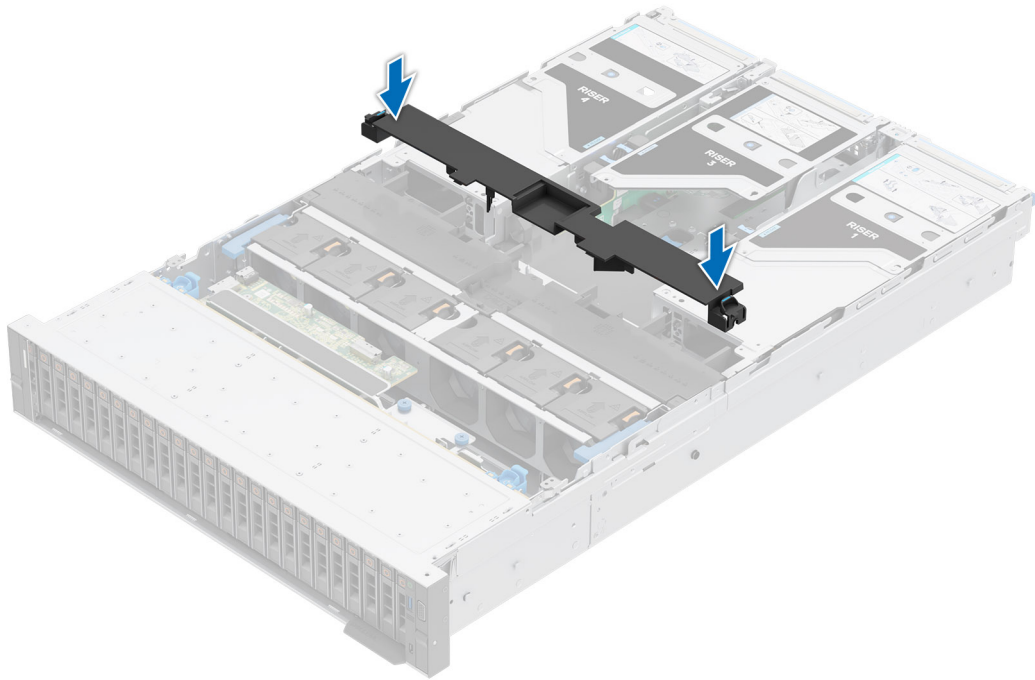

Figure 34. Installing the GPU air shroud top cover

Next steps

1. Follow the procedure listed in [After working inside your system](#).

Removing the GPU air shroud filler

Prerequisites

1. Follow the safety guidelines listed in the [Safety instructions](#).
2. Follow the procedure listed in [Before working inside your system](#).

 **CAUTION:** Never operate your system with the air shroud removed. The system may get overheated quickly, resulting in shutdown of the system and loss of data.

3. Remove the GPU air shroud top cover.

 **NOTE:** The GPU air shroud filler must be removed to avoid interference with full length double-width GPU card installation.

Steps

Hold and lift the filler from the GPU air shroud.

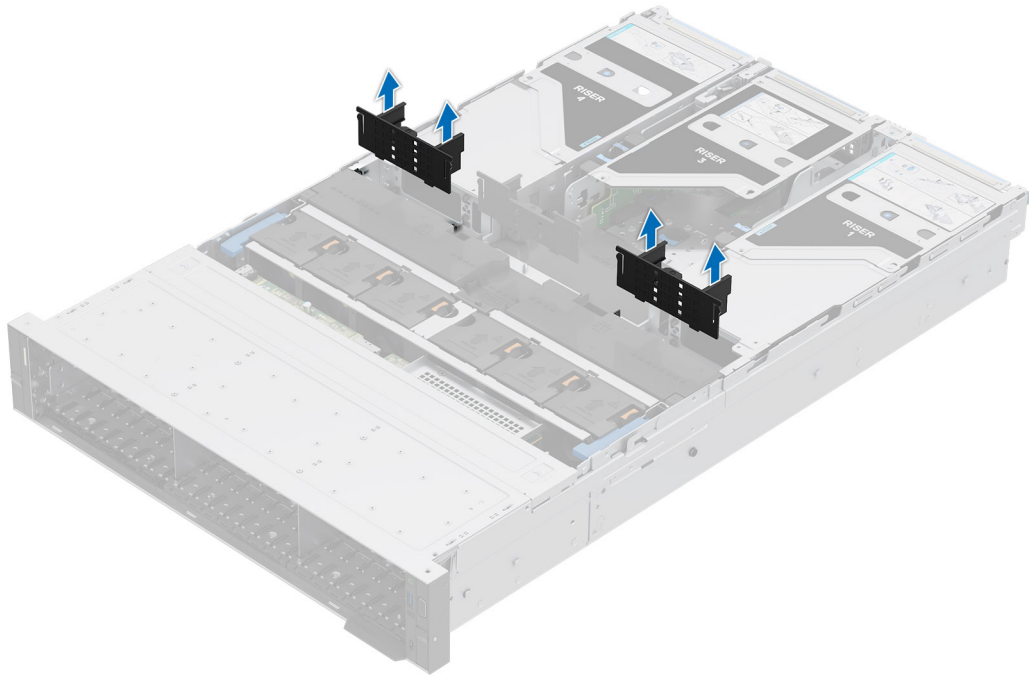

Figure 35. Removing the GPU air shroud filler

Next steps

1. [Replace the GPU air shroud filler.](#)

Installing the GPU air shroud filler

Prerequisites

1. Follow the safety guidelines listed in the [Safety instructions](#).
2. Follow the procedure listed in [Before working inside your system](#).
3. [Remove the GPU air shroud top cover](#).
4. If required, [remove the full length expansion card risers](#).

i **NOTE:** The GPU air shroud filler must be installed, if single-width GPU card or empty riser is used.

Steps

Align and install the filler into the slots on the GPU air shroud.

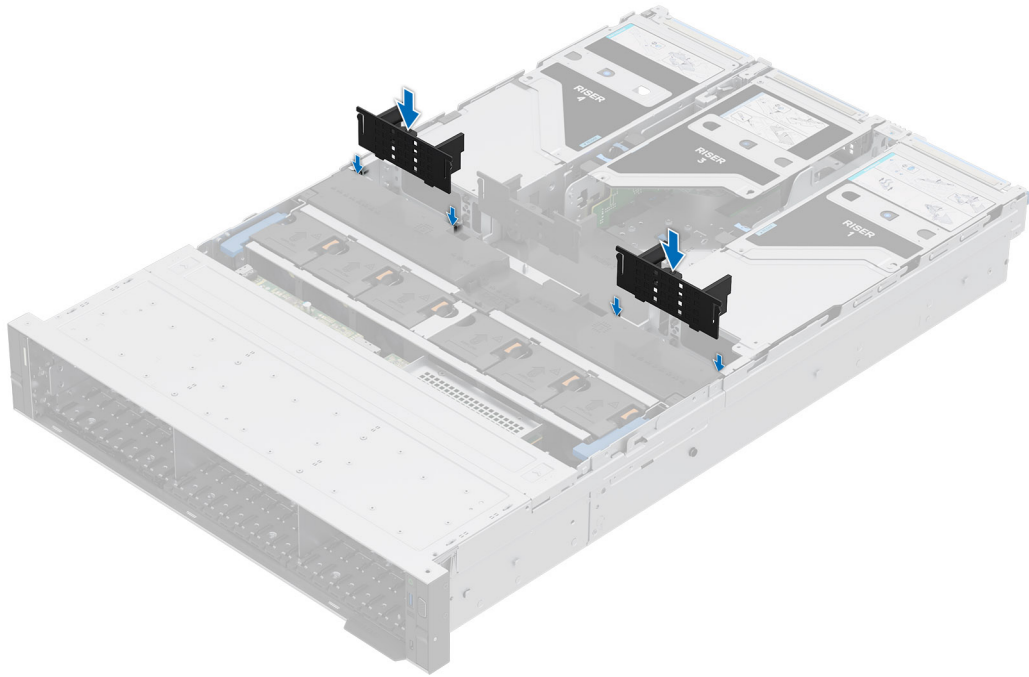

Figure 36. Installing the GPU air shroud filler

Next steps

1. [Install the GPU air shroud top cover.](#)
2. Follow the procedure listed in [After working inside your system.](#)

Removing the GPU air shroud

Prerequisites

CAUTION: Never operate your system with the air shroud removed. The system may get overheated quickly, resulting in shutdown of the system and loss of data.

1. Follow the safety guidelines listed in the [Safety instructions.](#)
2. Follow the procedure listed in [Before working inside your system.](#)
3. [Remove the GPU air shroud top cover.](#)
4. [Remove the full length expansion card risers.](#)

Steps

Hold the edges of the GPU air shroud, and lift the air shroud out of the system.

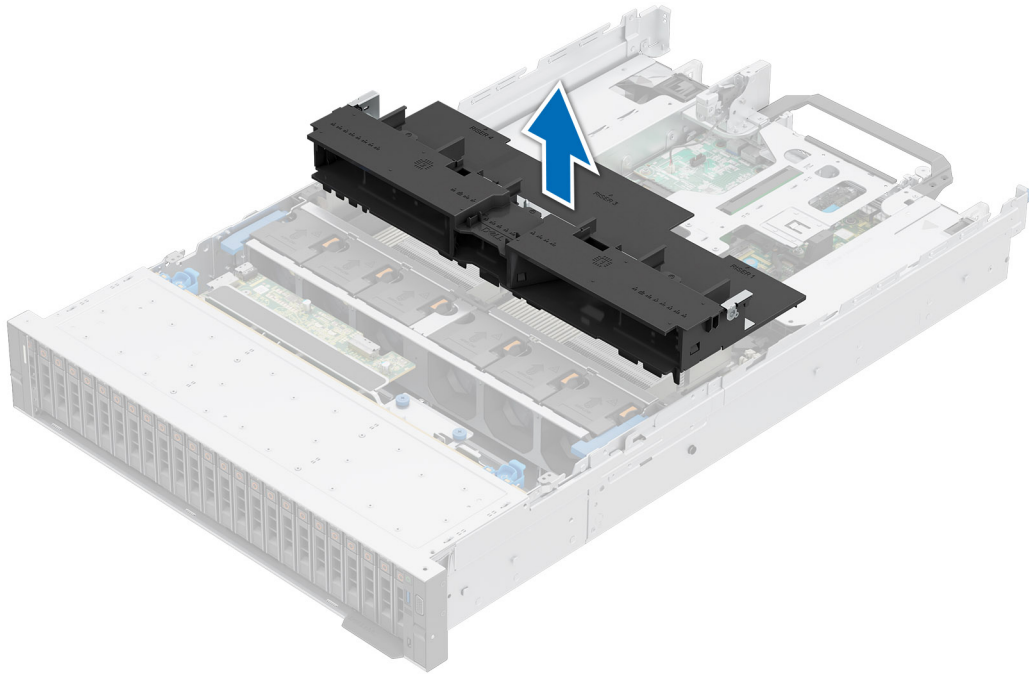

Figure 37. Removing the GPU air shroud

Next steps

1. [Replace the GPU air shroud.](#)

Installing the GPU air shroud

Prerequisites

1. Follow the safety guidelines listed in the [Safety instructions](#).
2. Follow the procedure listed in [Before working inside your system](#).
3. [Remove the GPU air shroud top cover.](#)
4. [Remove the full length expansion card risers.](#)

Steps

1. Align the slot on the GPU air shroud with the standoff on the system.
2. Lower the GPU air shroud into the system until it is firmly seated.

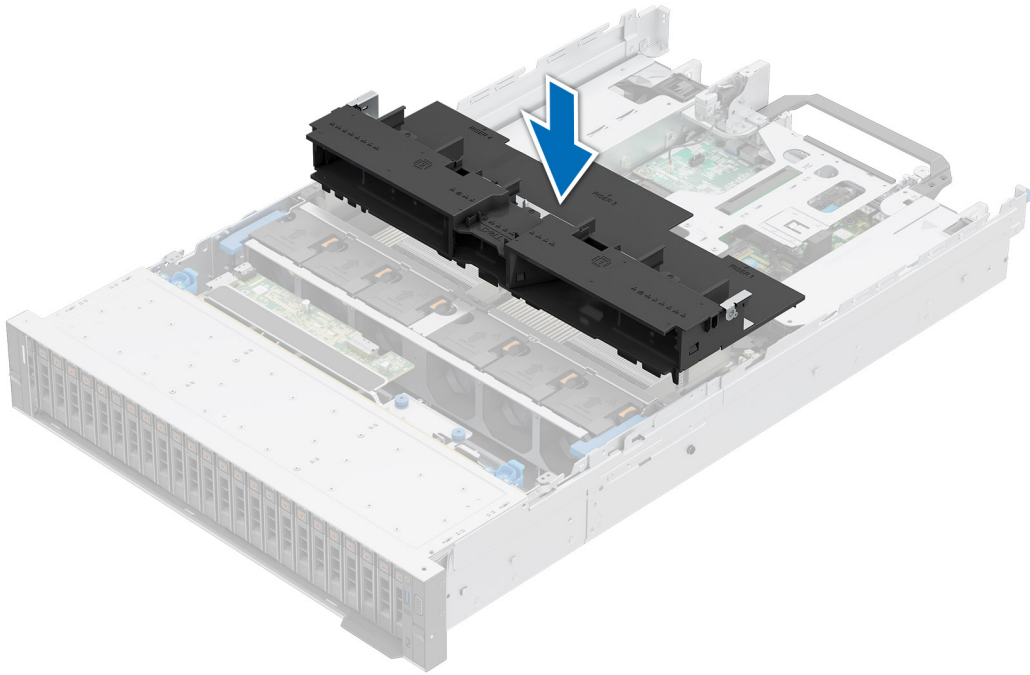

Figure 38. Installing the GPU air shroud

Next steps

1. Install the full length expansion risers.
2. Install the GPU air shroud top cover.
3. Follow the procedure listed in [After working inside your system](#).

Removing the 2 x 2.5-inch rear drive module air shroud

Prerequisites

CAUTION: Never operate your system with the air shroud removed. The system may get overheated quickly, resulting in shutdown of the system and loss of data.

1. Follow the safety guidelines listed in the [Safety instructions](#).
2. Follow the procedure listed in [Before working inside your system](#).

Steps

Press the edges and lift the air shroud out of the rear drive module.

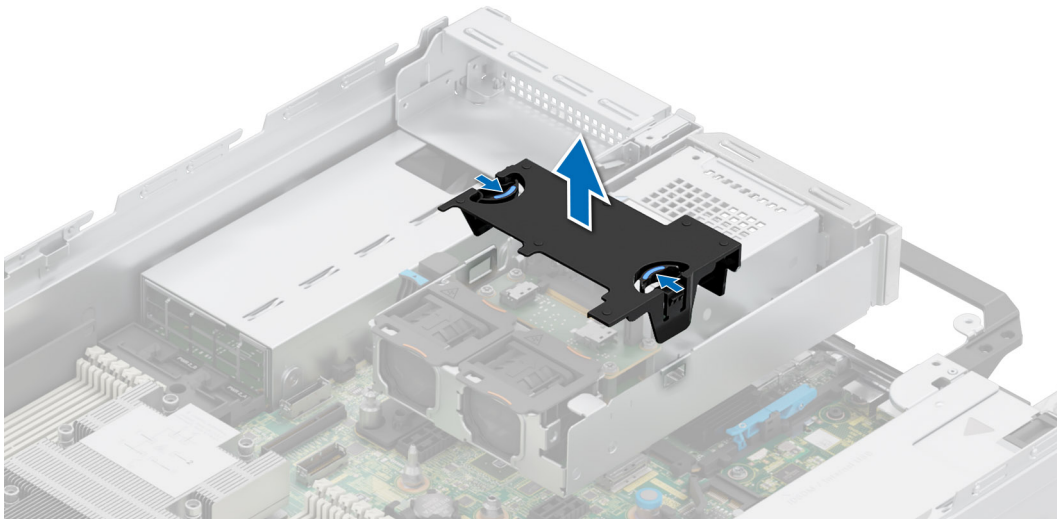

Figure 39. Removing the 2 x 2.5-inch rear drive module air shroud

Next steps

1. Replace the 2 x 2.5-inch rear drive module air shroud.

Installing the 2 x 2.5-inch rear drive module air shroud

Prerequisites

1. Follow the safety guidelines listed in the [Safety instructions](#).
2. Follow the procedure listed in [Before working inside your system](#).

Steps

1. Align the tabs on the air shroud with the slots on the rear drive module.
2. Lower the air shroud into the rear drive module until it is firmly seated.

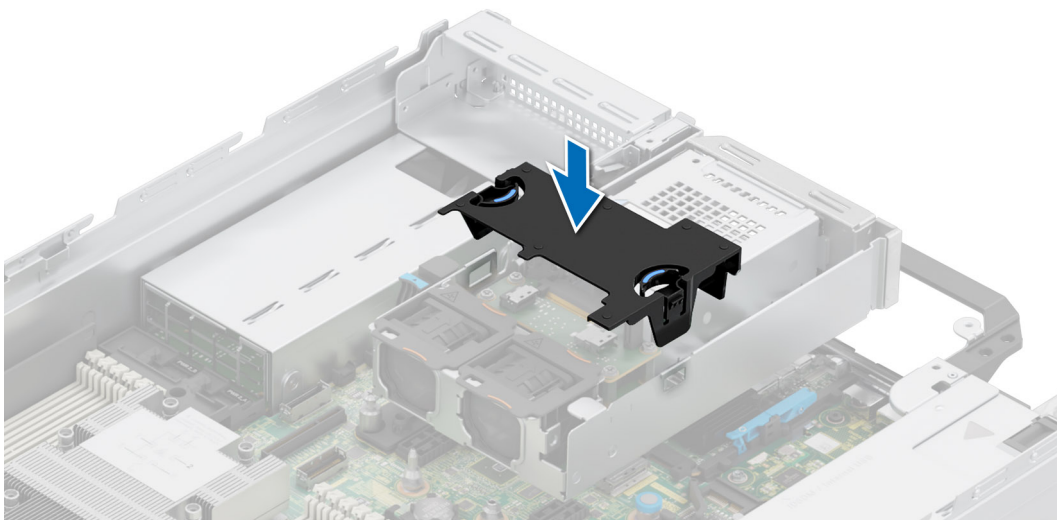

Figure 40. Installing the 2 x 2.5-inch rear drive module air shroud

Next steps

1. Follow the procedure listed in [After working inside your system](#).

Removing the 4 x 2.5-inch rear drive module air shroud

Prerequisites

CAUTION: Never operate your system with the air shroud removed. The system may get overheated quickly, resulting in shutdown of the system and loss of data.

1. Follow the safety guidelines listed in the [Safety instructions](#).
2. Follow the procedure listed in [Before working inside your system](#).

Steps

Press the edges and lift the air shroud out of the rear drive module.

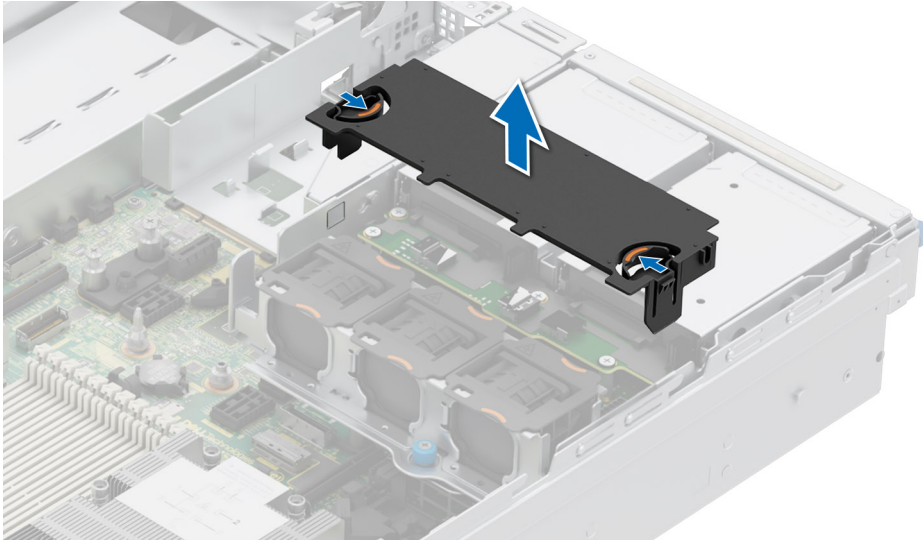

Figure 41. Removing the 4 x 2.5-inch rear drive module air shroud

Next steps

1. [Replace the 4 x 2.5-inch rear drive module air shroud](#).

Installing the 4 x 2.5-inch rear drive module air shroud

Prerequisites

1. Follow the safety guidelines listed in the [Safety instructions](#).
2. Follow the procedure listed in [Before working inside your system](#).

Steps

1. Align the tabs on the air shroud with the slots on the rear drive module.
2. Lower the air shroud into the rear drive module until it is firmly seated.

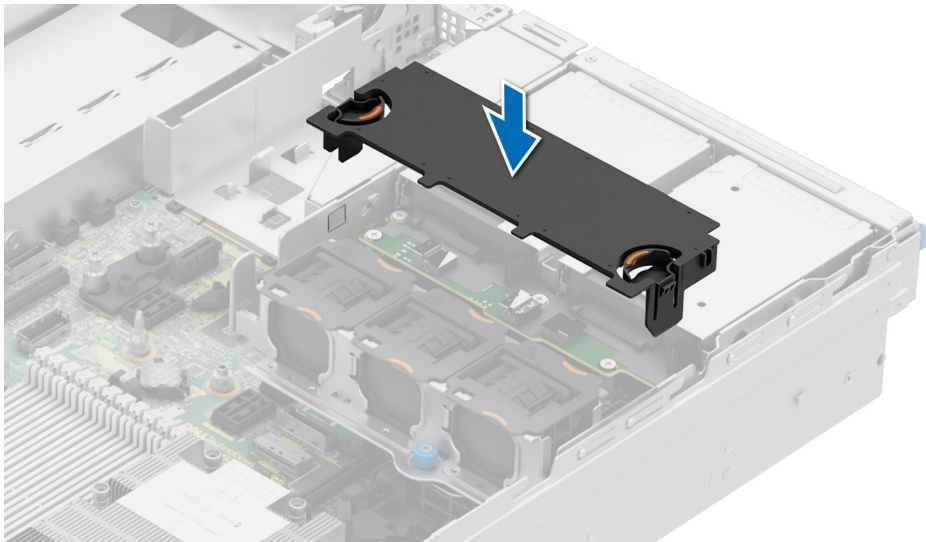

Figure 42. Installing the 4 x 2.5-inch rear drive module air shroud

Next steps

1. Follow the procedure listed in [After working inside your system](#).

Cooling fan

Removing the cooling fan cage assembly

Prerequisites

1. Follow the safety guidelines listed in the [Safety instructions](#).
2. Follow the procedure listed in the [Before working inside your system](#).
3. If installed, [remove the air shroud](#) or [remove the GPU air shroud](#).

Steps

1. Lift the blue release levers to unlock the cooling fan cage assembly from the system.
2. Hold the release levers, and lift the cooling fan cage assembly away from the system.

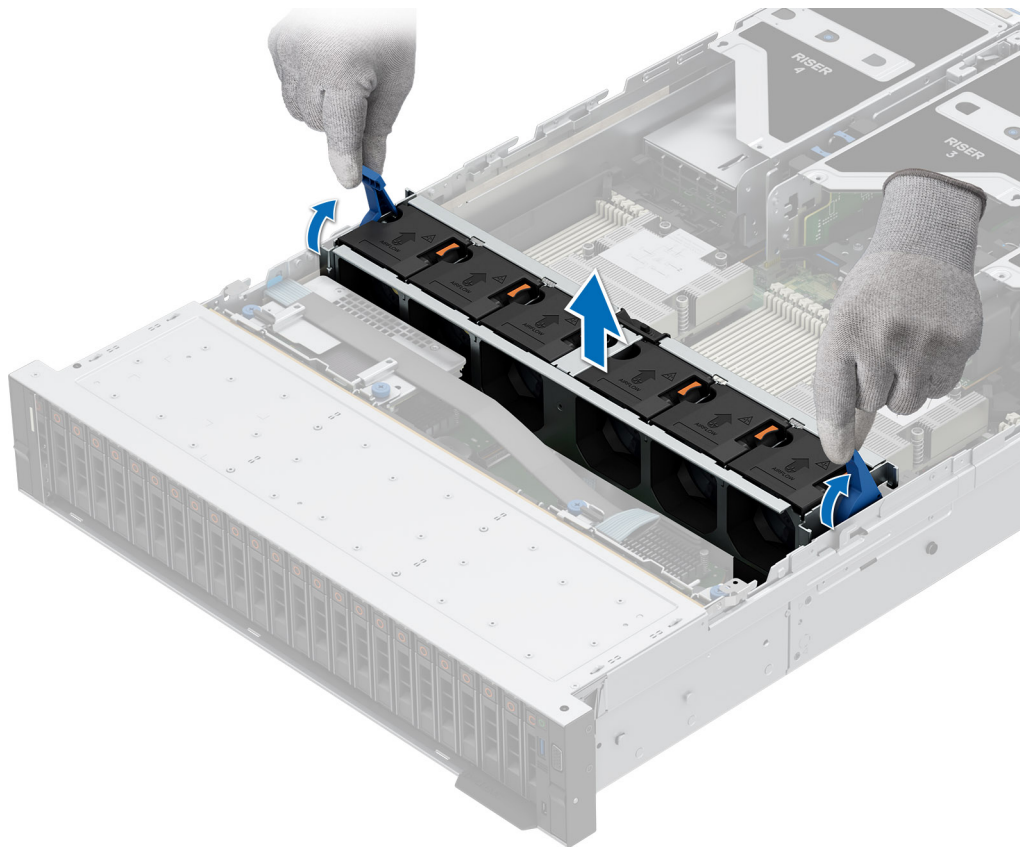

Figure 43. Removing the cooling fan cage assembly

Next steps

1. [Install the cooling fan cage assembly.](#)

Installing the cooling fan cage assembly

Prerequisites

1. Follow the safety guidelines listed in the [Safety instructions](#).
CAUTION: Ensure that the cables inside the system are correctly installed and retained by the cable retention bracket before installing the cooling fan cage assembly. Incorrectly installed cables may get damaged.
2. Follow the procedure listed in [Before working inside your system](#).
3. If installed, [remove the air shroud](#) or [remove the GPU air shroud](#).

Steps

1. Align the guide rails on the cooling fan cage assembly with the standoffs on the system.
2. Lower the cooling fan cage assembly into the system until the cooling fan cage connectors engage with the connectors on the system board.
3. Press the release levers to lock the cooling fan cage assembly into the system.

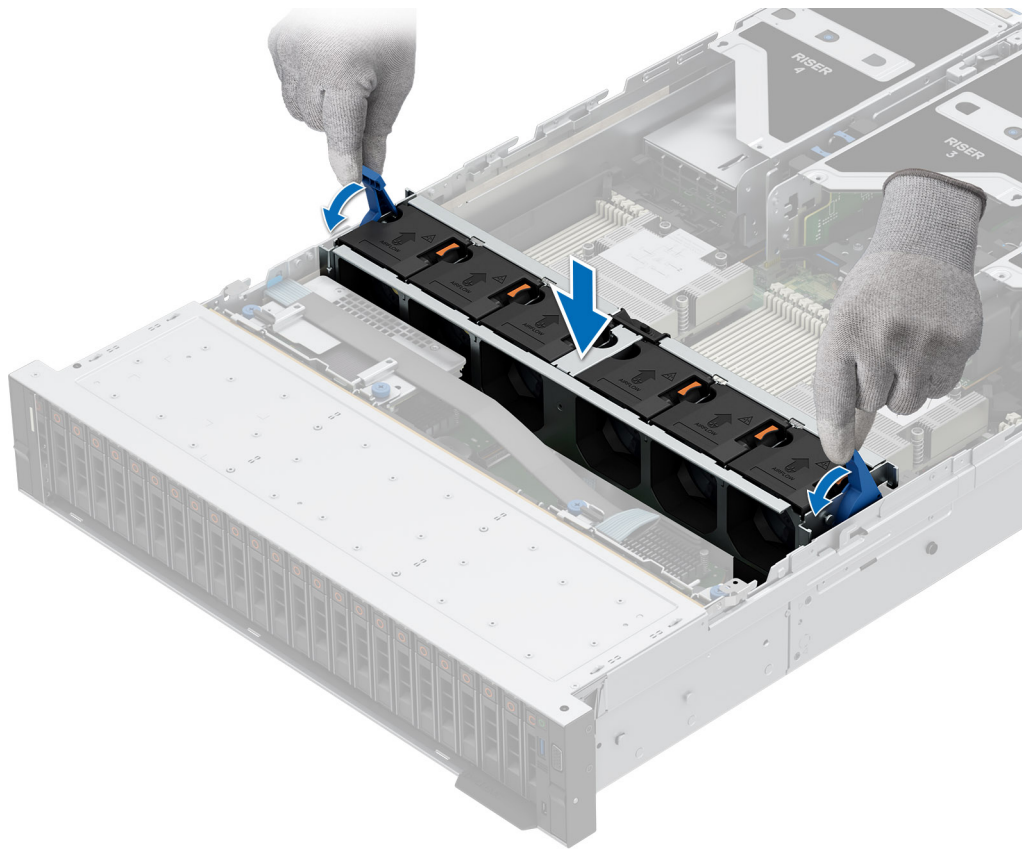

Figure 44. Installing the cooling fan cage assembly

Next steps

1. If removed, [install the air shroud](#) or [install the GPU air shroud](#).
2. Follow the procedure listed in [After working inside your system](#).

Removing a cooling fan

Prerequisites

1. Follow the safety guidelines listed in the [Safety instructions](#).
2. Follow the procedure listed in [Before working inside your system](#).
3. If installed, [remove the air shroud](#) or [remove the GPU air shroud](#).

Steps

Press the orange release tab and lift the cooling fan to disconnect the fan from the connector on the system board.

NOTE: The procedure to remove high-performance (silver grade), or high-performance (gold grade) fan is same.

WARNING: Ensure not to tilt or rotate the cooling fan while removing from the system.

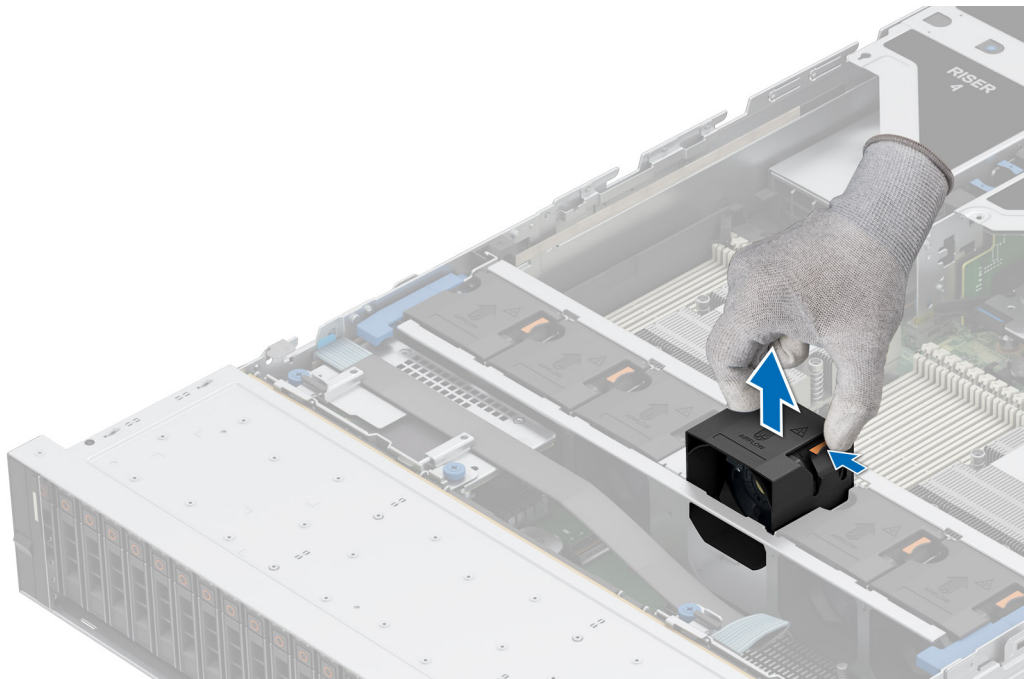

Figure 45. Removing a cooling fan

Next steps

1. [Replace a cooling fan.](#)

Installing a cooling fan

Prerequisites

1. Follow the safety guidelines listed in the [Safety instructions](#).
2. Follow the procedure listed in [Before working inside your system](#).

Steps

Align and slide the cooling fan into the cooling fan assembly until the fan clicks into place.

i **NOTE:** The procedure to install high-performance (silver grade), or high-performance (gold grade) fan is same.

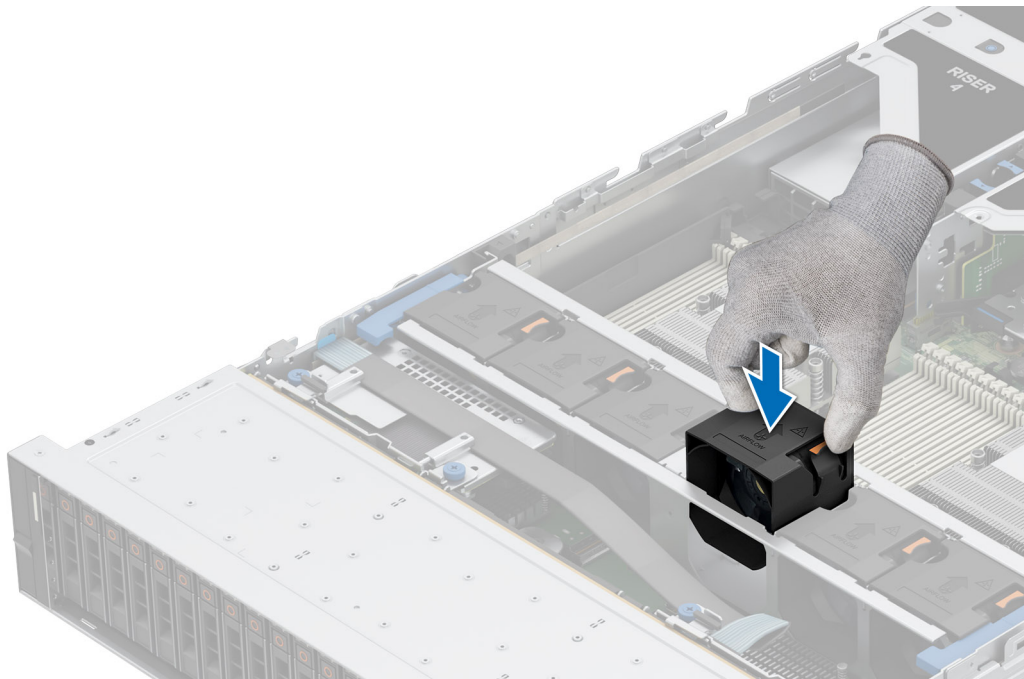

Figure 46. Installing a cooling fan

Next steps

1. If removed, [install the air shroud](#) or [install the GPU air shroud](#).
2. Follow the procedure listed in [After working inside your system](#).

Removing a 2 x 2.5-inch rear drive module cooling fan

Prerequisites

1. Follow the safety guidelines listed in the [Safety instructions](#).
2. Follow the procedure listed in [Before working inside your system](#).
3. [Remove the 2 x 2.5-inch rear drive module air shroud](#).

Steps

Press the orange release tab and lift the rear drive module cooling fan to disconnect from the connector on the rear drive module.

⚠️ WARNING: Ensure not to tilt or rotate the cooling fan while removing from the rear drive module.

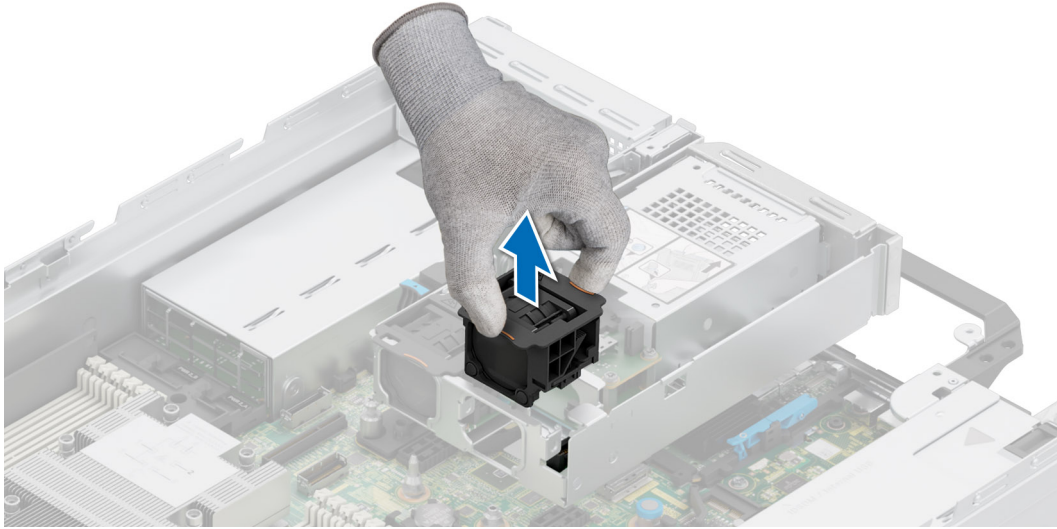

Figure 47. Removing a 2 x 2.5-inch rear drive module cooling fan

Next steps

1. [Replace 2 x 2.5-inch rear drive module cooling fan.](#)

Installing a 2 x 2.5-inch rear drive module cooling fan

Prerequisites

1. Follow the safety guidelines listed in the [Safety instructions](#).
2. Follow the procedure listed in [Before working inside your system](#).
3. [Remove the 2 x 2.5-inch rear drive module air shroud.](#)

Steps

Align and lower the rear drive module cooling fan into the rear drive module until the fan clicks into place.

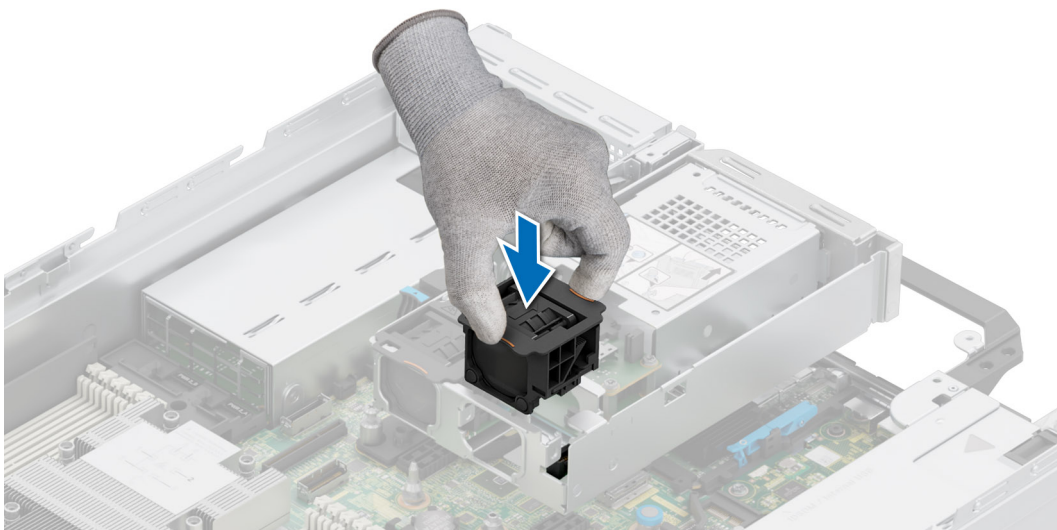

Figure 48. Installing a 2 x 2.5-inch rear drive module cooling fan

Next steps

1. [Install the 2 x 2.5-inch rear drive module air shroud.](#)
2. Follow the procedure listed in [After working inside your system.](#)

Removing a 4 x 2.5-inch rear drive module cooling fan

Prerequisites

1. Follow the safety guidelines listed in the [Safety instructions.](#)
2. Follow the procedure listed in [Before working inside your system.](#)
3. [Remove the 4 x 2.5-inch rear drive module air shroud.](#)

Steps

Press the orange release tab and lift the rear drive module cooling fan to disconnect from the connector on the rear drive module.

⚠️ WARNING: Ensure not to tilt or rotate the cooling fan while removing from the rear drive module.

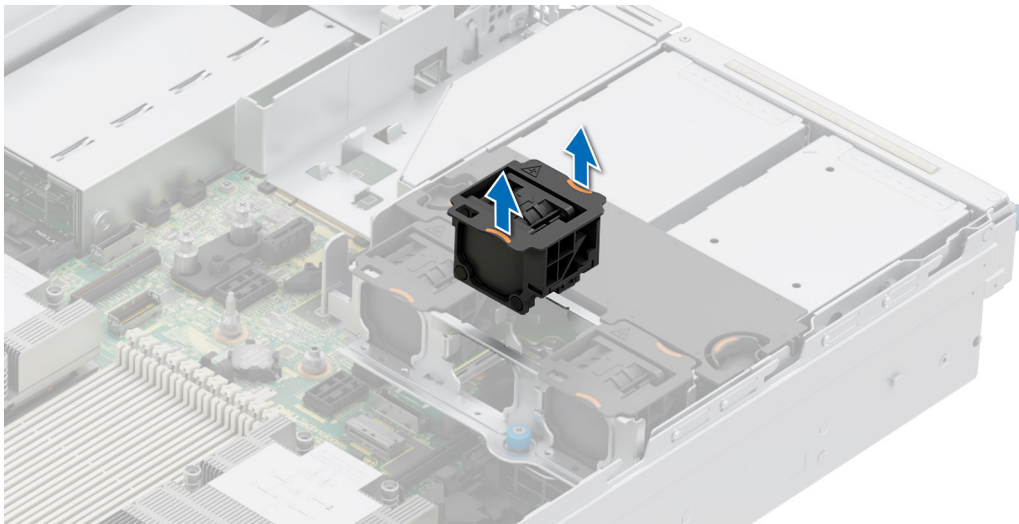

Figure 49. Removing a 4 x 2.5-inch rear drive module cooling fan

Next steps

1. [Replace 4 x 2.5-inch rear drive module cooling fan.](#)

Installing a 4 x 2.5-inch rear drive module cooling fan

Prerequisites

1. Follow the safety guidelines listed in the [Safety instructions.](#)
2. Follow the procedure listed in [Before working inside your system.](#)
3. [Remove the 4 x 2.5-inch rear drive module air shroud.](#)

Steps

Align and lower the rear drive module cooling fan into the rear drive module until the fan clicks into place.

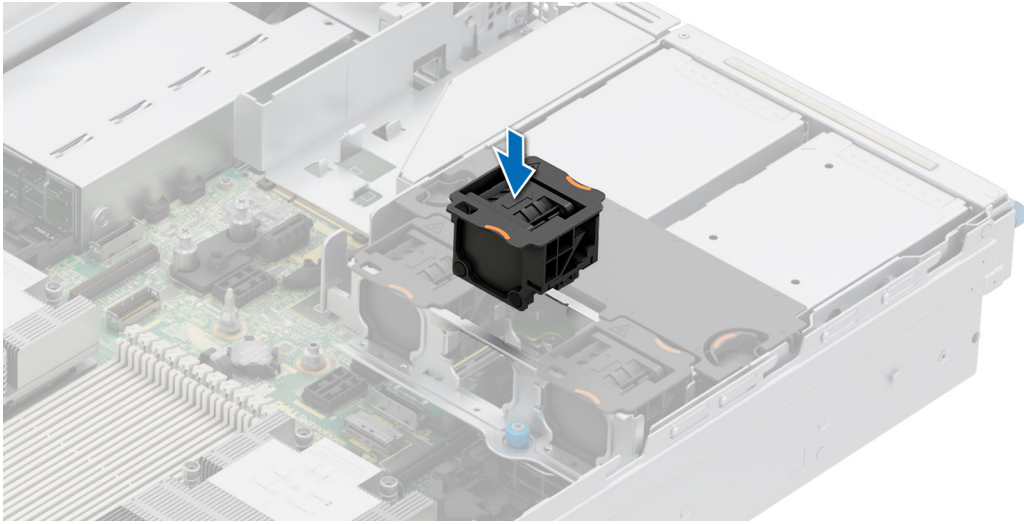

Figure 50. Installing a 4 x 2.5-inch rear drive module cooling fan

Next steps

1. Install the 4 x 2.5-inch rear drive module air shroud.
2. Follow the procedure listed in [After working inside your system](#).

Drives

Removing a drive blank

Prerequisites

1. Follow the safety guidelines listed in the [Safety instructions](#).
2. If installed, [remove the front bezel](#).

CAUTION: To maintain proper system cooling, drive blanks must be installed in all empty drive slots.

Steps

Press the release button, and slide the drive blank out of the drive slot.

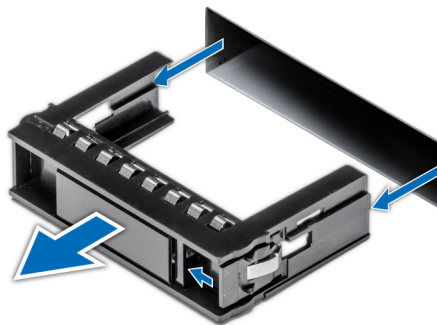

Figure 51. Removing a drive blank

Next steps

1. Replace the drive blank.

Installing a drive blank

Prerequisites

1. Follow the safety guidelines listed in the [Safety instructions](#).
2. If installed, [remove the front bezel](#).

Steps

Insert the drive blank into the drive slot until the release button clicks into place.

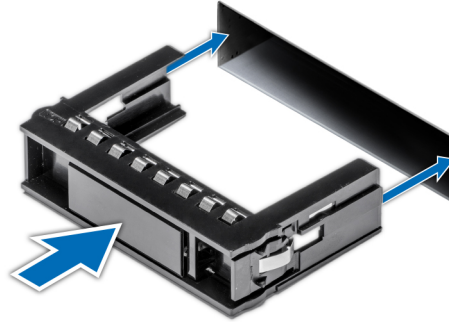

Figure 52. Installing a drive blank

Next steps

1. If removed, [install the front bezel](#).

Removing the drive carrier

Prerequisites

1. Follow the safety guidelines listed in the [Safety instructions](#).
2. If installed, [remove the front bezel](#).
3. Using the management software, prepare the drive for removal.

i **NOTE:** If the drive is online, the green activity or fault indicator blinks while the drive is powering off. When the drive indicators are off, the drive is ready for removal. For more information, see the documentation for the storage controller.

⚠ **CAUTION:** Before attempting to remove or install a drive while the system is running, see the documentation for the storage controller card to ensure that the host adapter is configured correctly to support drive removal and insertion.

⚠ **CAUTION:** To prevent data loss, ensure that your operating system supports drive installation. For more information about the drives installation or uninstallation requirements, see the operating system's user guide.

Steps

1. Press the release button to open the drive carrier release handle.
2. Holding the drive carrier release handle, slide the drive carrier out of the drive slot.



Figure 53. Removing a drive carrier

Next steps

1. Install a drive carrier or drive blank.

Installing the drive carrier

Prerequisites

- ⚠ **CAUTION:** Before removing or installing a drive while the system is running, see the documentation for the storage controller card to ensure that the host adapter is configured correctly to support drive removal and insertion.
 - ⚠ **CAUTION:** Combining SAS and SATA drives in the same RAID volume is not supported.
 - ⚠ **CAUTION:** When installing a drive, ensure that the adjacent drives are fully installed. Inserting a drive carrier and attempting to lock its handle next to a partially installed carrier can damage the partially installed carrier's shield spring and make it unusable.
 - ⚠ **CAUTION:** To prevent data loss, ensure that your operating system supports hot-swap drive installation. See the documentation supplied with your operating system.
 - ℹ **NOTE:** When a replacement hot swappable drive is installed while the system is powered on, the drive automatically begins to rebuild. Ensure that the replacement drive is blank. Any data on the replacement drive is immediately lost once the drive is installed.
 - ℹ **NOTE:** Ensure that the drive carrier's release handle is in the open position before inserting the carrier into the slot.
1. Follow the safety guidelines listed in the [Safety instructions](#).
 2. If installed, [remove the front bezel](#).
 3. Remove the drive carrier or remove the drive blank when you want to assemble the drives in to the system.

Steps

1. Slide the drive carrier into the drive slot.
2. Close the drive carrier release handle to lock the drive in place.



Figure 54. Installing a drive carrier

Next steps

If removed, [install the front bezel](#).

Removing the drive from the drive carrier

Prerequisites

1. Follow the safety guidelines listed in the [Safety instructions](#).
2. If installed, [remove the front bezel](#).

Steps

1. Using a Phillips #1 screwdriver, remove the screws from the slide rails on the drive carrier.

i **NOTE:** If the hard drive or SSD carrier has Torx screw, use Torx 6 (for 2.5-inch drive) or Torx 8 (for 3.5-inch drive) screwdriver to remove the drive.



2. Lift the drive out of the drive carrier.

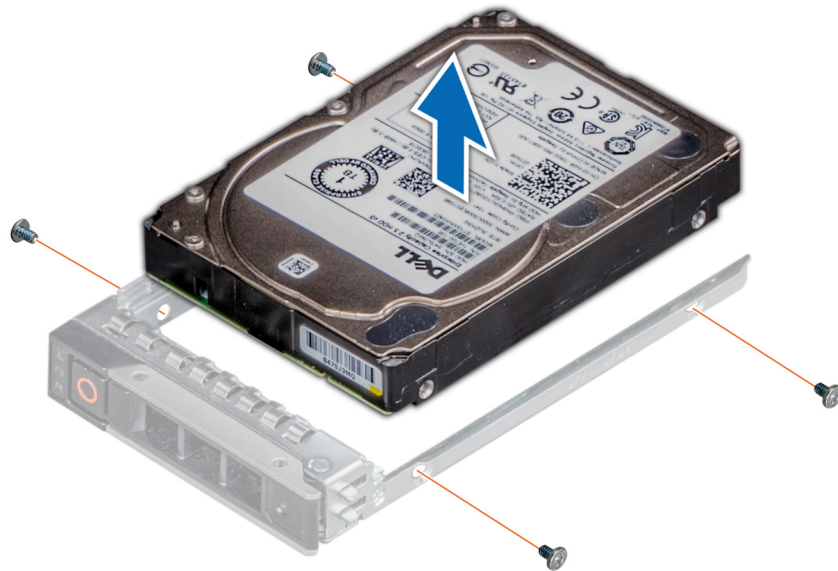

Figure 55. Removing the drive from the drive carrier

Next steps

Install the drive into the drive carrier.

Installing the drive into the drive carrier

Prerequisites

1. Follow the safety guidelines listed in the [Safety instructions](#).
2. If installed, [remove the front bezel](#).
3. [Remove the drive blank](#).

Steps

1. Insert the drive into the drive carrier with the drive connector facing towards the rear of the carrier.
2. Align the screw holes on the drive with the screws holes on the drive carrier.
3. Using a Phillips #1 screwdriver, secure the drive to the drive carrier with the screws.

NOTE: When installing a drive into the drive carrier, ensure that the screws are torqued to 4 lbf-in.

NOTE: If the hard drive or SSD carrier has Torx screw, use Torx 6 (for 2.5-inch drive) or Torx 8 (for 3.5-inch drive) screwdriver to install the drive.





Figure 56. Installing a drive into the drive carrier

Next steps

1. [Install the drive carrier.](#)
2. If removed, [install the front bezel.](#)

Rear drive module

Removing the 2 x 2.5-inch rear drive module

Prerequisites

1. Follow the safety guidelines listed in [Safety instructions.](#)
2. Follow the procedure listed in [Before working inside your system.](#)
3. If required, [remove the air shroud.](#)
4. [Remove the drives.](#)
5. Disconnect the cables from the rear drive module.

i **NOTE:** Refer [cable routing](#) topic for more information.

Steps

1. Using a Phillips #2 screwdriver, loosen the captive screws that secure the rear drive module to the system.
2. Press the blue release tab and holding the edges lift the rear drive module away from the system.

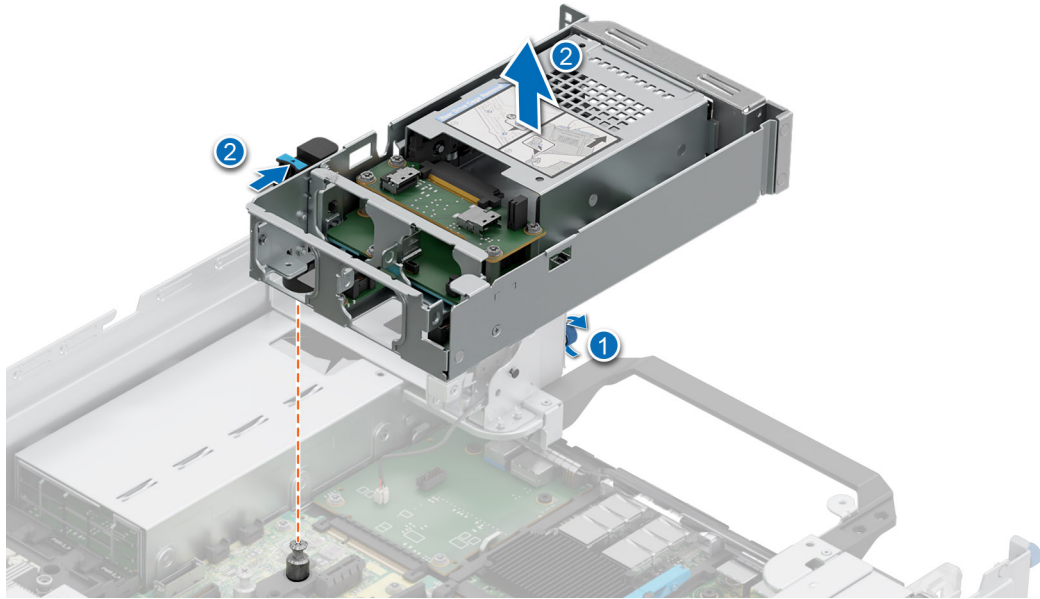

Figure 57. Removing the 2x 2.5-inch rear drive module

Next steps

1. [Replace the 2 x 2.5-inch rear drive module.](#)

Installing the 2 x 2.5-inch rear drive module

Prerequisites

1. Follow the safety guidelines listed in [Safety instructions](#).
2. Follow the procedure listed in [Before working inside your system](#).
3. If required, [remove the air shroud](#).
4. [Remove the drives](#).
5. Disconnect the cables from the rear drive module.

i **NOTE:** Refer [cable routing](#) topic for more information.

Steps

1. Align the slot on the rear drive module with the guide on the system.
2. Lower and press the rear drive module on top of the riser until firmly seated.
3. Using a Phillips #2 screwdriver, tighten the captive screws that secure the rear drive module into the system.

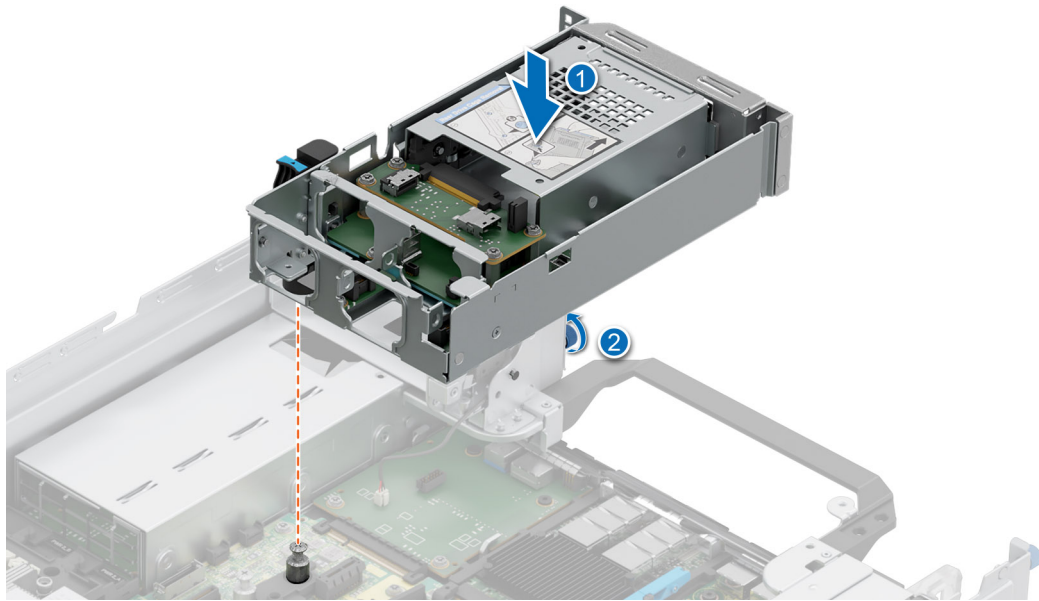

Figure 58. Installing the 2 x 2.5-inch rear drive module

Next steps

1. Connect and route all the cables to the rear drive module.
2. [Install the drives.](#)
3. If removed, [install the air shroud.](#)
4. Follow the procedure listed in [After working inside your system.](#)

Removing the 4 x 2.5-inch rear drive module

Prerequisites

1. Follow the safety guidelines listed in [Safety instructions.](#)
2. Follow the procedure listed in [Before working inside your system.](#)
3. If required, [remove the air shroud.](#)
4. [Remove the drives.](#)
5. **NOTE:** If BOSS-N1 module is installed, ensure to disconnect the BOSS-N1 power cable and Signal cable before removing the 4 x 2.5-inch rear drive module.

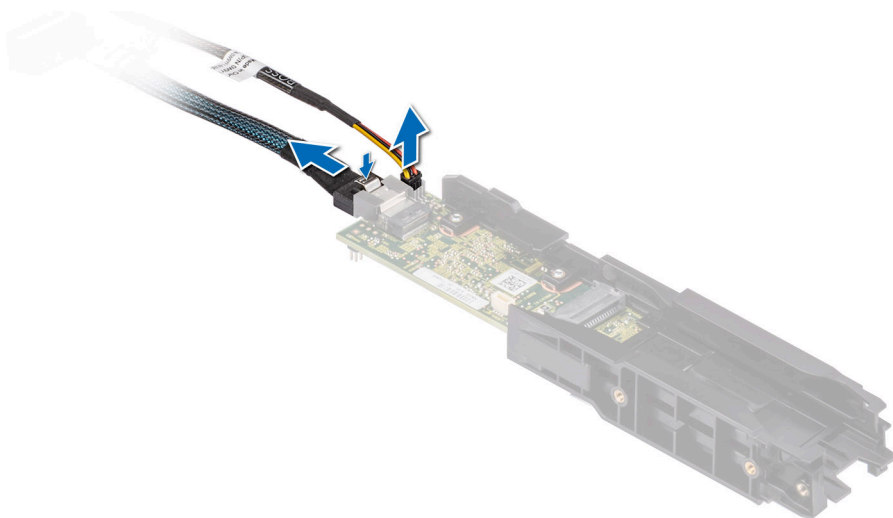

6. Disconnect the cables from the rear drive module.

NOTE: Refer [cable routing](#) topic for more information.

Steps

1. Using a Phillips #2 screwdriver, loosen the captive screws that secure the rear drive module to the system.
2. Lift the rear drive module from the system.

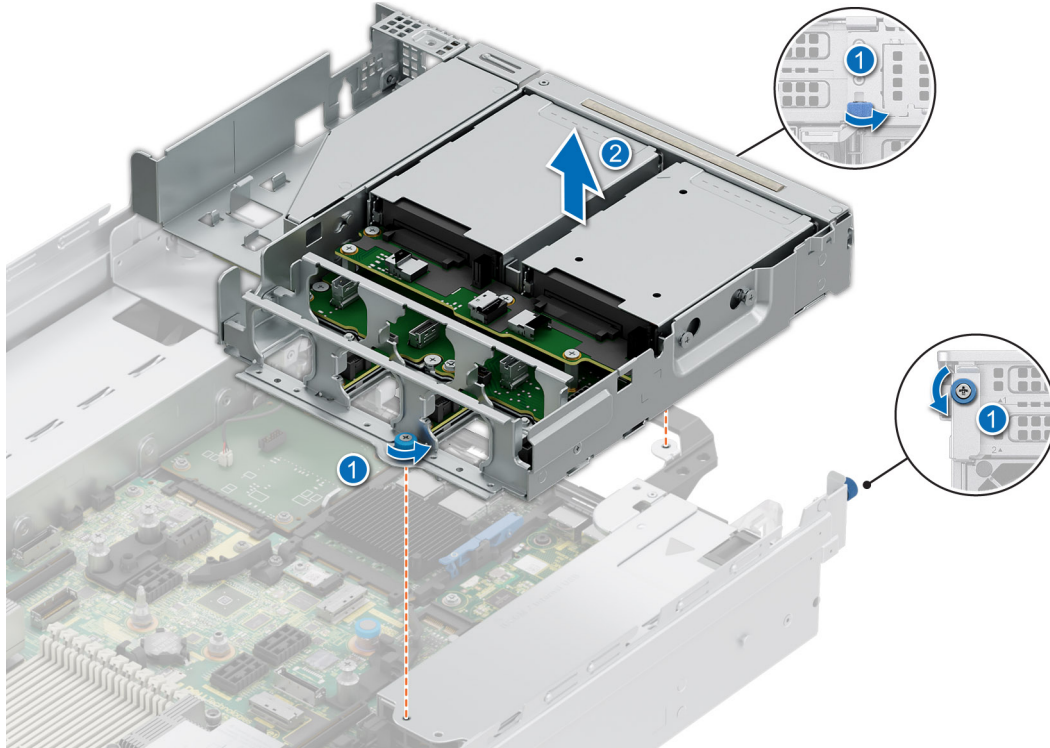

Figure 59. Removing the 4 x 2.5-inch rear drive module

Next steps

1. [Replace the 4 x 2.5-inch rear drive module.](#)

Installing the 4 x 2.5-inch rear drive module

Prerequisites

1. Follow the safety guidelines listed in [Safety instructions](#).
2. Follow the procedure listed in [Before working inside your system](#).
3. If required, [remove the air shroud](#).
4. [Remove the drives](#).
5. If installed, [remove the BOSS-N1 module](#).
6. Disconnect the cables from the rear drive module.

NOTE: Refer [cable routing](#) topic for more information.

Steps

1. Align and lower the rear drive module with the guide on the system.
2. Using a Phillips #2 screwdriver, tighten the captive screws that secure the rear drive module into the system.

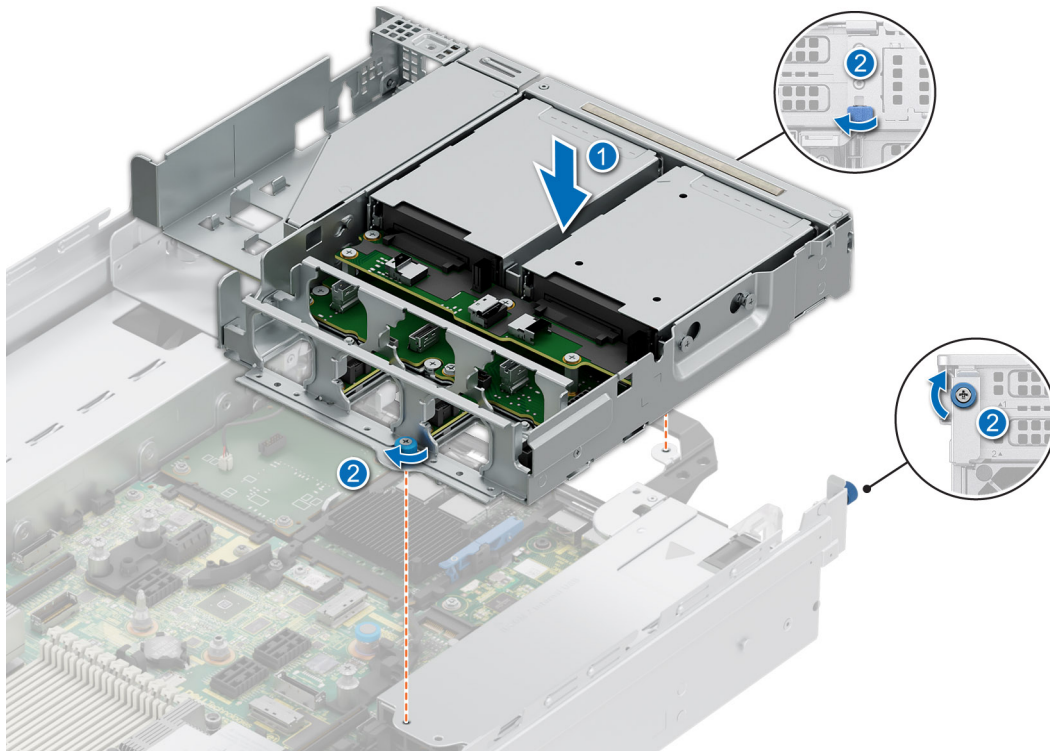

Figure 60. Installing the 4 x 2.5-inch rear drive module

Next steps

1. Connect and route all the cables to the rear drive module.
2. [Install the drives.](#)
3. If removed, [install the BOSS-N1 module.](#)
4. If removed, [install the air shroud.](#)
5. Follow the procedure listed in [After working inside your system.](#)

Drive backplane

Drive backplane

Depending on your system configuration, the drive backplanes that are supported are listed here:

Table 72. Supported backplane options

System	Supported hard drives options
PowerEdge R7625	2.5-inch (x 8) NVMe backplane
	2.5-inch (x 8) SAS, or SATA backplane
	3.5-inch (x 8) SAS, or SATA backplane
	3.5-inch (x 12) SAS or SATA backplane
	2.5-inch (x 24) SAS, SATA, or NVMe backplane

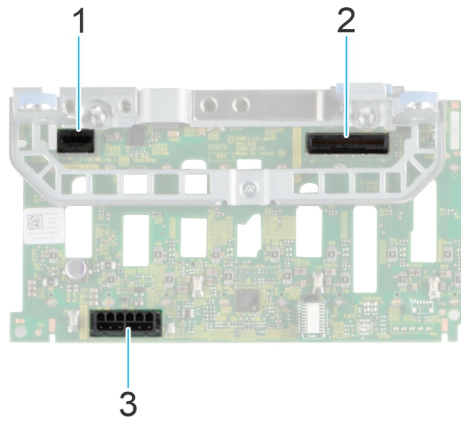

Figure 61. 8 x 2.5-inch NVMe drive backplane

1. BP_PWR_CTRL
2. BP_DST_SA1 (PERC to backplane)
3. BP_PWR_1 (backplane power and signal cable to system board)

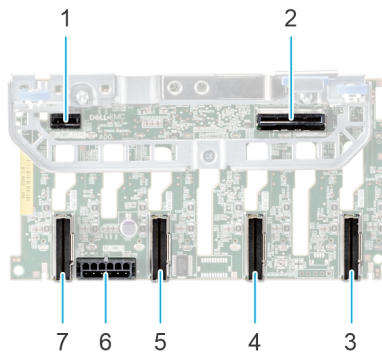

Figure 62. 8 x 2.5-inch drive backplane

- | | |
|---|--|
| <ol style="list-style-type: none"> 1. BP_PWR_CTRL 3. BP_DST_PA1 (PCIe/NVMe connector) 5. BP_DST_PA2 (PCIe/NVMe connector) 7. BP_DST_PB2 (PCIe/NVMe connector) | <ol style="list-style-type: none"> 2. BP_DST_SA1 (PERC to backplane) 4. BP_DST_PB1 (PCIe/NVMe connector) 6. BP_PWR_1 (backplane power and signal cable to system board) |
|---|--|

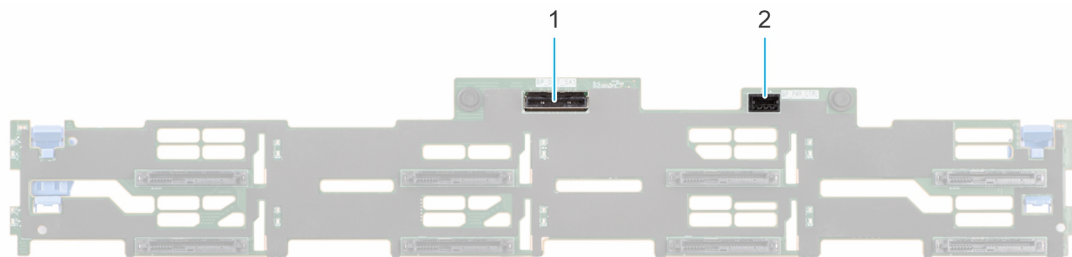

Figure 63. 8 x 3.5-inch drive backplane rear

1. BP_DST_SA1 (PERC to backplane)
2. BP_PWR_CTRL

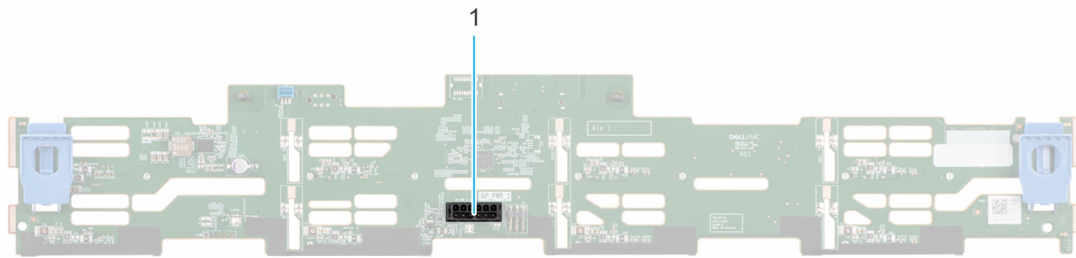

Figure 64. 8 x 3.5-inch drive backplane front

1. BP_PWR_1 (backplane power and signal cable to system board)

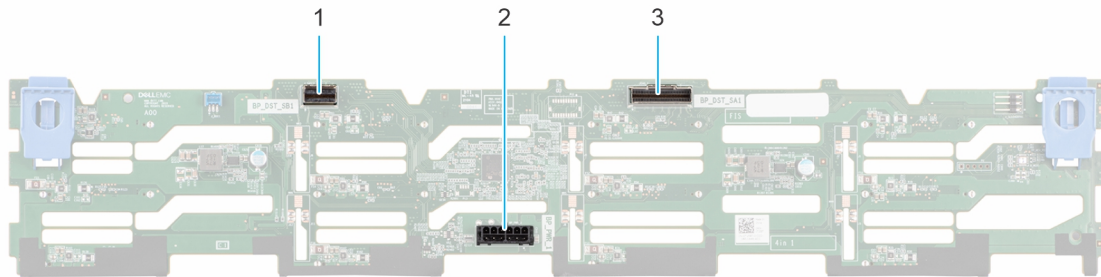

Figure 65. 12 x 3.5-inch drive backplane

1. BP_DST_SB1
2. BP_PWR_1 (backplane power and signal cable to system board)
3. BP_DST_SA1

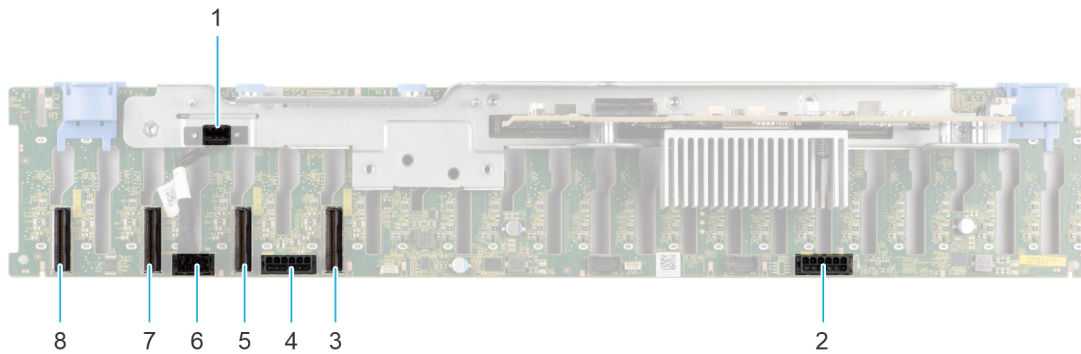

Figure 66. 24 x 2.5-inch drive backplane (front view)

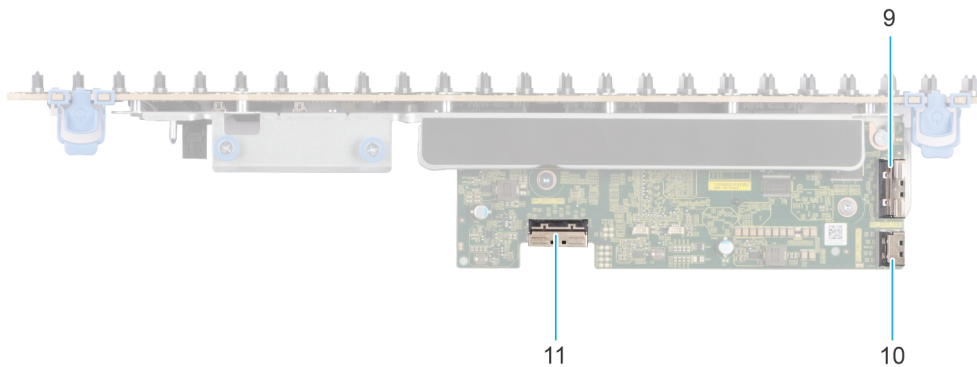

Figure 67. 24 x 2.5-inch drive backplane (top view)

1. BP_CTRL
2. BP_PWR_1 (backplane power and signal cable to system board)

3. BP_DST_PA1 (PCIe/NVMe connector)
5. BP_DST_PB1 (PCIe/NVMe connector)
7. BP_DST_PA2 (PCIe/NVMe connector)
9. BP_DST_SB1
11. BP_DST_SA1
4. BP_PWR_2 (backplane power and signal cable to system board)
6. BP_PWR_CTRL
8. BP_DST_PB2 (PCIe/NVMe connector)
10. BP_SRC_SA2

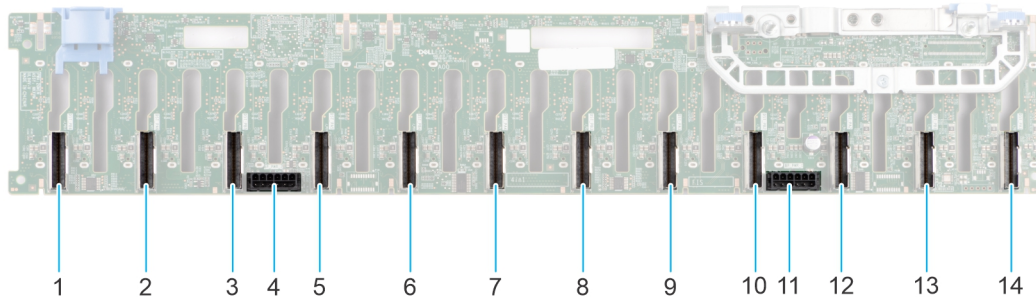

Figure 68. 24 x 2.5-inch NVMe passive backplane

1. BP_DST_PB6 (PCIe/NVMe connector)
3. BP_DST_PB5 (PCIe/NVMe connector)
5. BP_DST_PA5 (PCIe/NVMe connector)
7. BP_DST_PA4 (PCIe/NVMe connector)
9. BP_DST_PA3 (PCIe/NVMe connector)
11. BP_PWR_1
13. BP_DST_PB1 (PCIe/NVMe connector)
2. BP_DST_PA6 (PCIe/NVMe connector)
4. BP_PWR_2
6. BP_DST_PB4 (PCIe/NVMe connector)
8. BP_DST_PB3 (PCIe/NVMe connector)
10. BP_DST_PB2 (PCIe/NVMe connector)
12. BP_DST_PA2 (PCIe/NVMe connector)
14. BP_DST_PA1 (PCIe/NVMe connector)

Removing the drive backplane

Prerequisites

CAUTION: To prevent damage to the drives and backplane, remove the drives from the system before removing the backplane.

CAUTION: Note the number of each drive and temporarily label them before you remove the drive so that you can reinstall them in the same location.

NOTE: The procedure to remove the backplane is similar for all backplane configurations.

1. Follow the safety guidelines listed in the [Safety instructions](#).
2. Follow the procedure listed in the [Before working inside your system](#).
3. [Remove the backplane cover](#).
4. If installed, [remove the air shroud](#) or [remove the GPU air shroud](#).
5. [Remove all the drives](#).
6. [Remove the cooling fan cage assembly](#).
7. Observe and disconnect the drive backplane cables from the connector on the system board and backplane.

NOTE: Refer [cable routing](#) topic for more information.

Steps

1. Press the blue release tabs to disengage the drive backplane from the hooks on the system.
2. Lift and pull the drive backplane out of the system.

NOTE: To avoid damaging the backplane, ensure that you move the control panel cables from the cable routing clips before removing the backplane.

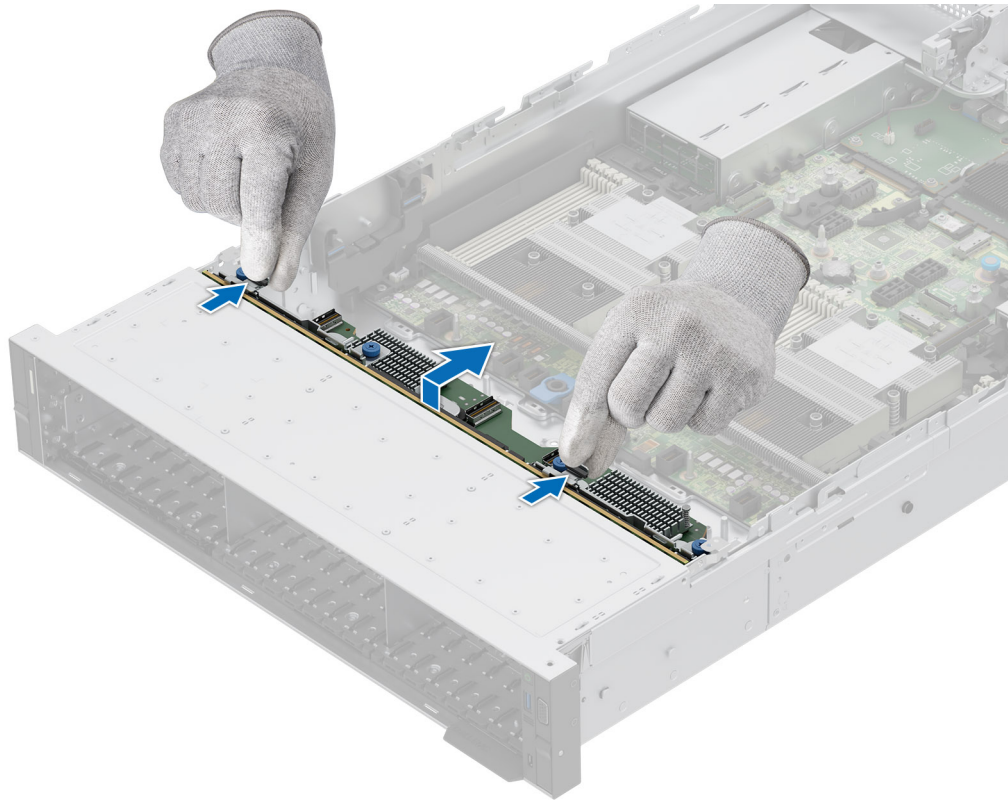

Figure 69. Removing the drive backplane

Next steps

1. [Replace the drive backplane.](#)

Installing the drive backplane

Prerequisites

1. Follow the safety guidelines listed in the [Safety instructions](#).
2. Follow the procedure listed in the [Before working inside your system](#).
3. [Remove the backplane cover](#).
4. If installed, [remove the air shroud](#) or [remove the GPU air shroud](#).
5. [Remove all the drives](#).
6. [Remove the cooling fan cage assembly](#).
7. Observe and disconnect the drive backplane cables from the connector on the system board and backplane.

NOTE: Refer [cable routing](#) topic for more information.

NOTE: To avoid damaging the backplane, ensure to move the control panel cables from the cable routing clips before removing the backplane.

NOTE: Route the cable properly when you replace it to prevent the cable from being pinched or crimped.

Steps

1. Use the guides on the system as guides to align the slots on the backplane.
2. Insert the backplane into the guides and lower the backplane until the blue release tabs clicks into place.

3. Route the cables properly through the cable guide and connect the cables to the connector on the system board.

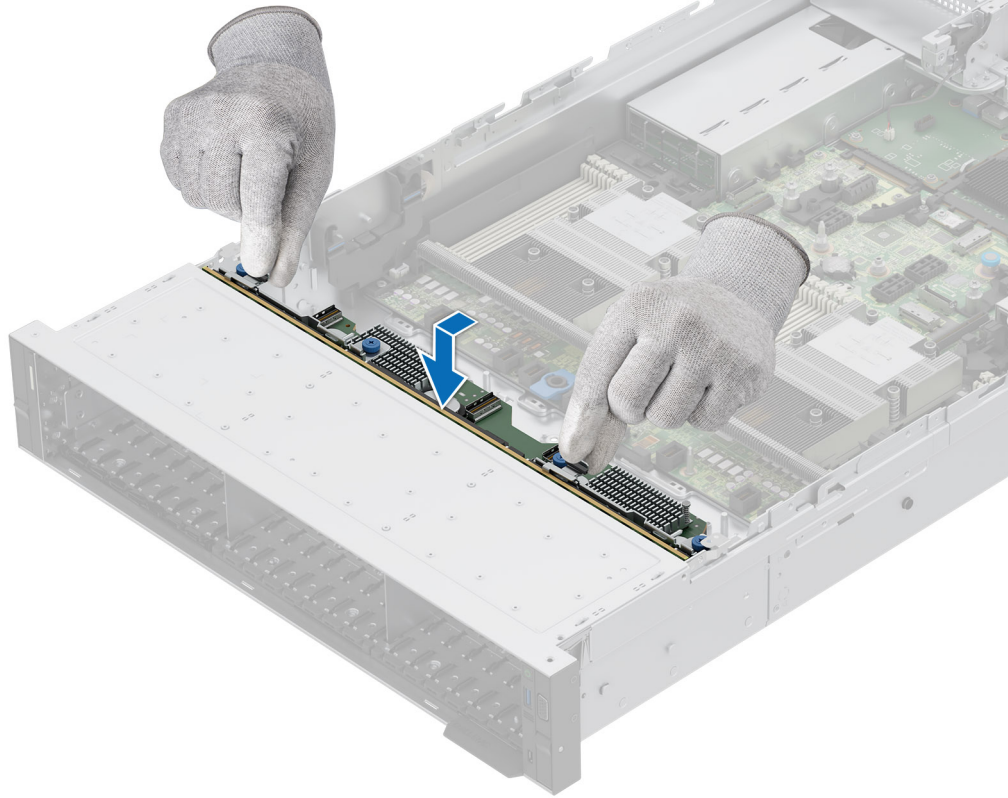

Figure 70. Installing the drive backplane

Next steps

1. [Install the cooling fan cage assembly.](#)
2. [Install all the drives.](#)
3. If removed, [install the air shroud](#) or [install the GPU air shroud.](#)
4. [Install the drive backplane cover.](#)
5. Connect the drive backplane cables to the connector on the system board.
6. Connect the drive backplane cables to the connector on the backplane.
7. Follow the procedure listed in [After working inside your system.](#)

Side wall brackets

Removing the side wall bracket

Prerequisites

1. Follow the safety guidelines listed in the [Safety instructions.](#)
2. Follow the procedure listed in the [Before working inside your system.](#)
3. [Remove the backplane cover.](#)
4. If installed, [remove the air shroud.](#)
5. [Remove the cooling fan assembly.](#)

i **NOTE:** Ensure that you note the routing of the cables as you remove them from the system board. Route the cable properly when you replace it to prevent the cable from being pinched or crimped.

Steps

1. Press the tab to release the side wall bracket cover.

NOTE: Unroute the cables to release them from the side wall bracket.

2. Release the bracket from the chassis, and lift it away from the system.

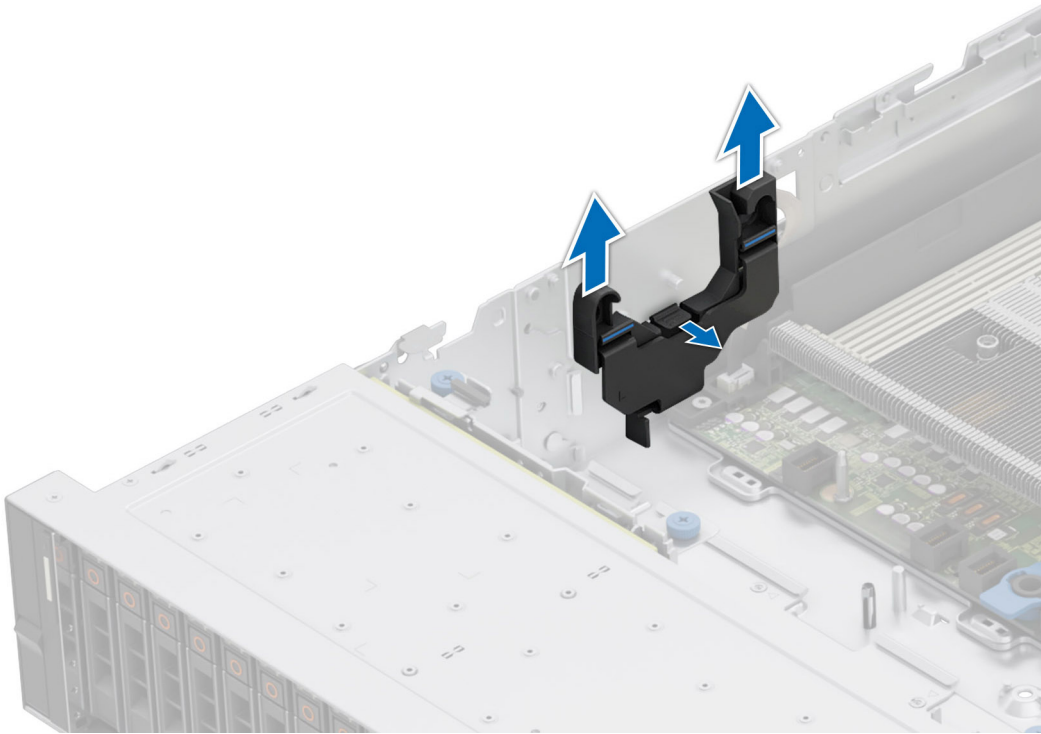

Figure 71. Removing the left side wall bracket

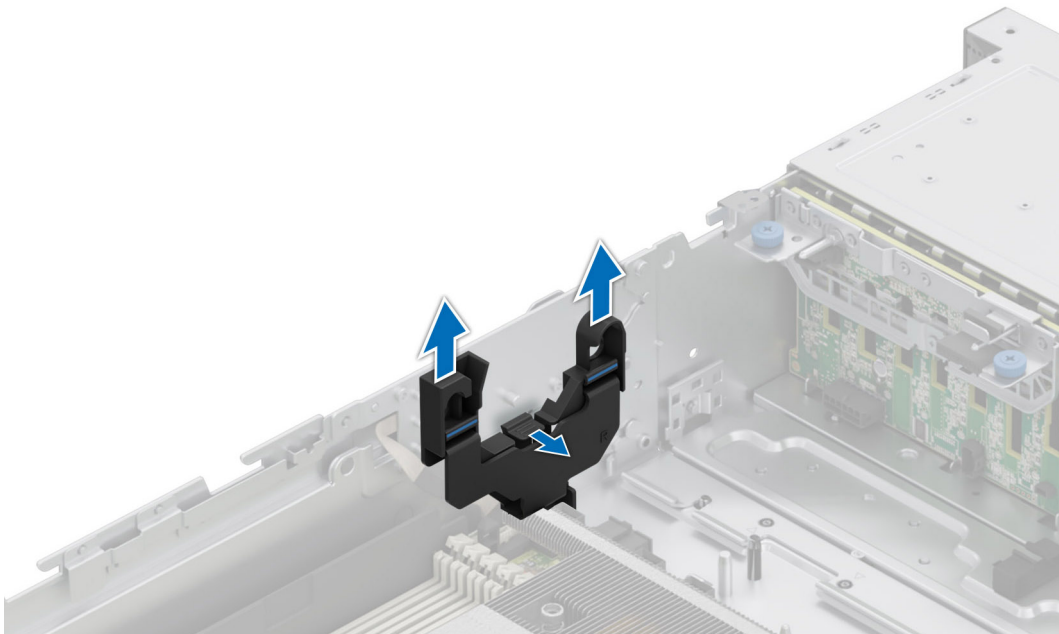

Figure 72. Removing the right side wall bracket

Next steps

1. Replace the side wall bracket.

Installing the side wall bracket

Prerequisites

1. Follow the safety guidelines listed in the [Safety instructions](#).
2. Follow the procedure listed in the [Before working inside your system](#).
3. [Remove the backplane cover](#).
4. If installed, [remove the air shroud](#).

i **NOTE:** Ensure that you note the routing of the cables as you remove them from the system board. Route the cable properly when you replace it to prevent the cable from being pinched or crimped.

Steps

1. Align the side wall bracket with the tabs on the chassis.
2. Press the side wall bracket with your thumbs until the bracket firmly clicks into place.

i **NOTE:** Route the cables through the side wall bracket.

3. Close the side wall bracket cover with your thumbs until the cover firmly clicks into place.

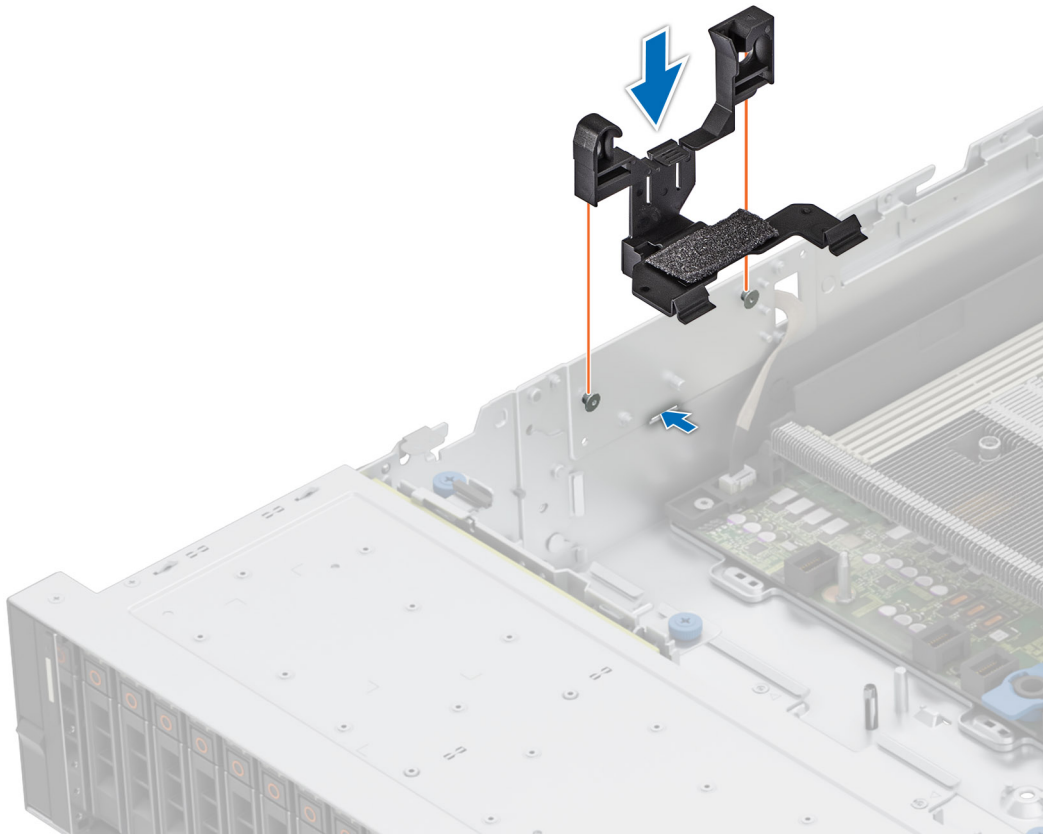

Figure 73. Installing the left side wall bracket

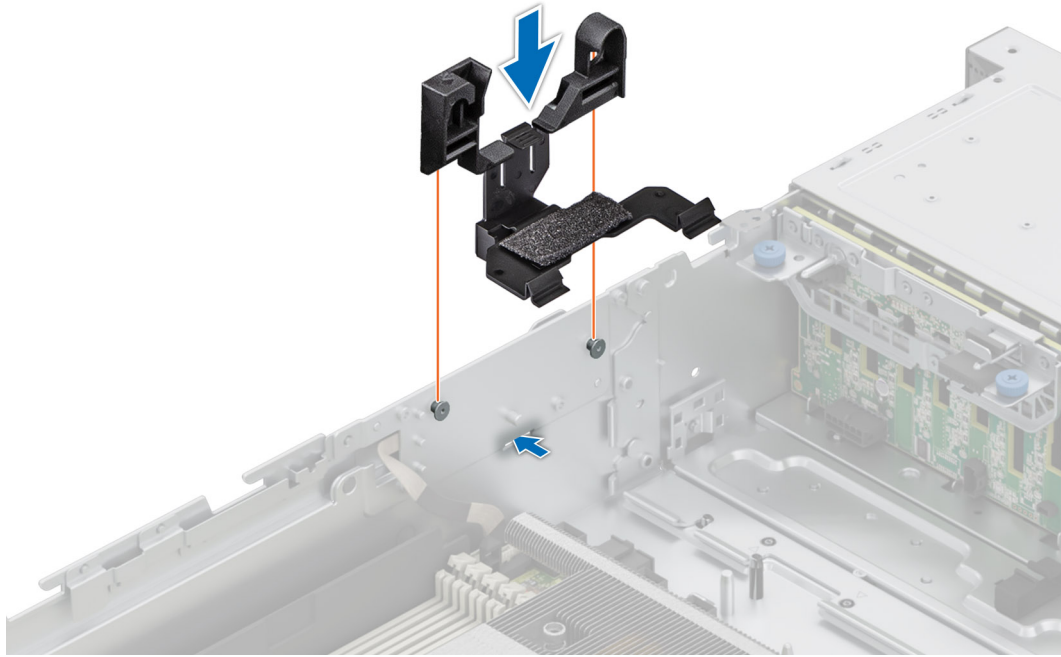

Figure 74. Installing the right side wall bracket

Next steps

1. [Replace the cooling fan assembly.](#)
2. If removed, [install the air shroud.](#)
3. [Install the backplane cover.](#)
4. If installed, [install the front bezel.](#)
5. Follow the procedure listed in the [After working inside your system.](#)

Cable routing

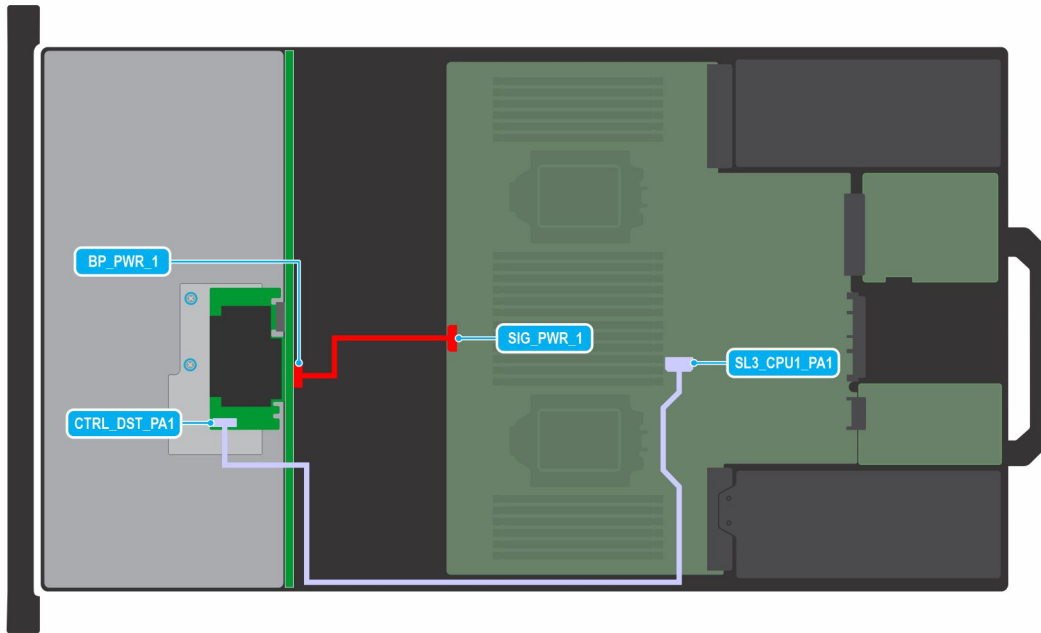

Figure 75. C-1: 8 x 3.5-inch SAS3/SATA RAID (w/ FPERC11)

NOTE: Follow the sequential order as shown in the table to remove the cables, to install the cables follow the reverse sequential order.

Table 73. 8 x 3.5-inch SAS3/SATA RAID (w/ FPERC11)

Order	From	To
1	SIG_PWR_1 (system board power connector)	BP_PWR_1 (backplane power connector)
2	SL3_CPU1_PA1 (signal connector on system board)	CTRL_DST_PA1 (fPERC input connector)

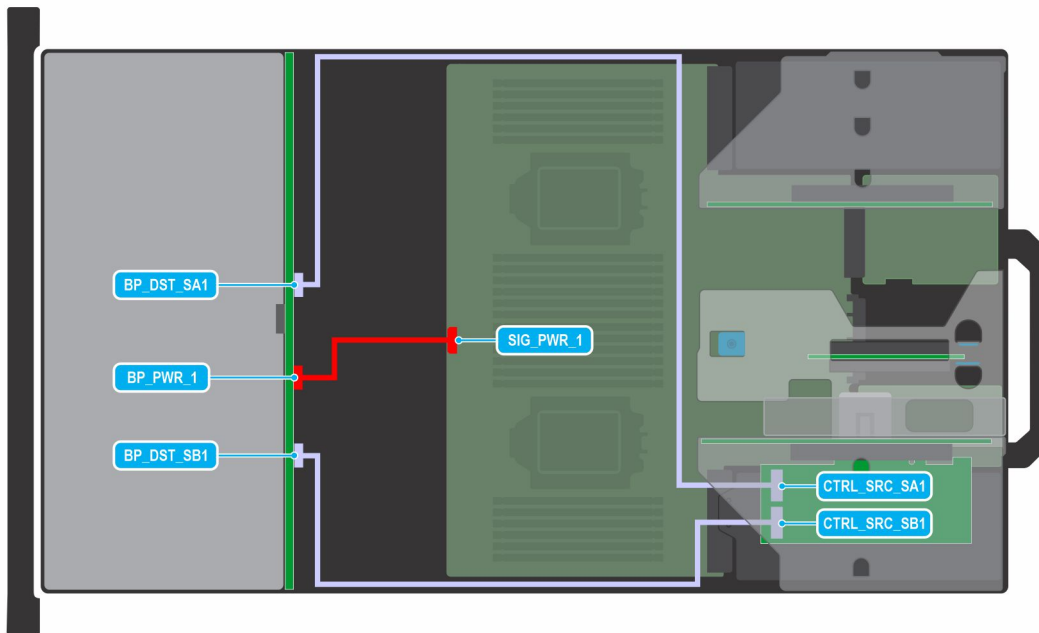

Figure 76. C2-1-R1: 12 x 3.5-inch SAS3/SATA RAID (w/ APERC11_R1)

NOTE: Follow the sequential order as shown in the table to remove the cables, to install the cables follow the reverse sequential order.

Table 74. 12 x 3.5-inch SAS3/SATA RAID (w/ APERC11_R1)

Order	From	To
1	SIG_PWR_1 (system board power connector)	BP_PWR_1 (backplane power connector)
2	CTRL_SRC_SA1 (adapter PERC controller connector)	BP_DST_SA1 (backplane signal connector)
3	CTRL_SRC_SB1 (adapter PERC controller connector)	BP_DST_SB1 (backplane signal connector)

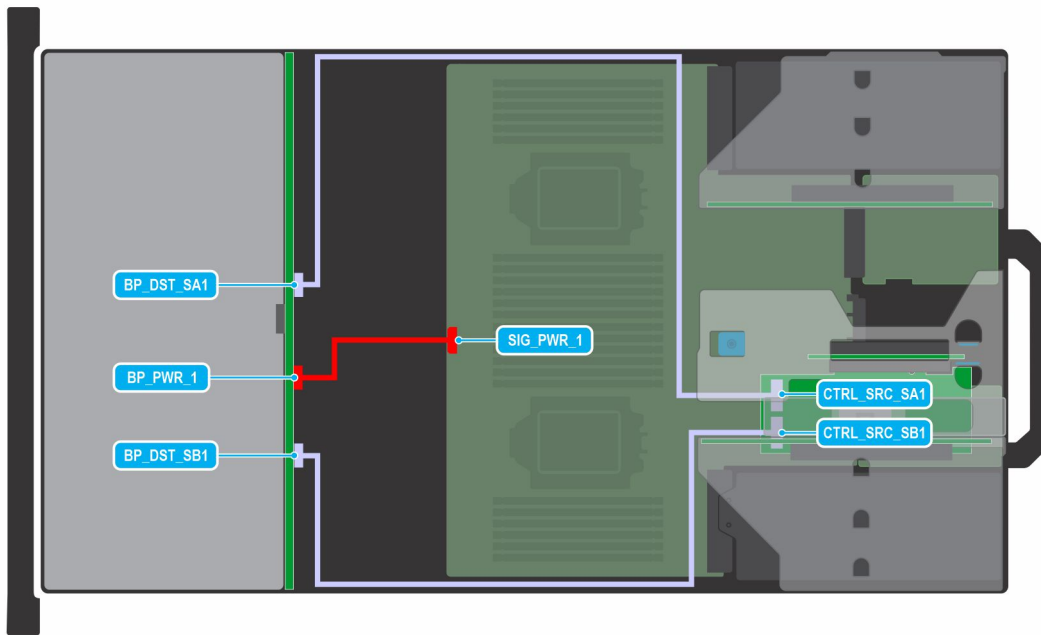

Figure 77. C2-1-R2: 12 x 3.5-inch SAS3/SATA RAID (w/ APERC11_R2)

NOTE: Follow the sequential order as shown in the table to remove the cables, to install the cables follow the reverse sequential order.

Table 75. 12 x 3.5-inch SAS3/SATA RAID (w/ APERC11_R2)

Order	From	To
1	SIG_PWR_1 (system board power connector)	BP_PWR_1 (backplane power connector)
2	CTRL_SRC_SA1 (adapter PERC controller connector)	BP_DST_SA1 (backplane signal connector)
3	CTRL_SRC_SB1 (adapter PERC controller connector)	BP_DST_SB1 (backplane signal connector)

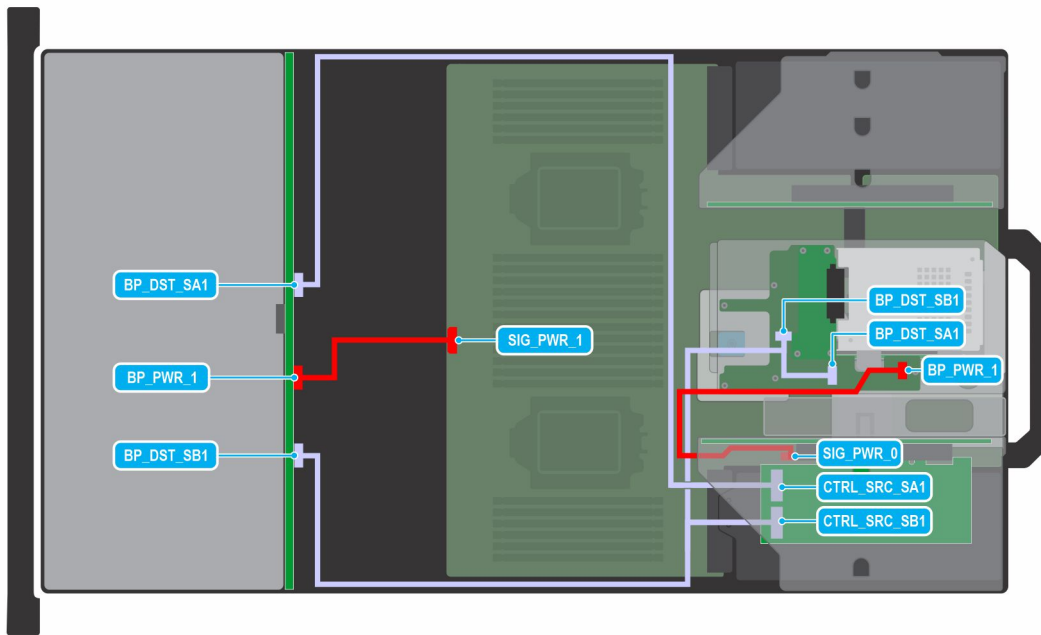

Figure 78. C2-2-R1: 12 x 3.5-inch SAS3/SATA RAID (w/ APERC11_R1) w/ Rear 2 x 2.5-inch

NOTE: Follow the sequential order as shown in the table to remove the cables, to install the cables follow the reverse sequential order.

Table 76. 12 x 3.5-inch SAS3/SATA RAID (w/ APERC11_R1) w/ Rear 2 x 2.5-inch

Order	From	To
1	SIG_PWR_1 (system board power connector)	BP_PWR_1 (backplane power connector)
2	CTRL_SRC_SB1 (adapter PERC controller connector) and BP_DST_SB1 (backplane signal connector)	BP_DST_SA1 (rear backplane signal connector) and BP_DST_SB1 (rear backplane signal connector)
3	CTRL_SRC_SA1 (adapter PERC controller connector)	BP_DST_SA1 (backplane signal connector)
4	SIG_PWR_0 (system board power connector)	BP_PWR_1 (rear backplane power connector)

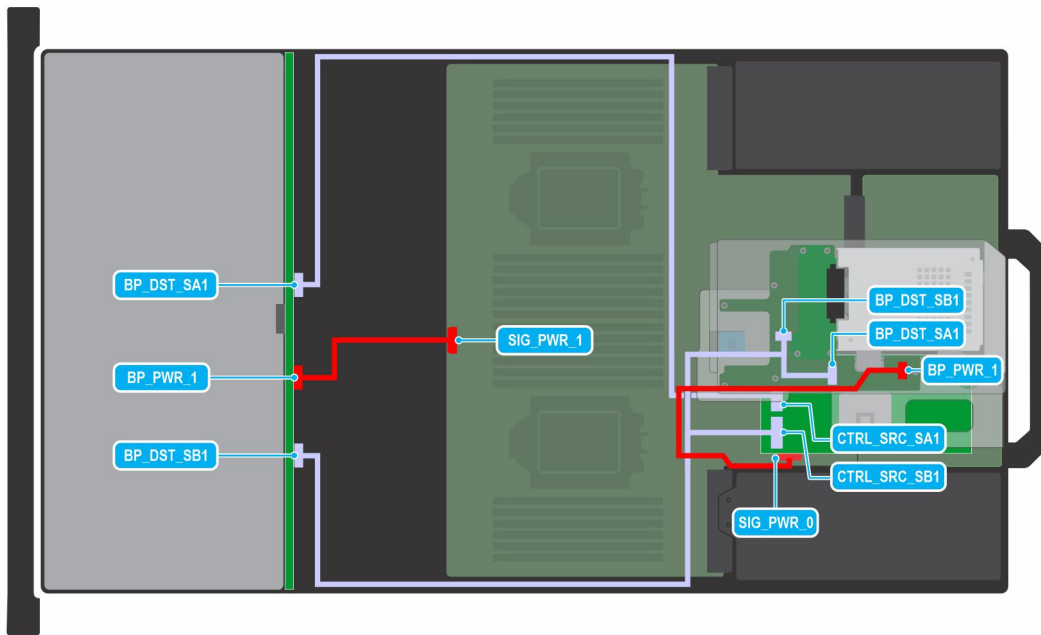

Figure 79. C2-2-R2: 12 x 3.5-inch SAS3/SATA RAID (w/ APERC11_R2) w/ Rear 2 x 2.5-inch

NOTE: Follow the sequential order as shown in the table to remove the cables, to install the cables follow the reverse sequential order.

Table 77. 12 x 3.5-inch SAS3/SATA RAID (w/ APERC11_R2) w/ Rear 2 x 2.5-inch

Order	From	To
1	SIG_PWR_1 (system board power connector)	BP_PWR_1 (backplane power connector)
2	CTRL_SRC_SB1 (adapter PERC controller connector) and BP_DST_SB1 (backplane signal connector)	BP_DST_SA1 (rear backplane signal connector) and BP_DST_SB1 (rear backplane signal connector)
3	CTRL_SRC_SA1 (adapter PERC controller connector)	BP_DST_SA1 (backplane signal connector)
4	SIG_PWR_0 (system board power connector)	BP_PWR_1 (rear backplane power connector)

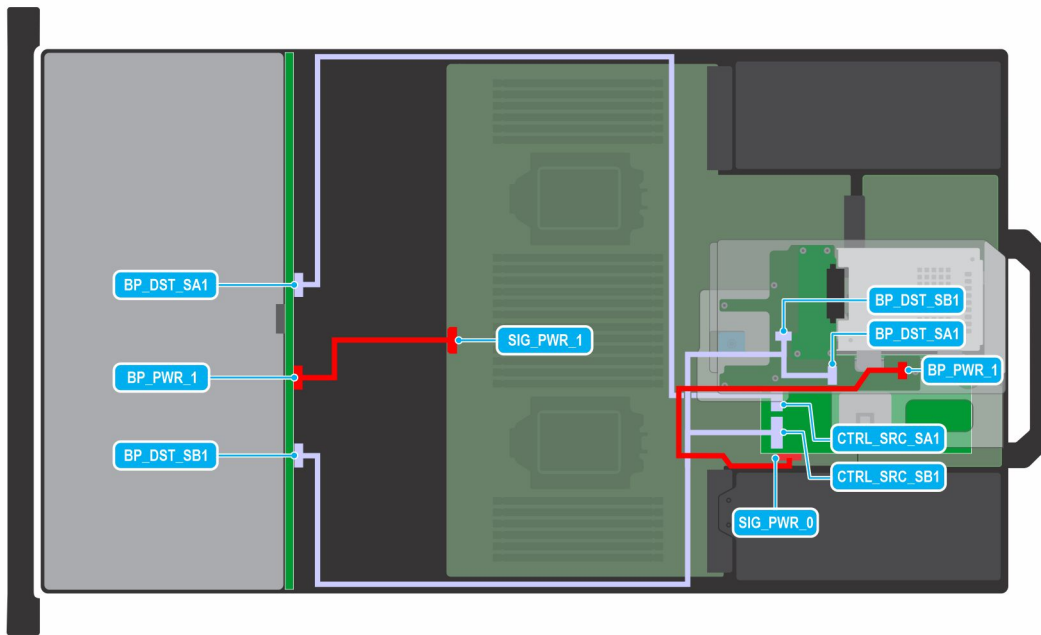

Figure 80. C2-3-R2: 12 x 3.5-inch SAS3/SATA RAID (w/ APERC12_R2) w/ Rear 2 x 2.5-inch

NOTE: Follow the sequential order as shown in the table to remove the cables, to install the cables follow the reverse sequential order.

Table 78. 12 x 3.5-inch SAS3/SATA RAID (w/ APERC12_R2) w/ Rear 2 x 2.5-inch

Order	From	To
1	SIG_PWR_1 (system board power connector)	BP_PWR_1 (backplane power connector)
2	CTRL_SRC_SB1 (adapter PERC controller connector) and BP_DST_SB1 (backplane signal connector)	BP_DST_SA1 (rear backplane signal connector) and BP_DST_SB1 (rear backplane signal connector)
3	CTRL_SRC_SA1 (adapter PERC controller connector)	BP_DST_SA1 (backplane signal connector)
4	SIG_PWR_0 (system board power connector)	BP_PWR_1 (rear backplane power connector)

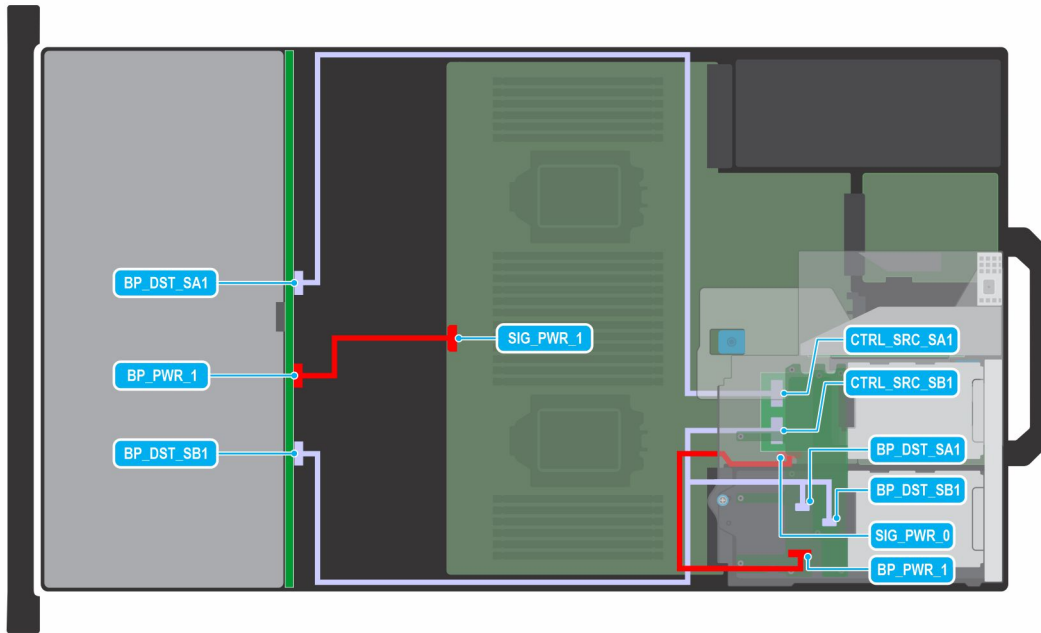

Figure 81. C2-4-R2: 12 x 3.5-inch SAS3/SATA RAID (w/ APERC11_R2) w/ Rear 4 x 2.5-inch

NOTE: Follow the sequential order as shown in the table to remove the cables, to install the cables follow the reverse sequential order.

Table 79. 12 x 3.5-inch SAS3/SATA RAID (w/ APERC11_R2) w/ Rear 4 x 2.5-inch

Order	From	To
1	SIG_PWR_1 (system board power connector)	BP_PWR_1 (backplane power connector)
2	CTRL_SRC_SB1 (adapter PERC controller connector) and BP_DST_SB1 (backplane signal connector)	BP_DST_SA1 (rear backplane signal connector) and BP_DST_SB1 (rear backplane signal connector)
3	CTRL_SRC_SA1 (adapter PERC controller connector)	BP_DST_SA1 (backplane signal connector)
4	SIG_PWR_0 (system board power connector)	BP_PWR_1 (rear backplane power connector)

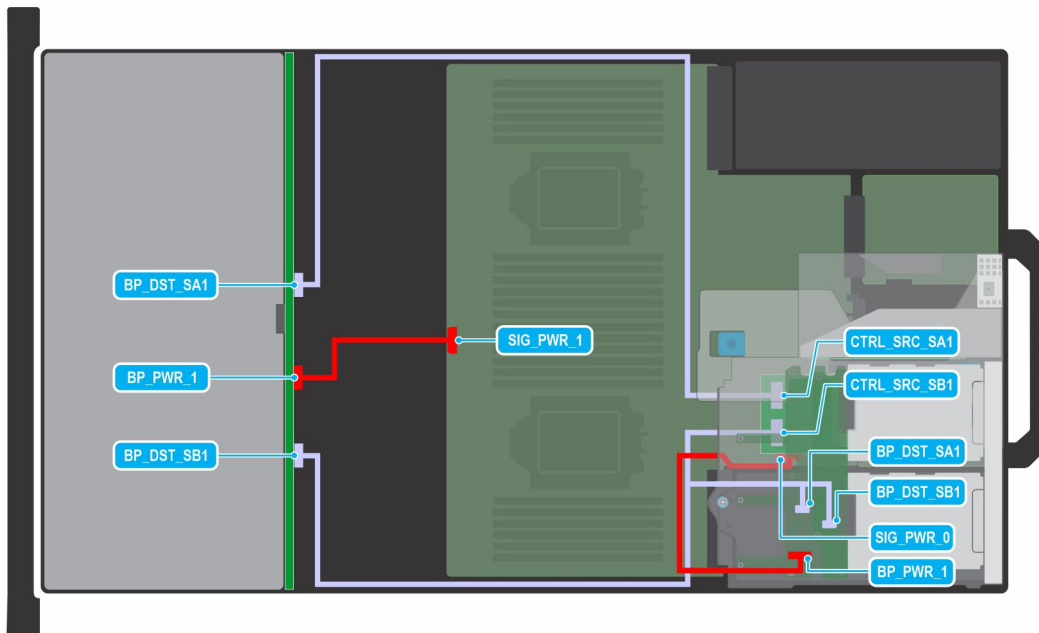

Figure 82. C2-5-R2: 12 x 3.5-inch SAS3/SATA RAID (w/ APERC12_R2) w/ Rear 4 x 2.5-inch

NOTE: Follow the sequential order as shown in the table to remove the cables, to install the cables follow the reverse sequential order.

Table 80. 12 x 3.5-inch SAS3/SATA RAID (w/ APERC12_R2) w/ Rear 4 x 2.5-inch

Order	From	To
1	SIG_PWR_1 (system board power connector)	BP_PWR_1 (backplane power connector)
2	CTRL_SRC_SB1 (adapter PERC controller connector) and BP_DST_SB1 (backplane signal connector)	BP_DST_SA1 (rear backplane signal connector) and BP_DST_SB1 (rear backplane signal connector)
3	CTRL_SRC_SA1 (adapter PERC controller connector)	BP_DST_SA1 (backplane signal connector)
4	SIG_PWR_0 (system board power connector)	BP_PWR_1 (rear backplane power connector)

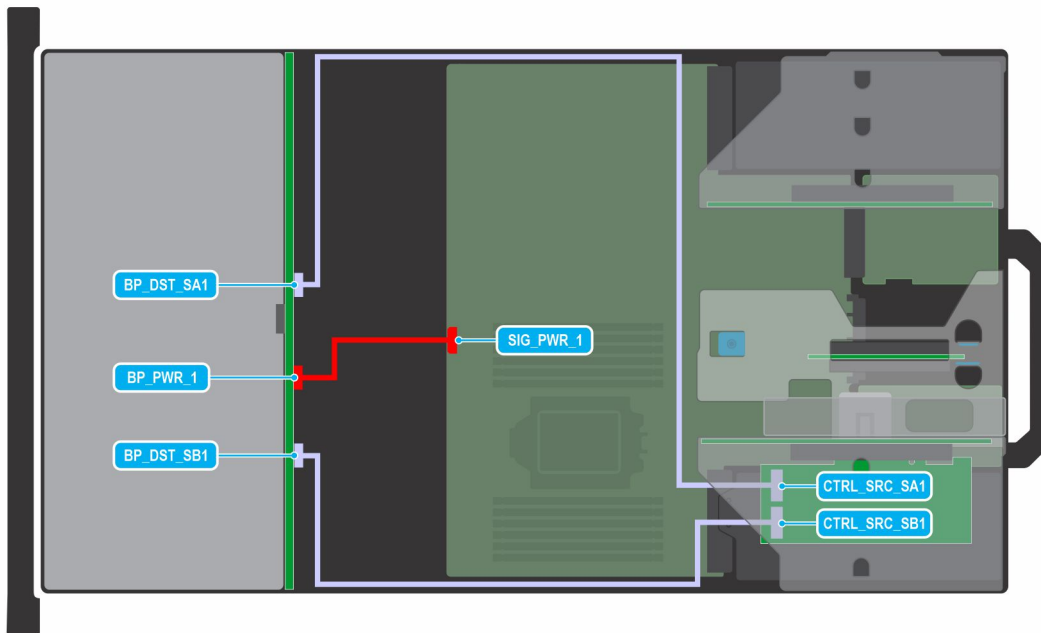

Figure 83. C2-7-R1: 12 x 3.5-inch SAS3/SATA RAID (w/ APERC11_R1) -1 CPU

NOTE: Follow the sequential order as shown in the table to remove the cables, to install the cables follow the reverse sequential order.

Table 81. 12 x 3.5-inch SAS3/SATA RAID (w/ APERC11_R1) -1 CPU

Order	From	To
1	SIG_PWR_1 (system board power connector)	BP_PWR_1 (backplane power connector)
2	CTRL_SRC_SA1 (adapter PERC controller connector)	BP_DST_SA1 (backplane signal connector)
3	CTRL_SRC_SB1 (adapter PERC controller connector)	BP_DST_SB1 (backplane signal connector)

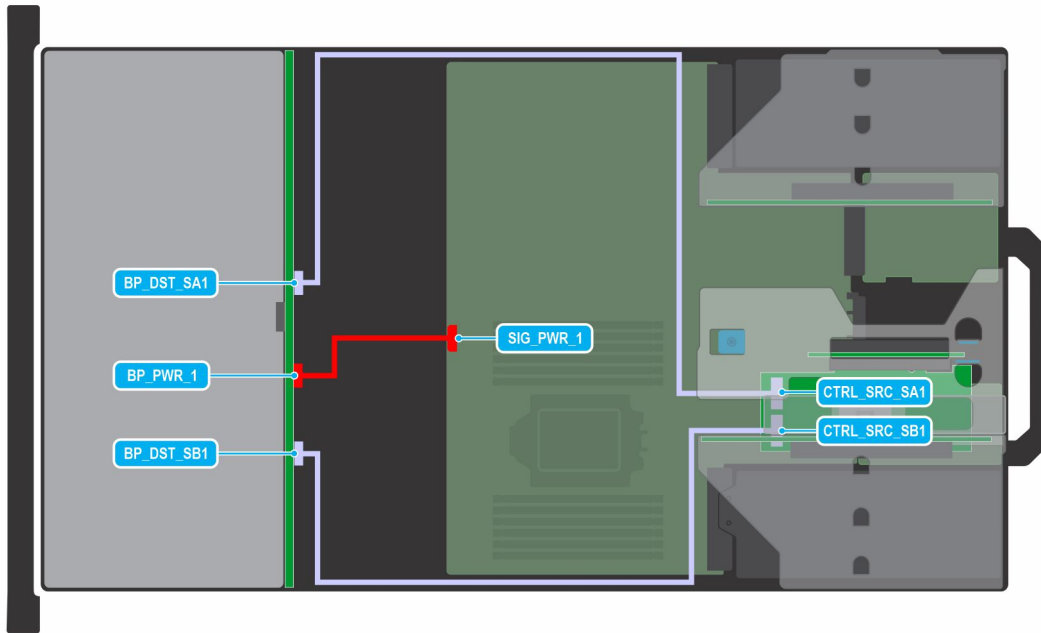

Figure 84. C2-7-R2: 12 x 3.5-inch SAS3/SATA RAID (w/ APERC11_R2) - 1 CPU

NOTE: Follow the sequential order as shown in the table to remove the cables, to install the cables follow the reverse sequential order.

Table 82. 12 x 3.5-inch SAS3/SATA RAID (w/ APERC11_R2) - 1 CPU

Order	From	To
1	SIG_PWR_1 (system board power connector)	BP_PWR_1 (backplane power connector)
2	CTRL_SRC_SA1 (adapter PERC controller connector)	BP_DST_SA1 (backplane signal connector)
3	CTRL_SRC_SB1 (adapter PERC controller connector)	BP_DST_SB1 (backplane signal connector)

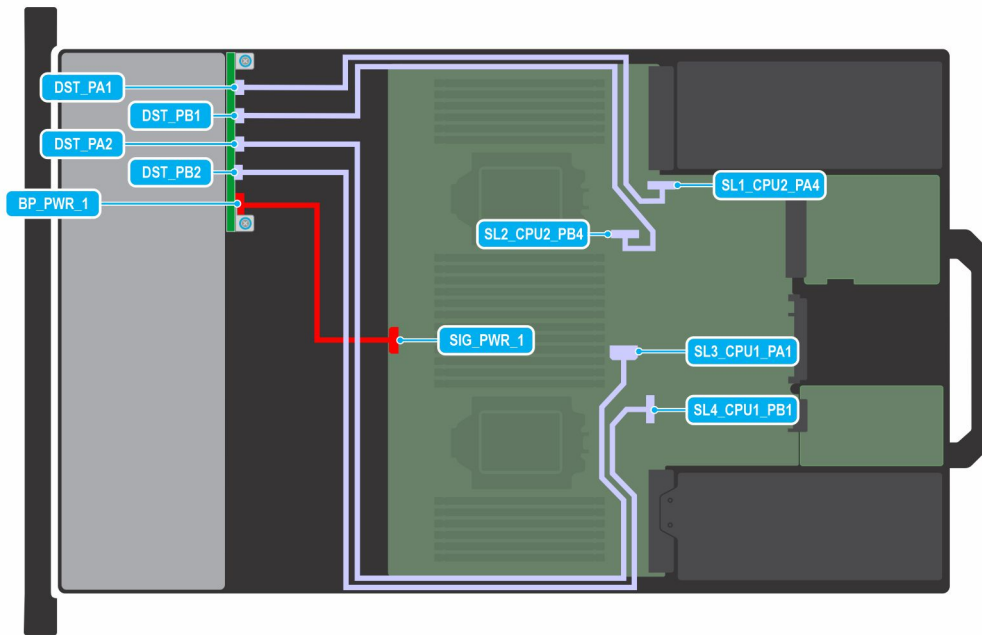

Figure 85. C3-1: 8 x U.2 G4

NOTE: Follow the sequential order as shown in the table to remove the cables, to install the cables follow the reverse sequential order.

Table 83. 8 x U.2 G4

Order	From	To
1	SL1_CPU2_PA4 (signal connector on system board)	DST_PA1 (backplane signal connector)
2	SL2_CPU2_PB4 (signal connector on system board)	DST_PB1 (backplane signal connector)
3	SL3_CPU1_PA1 (signal connector on system board) and SL4_CPU1_PB1 (signal connector on system board)	DST_PA2 (backplane signal connector) and DST_PB2 (backplane signal connector)
4	SIG_PWR_1 (system board power connector)	BP_PWR_1 (backplane power connector)

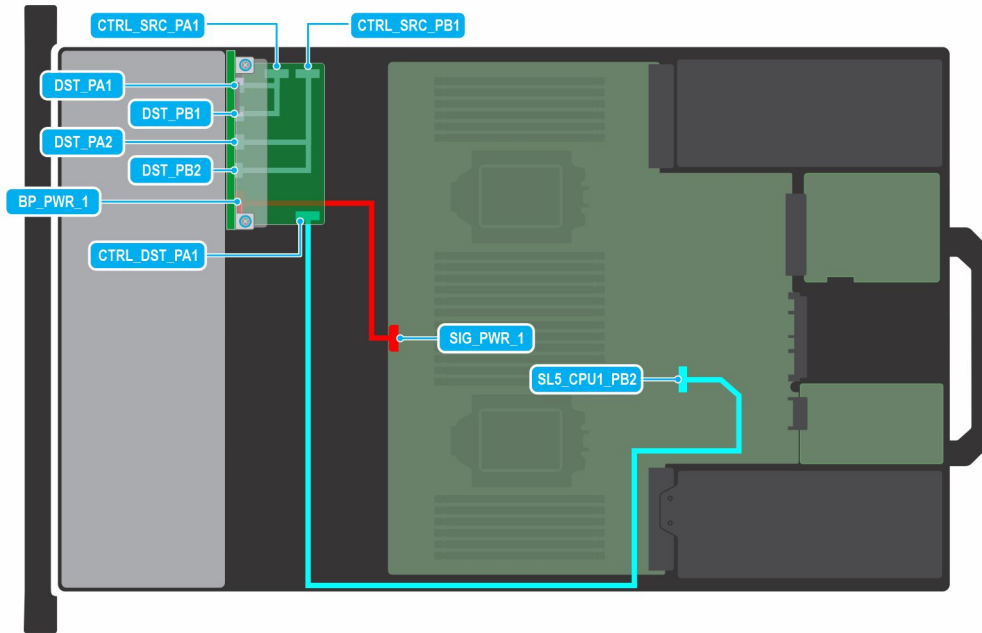

Figure 86. C3-2: 8 x U.2 G4 RAID (w/ FPERC11 N)

NOTE: Follow the sequential order as shown in the table to remove the cables, to install the cables follow the reverse sequential order.

Table 84. 8 x U.2 G4 RAID (w/ FPERC11 N)

Order	From	To
1	SL5_CPU1_PB2 (signal connector on system board)	CTRL_DST_PA1 (fPERC input connector)
2	SIG_PWR_1 (system board power connector)	BP_PWR_1 (backplane power connector)
3	CTRL_SRC_PB1 (fPERC controller connector)	DST_PA2 (backplane signal connector) and DST_PB2 (backplane signal connector)
4	CTRL_SRC_PA1 (fPERC controller connector)	DST_PA1 (backplane signal connector) and DST_PB1 (backplane signal connector)

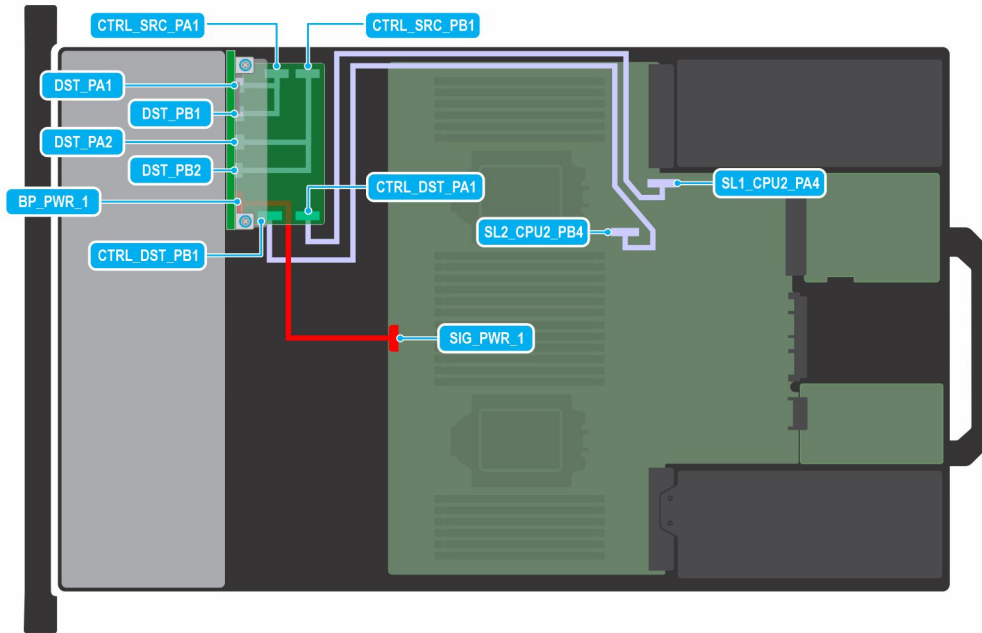

Figure 87. C3-3: 8 x U.2 G4 RAID (w/ FPERC12)

NOTE: Follow the sequential order as shown in the table to remove the cables, to install the cables follow the reverse sequential order.

Table 85. 8 x U.2 G4 RAID (w/ FPERC12)

Order	From	To
1	SL1_CPU2_PA4 (signal connector on system board)	CTRL_DST_PA1 (fPERC input connector)
2	SL2_CPU2_PB4 (signal connector on system board)	CTRL_DST_PB1 (fPERC input connector)
3	SIG_PWR_1 (system board power connector)	BP_PWR_1 (backplane power connector)
4	CTRL_SRC_PB1 (fPERC controller connector)	DST_PA2 (backplane signal connector) and DST_PB2 (backplane signal connector)
5	CTRL_SRC_PA1 (fPERC controller connector)	DST_PA1 (backplane signal connector) and DST_PB1 (backplane signal connector)

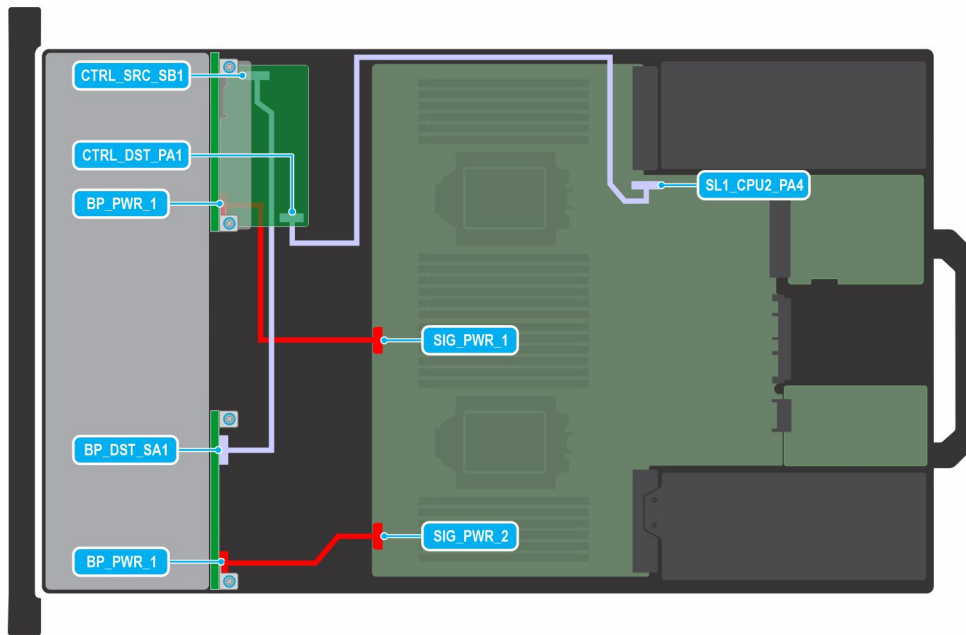

Figure 88. C4-1: 16 x 2.5-inch SAS4/SATA RAID-SmartFlow (w/ FPERC11)

NOTE: Follow the sequential order as shown in the table to remove the cables, to install the cables follow the reverse sequential order.

Table 86. 16 x 2.5-inch SAS4/SATA RAID-SmartFlow (w/ FPERC11)

Order	From	To
1	SL1_CPU2_PA4 (signal connector on system board)	CTRL_DST_PA1 (fPERC input connector)
2	SIG_PWR_1 (system board power connector)	BP_PWR_1 (backplane power connector)
3	CTRL_SRC_SB1 (fPERC controller connector)	BP_DST_SA1 (backplane signal connector)
4	SIG_PWR_2 (system board power connector)	BP_PWR_1 (backplane power connector)

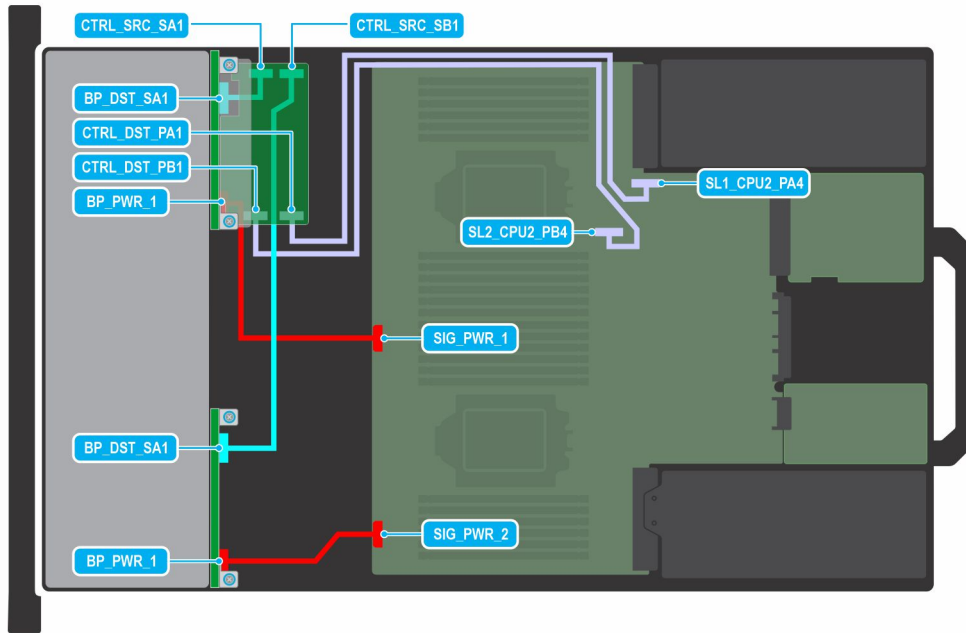

Figure 89. C4-2: 16 x 2.5-inch SAS4/SATA RAID-SmartFlow (w/ FPERC12)

Table 87. 16 x 2.5-inch SAS4/SATA RAID-SmartFlow (w/ FPERC12)

Order	From	To
1	SL1_CPU2_PA4 (signal connector on system board)	CTRL_DST_PA1 (fPERC input connector)
2	SL2_CPU2_PB4 (signal connector on system board)	CTRL_DST_PB1 (fPERC input connector)
3	SIG_PWR_1 (system board power connector)	BP_PWR_1 (backplane power connector)
4	CTRL_SRC_SA1 (fPERC controller connector)	BP_DST_SA1 (backplane signal connector)
5	CTRL_SRC_SB1 (fPERC controller connector)	BP_DST_SA1 (backplane signal connector)
6	SIG_PWR_2 (system board power connector)	BP_PWR_1 (backplane power connector)

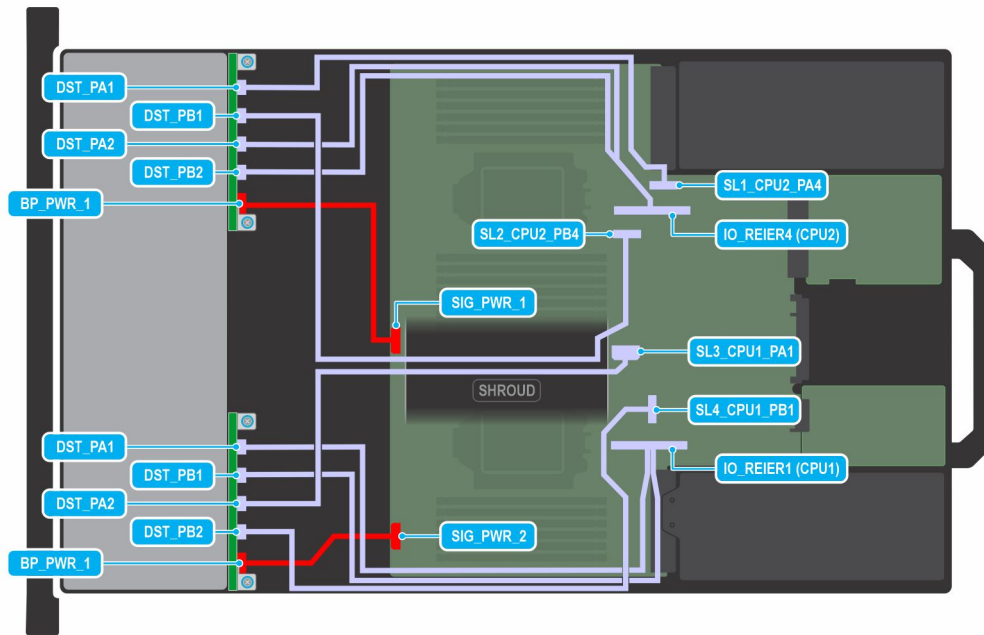

Figure 90. C5-1: 16 x U.2 G4 SmartFlow

NOTE: Follow the sequential order as shown in the table to remove the cables, to install the cables follow the reverse sequential order.

Table 88. 16 x U.2 G4 SmartFlow

Order	From	To
1	IO_RISER4(CPU2) (Riser 4 connector on system board)	DST_PA2 (backplane signal connector) and DST_PB2 (backplane signal connector)
2	SL1_CPU2_PA4 (signal connector on system board)	DST_PA1 (backplane signal connector)
3	SL2_CPU2_PB4 (signal connector on system board)	DST_PB1 (backplane signal connector)
4	SIG_PWR_1 (system board power connector)	BP_PWR_1 (backplane power connector)
5	SL3_CPU1_PA1 (signal connector on system board)	DST_PA2 (backplane signal connector)
6	SL4_CPU1_PB1 (signal connector on system board)	DST_PB2 (backplane signal connector)
7	SIG_PWR_2 (system board power connector)	BP_PWR_1 (backplane power connector)
8	IO_RISER1(CPU1) (Riser 1 connector on system board)	DST_PA6 (backplane signal connector) and DST_PB6 (backplane signal connector)

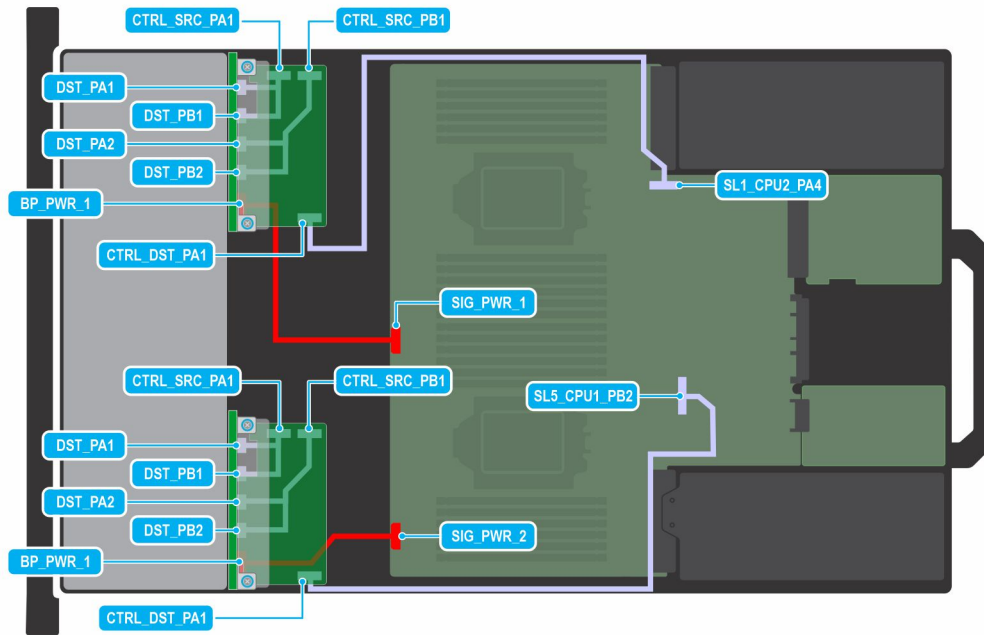

Figure 91. C5-2: 16 x U.2 G4 RAID SmartFlow (Two PERCs) (w/ FPERC11 N)

NOTE: Follow the sequential order as shown in the table to remove the cables, to install the cables follow the reverse sequential order.

Table 89. 16 x U.2 G4 RAID SmartFlow (Two PERCs) (w/ FPERC11 N)

Order	From	To
1	SIG_PWR_1 (system board power connector)	BP_PWR_1 (backplane power connector)
2	SL1_CPU2_PA4 (signal connector on system board)	CTRL_DST_PA1 (fPERC input connector)
3	SL5_CPU1_PB2 (signal connector on system board)	CTRL_DST_PA1 (fPERC input connector)
4	SIG_PWR_2 (system board power connector)	BP_PWR_1 (backplane power connector)
5	CTRL_SRC_PB1 (fPERC controller connector)	DST_PA2 (backplane signal connector) and DST_PB2 (backplane signal connector)
6	CTRL_SRC_PA1 (fPERC controller connector)	DST_PA1 (backplane signal connector) and DST_PB1 (backplane signal connector)

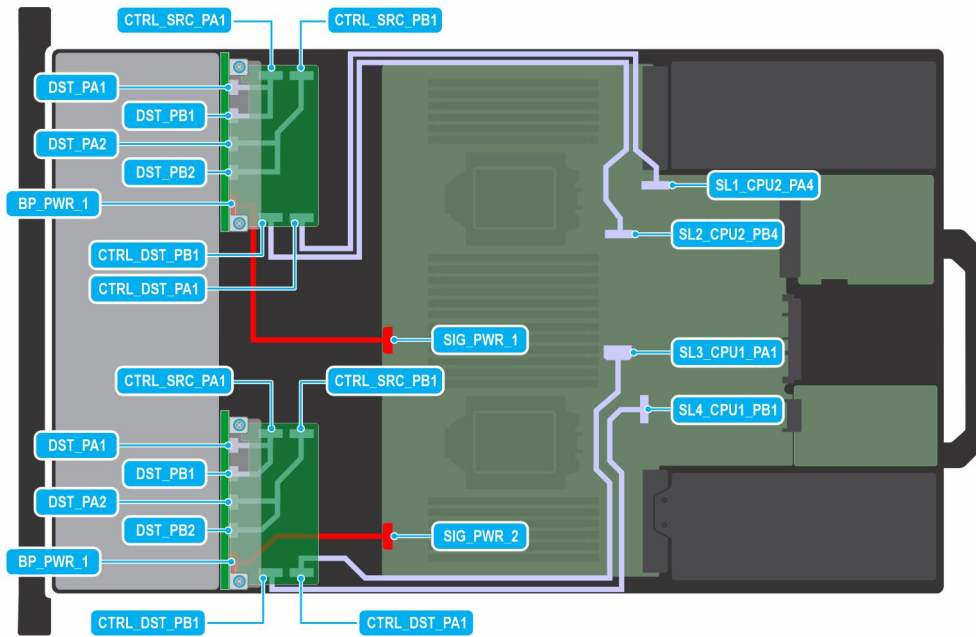

Figure 92. C5-3: 16 x U.2 G4 RAID SmartFlow (Two PERCs) (w/ FPERC12)

NOTE: Follow the sequential order as shown in the table to remove the cables, to install the cables follow the reverse sequential order.

Table 90. 16 x U.2 G4 RAID SmartFlow (Two PERCs) (w/ FPERC12)

Order	From	To
1	SIG_PWR_1 (system board power connector)	BP_PWR_1 (backplane power connector)
2	SL1_CPU2_PA4 (signal connector on system board)	CTRL_DST_PA1 (fPERC input connector)
3	SL2_CPU2_PB4 (signal connector on system board)	CTRL_DST_PB1 (fPERC input connector)
4	SIG_PWR_2 (system board power connector)	BP_PWR_2 (backplane power connector)
5	CTRL_SRC_PB1 (fPERC controller connector)	DST_PA2 (backplane signal connector) and DST_PB2 (backplane signal connector)
6	CTRL_SRC_PA1 (fPERC controller connector)	DST_PA1 (backplane signal connector) and DST_PB1 (backplane signal connector)
7	SL3_CPU1_PA1 (signal connector on system board)	CTRL_DST_PA1 (fPERC input connector)
8	SL4_CPU1_PB1 (signal connector on system board)	CTRL_DST_PB1 (fPERC input connector)

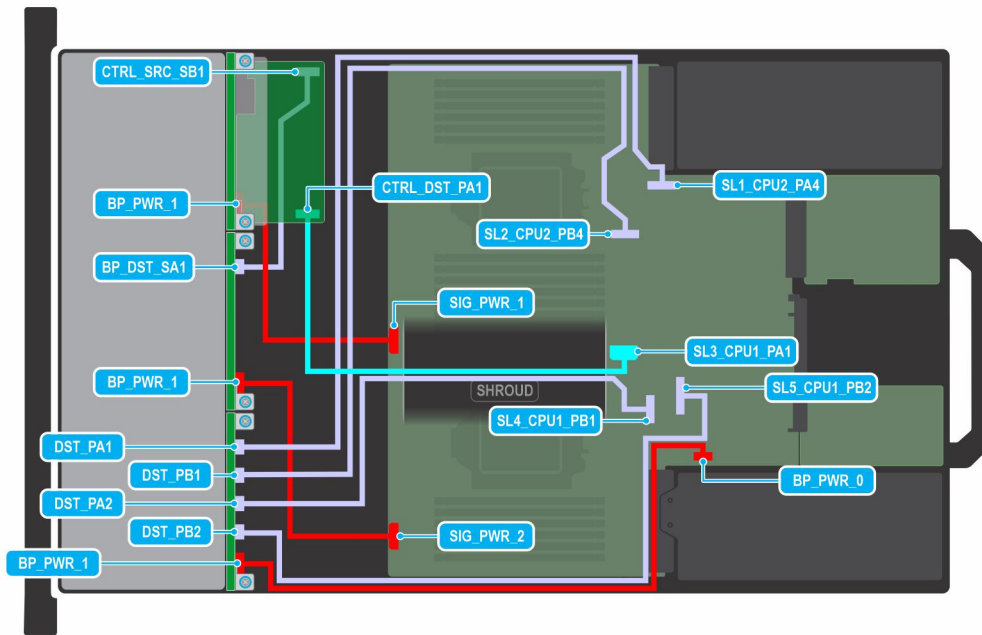

Figure 93. C6-1: 16 x 2.5-inch SAS4/SATA RAID + 8 x U.2 G4 (w/ FPERC11)

NOTE: Follow the sequential order as shown in the table to remove the cables, to install the cables follow the reverse sequential order.

Table 91. 16 x 2.5-inch SAS4/SATA RAID + 8 x U.2 G4 (w/ FPERC11)

Order	From	To
1	SL1_CPU2_PA4 (signal connector on system board)	DST_PA1 (backplane signal connector)
2	SL2_CPU2_PB4 (signal connector on system board)	DST_PB1 (backplane signal connector)
3	SL3_CPU1_PA1 (signal connector on system board)	CTRL_DST_PA1 (fPERC input connector)
4	SIG_PWR_1 (system board power connector)	BP_PWR_1 (backplane power connector)
5	CTRL_SRC_SB1 (fPERC controller connector)	BP_DST_SA1 (backplane expander signal connector)
6	SIG_PWR_2 (system board power connector)	BP_PWR_1 (backplane power connector)
7	SL4_CPU1_PB1 (signal connector on system board)	DST_PA2 (backplane signal connector)
8	SL5_CPU1_PB2 (signal connector on system board)	DST_PB2 (backplane signal connector)
9	BP_PWR_0 (rear backplane power connector)	BP_PWR_1 (backplane power connector)

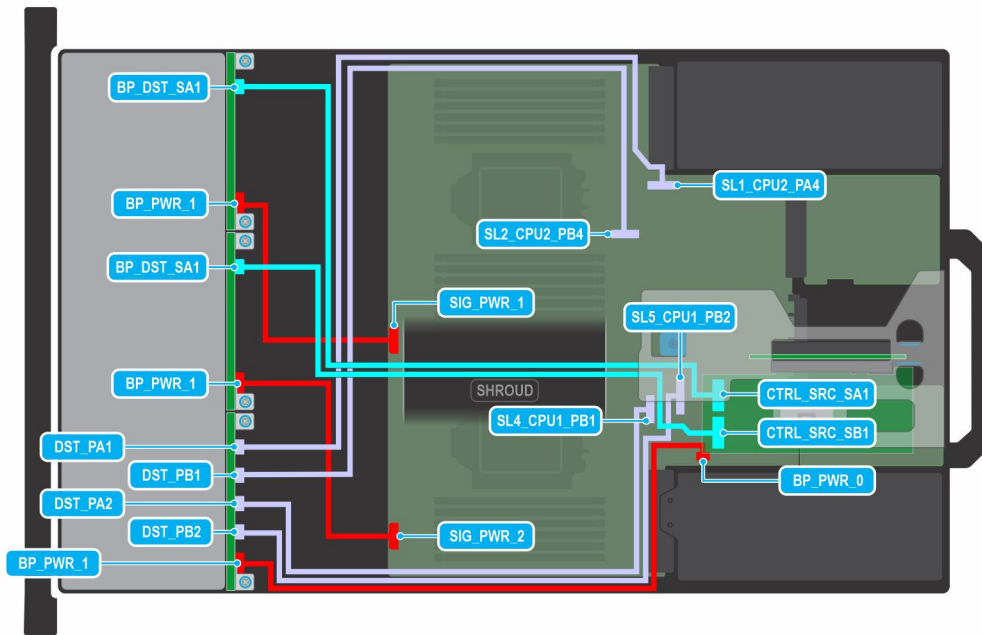

Figure 94. C6-2: 16 x 2.5-inch SAS4/SATA RAID + 8 x U.2 G4 (w/ APERC12)

NOTE: Follow the sequential order as shown in the table to remove the cables, to install the cables follow the reverse sequential order.

Table 92. 16 x 2.5-inch SAS4/SATA RAID + 8 x U.2 G4 (w/ APERC12)

Order	From	To
1	SL1_CPU2_PA4 (signal connector on system board)	DST_PA1 (backplane signal connector)
2	SL2_CPU2_PB4 (signal connector on system board)	DST_PB1 (backplane signal connector)
3	SIG_PWR_1 (system board power connector)	BP_PWR_1 (backplane power connector)
4	CTRL_SRC_SA1 (fPERC controller connector)	BP_DST_SA1 (backplane signal connector)
5	CTRL_SRC_SB1 (fPERC controller connector)	BP_DST_SA1 (backplane signal connector)
6	SIG_PWR_2 (system board power connector)	BP_PWR_1 (backplane power connector)
7	SL4_CPU1_PB1 (signal connector on system board)	DST_PA2 (backplane signal connector)
8	SL5_CPU1_PB2 (signal connector on system board)	DST_PB2 (backplane signal connector)
9	BP_PWR_0 (rear backplane power connector)	BP_PWR_1 (backplane power connector)

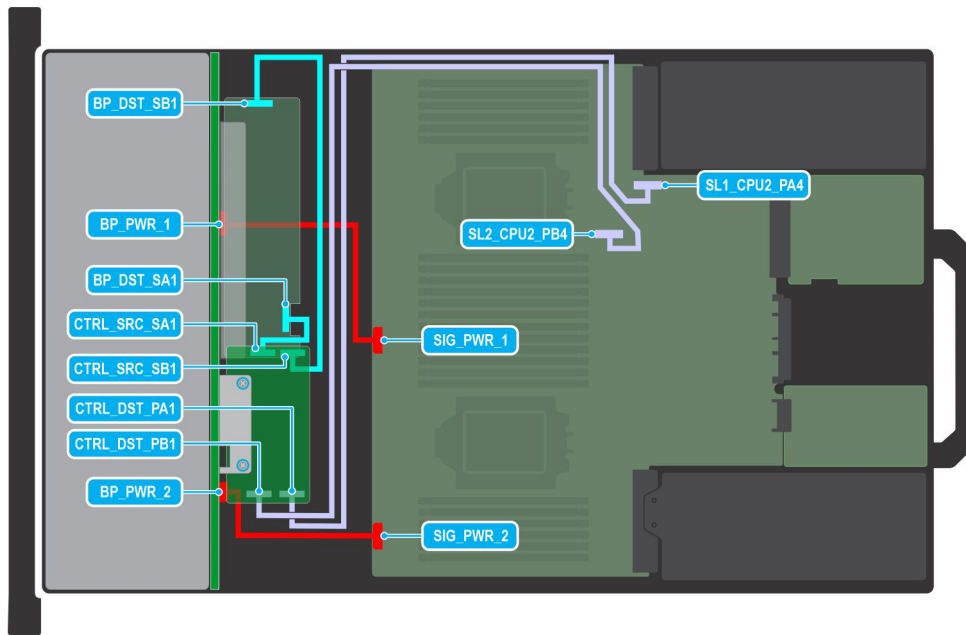

Figure 95. C7-2: 24 x 2.5-inch SAS4/SATA (w/ FPERC12)

NOTE: Follow the sequential order as shown in the table to remove the cables, to install the cables follow the reverse sequential order.

Table 93. 24 x 2.5-inch SAS4/SATA (w/ FPERC12)

Order	From	To
1	SL1_CPU2_PA4 (signal connector on system board)	CTRL_DST_PA1 (fPERC input connector)
2	SL2_CPU2_PB4 (signal connector on system board)	CTRL_DST_PB1 (fPERC input connector)
3	SIG_PWR_1 (system board power connector)	BP_PWR_1 (backplane power connector)
4	CTRL_SRC_SB1 (fPERC controller connector)	BP_DST_SB1 (backplane expander signal connector)
5	CTRL_SRC_SA1 (fPERC controller connector)	BP_DST_SA1 (backplane expander signal connector)
6	SIG_PWR_2 (system board power connector)	BP_PWR_2 (backplane power connector)

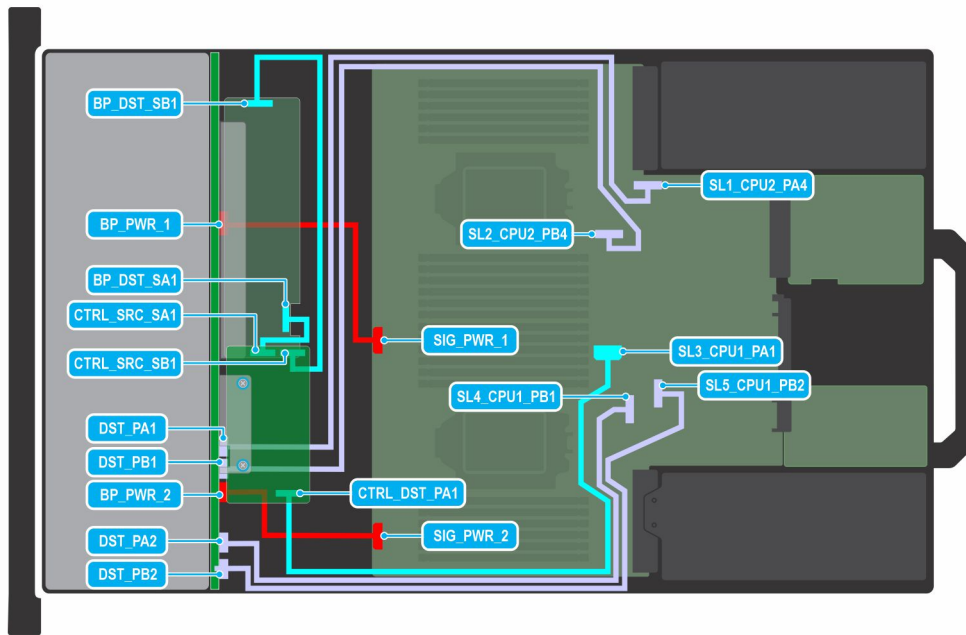

Figure 96. C7-3: 24 x 2.5-inch SAS4/SATA w/ 8 x Uni (w/ FPERC11)

NOTE: Follow the sequential order as shown in the table to remove the cables, to install the cables follow the reverse sequential order.

Table 94. 24 x 2.5-inch SAS4/SATA w/ 8 x Uni (w/ FPERC11)

Order	From	To
1	SL1_CPU2_PA4 (signal connector on system board)	DST_PA1 (backplane signal connector)
2	SL2_CPU2_PB4 (signal connector on system board)	DST_PB1 (backplane signal connector)
3	SIG_PWR_1 (system board power connector)	BP_PWR_1 (backplane power connector)
4	SL3_CPU1_PA1 (signal connector on system board)	CTRL_DST_PA1 (fPERC input connector)
5	CTRL_SRC_SB1 (fPERC controller connector)	BP_DST_SB1 (backplane expander signal connector)
6	CTRL_SRC_SA1 (fPERC controller connector)	BP_DST_SA1 (backplane expander signal connector)
7	SL4_CPU1_PB1 (signal connector on system board)	DST_PA2 (backplane signal connector)
8	SL5_CPU1_PB2 (signal connector on system board)	DST_PB2 (backplane signal connector)
9	SIG_PWR_2 (system board power connector)	BP_PWR_2 (backplane power connector)

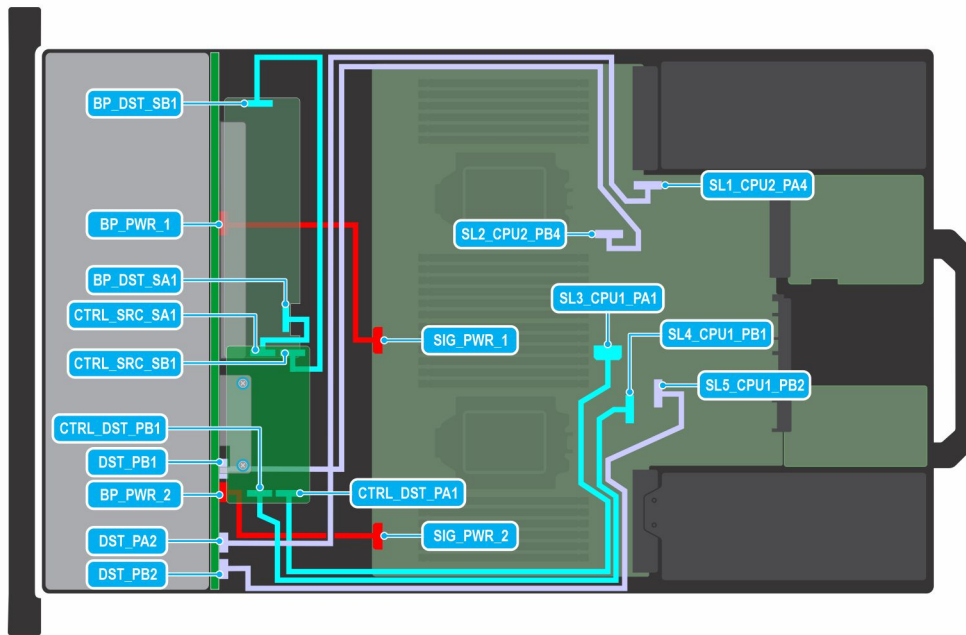

Figure 97. C7-4: 24 x 2.5-inch SAS4/SATA w/ 6 x Uni (w/ FPERC12)

NOTE: Follow the sequential order as shown in the table to remove the cables, to install the cables follow the reverse sequential order.

Table 95. 24 x 2.5-inch SAS4/SATA w/ 6 x Uni (w/ FPERC12)

Order	From	To
1	SL1_CPU2_PA4 (signal connector on system board)	DST_PA2 (backplane signal connector)
2	SL2_CPU2_PB4 (signal connector on system board)	DST_PB1 (backplane signal connector)
3	SIG_PWR_1 (system board power connector)	BP_PWR_1 (backplane power connector)
4	CTRL_SRC_SA1 (fPERC controller connector)	BP_DST_SA1 (backplane signal connector)
5	CTRL_SRC_SB1 (fPERC controller connector)	BP_DST_SB1 (backplane signal connector)
6	SL3_CPU1_PA1 (signal connector on system board)	CTRL_DST_PA1 (fPERC input connector)
7	SL4_CPU1_PB1 (signal connector on system board)	CTRL_DST_PB1 (fPERC input connector)
8	SIG_PWR_2 (system board power connector)	BP_PWR_2 (backplane power connector)
9	SL5_CPU1_PB2 (signal connector on system board)	DST_PB2 (backplane signal connector)

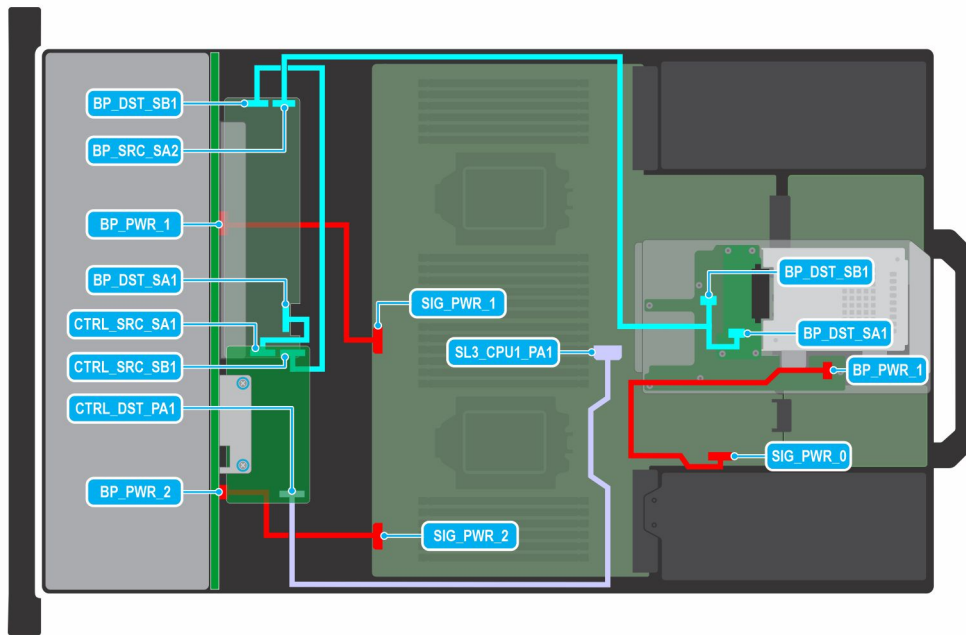

Figure 98. C7-5: 24 x 2.5-inch SAS4/SATA (w/ FPERC11) w/ 2 x 2.5-inch

NOTE: Follow the sequential order as shown in the table to remove the cables, to install the cables follow the reverse sequential order.

Table 96. 24 x 2.5-inch SAS4/SATA (w/ FPERC11) w/ 2 x 2.5-inch

Order	From	To
1	SIG_PWR_1 (system board power connector)	BP_PWR_1 (backplane power connector)
2	SL3_CPU1_PA1 (signal connector on system board)	CTRL_DST_PA1 (fPERC input connector)
3	CTRL_SRC_SB1 (fPERC controller connector)	BP_DST_SB1 (backplane expander signal connector)
4	CTRL_SRC_SA1 (fPERC controller connector)	BP_DST_SA1 (backplane expander signal connector)
5	SIG_PWR_2 (system board power connector)	BP_PWR_2 (backplane power connector)
6	BP_SRC_SA2 (backplane expander signal connector)	BP_DST_SA1 (rear backplane signal connector) and BP_DST_SB1 (rear backplane signal connector)
7	SIG_PWR_0 (system board power connector)	BP_PWR_1 (rear backplane power connector)

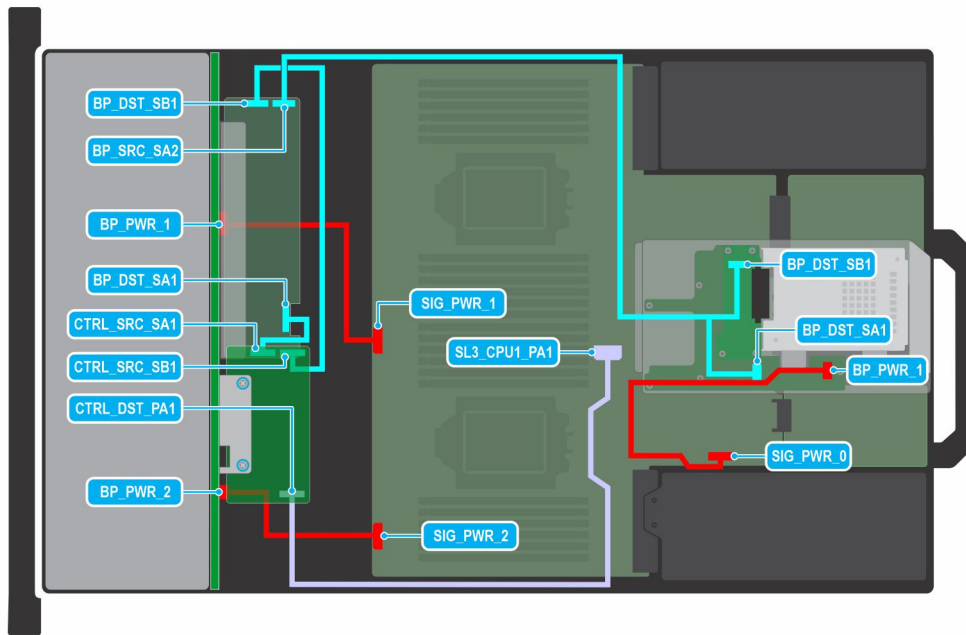

Figure 99. C7-6: 24 x 2.5-inch SAS4/SATA (w/ FPERC12) w/ 2 x 2.5-inch

NOTE: Follow the sequential order as shown in the table to remove the cables, to install the cables follow the reverse sequential order.

Table 97. 24 x 2.5-inch SAS4/SATA (w/ FPERC12) w/ 2 x 2.5-inch

Order	From	To
1	SIG_PWR_1 (system board power connector)	BP_PWR_1 (backplane power connector)
2	SL3_CPU1_PA1 (signal connector on system board)	CTRL_DST_PA1 (fPERC input connector)
3	SL4_CPU1_PB1 (signal connector on system board)	CTRL_DST_PB1 (fPERC input connector)
4	CTRL_SRC_SB1 (fPERC controller connector)	BP_DST_SB1 (backplane expander signal connector)
5	CTRL_SRC_SA1 (fPERC controller connector)	BP_DST_SA1 (backplane expander signal connector)
6	SIG_PWR_2 (system board power connector)	BP_PWR_2 (backplane power connector)
7	BP_SRC_SA2 (backplane expander signal connector)	BP_DST_SA1 (rear backplane signal connector) and BP_DST_SB1 (rear backplane signal connector)
8	SIG_PWR_0 (system board power connector)	BP_PWR_1 (rear backplane power connector)

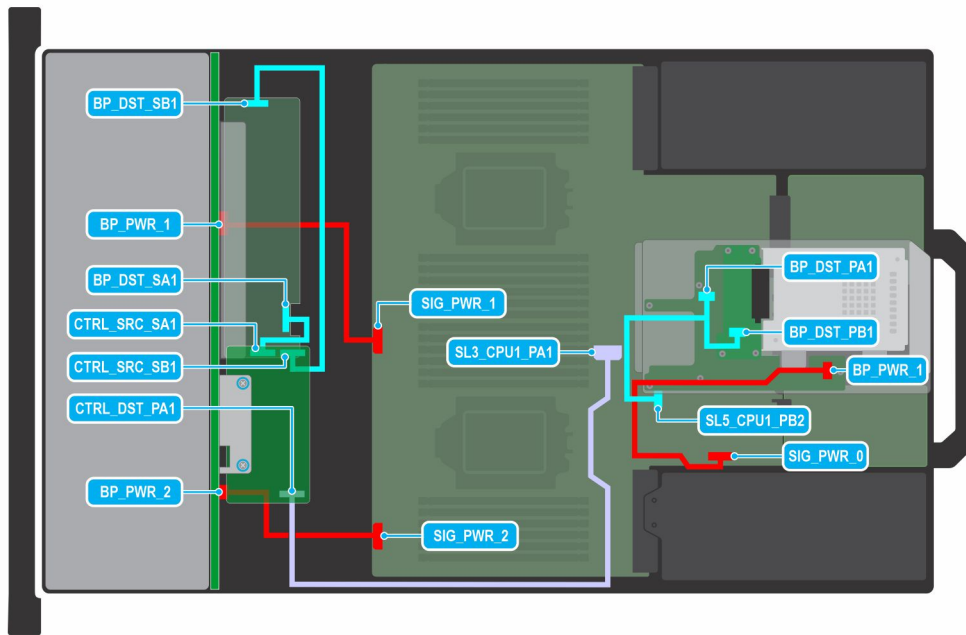

Figure 100. C7-7: 24 x 2.5-inch SAS4/SATA (w/ FPERC11) w/ 2 x U.2

NOTE: Follow the sequential order as shown in the table to remove the cables, to install the cables follow the reverse sequential order.

Table 98. 24 x 2.5-inch SAS4/SATA (w/ FPERC11) w/ 2 x U.2

Order	From	To
1	SIG_PWR_1 (system board power connector)	BP_PWR_1 (backplane power connector)
2	SL3_CPU1_PA1 (signal connector on system board)	CTRL_DST_PA1 (fPERC input connector)
3	CTRL_SRC_SB1 (fPERC controller connector)	BP_DST_SB1 (backplane expander signal connector)
4	CTRL_SRC_SA1 (fPERC controller connector)	BP_DST_SA1 (backplane expander signal connector)
5	SIG_PWR_2 (system board power connector)	BP_PWR_2 (backplane power connector)
6	SIG_PWR_0 (system board power connector)	BP_PWR_1 (rear backplane power connector)
7	SL5_CPU1_PB2 (signal connector on system board)	BP_DST_PA1 (rear backplane signal connector) and BP_DST_PB1 (rear backplane signal connector)

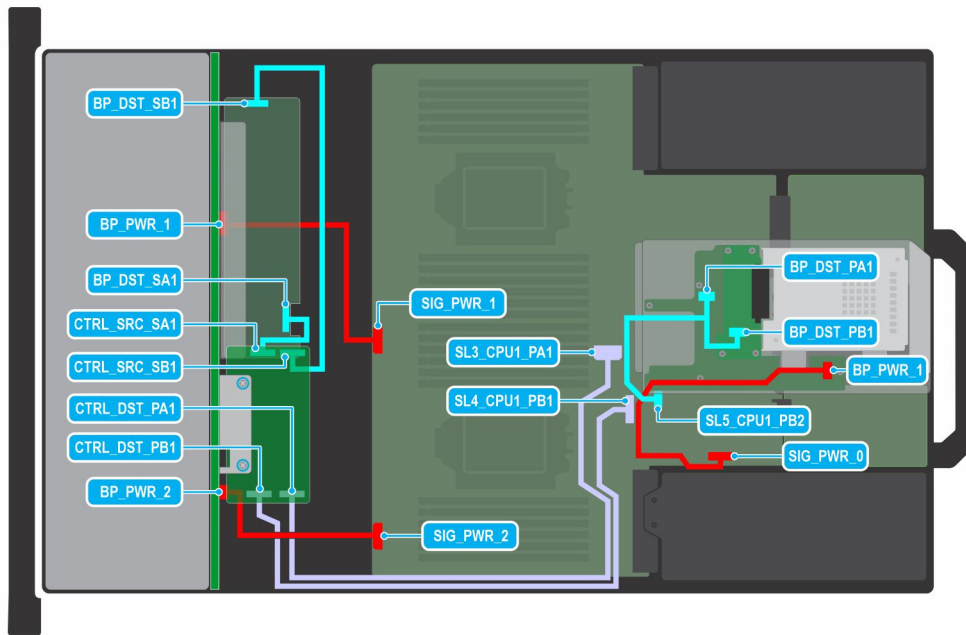

Figure 101. C7-8: 24 x 2.5-inch SAS4/SATA (w/ FPERC12) w/ 2 x U.2

NOTE: Follow the sequential order as shown in the table to remove the cables, to install the cables follow the reverse sequential order.

Table 99. 24 x 2.5-inch SAS4/SATA (w/ FPERC11) w/ 2 x U.2

Order	From	To
1	SIG_PWR_1 (system board power connector)	BP_PWR_1 (backplane power connector)
2	SL3_CPU1_PA1 (signal connector on system board)	CTRL_DST_PA1 (fPERC input connector)
3	SL4_CPU1_PB1 (signal connector on system board)	CTRL_DST_PB1 (fPERC input connector)
4	CTRL_SRC_SB1 (fPERC controller connector)	BP_DST_SB1 (backplane expander signal connector)
5	CTRL_SRC_SA1 (fPERC controller connector)	BP_DST_SA1 (backplane expander signal connector)
6	SIG_PWR_2 (system board power connector)	BP_PWR_2 (backplane power connector)
7	SIG_PWR_0 (system board power connector)	BP_PWR_1 (rear backplane power connector)
8	SL5_CPU1_PB2 (signal connector on system board)	BP_DST_PA1 (rear backplane signal connector) and BP_DST_PB1 (rear backplane signal connector)

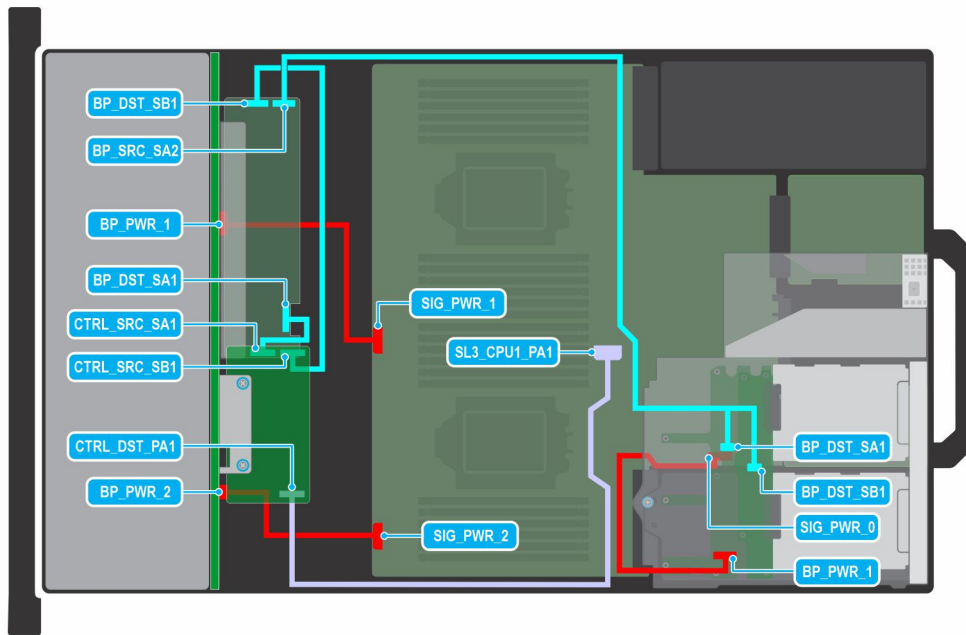

Figure 102. C7-9: 24 x 2.5-inch SAS4/SATA (w/ FPERC11) w/ 4 x 2.5-inch

NOTE: Follow the sequential order as shown in the table to remove the cables, to install the cables follow the reverse sequential order.

Table 100. 24 x 2.5-inch SAS4/SATA (w/ FPERC11) w/ 4 x 2.5-inch

Order	From	To
1	SIG_PWR_1 (system board power connector)	BP_PWR_1 (backplane power connector)
2	SL3_CPU1_PA1 (signal connector on system board)	CTRL_DST_PA1 (fPERC input connector)
3	CTRL_SRC_SB1 (fPERC controller connector)	BP_DST_SB1 (backplane expander signal connector)
4	CTRL_SRC_SA1 (fPERC controller connector)	BP_DST_SA1 (backplane expander signal connector)
5	SIG_PWR_2 (system board power connector)	BP_PWR_2 (backplane power connector)
6	SIG_PWR_0 (system board power connector)	BP_PWR_1 (rear backplane power connector)
7	BP_SRC_SA2 (backplane expander signal connector)	BP_DST_SA1 (rear backplane signal connector) and BP_DST_SB1 (rear backplane signal connector)

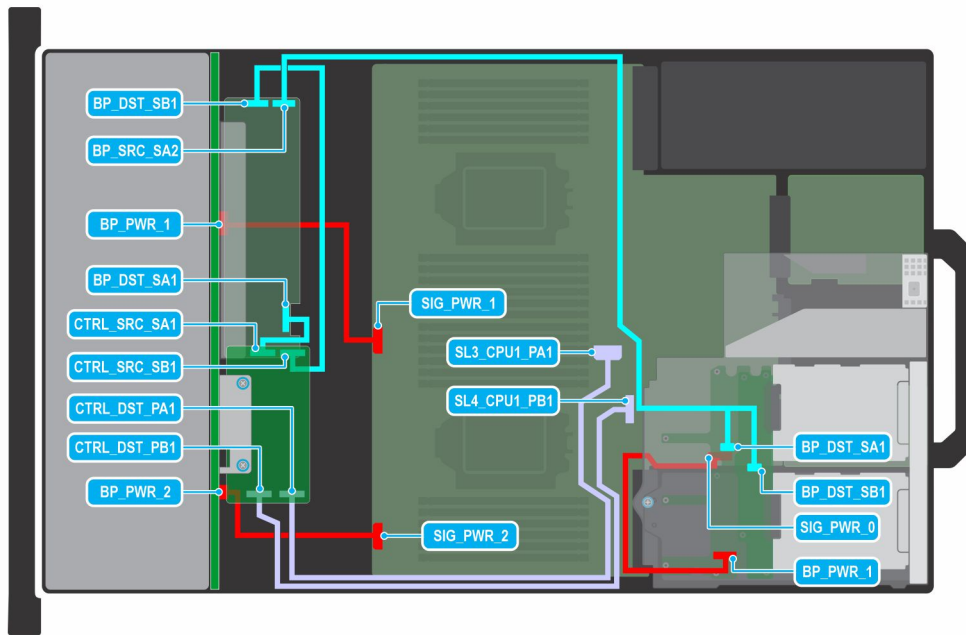

Figure 103. C7-10: 24 x 2.5-inch SAS4/SATA (w/ FPERC12) w/ 4 x 2.5-inch

NOTE: Follow the sequential order as shown in the table to remove the cables, to install the cables follow the reverse sequential order.

Table 101. 24 x 2.5-inch SAS4/SATA (w/ FPERC12) w/ 4 x 2.5-inch

Order	From	To
1	SIG_PWR_1 (system board power connector)	BP_PWR_1 (backplane power connector)
2	SL3_CPU1_PA1 (signal connector on system board)	CTRL_DST_PA1 (fPERC input connector)
3	SL4_CPU1_PB1 (signal connector on system board)	CTRL_DST_PB1 (fPERC input connector)
4	CTRL_SRC_SB1 (fPERC controller connector)	BP_DST_SB1 (backplane expander signal connector)
5	CTRL_SRC_SA1 (fPERC controller connector)	BP_DST_SA1 (backplane expander signal connector)
6	SIG_PWR_2 (system board power connector)	BP_PWR_2 (backplane power connector)
7	SIG_PWR_0 (system board power connector)	BP_PWR_1 (rear backplane power connector)
8	BP_SRC_SA2 (backplane expander signal connector)	BP_DST_SA1 (rear backplane signal connector) and BP_DST_SB1 (rear backplane signal connector)

PERC module

Removing the front mounting front PERC module

Prerequisites

1. Follow the safety guidelines listed in the [Safety instructions](#).
2. Follow the procedure listed in the [Before working inside your system](#).

3. [remove the backplane cover](#).
4. If installed, [remove the air shroud](#).
5. Disconnect all the cables, observe the cable routing.

Steps

1. Using a Phillips #2 screwdriver, loosen the captive screws on the front PERC module.
2. Slide and pull the front PERC module to disengage from the connector on the drive backplane.

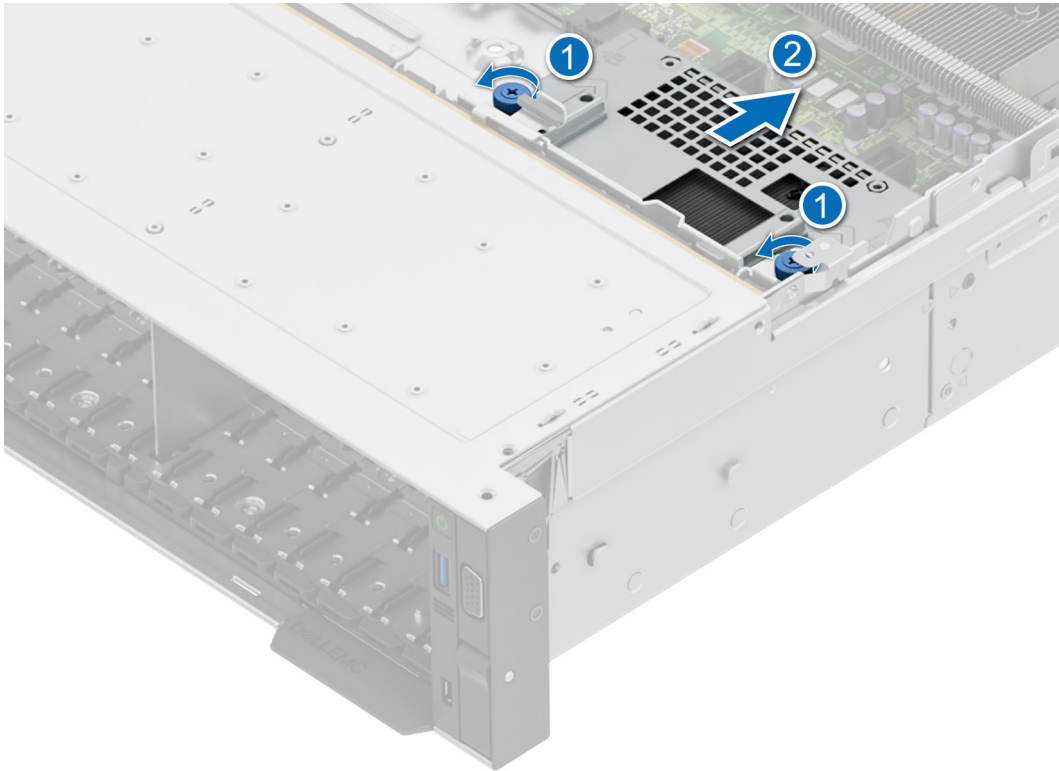

Figure 104. Removing the front mounting front PERC module

Next steps

1. [Replace the front mounting front PERC module](#).

Installing the front mounting front PERC module

Prerequisites

1. Follow the safety guidelines listed in the [Safety instructions](#).
2. Follow the procedure listed in [Before working inside your system](#).
3. [Remove the backplane cover](#).
4. If installed, [remove the air shroud](#).
5. Route the cable properly to prevent the cable from being pinched or crimped.

Steps

1. Align the front PERC module at an angle until the tray touches the slot in the system.
2. Slide and press the front PERC module connector with the connector on the drive backplane until firmly seated.
3. Using a Phillips #2 screwdriver, tighten the captive screws on the front PERC module.

NOTE: The numbers on the image do not depict the exact steps. The numbers are for representation of sequence.

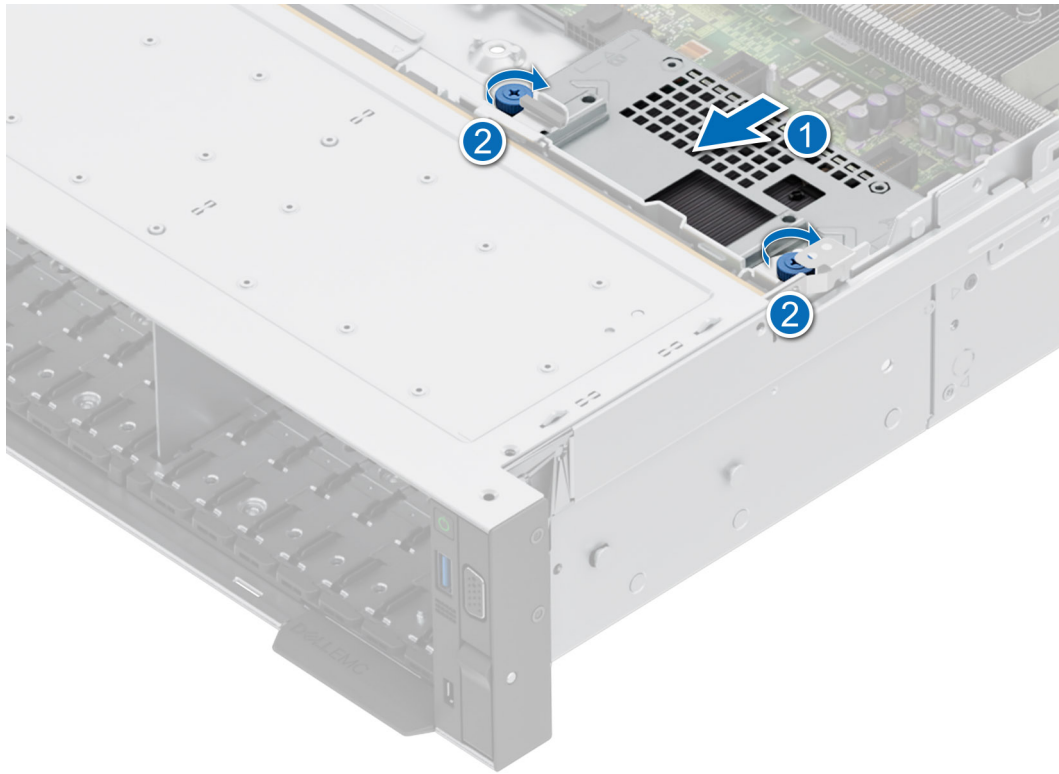

Figure 105. Installing the front mounting front PERC module

Next steps

1. Reconnect all the required cables.
2. If removed, [install the air shroud](#).
3. [Install the drive backplane cover](#).
4. Follow the procedure listed in [After working inside your system](#).

Removing the adapter PERC module

Prerequisites

1. Follow the safety guidelines listed in the [Safety instructions](#).
2. Follow the procedure listed in the [Before working inside your system](#).
3. If required, [remove the air shroud](#) or [remove the GPU air shroud](#).
4. If required, [remove the drive backplane cover](#).
5. [Remove the cooling fan cage assembly](#).
6. [Remove the expansion card riser](#).
7. Disconnect all the cables from the Adapter PERC card, observe the cable routing.

NOTE: Refer [cable routing](#) topic for more information.

NOTE: Adapter PERC module must be installed only in expansion card riser 1 or riser 2.

Steps

1. Tilt the expansion card retention latch lock to open.
2. Pull the card holder before removing the card from the riser.
3. Hold the Adapter PERC module by the edges, and pull the module from the expansion card connector on the riser.

NOTE: The numbers on the image do not depict the exact steps. The numbers are for representation of sequence.

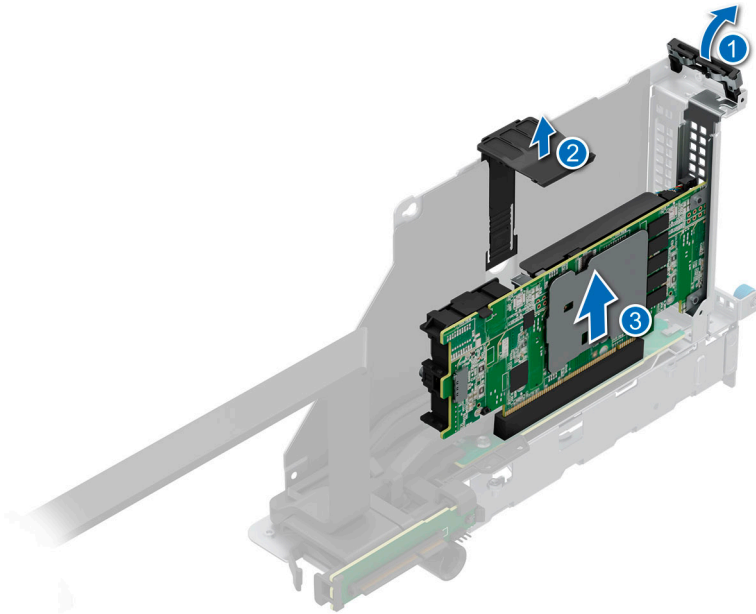

Figure 106. Removing the Adapter PERC module

4. If the Adapter PERC module is not going to be replaced, install a filler bracket and close the card retention latch.

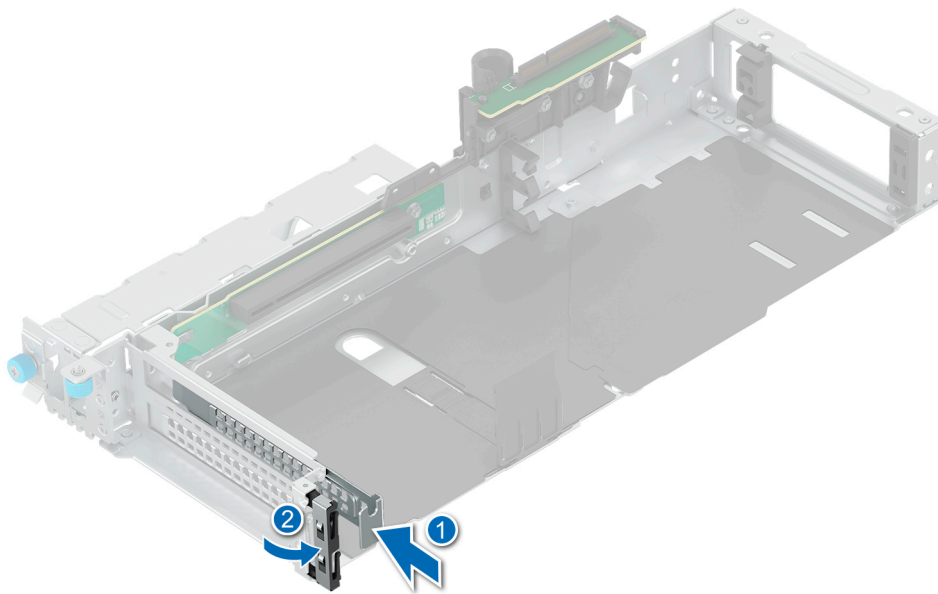

Figure 107. Installing the filler bracket

Next steps

1. [Replace the Adapter PERC module.](#)

Installing the adapter PERC module

Prerequisites

1. Follow the safety guidelines listed in the [Safety instructions](#).

2. Follow the procedure listed in [Before working inside your system](#).
3. If required, [remove the air shroud](#) or [remove the GPU air shroud](#).
4. If required, [remove the drive backplane cover](#).
5. [Remove the cooling fan cage assembly](#).
6. [Remove the expansion card riser](#).
7. Disconnect all the cables from the adapter PERC card, observe the cable routing.
 - i** **NOTE:** Refer [cable routing](#) topic for more information.
8. If a new APERC module has to be installed, unpack it and prepare the module for installation.
 - i** **NOTE:** For instructions, see the documentation accompanying the card.
 - i** **NOTE:** APERC module must be installed only in expansion card riser 1 or riser 2.

Steps

1. Pull and lift up the expansion card retention latch lock to open.
2. If installed, remove the filler bracket.
 - i** **NOTE:** Store the filler bracket for future use. Filler brackets must be installed in empty expansion card slots to maintain Federal Communications Commission (FCC) certification of the system. The brackets also keep dust and dirt out of the system and aid in proper cooling and airflow inside the system.

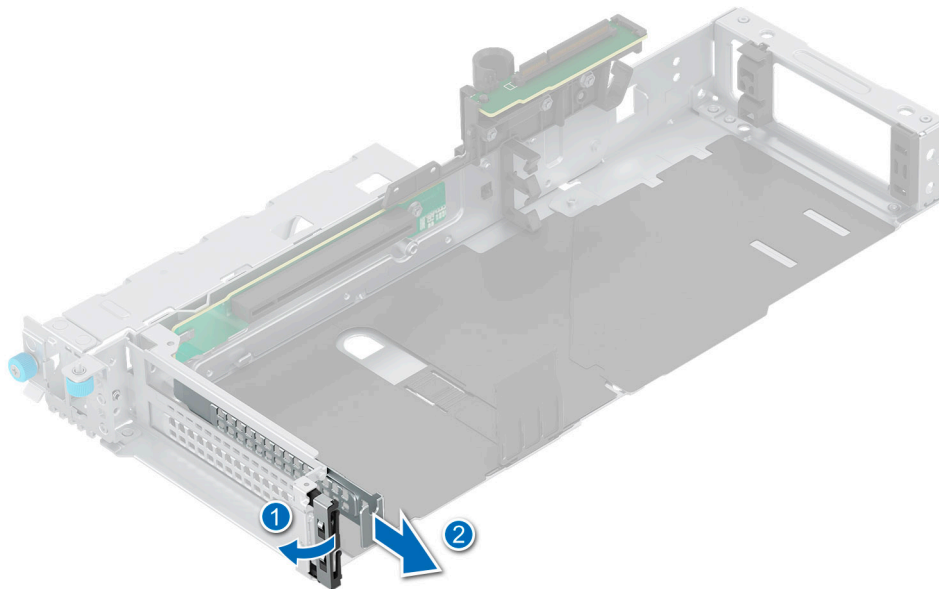

Figure 108. Removing the filler bracket

3. Hold the Adapter PERC module by the edges, and align the module edge connector with the expansion card connector on the riser.
4. Insert the module into the expansion card connector until firmly seated.
5. Close the expansion card retention latch.
6. Push the card holder to hold the module in the riser.
 - i** **NOTE:** The numbers on the image do not depict the exact steps. The numbers are for representation of sequence.

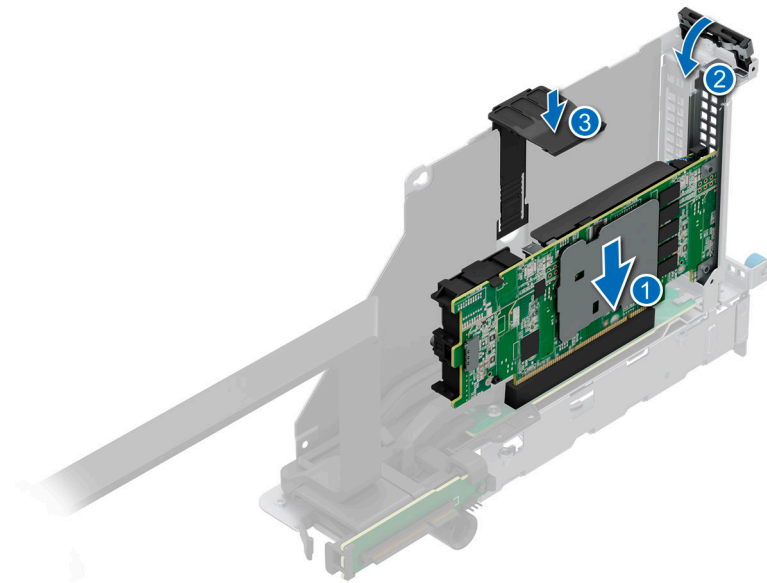

Figure 109. Installing the Adapter PERC module

Next steps

1. Connect the cables to the Adapter PERC module and route the cables properly.
i **NOTE:** Refer [cable routing](#) topic for more information.
2. Install the cooling fan cage assembly.
3. If removed, install the air shroud or install the GPU air shroud.
4. Install the drive backplane cover.
5. Install the expansion card riser.
6. Follow the procedure listed in [After working inside your system](#).

System memory

System memory guidelines

The PowerEdge R7625 system supports DDR5 registered DIMMs (RDIMMs).

Your system memory is organized into twelve channels per processor (one memory sockets per channel), 12 memory sockets per processor and 24 memory sockets per system.

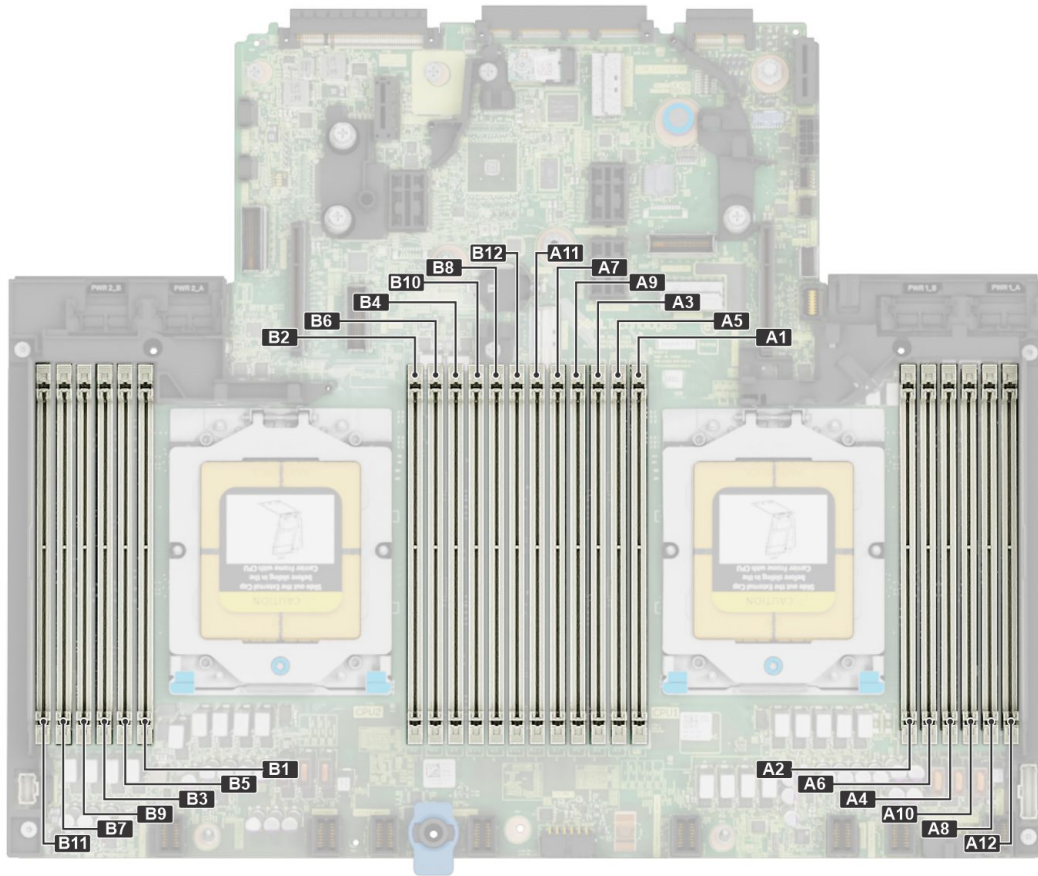

Figure 110. Memory channels

Memory channels are organized as follows:

Table 102. Memory channels

Processor	Channel A	Channel B	Channel C	Channel D	Channel E	Channel F
Processor 1	Slot A1	Slot A5	Slot A3	Slot A9	Slot A7	Slot A11
Processor 2	Slot B1	Slot B5	Slot B3	Slot B9	Slot B7	Slot B11

Table 103. Memory channels

Processor	Channel G	Channel H	Channel I	Channel J	Channel K	Channel L
Processor 1	Slot A2	Slot A6	Slot A4	Slot A10	Slot A8	Slot A12
Processor 2	Slot B2	Slot B6	Slot B4	Slot B10	Slot B8	Slot B12

Table 104. Supported memory matrix

DIMM type	Rank	Capacity	DIMM and speed	Operating Speed on AMD EPYC™ processor
				1 DIMM per channel (DPC)
RDIMM	1 R	16 GB	DDR5, 4800 MT/s	4800 MT/s
	2 R	32 GB, 64 GB	DDR5, 4800 MT/s	4800 MT/s
	4 R	128 GB	DDR5, 4800 MT/s	4800 MT/s
	8 R	256 GB	DDR5, 4800 MT/s	4800 MT/s

NOTE: DDR4 memory is not supported.

NOTE: The processor may reduce the performance of the rated DIMM speed.

General memory module installation guidelines

To ensure optimal performance of your system, observe the following general guidelines when configuring your system memory. If your system's memory configurations fail to observe these guidelines, your system might not boot, stop responding during memory configuration, or operate with reduced memory. This section provides information on the memory population rules for single or dual processor system.

The memory bus operate at speeds up to 4800 MT/s depending on the following factors:

- System profile selected (for example, Performance Optimized, or Custom [can be run at high speed or lower])
- Maximum supported DIMM speed of the processors
- Maximum supported speed of the DIMMs

NOTE: MT/s indicates DIMM speed in MegaTransfers per second.

The system supports memory configuration enabling the system to be configured and run in any valid chipset architectural configuration. The following are the recommended guidelines for installing memory modules:

- All DIMMs must be DDR5.
- Mixing different DIMM capacities is not supported.
- Mixing module types within a memory channel is not supported. All DIMMs populated must be RDIMM.
- If memory modules with different speeds are installed, they operate at the speed of the slowest installed memory module(s).
- Mixing different widths (x4 & x8) is not supported.
- Populate memory module sockets only if a processor is installed.
 - For single-processor systems, sockets A1 to A12 are available.
 - For dual-processor systems, sockets A1 to A12 and sockets B1 to B12 are available.
 - In Optimizer Mode, the DRAM controllers operate independently in the 64-bit mode and provide optimized memory performance.

Table 105. Memory population rules

Processor	Memory population	Memory population information
Dual processor (Start with processor1. Processor 1 and processor 2 population should match)	A{1}, B{1}, A{2}, B{2}, A{3}, B{3}, A{4}, B{4}, A{5}, B{5}, A{6}, B{6}, A{7}, B{7}, A{8}, B{8}, A{9}, B{9}, A{10}, B{10}, A{11}, B{11}, A{12}, B{12}	1,2,4,6,8,10 and 12 DIMM per processor allowed.

- In a dual-processor configuration, the memory configuration for each processor must be identical. For example, if you populate socket A1 for processor 1, then populate socket B1 for processor 2, and so on.
- Persistent memory will not be supported on Genoa based platforms.
- For best performance, populate all memory channels equally (12 DIMMs per CPU) using identical DIMMs.
- Unbalanced or odd memory configuration results in a performance loss and system may not identify the memory modules being installed, so always populate memory channels identically with equal DIMMs for best performance.
- Minimum recommended configuration is to populate 2, 4, 6, 8, 10, 12 equal memory modules per processor.
- Populate twelve equal memory modules per processor (one DIMM per channel) at a time to maximize performance.

NOTE: Equal memory modules refer to DIMMs with identical electrical specification and capacity that may be from different vendors.

Removing a memory module

Prerequisites

1. Follow the safety guidelines listed in the [Safety instructions](#).
2. Follow the procedure listed in the [Before working inside your system](#).
3. If installed, [remove the air shroud](#).

WARNING: The memory modules are hot to touch for some time after the system has been powered off. Allow the memory modules to cool before handling them. Handle the memory modules by the card edges and avoid touching the components or metallic contacts on the memory module.

Steps

1. Locate the appropriate memory module socket.
2. To release the memory module from the socket, simultaneously press the ejectors on both ends of the memory module socket.

CAUTION: Handle each memory module only by the card edges, ensuring not to touch the middle of the memory module or metallic contacts.

3. Lift the memory module away from the system.

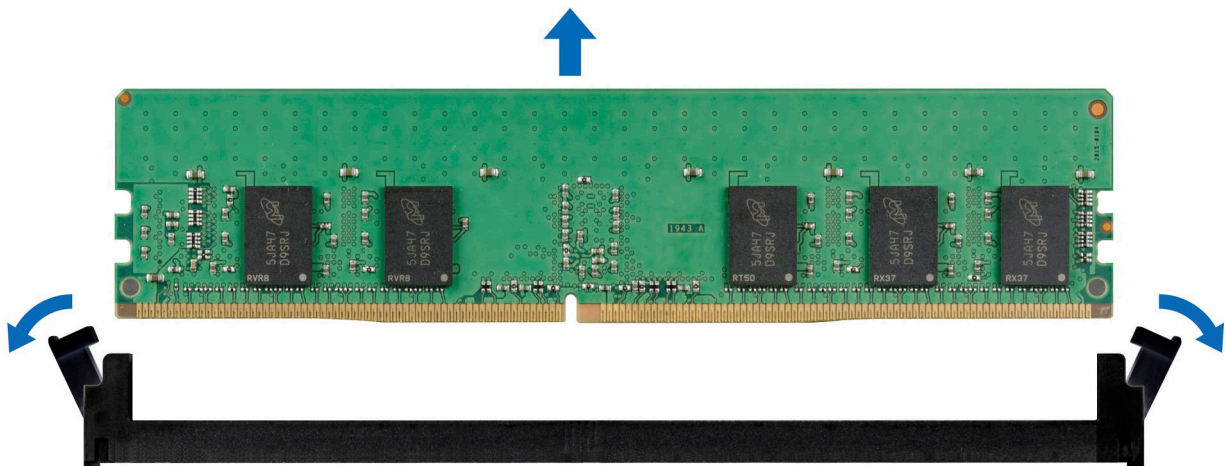

Figure 111. Removing a memory module

Next steps

1. [Replace the memory module](#), if you are removing a memory module permanently, install a memory module blank.

NOTE: The procedure to install a memory module blank is similar to the procedure to install a memory module.

NOTE: To ensure proper system cooling, memory module blanks must be installed in any memory socket that is not occupied. The memory module blanks compatible with the R7625 are DDR5 gray color blanks. Remove the memory module blanks only if you intend to install memory modules in those sockets.

Installing a memory module

Prerequisites

1. Follow the safety guidelines listed in the [Safety instructions](#).
2. Follow the procedure listed in [Before working inside your system](#).
3. If installed, [remove the air shroud](#).
4. If installed, remove a memory module blank.

NOTE: The procedure to remove a memory module blank is similar to the procedure to remove a memory module.

NOTE: Retain the removed memory module blank(s) for future use.

WARNING: The memory modules are hot to touch for some time after the system has been powered down. Allow the memory modules to cool before handling them. Handle the memory modules by the card edges and avoid touching the components or metallic contacts on the memory module.

Steps

1. Locate the appropriate memory module socket.

CAUTION: Handle each memory module only by the card edges, ensuring not to touch the middle of the memory module or metallic contacts.

2. If a memory module is installed in the socket, remove it.
3. Align the edge connector of the memory module with the alignment key of the memory module socket, and insert the memory module in the socket.

NOTE: Ensure the memory socket ejectors are fully open.

NOTE: The memory module socket has an alignment key that enables you to install the memory module in the socket in only one orientation.

CAUTION: Do not apply pressure at the center of the memory module; apply pressure at both ends of the memory module evenly.

CAUTION: To prevent damage to the memory module or the memory module socket during installation, do not bend or flex the memory module; insert both ends of the memory module simultaneously.

4. Press the memory module with your thumbs until the ejectors firmly click into place. When the memory module is properly seated in the socket, the levers on the memory module socket align with the levers on the other sockets that have memory modules installed.

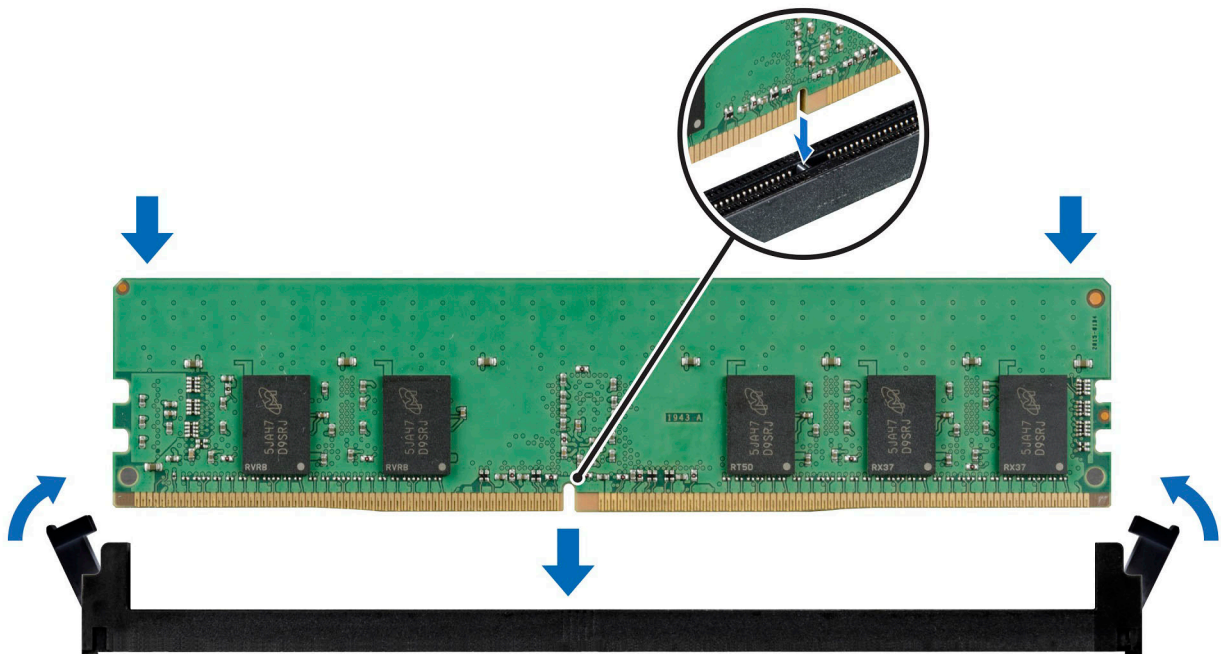

Figure 112. Installing a memory module

Next steps

1. If removed, [install the air shroud](#).
2. Follow the procedure listed in [After working inside your system](#).
3. To verify if the memory module has been installed properly, press F2 and navigate to **System Setup Main Menu > System BIOS > Memory Settings**. In the **Memory Settings** screen, the System Memory Size must reflect the updated capacity of the installed memory.
4. If the System Memory Size is incorrect, one or more of the memory modules may not be installed properly. Ensure that the memory modules are firmly seated in their sockets.
5. Run the system memory test in system diagnostics.

Processor and heat sink

Removing a heat sink

Prerequisites

1. Follow the safety guidelines listed in the [Safety instructions](#).
2. Follow the procedure listed in the [Before working inside your system](#).
3. If installed, [remove the air shroud](#).

⚠ WARNING: The heat sink and processor are too hot to touch for some time after the system has been powered off. Allow the heat sink and processor to cool down before handling them.

ℹ NOTE: The procedure to uninstall standard and L-type heat sink is similar.

Steps

1. Using a Torx #T20 screwdriver, fully loosen the captive screw all the way before moving to the next screw (on one-screw-at-a-time basis).

ℹ NOTE: Follow the screw sequence defined on the heat sink label. Disassembly order: 6, 5, 4, 3, 2, 1

ℹ NOTE: The captive screw numbers are marked on the heat sink.

2. Lift the heat sink from the system.

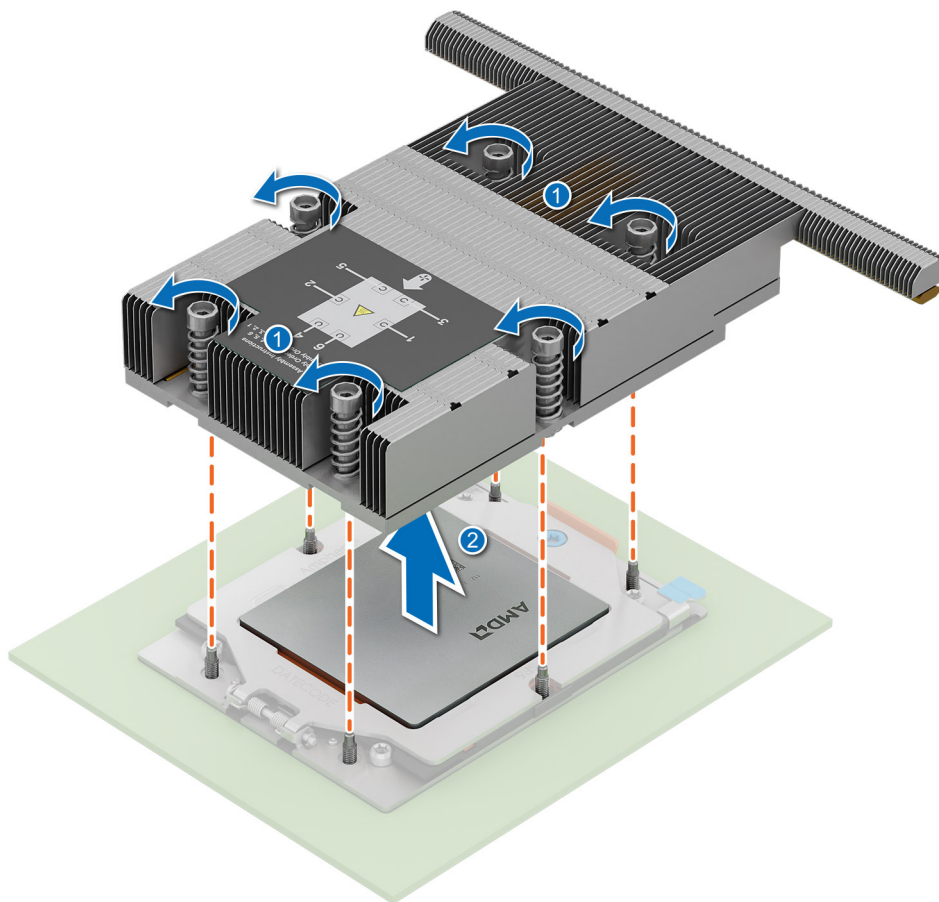

Figure 113. Removing a heat sink

Next steps

1. If you are uninstalling a faulty heat sink, [replace the heat sink](#), else [remove the processor](#).

Removing the Direct Liquid Cooling module

Prerequisites

1. Follow the safety guidelines listed in the [Safety instructions](#).
2. Follow the procedure listed in the [Before working inside your system](#).
3. If installed, [remove the air shroud](#).

 **WARNING: The Direct liquid cooling (DLC) module and processor are too hot to touch for some time after the system has been powered off. Allow the liquid cooling module and processor to cool down before handling them.**

 **NOTE:** Rear I/O (RIO) board is different for the system with DLC module.

Steps

1. Using a Phillips #2 screw driver, loosen the captive screw on the DLC ring holder.
2. Tilt the DLC ring holder to loosen the DLC tubes.
3. Disconnect the DLC leak detection cable from the LC RIO board.

 **NOTE:** The numbers on the image do not depict the exact steps. The numbers are for representation of sequence.

4. Remove the DLC tubes from the clip and LC RIO board.
5. Slightly lift the DLC tubes surrounding the DIMM slots.
6. Using a Torx #T20 screwdriver, fully loosen the captive screw all the way before moving to the next screw (on one-screw-at-a-time basis).

 **NOTE:** Follow the screw sequence defined on the heat sink label. Disassembly order: 6, 5, 4, 3, 2, 1.

 **NOTE:** Ensure the anti-tilt wires on the DLC module are in locked position when loosening the captive screws.

7. Set the anti-tilt wires on the DLC module to the unlock position and lift the DLC module from the system.

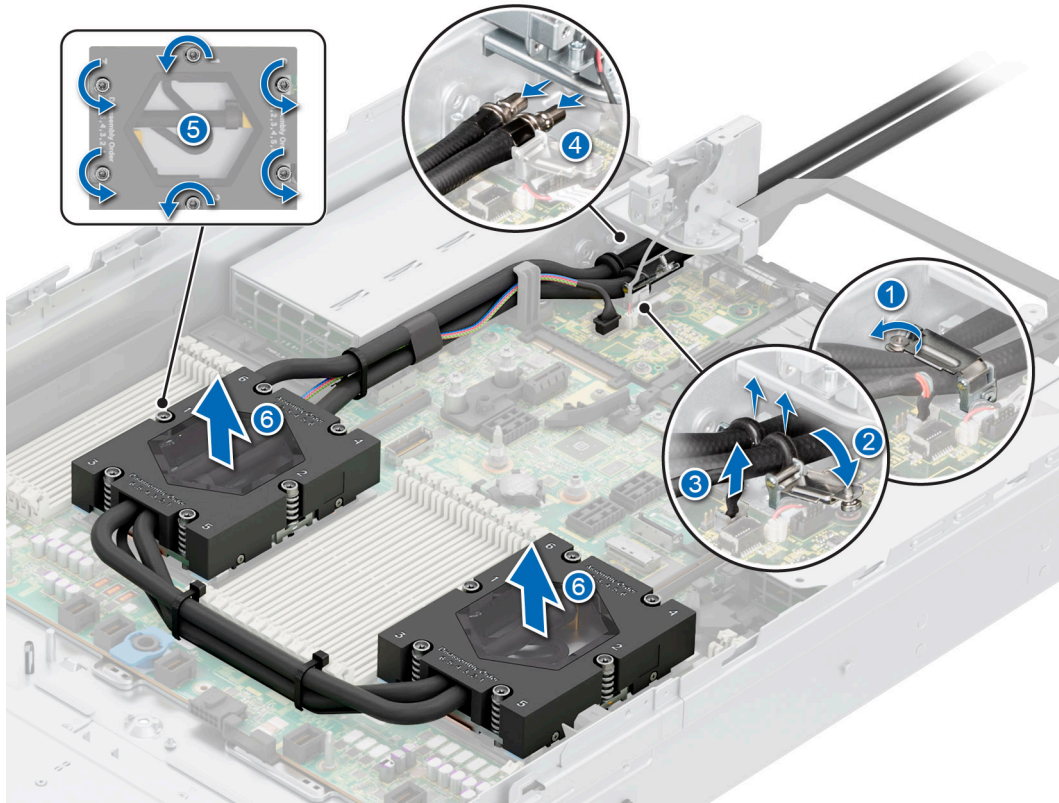

Figure 114. Removing the DLC module

Next steps

1. If you are uninstalling a faulty heat sink, [replace the Direct Liquid Cooling module](#), else [remove the processor](#).

Removing the processor

Prerequisites

⚠ WARNING: The heat sink may be hot to touch for some time after the system has been powered off. Allow the heat sink to cool before removing it.

1. Follow the safety guidelines listed in the [Safety instructions](#).
2. Follow the procedure listed in the [Before working inside your system](#).
3. [Remove the heat sink](#).

⚠ CAUTION: You may find the CMOS battery loss or CMOS checksum error is displayed during the first instance of powering on the system after the processor or system board replacement which is expected. To fix, go to [set up option](#) to configure the system settings.

Steps

1. Using a Torx #T20 screwdriver, loosen the middle screw to release the retention frame. Hold and lift the retention frame upwards and rotate it slightly past the vertical position(105 degrees).

(i) NOTE: The spring loading will keep the retention frame at its "open" position.

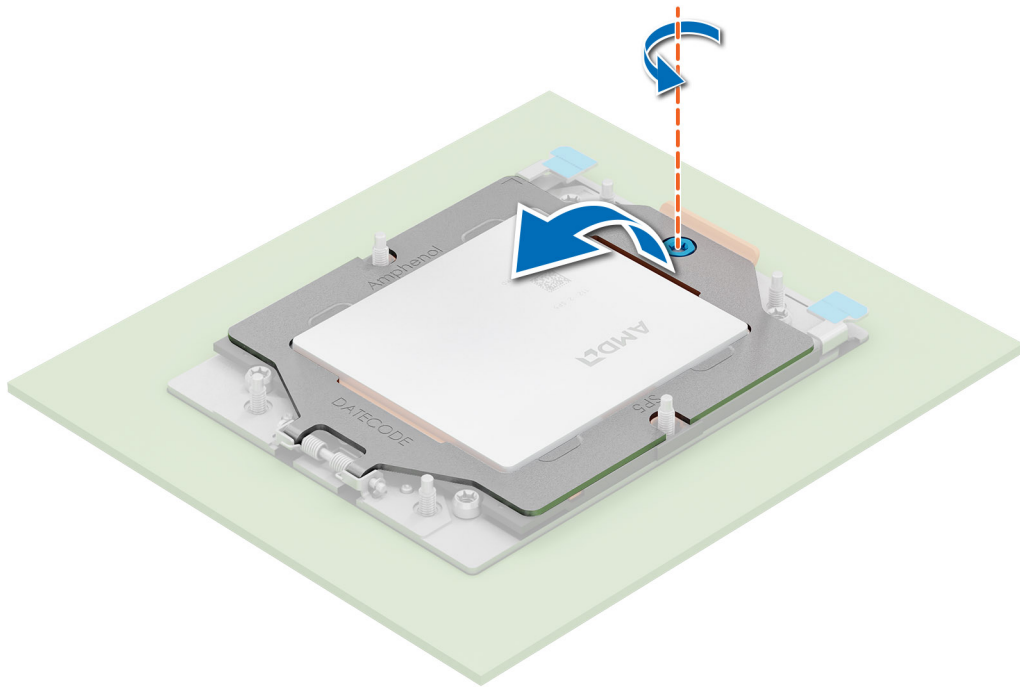

Figure 115. Removing screws on the retention frame

2. Release the processor socket rail frame by holding both blue tabs to lift the blue latches.

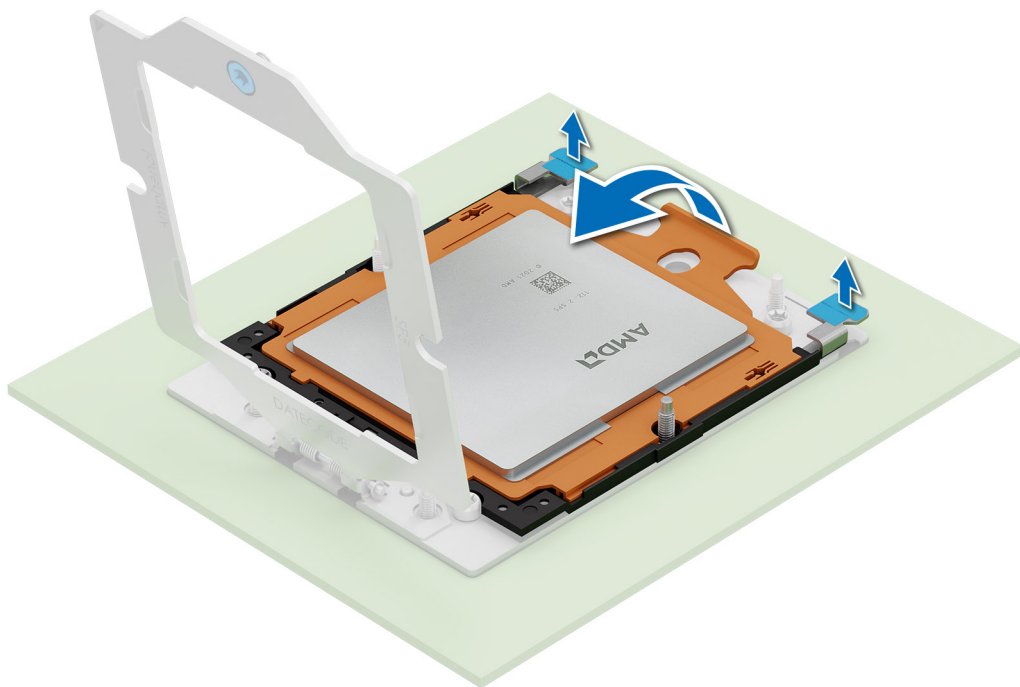

Figure 116. Lifting the rail frame

3. Holding the handle on the carrier frame, slide the tray out of the rail frame.

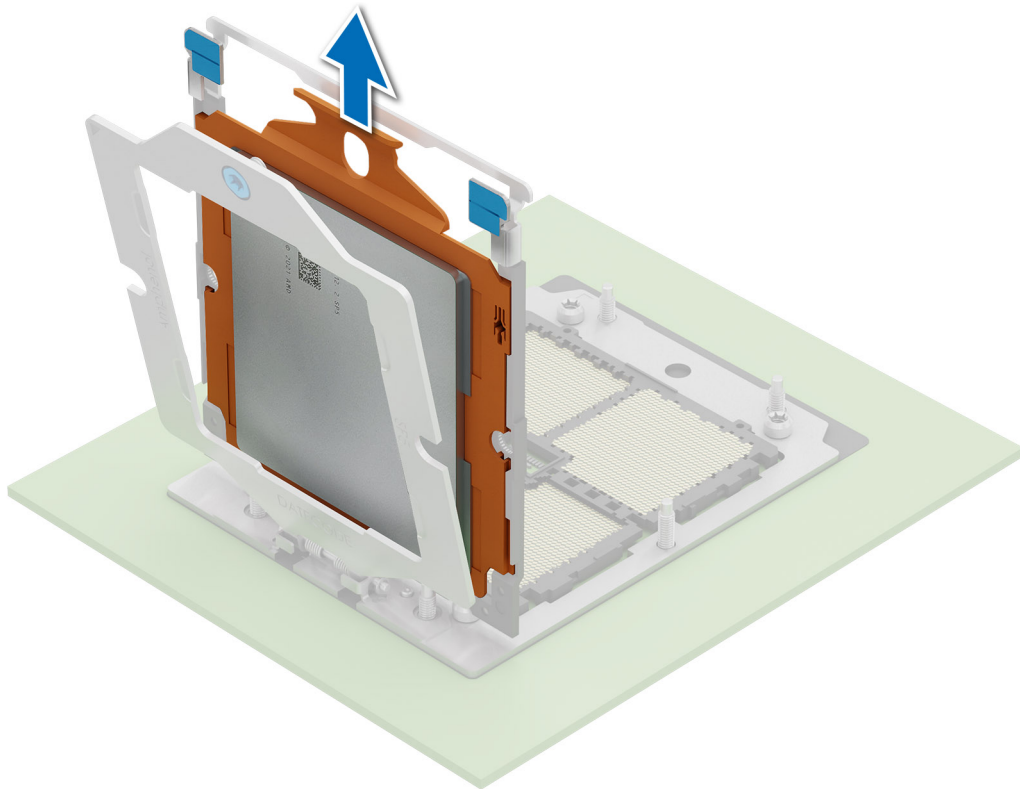

Figure 117. Removing the carrier frame

Next steps

1. [Replace the processor.](#)

Installing the processor

Prerequisites

1. Follow the safety guidelines listed in the [Safety instructions](#).
2. Follow the procedure listed in [Before working inside your system](#).
3. [Remove the heat sink.](#)

Steps

1. Holding the handle of the carrier frame, slide the tray into the processor socket rail frame until firmly seated.

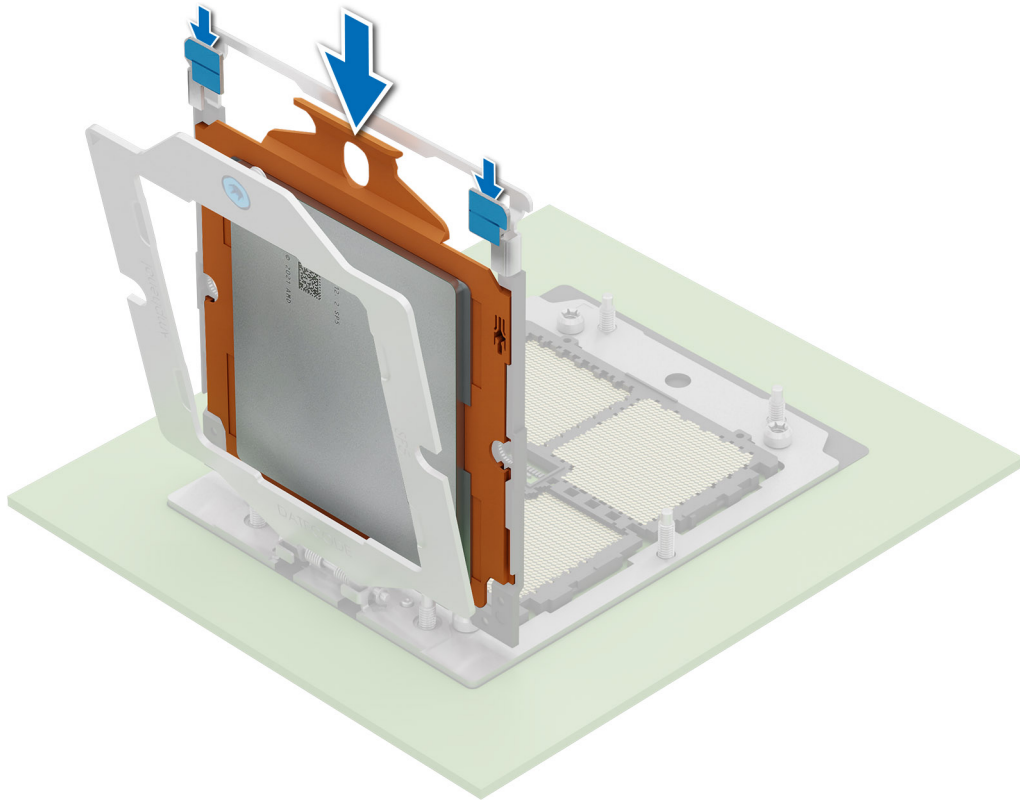

Figure 118. Placing the carrier frame into the rail frame

2. Holding both of blue tabs to push the rail frame down until the blue latches lock into place.

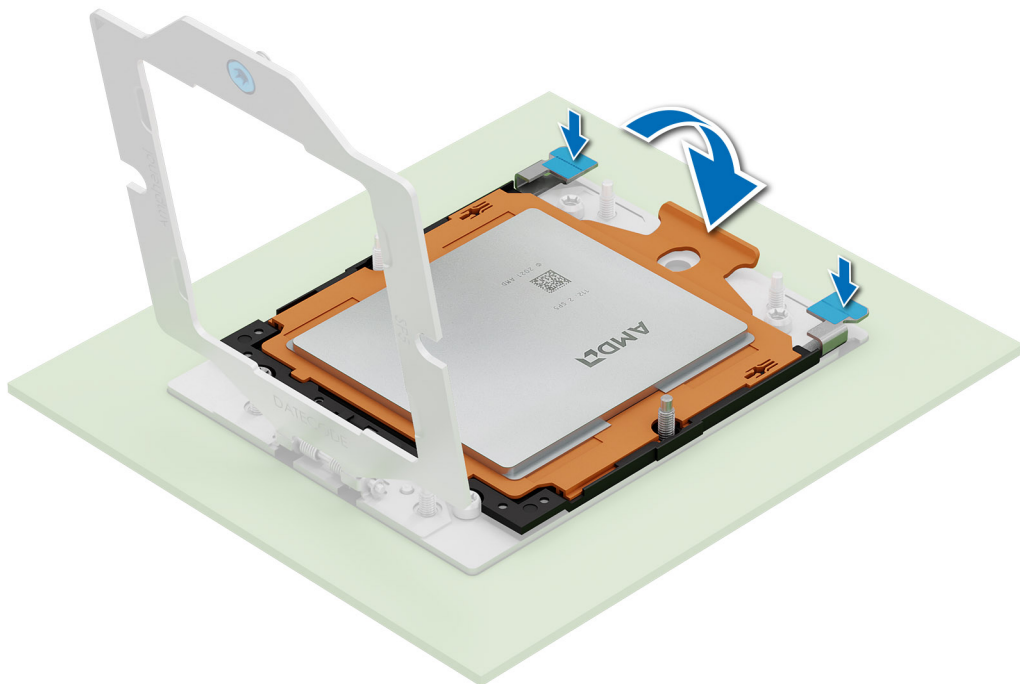

Figure 119. Closing the rail frame

3. Secure the retention frame by holding down the retention frame with one hand while using the other hand to operate the screw driver to engage and tighten screw.

NOTE: Press the retention frame while tightening the screws to avoid tilting of the processor cover out of the processor socket.

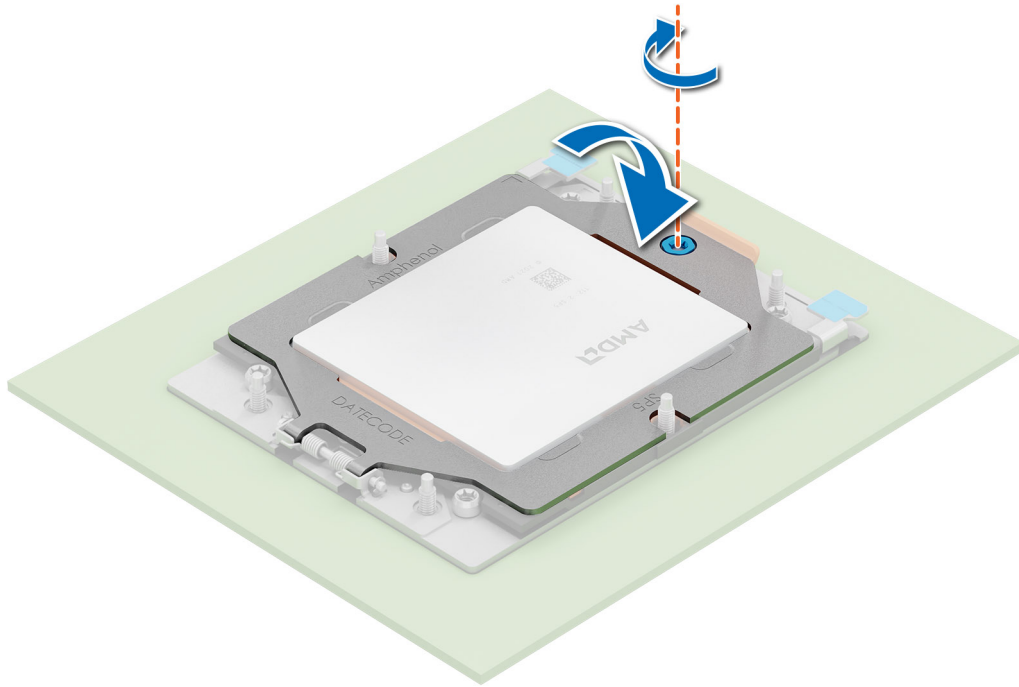

Figure 120. Securing the retention frame

Next steps

1. [Install the heat sink.](#)
2. Follow the procedure listed in [After working inside your system.](#)

Installing the heat sink

Prerequisites

Never uninstall the heat sink from a processor unless you intend to replace the processor or system board. The heat sink is necessary to maintain proper thermal conditions.

1. Follow the safety guidelines listed in the [Safety instructions.](#)
2. Follow the procedure listed in the [Before working inside your system.](#)
3. If installed, [remove the air shroud.](#)
4. If installed, remove the processor dust cover.

NOTE: The procedure to install standard and L-type heat sink is similar.

Steps

1. If you are using an existing heat sink, remove the thermal grease on the heat sink by using a clean lint-free cloth.

NOTE: For a new heat sink, the thermal paste is pre-applied to the heat sink. Remove the protective cover, and install the heat sink.

2. Use the thermal grease syringe included with your processor kit to apply the grease in a thin spiral on the top of the processor.

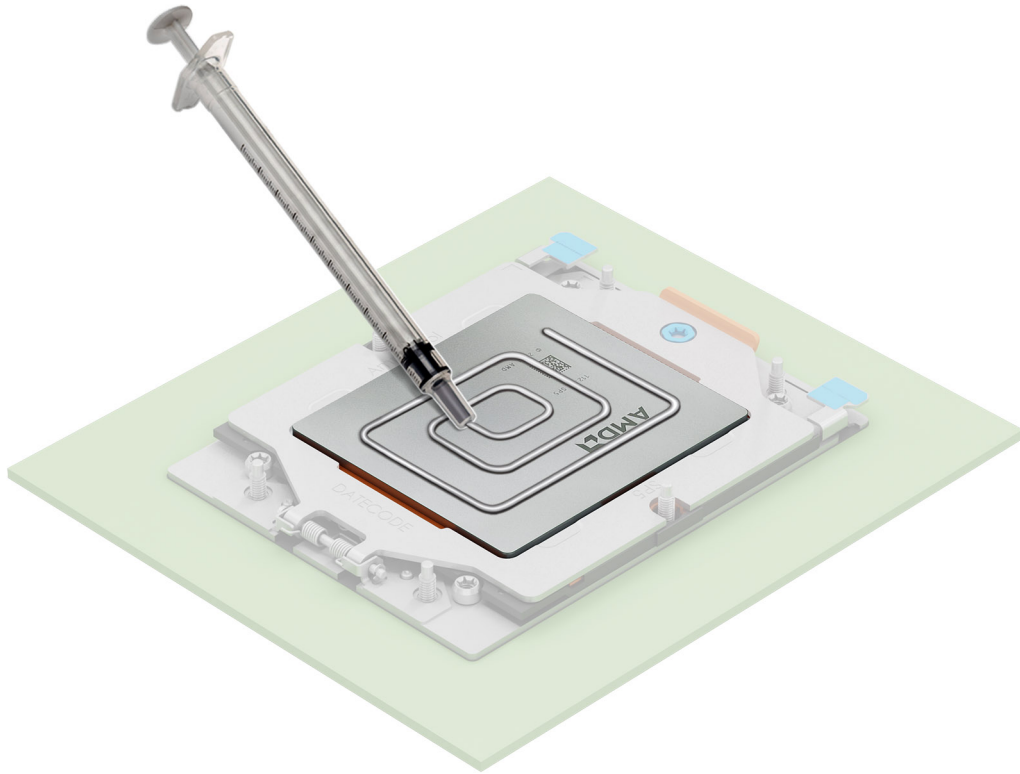

Figure 121. Applying thermal grease

CAUTION: Applying too much thermal grease can result in excess grease coming in contact with and contaminating the processor socket.

NOTE: The thermal grease syringe is intended for single use only. Dispose of the syringe after you use it.

NOTE: Refer to the airflow direction on heat sink label as visual hint of heat sink install orientation.

3. Align the screws on the heat sink with the standoff screws on the system board.

NOTE: The A1 extrusion on the L-type heat sink should face towards the system side.

4. Using a Torx #T20 screwdriver, fully tighten the captive screw all the way down before moving to the next screw (on one-screw-at-a-time basis).

NOTE: Follow the screw sequence defined on heat sink label. Assembly order: 1, 2, 3, 4, 5, 6

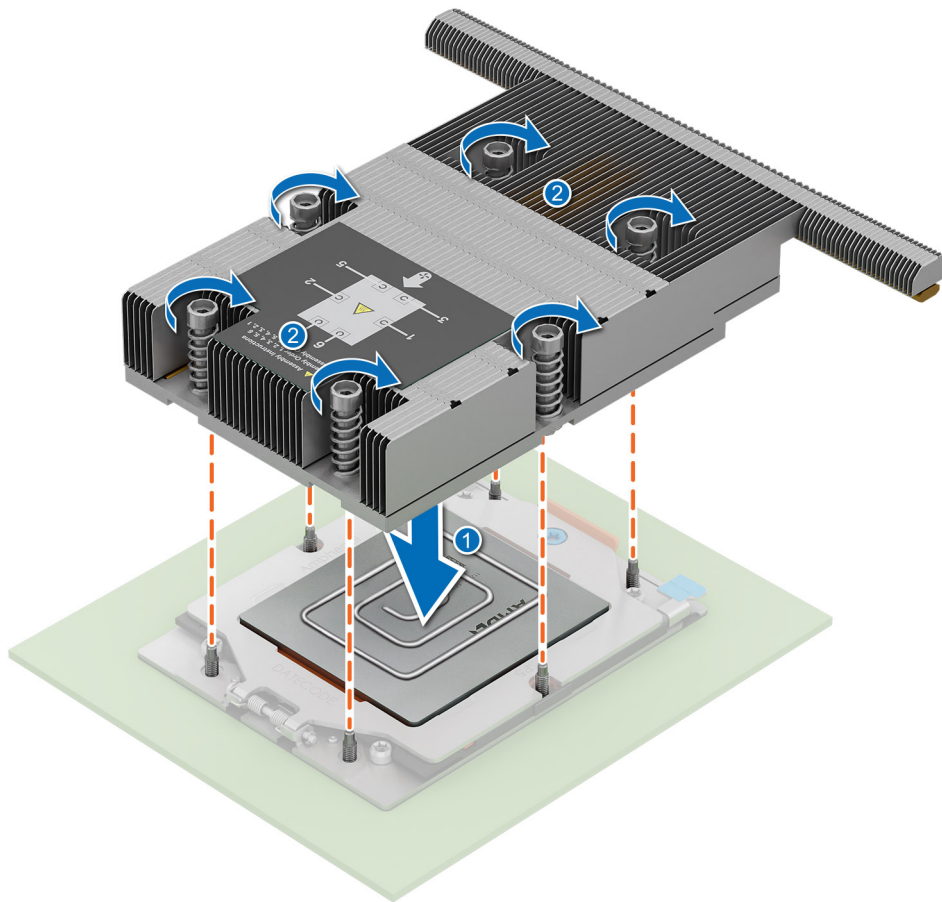

Figure 122. Installing the heat sink

Next steps

1. If removed, [install the air shroud](#).
2. Follow the procedure listed in the [After working inside your system](#).

Installing the Direct Liquid Cooling module

Prerequisites

Never uninstall the heat sink from a processor unless you intend to replace the processor or system board. The heat sink is necessary to maintain proper thermal conditions.

1. Follow the safety guidelines listed in the [Safety instructions](#).
2. Follow the procedure listed in the [Before working inside your system](#).
3. If installed, [remove the air shroud](#).
4. If installed, remove the processor dust cover.
5. For new heat sinks, refer to [Installing the heat sink](#) step 1 and 2 for applying the thermal grease.

i **NOTE:** Ensure anti-tilt wires on the DLC module are in the unlocked position.

i **NOTE:** The recommended maximum operating pressure is 15 psi (diverter opens at 15 psi).

Steps

1. Align the DLC module with the standoff screws on the system board.

i **NOTE:** Ensure that the DLC tubes and liquid cooling leak detection cable are placed towards the rear of the system.

2. Place the module on the processor slot and set all the anti-tilt wires to locked position (outward position).
 3. Route the DLC tubes to the front of the system and along the DIMM latches.
 4. Using a Torx #T20 screwdriver, fully tighten the captive screw all the way down before moving to the next screw (on one-screw-at-a-time basis).
- NOTE:** Follow the screw sequence defined on heat sink label. Assembly order: 1, 2, 3, 4, 5, 6.
5. The tubes leading towards the rear of the chassis and the DLC leak detection cable are placed in between the PSU 2 and the clip of rear I/O board (RIO).
- NOTE:** Leak detection cable must be placed first into the clip (underneath the cooling tubes), and then place tube 2 and tube 1 into the clip to ensure that cable does not interfere with the PCIe risers.
6. Route the rear end of the DLC tubes through the RIO board.
- NOTE:** Follow the number labels on the DLC tubes and ring holders (1,2).
7. Connect the DLC leak detection cable to the connector on RIO.
 8. Align the rubber ring on the tubes with the ring holder.
 9. Tilt the DLC ring holder and using a Phillips #2 screwdriver, tighten the captive screw on the DLC ring holder to secure it in place.

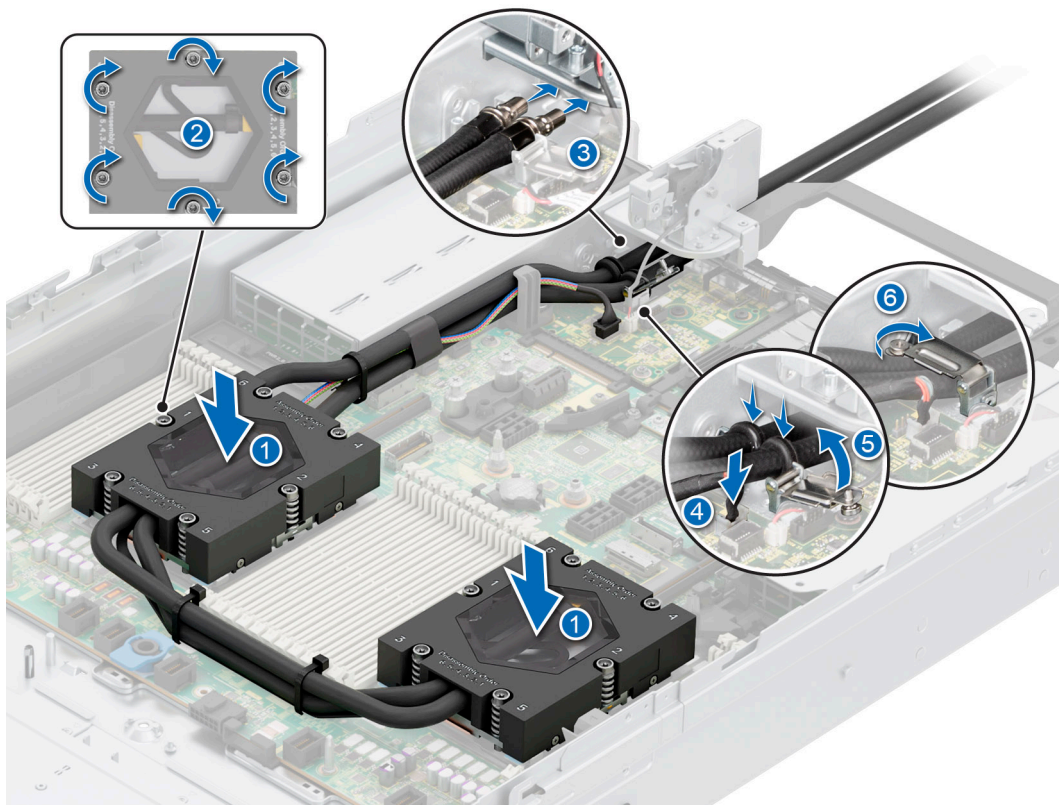

Figure 123. Installing the liquid cooling heat sink

Next steps

1. If removed, [install the air shroud](#).
2. Follow the procedure listed in the [After working inside your system](#).

Expansion cards and expansion card risers

NOTE: A system event entry is logged in the iDRAC Lifecycle Controller if an expansion card riser is not supported or missing. It does not prevent your system from turning on. However, if a F1/F2 pause occurs with an error message, see *Troubleshooting expansion cards* section in the *Dell PowerEdge Servers Troubleshooting Guide* at www.dell.com/poweredgemanuals.

Expansion card installation guidelines

The following table describes the supported expansion cards:

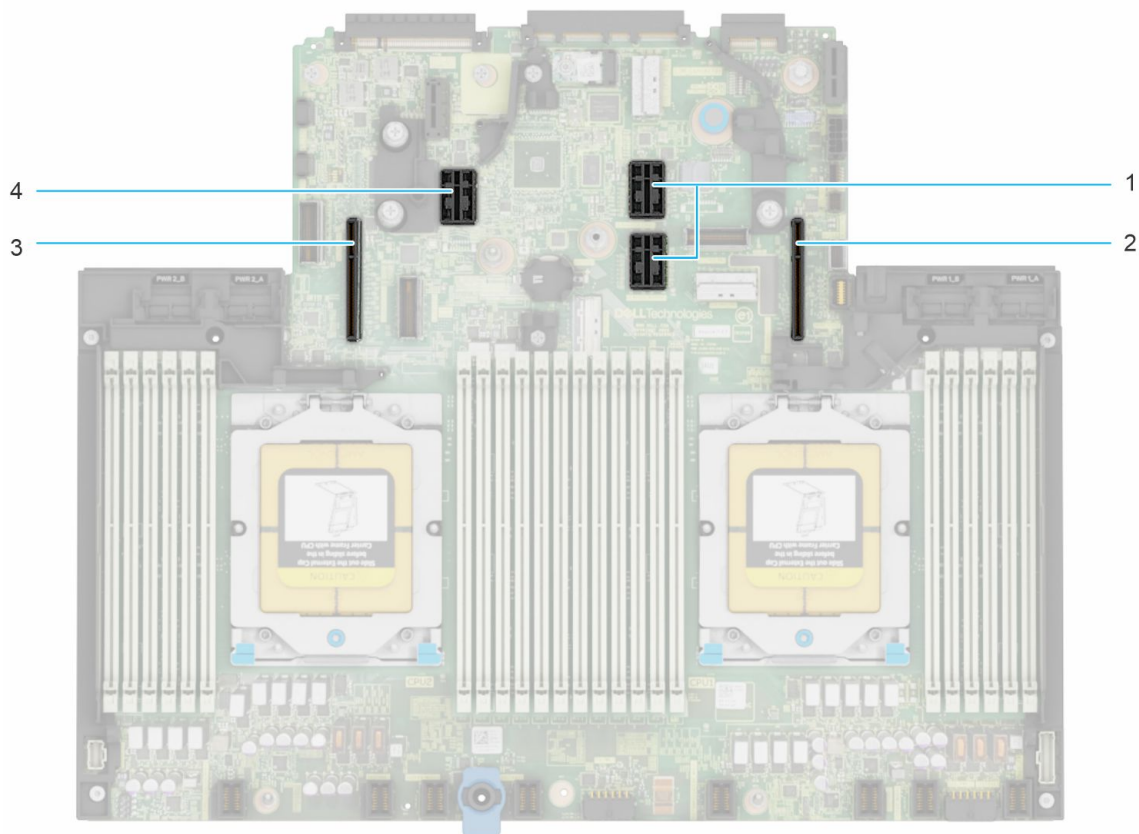

Figure 124. Expansion card riser slot connectors

- 1. Riser 2
- 2. Riser 1
- 3. Riser 4
- 4. Riser 3

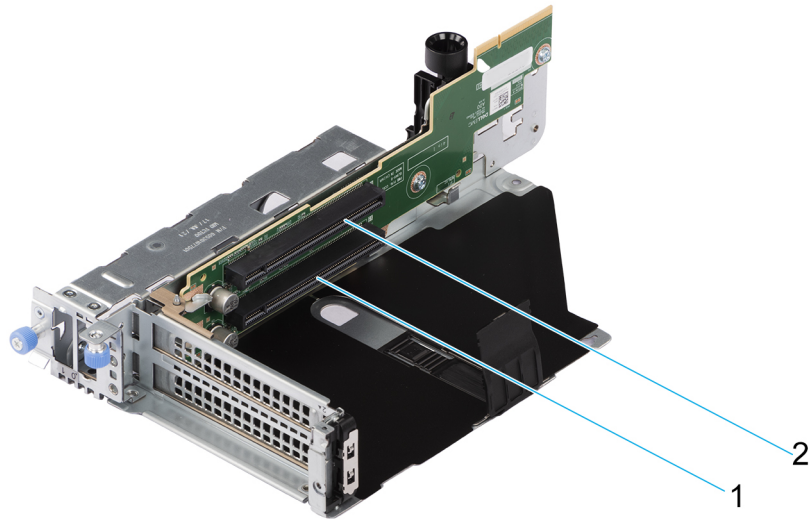

Figure 125. Riser 1B

1. Slot 1
2. Slot 2

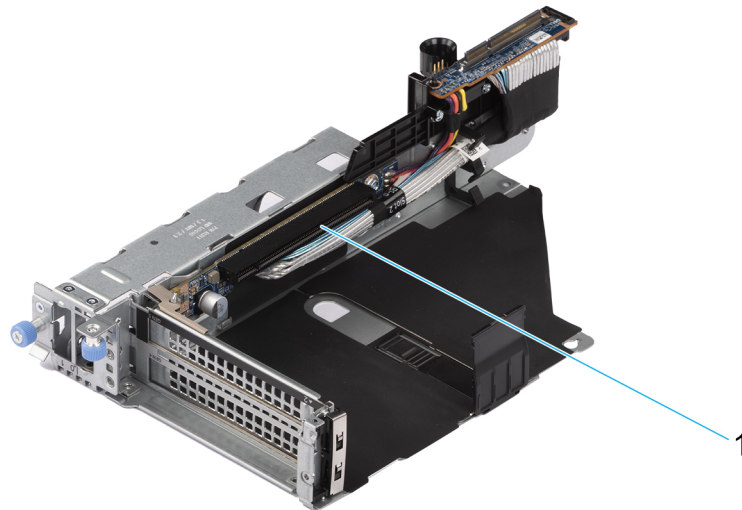

Figure 126. Riser 1P HL

1. Slot 2

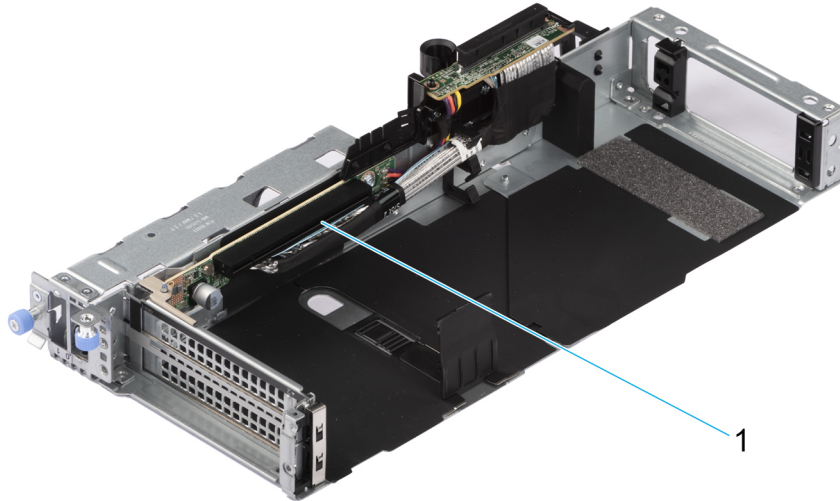

Figure 127. Riser 1P FL

1. Slot 2

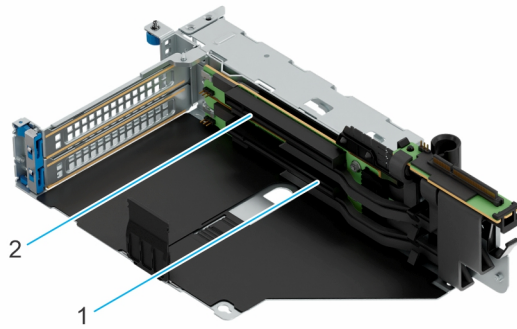

Figure 128. Riser 1Q

1. Slot 1
2. Slot 2

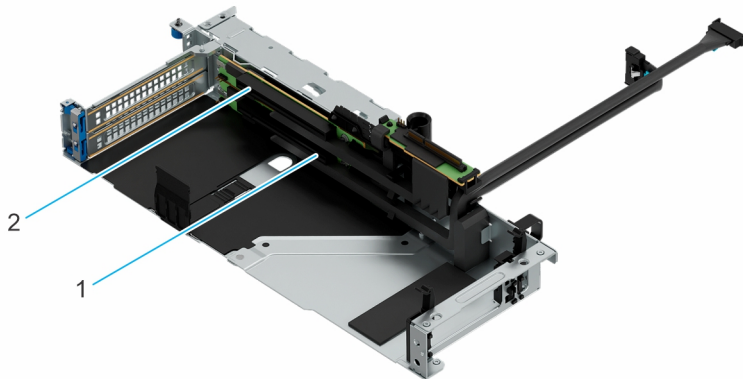

Figure 129. Riser 1S FL

1. Slot 1
2. Slot 2

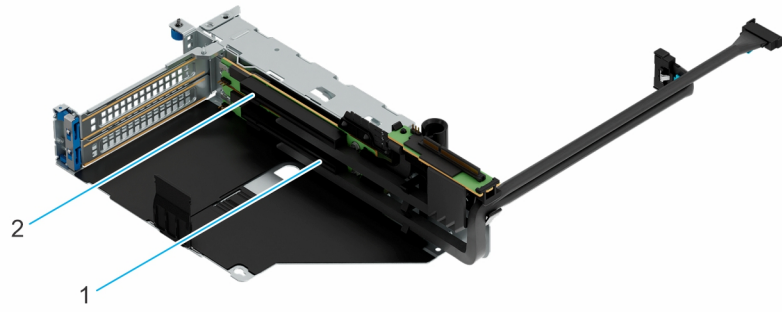

Figure 130. Riser 1S HL

- 1. Slot 1
- 2. Slot 2

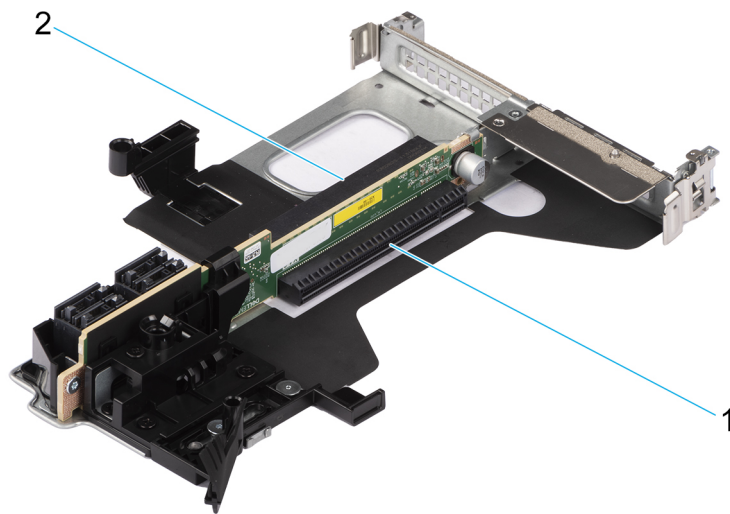

Figure 131. Riser 2A

- 1. Slot 6
- 2. Slot 3

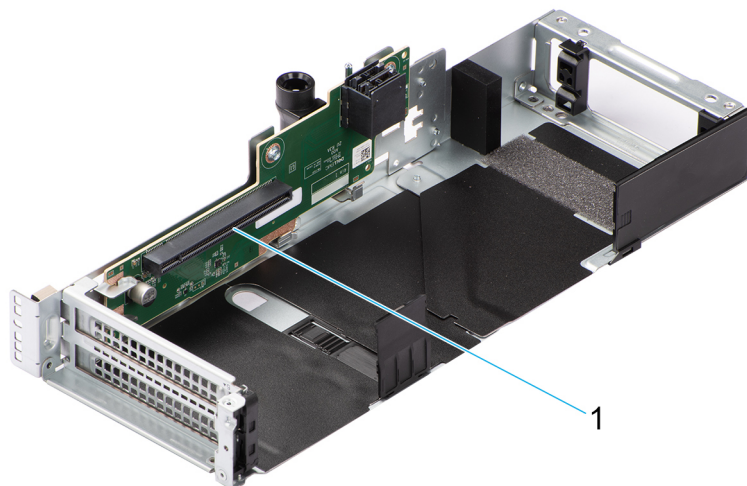

Figure 132. Riser 3A FL

- 1. Slot 5

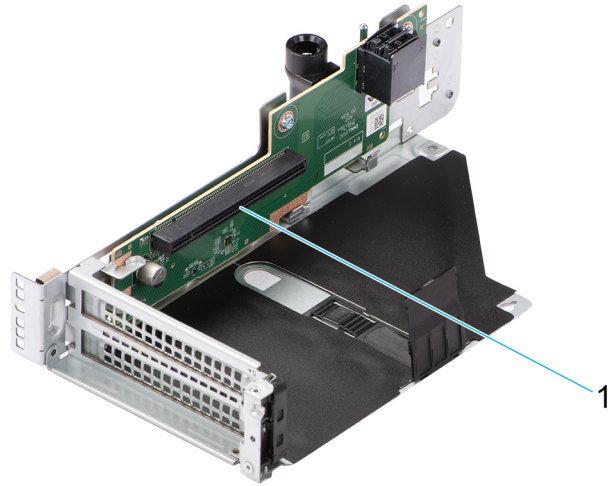

Figure 133. Riser 3A HL

1. Slot 5

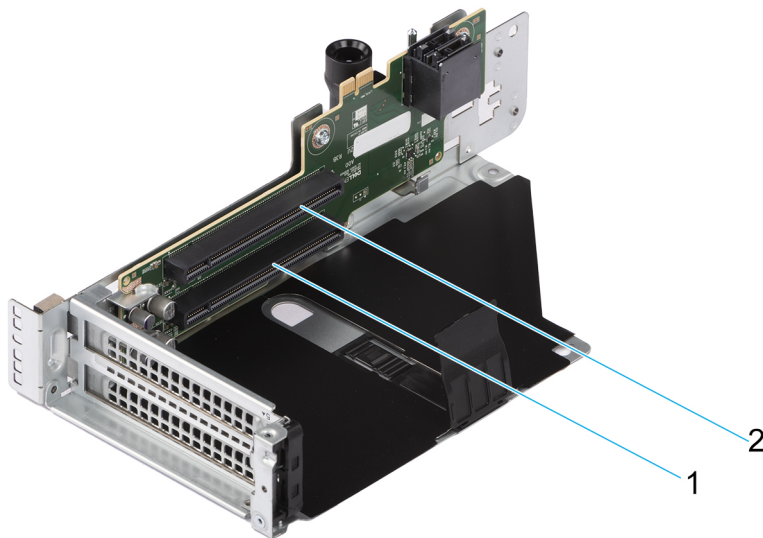

Figure 134. Riser 3B

1. Slot 4
2. Slot 5

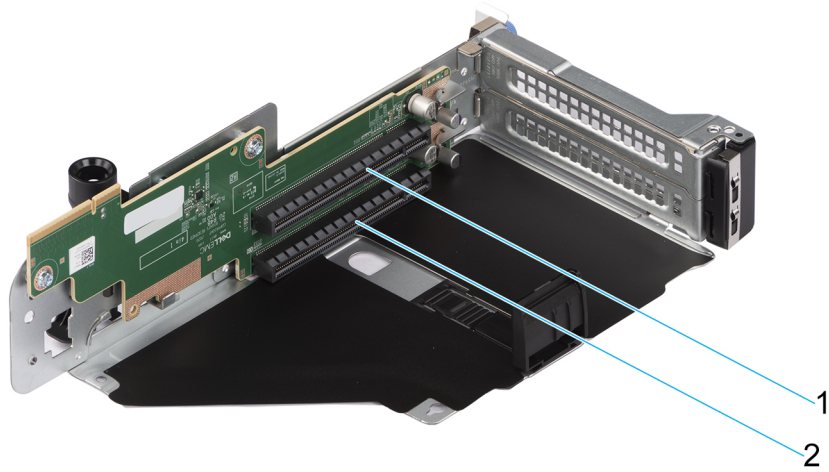

Figure 135. Riser 4B

- 1. Slot 8
- 2. Slot 7

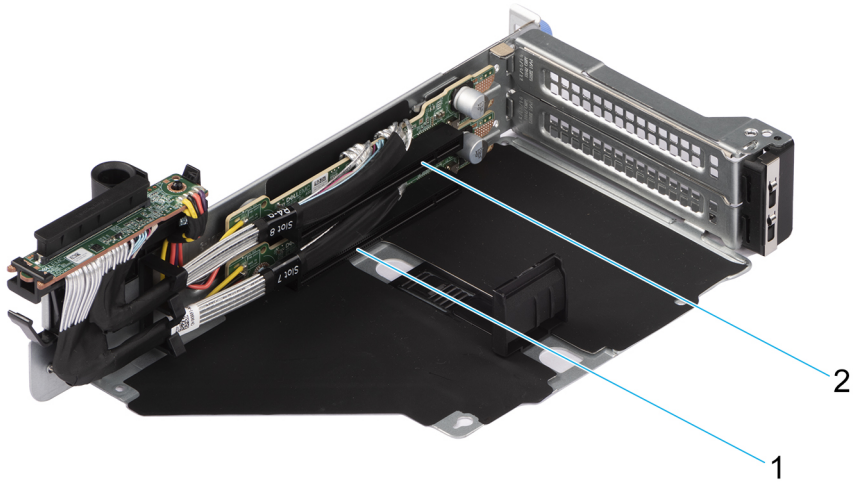

Figure 136. Riser 4Q

- 1. Slot 7
- 2. Slot 8

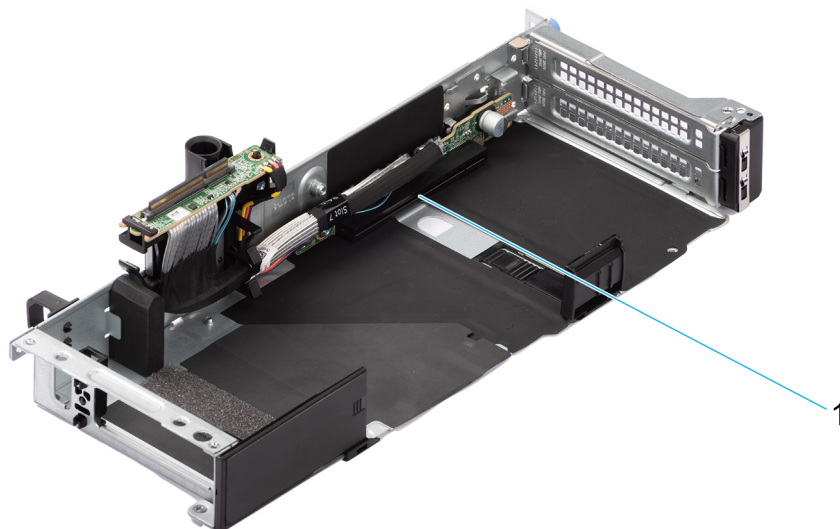

Figure 137. Riser 4P FL

1. Slot 7

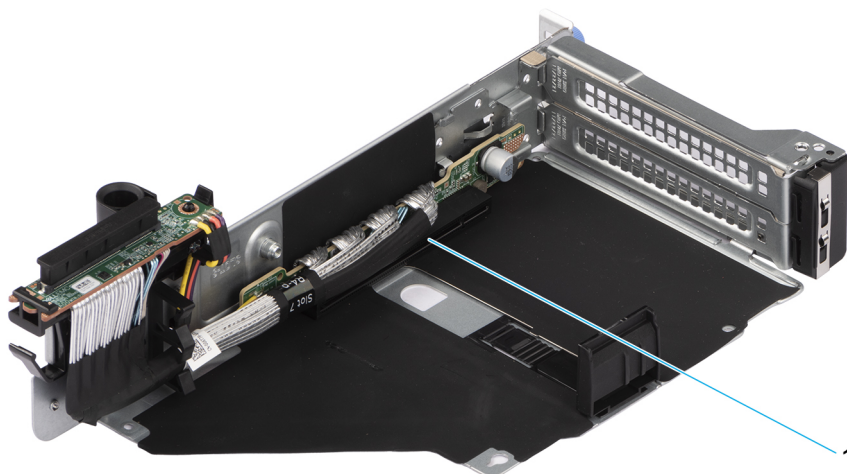

Figure 138. Riser 4P HL

1. Slot 7

NOTE: The expansion-card slots are not hot-swappable.

The following table provides guidelines for installing expansion cards to ensure proper cooling and mechanical fit. The expansion cards with the highest priority should be installed first using the slot priority indicated. All the other expansion cards should be installed in the card priority and slot priority order.

Table 106. Expansion card riser configurations

Expansion card riser	PCIe slots	Processor connection	Height	Length	Slot width
Riser 1B	Slot 1	Processor 1	Full Height	Half Length	x8
	Slot 2				
Riser 1P	Slot 2	Processor 1	Full Height	Half Length / Full Length	x16
Riser 1Q	Slot 1	Processor 1	Full Height	Half Length	x8
	Slot 2				

Table 106. Expansion card riser configurations (continued)

Expansion card riser	PCIe slots	Processor connection	Height	Length	Slot width
Riser 1S	Slot 1	Processor 1	Full Height	Half Length / Full Length	x16
	Slot 2				
Riser 2A	Slot 3	Processor 1	Low Profile	Half Length	x16
	Slot 6	Processor 2			
Riser 3A	Slot 5	Processor 2	Full Height	Half Length / Full Length	x16
Riser 3B	Slot 4	Processor 2	Full Height	Half Length	x8
	Slot 5				
Riser 4B	Slot 7	Processor 2	Full Height	Half Length	x8
	Slot 8				
Riser 4Q	Slot 7	Processor 2	Full Height	Half Length	x8
	Slot 8				
Riser 4P	Slot 7	Processor 2	Full Height	Half Length / Full Length	x16

Table 107. PCIe Riser Configs

Config #	RSR Configuration	# of CPUs	PERC type supported	Rear Storage Possible	x8 CPU 1	x16 CPU 1	x8 CPU 2	x16 CPU 2
0	0	2	Front PERC	No	0	0	0	0
1	R1B + R4B	2	Front PERC	No	2	0	2	0
2	R1B + R2A + R3B + R4B	2	Front PERC / Adaptor PERC	No	2	1	4	1
3	R1Q + R2A + R3B + R4Q	2	Front PERC / Adaptor PERC	No	2	1	4	1
4	R1P + R2A + R3B + R4P	2	Front PERC / Adaptor PERC	No	0	2	2	2
5	R1S + R2A + R3A + R4P	2	Front PERC	No	0	3	0	3
6	R2A + R4Q	2	Front PERC / Adaptor PERC	Yes	0	1	2	1
7	R1Q + R2A + R4Q	2	Front PERC / Adaptor PERC	Yes	2	1	2	1
8	U.2 R1 Paddle card + R2A + R3B + R4D Paddle card	2	No	No	0	2	2	2
9	R1B + R2A	1	Adaptor PERC	No	2	1	0	0
10	R2A + R3B	2	Front PERC / Adaptor PERC	Yes	0	1	2	1
11	R1-E3 Paddle card + R2A + R3B + 2U R4-E3 Paddle card	2	No	Yes	0	2	2	2

Table 107. PCIe Riser Configs (continued)

Config #	RSR Configuration	# of CPUs	PERC type supported	Rear Storage Possible	x8 CPU 1	x16 CPU 1	x8 CPU 2	x16 CPU 2
12	R1-E3X4 Paddle card+R2A+R3B+R4-E3 Paddle card	2	No	Yes	0	2	2	2
13	R1-E3 Paddle card+R2A+R3B+R4-SCMX4 Paddle card	2	No	Yes	0	2	2	2

NOTE: The expansion-card slots are not hot-swappable.

The following table provides guidelines for installing expansion cards to ensure proper cooling and mechanical fit. The expansion cards with the highest priority should be installed first using the slot priority indicated. All the other expansion cards should be installed in the card priority and slot priority order.

Table 108. Config0. No RSR

CARD TYPE	SLOT PRIORITY	MAXIMUM NUMBER OF CARDS
Inventec (LOM Card)	Integrated slot	1
Intel (OCP: 25Gb)	Integrated slot	1
Mellanox (OCP: 25Gb)	Integrated slot	1
Broadcom (OCP: 25Gb)	Integrated slot	1
Broadcom (OCP: 25Gb)	Integrated slot	1
Broadcom (OCP: 25Gb)	Integrated slot	1
Broadcom (OCP: 10Gb)	Integrated slot	1
Intel (OCP: 10Gb)	Integrated slot	1
Broadcom (OCP: 10Gb)	Integrated slot	1
Broadcom (OCP: 1Gb)	Integrated slot	1
Intel (OCP: 1Gb)	Integrated slot	1
Broadcom (OCP: 1Gb)	Integrated slot	1
FOXCONN (BOSS)	Integrated slot	1
FOXCONN (BOSS)	Integrated slot	1

Table 109. Config1. R1B+R4B

CARD TYPE	SLOT PRIORITY	MAXIMUM NUMBER OF CARDS
Inventec (Serial, FH)	8	1
NVIDIA (GPU A2, FH)	1,2,7,8	4
FOXCONN (FPERC H355)	Integrated slot	1
FOXCONN (FPERC HBA355I)	Integrated slot	1
External Adapter HBA465E, LP/FH	1,2,7,8	4
External Adapter H965e, LP/FH	1,2,7,8	4
Inventec (LOM Card)	Integrated slot	1
Intel (NIC: 100Gb, FH)	1,2,7,8	4

Table 109. Config1. R1B+R4B (continued)

CARD TYPE	SLOT PRIORITY	MAXIMUM NUMBER OF CARDS
Intel (NIC: 25Gb, FH)	1,2,7,8	4
Mellanox (NIC: 25Gb, FH)	1,2,7,8	4
Broadcom (NIC: 25Gb, FH)	1,2,7,8	4
Broadcom (HBA: FC64, FH)	1,2,7,8	4
Broadcom (HBA: FC32, FH)	1,2,7,8	4
Marvell (HBA: FC32, FH)	1,2,7,8	4
Broadcom (NIC: 10Gb, FH)	1,2,7,8	4
Intel (NIC: 10Gb, FH)	1,2,7,8	4
Intel (NIC: 1Gb, FH)	1,2,7,8	4
Broadcom (NIC: 1Gb, FH)	1,2,7,8	4
Intel (OCP: 25Gb)	Integrated slot	1
Mellanox (OCP: 25Gb)	Integrated slot	1
Broadcom (OCP: 25Gb)	Integrated slot	1
Broadcom (OCP: 10Gb)	Integrated slot	1
Intel (OCP: 10Gb)	Integrated slot	1
Broadcom (OCP: 10Gb)	Integrated slot	1
Broadcom (OCP: 1Gb)	Integrated slot	1
Intel (OCP: 1Gb)	Integrated slot	1
FOXCONN (BOSS-N1)	Integrated slot	1

Table 110. Config2. R1B+R2A+R3B+R4B

CARD TYPE	SLOT PRIORITY	MAXIMUM NUMBER OF CARDS
Inventec (Serial, FH)	4,8	1
NVIDIA (GPU A2, FH)	1,2,4,5,7,8	6
FOXCONN (FPERC H965)	Integrated slot	2
FOXCONN (FPERC H755N)	Integrated slot	2
FOXCONN (FPERC H755)	Integrated slot	1
FOXCONN (FPERC H355)	Integrated slot	1
FOXCONN (FPERC HBA355I)	Integrated slot	1
FOXCONN (APERC H965, LP/FH)	3	1
FOXCONN (APERC H755, LP/FH)	1,2,3	1
FOXCONN (APERC H355, LP/FH)	1,2,3	1
FOXCONN (APERC HBA355I, LP/FH)	1,2,3	1
FOXCONN (External Adapter HBA355E, LP)	3,6	2
External Adapter HBA465E, LP/FH	1,2,3,4,5,6,7,8	8
External Adapter H965e, LP/FH	1,2,3,4,5,6,7,8	8
Inventec (LOM Card)	Integrated slot	1

Table 110. Config2. R1B+R2A+R3B+R4B (continued)

CARD TYPE	SLOT PRIORITY	MAXIMUM NUMBER OF CARDS
Broadcom (NIC: 100Gb, LP)	3,6	2
Intel (NIC: 100Gb, FH)	1,2,4,5,7,8	6
Intel (NIC: 100Gb, LP)	3,6	2
Mellanox (NIC: 100Gb, LP)	3	1
Intel (NIC: 25Gb, FH)	1,2,4,5,7,8	6
Intel (NIC: 25Gb, LP)	3,6	2
Mellanox (NIC: 25Gb, FH)	1,2,4,5,7,8	6
Mellanox (NIC: 25Gb, LP)	3,6	2
Broadcom (NIC: 25Gb, LP)	3,6	2
Broadcom (NIC: 25Gb, FH)	1,2,4,5,7,8	6
Broadcom (HBA: FC64, FH)	1,2,4,5,7,8	6
Broadcom (HBA: FC64, LP)	3,6	2
Broadcom (HBA: FC32, FH)	1,2,4,5,7,8	6
Broadcom (HBA: FC32, LP)	3,6	2
Marvell (HBA: FC32, FH)	1,2,4,5,7,8	6
Marvell (HBA: FC32, LP)	3,6	2
Broadcom (NIC: 10Gb, FH)	1,2,4,5,7,8	6
Broadcom (NIC: 10Gb, LP)	3,6	2
Intel (NIC: 10Gb, FH)	1,2,4,5,7,8	6
Intel (NIC: 10Gb, LP)	3,6	2
Intel (NIC: 1Gb, LP)	3,6	2
Intel (NIC: 1Gb, FH)	1,2,4,5,7,8	6
Broadcom (NIC: 1Gb, FH)	1,2,4,5,7,8	6
Broadcom (NIC: 1Gb, LP)	3,6	2
Mellanox (NIC: NDR200, LP)	3,6	2
Mellanox (NIC: HDRV, LP)	3,6	2
Intel (OCP: 25Gb)	Integrated slot	1
Mellanox (OCP: 25Gb)	Integrated slot	1
Broadcom (OCP: 25Gb)	Integrated slot	1
Broadcom (OCP: 10Gb)	Integrated slot	1
Intel (OCP: 10Gb)	Integrated slot	1
Broadcom (OCP: 1Gb)	Integrated slot	1
Intel (OCP: 1Gb)	Integrated slot	1
FOXCONN (BOSS-N1)	Integrated slot	1

Table 111. Config3. R1Q+R2A+R3B+R4Q

CARD TYPE	SLOT PRIORITY	MAXIMUM NUMBER OF CARDS
Inventec (Serial, FH)	4,8	1

Table 111. Config3. R1Q+R2A+R3B+R4Q (continued)

CARD TYPE	SLOT PRIORITY	MAXIMUM NUMBER OF CARDS
NVIDIA (GPU A2, FH)	1,2,4,5,7,8	6
FOXCONN (FPERC H965)	Integrated slot	2
FOXCONN (FPERC H755N)	Integrated slot	2
FOXCONN (FPERC H755)	Integrated slot	1
FOXCONN (FPERC H355)	Integrated slot	1
FOXCONN (FPERC HBA355I)	Integrated slot	1
FOXCONN (APERC H965, LP/FH)	3	1
FOXCONN (APERC H755, LP/FH)	1,2,3	1
FOXCONN (APERC H355, LP/FH)	1,2,3	1
FOXCONN (APERC HBA355I, LP/FH)	1,2,3	1
FOXCONN (External Adapter HBA355E, LP)	3,6	2
External Adapter HBA465E, LP/FH	1,2,3,4,5,6,7,8	8
External Adapter H965e, LP/FH	1,2,3,4,5,6,7,8	8
Inventec (LOM Card)	Integrated slot	1
Inventec (Paige Card)	Integrated slot	1
Inventec (Melody Card)	Integrated slot	1
Intel (SmartNIC: 100Gb, FH)	7	1
Mellanox (SmartNIC: 25Gb, FH)	7	1
Intel (SmartNIC: 25Gb, FH)	7	1
Mellanox (NIC: 400Gb, LP)	3,6	2
Broadcom (NIC: 100Gb, LP)	3,6	2
Intel (NIC: 100Gb, FH)	1,2,4,5,7,8	6
Intel (NIC: 100Gb, LP)	3,6	2
Mellanox (NIC: 100Gb, LP)	3	1
Intel (NIC: 25Gb, FH)	1,2,4,5,7,8	6
Intel (NIC: 25Gb, LP)	3,6	2
Mellanox (NIC: 25Gb, FH)	1,2,4,5,7,8	6
Mellanox (NIC: 25Gb, LP)	3,6	2
Broadcom (NIC: 25Gb, LP)	3,6	2
Broadcom (NIC: 25Gb, FH)	1,2,4,5,7,8	6
Broadcom (HBA: FC64, FH)	1,2,4,5,7,8	6
Broadcom (HBA: FC64, LP)	3,6	2
Broadcom (HBA: FC32, FH)	1,2,4,5,7,8	6
Broadcom (HBA: FC32, LP)	3,6	2
Marvell (HBA: FC32, FH)	1,2,4,5,7,8	6
Marvell (HBA: FC32, LP)	3,6	2
Broadcom (NIC: 10Gb, FH)	1,2,4,5,7,8	6

Table 111. Config3. R1Q+R2A+R3B+R4Q (continued)

CARD TYPE	SLOT PRIORITY	MAXIMUM NUMBER OF CARDS
Broadcom (NIC: 10Gb, LP)	3,6	2
Intel (NIC: 10Gb, FH)	1,2,4,5,7,8	6
Intel (NIC: 10Gb, LP)	3,6	2
Intel (NIC: 1Gb, LP)	3,6	2
Intel (NIC: 1Gb, FH)	1,2,4,5,7,8	6
Broadcom (NIC: 1Gb, FH)	1,2,4,5,7,8	6
Broadcom (NIC: 1Gb, LP)	3,6	2
Mellanox (NIC: NDR200, LP)	3,6	2
Mellanox (NIC: HDRV, LP)	3,6	2
Intel (OCP: 25Gb)	Integrated slot	1
Mellanox (OCP: 25Gb)	Integrated slot	1
Broadcom (OCP: 25Gb)	Integrated slot	1
Broadcom (OCP: 10Gb)	Integrated slot	1
Intel (OCP: 10Gb)	Integrated slot	1
Broadcom (OCP: 1Gb)	Integrated slot	1
Intel (OCP: 1Gb)	Integrated slot	1
FOXCONN (BOSS-N1)	Integrated slot	1

Table 112. Config4-1. R1P+R2A+R3B+R4P(HL)

CARD TYPE	SLOT PRIORITY	MAXIMUM NUMBER OF CARDS
Inventec (Serial, FH)	4	1
NVIDIA (GPU A2, FH)	2,4,5,7	4
FOXCONN (FPERC H965)	Integrated slot	2
FOXCONN (FPERC H755N)	Integrated slot	2
FOXCONN (FPERC H755)	Integrated slot	1
FOXCONN (FPERC H355)	Integrated slot	1
FOXCONN (FPERC HBA355I)	Integrated slot	1
FOXCONN (APERC H965, LP/FH)	3	1
FOXCONN (APERC H755, LP/FH)	2,3	1
FOXCONN (APERC H355, LP/FH)	2,3	1
FOXCONN (APERC HBA355I, LP/FH)	2,3	1
FOXCONN (External Adapter HBA355E, LP)	3,6	2
External Adapter HBA465E, LP/FH	2,3,4,5,6,7	6
External Adapter H965e, LP/FH	2,3,4,5,6,7	6
Inventec (LOM Card)	Integrated slot	1
Inventec (Paige Card)	Integrated slot	1
Inventec (Melody Card)	Integrated slot	1

Table 112. Config4-1. R1P+R2A+R3B+R4P(HL) (continued)

CARD TYPE	SLOT PRIORITY	MAXIMUM NUMBER OF CARDS
Pesandro (SmartNIC: 100Gb, FH)	2,7	2
Intel (SmartNIC: 100Gb, FH)	2,7	2
Mellanox (SmartNIC: 100Gb, FH)	2,7	2
Pesandro (SmartNIC: 25Gb, FH)	2,7	2
Mellanox (SmartNIC: 25Gb, FH)	2,7	2
Intel (SmartNIC: 25Gb, FH)	2,7	2
Mellanox (NIC: 400Gb, FH)	2,7	2
Mellanox (NIC: 400Gb, LP)	3,6	2
Broadcom (NIC: 100Gb, FH)	2,7	2
Broadcom (NIC: 100Gb, LP)	3,6	2
Intel (NIC: 100Gb, FH)	2,4,5,7	4
Intel (NIC: 100Gb, LP)	3,6	2
Mellanox (NIC: 100Gb, FH)	2,7	2
Mellanox (NIC: 100Gb, LP)	3	1
Intel (NIC: 25Gb, FH)	2,4,5,7	4
Intel (NIC: 25Gb, LP)	3,6	2
Mellanox (NIC: 25Gb, FH)	2,4,5,7	4
Mellanox (NIC: 25Gb, LP)	3,6	2
Broadcom (NIC: 25Gb, FH)	2,7	2
Broadcom (NIC: 25Gb, LP)	3,6	2
Broadcom (NIC: 25Gb, FH)	2,4,5,7	4
Broadcom (HBA: FC64, FH)	2,4,5,7	4
Broadcom (HBA: FC64, LP)	3,6	2
Broadcom (HBA: FC32, FH)	2,4,5,7	4
Broadcom (HBA: FC32, LP)	3,6	2
Marvell (HBA: FC32, FH)	2,4,5,7	4
Marvell (HBA: FC32, LP)	3,6	2
Broadcom (NIC: 10Gb, FH)	2,4,5,7	4
Broadcom (NIC: 10Gb, LP)	3,6	2
Intel (NIC: 10Gb, FH)	2,4,5,7	4
Intel (NIC: 10Gb, LP)	3,6	2
Intel (NIC: 1Gb, LP)	3,6	2
Intel (NIC: 1Gb, FH)	2,4,5,7	4
Broadcom (NIC: 1Gb, FH)	2,4,5,7	4
Broadcom (NIC: 1Gb, LP)	3,6	2
Mellanox (NIC: NDR200, FH)	2,7	2
Mellanox (NIC: NDR200, LP)	3,6	2

Table 112. Config4-1. R1P+R2A+R3B+R4P(HL) (continued)

CARD TYPE	SLOT PRIORITY	MAXIMUM NUMBER OF CARDS
Mellanox (NIC: HDRV, FH)	2,7	2
Mellanox (NIC: HDRV, LP)	3,6	2
Intel (OCP: 25Gb)	Integrated slot	1
Mellanox (OCP: 25Gb)	Integrated slot	1
Broadcom (OCP: 25Gb)	Integrated slot	1
Broadcom (OCP: 10Gb)	Integrated slot	1
Intel (OCP: 10Gb)	Integrated slot	1
Broadcom (OCP: 1Gb)	Integrated slot	1
Intel (OCP: 1Gb)	Integrated slot	1
FOXCONN (BOSS-N1)	Integrated slot	1

Table 113. Config4-2. R1P+R2A+R3B+R4P(FL)

CARD TYPE	SLOT PRIORITY	MAXIMUM NUMBER OF CARDS
Inventec (Serial, FH)	4	1
NVIDIA (GPU A40, FH)	2,7	2
NVIDIA (GPU A100, FH)	2,7	2
NVIDIA (GPU A800, FH)	2,7	2
NVIDIA (GPU A30, FH)	2,7	2
NVIDIA (GPU A16, FH)	2,7	2
AMD (GPU MI210, FH)	2,7	2
NVIDIA (GPU A2, FH)	2,4,5,7	4
FOXCONN (FPERC H965)	Integrated slot	2
FOXCONN (FPERC H755N)	Integrated slot	2
FOXCONN (FPERC H755)	Integrated slot	1
FOXCONN (FPERC H355)	Integrated slot	1
FOXCONN (FPERC HBA355I)	Integrated slot	1
FOXCONN (APERC H965, LP/FH)	3	1
FOXCONN (APERC H755, LP/FH)	2,3	1
FOXCONN (APERC H355, LP/FH)	2,3	1
FOXCONN (APERC HBA355I, LP/FH)	2,3	1
FOXCONN (External Adapter HBA355E, LP)	3,6	2
External Adapter HBA465E, LP/FH	2,3,4,5,6,7	6
External Adapter H965e, LP/FH	2,3,4,5,6,7	6
Inventec (LOM Card)	Integrated slot	1
Inventec (Paige Card)	Integrated slot	1
Inventec (Melody Card)	Integrated slot	1
Pesandro (SmartNIC: 100Gb, FH)	2,7	2

Table 113. Config4-2. R1P+R2A+R3B+R4P(FL) (continued)

CARD TYPE	SLOT PRIORITY	MAXIMUM NUMBER OF CARDS
Intel (SmartNIC: 100Gb, FH)	2,7	2
Mellanox (SmartNIC: 100Gb, FH)	2,7	2
Pesandro (SmartNIC: 25Gb, FH)	2,7	2
Mellanox (SmartNIC: 25Gb, FH)	2,7	2
Intel (SmartNIC: 25Gb, FH)	2,7	2
Mellanox (NIC: 400Gb, FH)	2,7	2
Mellanox (NIC: 400Gb, LP)	3,6	2
Broadcom (NIC: 100Gb, FH)	2,7	2
Broadcom (NIC: 100Gb, LP)	3,6	2
Intel (NIC: 100Gb, FH)	2,4,5,7	4
Intel (NIC: 100Gb, LP)	3,6	2
Mellanox (NIC: 100Gb, FH)	2,7	2
Mellanox (NIC: 100Gb, LP)	3	1
Intel (NIC: 25Gb, FH)	2,4,5,7	4
Intel (NIC: 25Gb, LP)	3,6	2
Mellanox (NIC: 25Gb, FH)	2,4,5,7	4
Mellanox (NIC: 25Gb, LP)	3,6	2
Broadcom (NIC: 25Gb, FH)	2,7	2
Broadcom (NIC: 25Gb, LP)	3,6	2
Broadcom (NIC: 25Gb, FH)	2,4,5,7	4
Broadcom (HBA: FC64, FH)	2,4,5,7	4
Broadcom (HBA: FC64, LP)	3,6	2
Broadcom (HBA: FC32, FH)	2,4,5,7	4
Broadcom (HBA: FC32, LP)	3,6	2
Marvell (HBA: FC32, FH)	2,4,5,7	4
Marvell (HBA: FC32, LP)	3,6	2
Broadcom (NIC: 10Gb, FH)	2,4,5,7	4
Broadcom (NIC: 10Gb, LP)	3,6	2
Intel (NIC: 10Gb, FH)	2,4,5,7	4
Intel (NIC: 1Gb, LP)	3,6	2
Intel (NIC: 1Gb, FH)	2,4,5,7	4
Broadcom (NIC: 1Gb, FH)	2,4,5,7	4
Broadcom (NIC: 1Gb, LP)	3,6	2
Mellanox (NIC: NDR200, FH)	2,7	2
Mellanox (NIC: NDR200, LP)	3,6	2
Mellanox (NIC: HDRV, FH)	2,7	2
Mellanox (NIC: HDRV, LP)	3,6	2

Table 113. Config4-2. R1P+R2A+R3B+R4P(FL) (continued)

CARD TYPE	SLOT PRIORITY	MAXIMUM NUMBER OF CARDS
Intel (OCP: 25Gb)	Integrated slot	1
Mellanox (OCP: 25Gb)	Integrated slot	1
Broadcom (OCP: 25Gb)	Integrated slot	1
Broadcom (OCP: 10Gb)	Integrated slot	1
Intel (OCP: 10Gb)	Integrated slot	1
Broadcom (OCP: 1Gb)	Integrated slot	1
Intel (OCP: 1Gb)	Integrated slot	1
FOXCONN (BOSS-N1)	Integrated slot	1

Table 114. Config5-1. R1S+R2A+R3A+R4P(HL)

CARD TYPE	SLOT PRIORITY	MAXIMUM NUMBER OF CARDS
NVIDIA (GPU A2, FH)	1,2,5,7	4
FOXCONN (FPERC H965)	Integrated slot	2
FOXCONN (FPERC H755N)	Integrated slot	2
FOXCONN (FPERC H755)	Integrated slot	1
FOXCONN (FPERC H355)	Integrated slot	1
FOXCONN (FPERC HBA355I)	Integrated slot	1
FOXCONN (External Adapter HBA355E, LP)	3,6	2
External Adapter HBA465E, LP/FH	1,2,3,5,6,7	6
External Adapter H965e, LP/FH	1,2,3,5,6,7	6
Inventec (LOM Card)	Integrated slot	1
Inventec (Paige Card)	Integrated slot	1
Inventec (Melody Card)	Integrated slot	1
Pesandro (SmartNIC: 100Gb, FH)	2,7	2
Intel (SmartNIC: 100Gb, FH)	2,7	2
Mellanox (SmartNIC: 100Gb, FH)	2,7	2
Pesandro (SmartNIC: 25Gb, FH)	2,7	2
Mellanox (SmartNIC: 25Gb, FH)	2,7	2
Intel (SmartNIC: 25Gb, FH)	2,7	2
Mellanox (NIC: 400Gb, FH)	1,2,5,7	4
Mellanox (NIC: 400Gb, LP)	3,6	2
Broadcom (NIC: 100Gb, FH)	1,2,5,7	4
Broadcom (NIC: 100Gb, LP)	3,6	2
Intel (NIC: 100Gb, FH)	1,2,5,7	4
Intel (NIC: 100Gb, LP)	3,6	2
Mellanox (NIC: 100Gb, FH)	1,2,5,7	4
Mellanox (NIC: 100Gb, LP)	3	1

Table 114. Config5-1. R1S+R2A+R3A+R4P(HL) (continued)

CARD TYPE	SLOT PRIORITY	MAXIMUM NUMBER OF CARDS
Intel (NIC: 25Gb, FH)	1,2,5,7	4
Intel (NIC: 25Gb, LP)	3,6	2
Mellanox (NIC: 25Gb, FH)	1,2,5,7	4
Mellanox (NIC: 25Gb, LP)	3,6	2
Broadcom (NIC: 25Gb, FH)	1,2,5,7	4
Broadcom (NIC: 25Gb, LP)	3,6	2
Broadcom (HBA: FC64, FH)	1,2,5,7	4
Broadcom (HBA: FC64, LP)	3,6	2
Broadcom (HBA: FC32, FH)	1,2,5,7	4
Broadcom (HBA: FC32, LP)	3,6	2
Marvell (HBA: FC32, FH)	1,2,5,7	4
Marvell (HBA: FC32, LP)	3,6	2
Broadcom (NIC: 10Gb, FH)	1,2,5,7	4
Broadcom (NIC: 10Gb, LP)	3,6	2
Intel (NIC: 10Gb, FH)	1,2,5,7	4
Intel (NIC: 1Gb, LP)	3,6	2
Intel (NIC: 1Gb, FH)	1,2,5,7	4
Broadcom (NIC: 1Gb, FH)	1,2,5,7	4
Broadcom (NIC: 1Gb, LP)	3,6	2
Mellanox (NIC: NDR200, FH)	1,2,5,7	4
Mellanox (NIC: NDR200, LP)	3,6	2
Mellanox (NIC: HDRV, FH)	1,2,5,7	4
Mellanox (NIC: HDRV, LP)	3,6	2
Intel (OCP: 25Gb)	Integrated slot	1
Mellanox (OCP: 25Gb)	Integrated slot	1
Broadcom (OCP: 25Gb)	Integrated slot	1
Broadcom (OCP: 10Gb)	Integrated slot	1
Intel (OCP: 10Gb)	Integrated slot	1
Broadcom (OCP: 1Gb)	Integrated slot	1
Intel (OCP: 1Gb)	Integrated slot	1
FOXCONN (BOSS-N1)	Integrated slot	1

Table 115. Config5-2. R1S+R2A+R3A+R4P(FL)

CARD TYPE	SLOT PRIORITY	MAXIMUM NUMBER OF CARDS
NVIDIA (GPU A40, FH)	7	1
NVIDIA (GPU A100, FH)	7	1
NVIDIA (GPU A800, FH)	7	1
NVIDIA (GPU A30, FH)	7	1

Table 115. Config5-2. R1S+R2A+R3A+R4P(FL) (continued)

CARD TYPE	SLOT PRIORITY	MAXIMUM NUMBER OF CARDS
NVIDIA (GPU A16, FH)	7	1
AMD (GPU MI210, FH)	7	1
NVIDIA (GPU A2, FH)	1,2,5,7	4
FOXCONN (FPERC H965)	Integrated slot	2
FOXCONN (FPERC H755N)	Integrated slot	2
FOXCONN (FPERC H755)	Integrated slot	1
FOXCONN (FPERC H355)	Integrated slot	1
FOXCONN (FPERC HBA355I)	Integrated slot	1
FOXCONN (External Adapter HBA355E, LP)	3,6	2
External Adapter HBA465E, LP/FH	1,2,3,5,6,7	6
External Adapter H965e, LP/FH	1,2,3,5,6,7	6
Inventec (LOM Card)	Integrated slot	1
Inventec (Paige Card)	Integrated slot	1
Inventec (Melody Card)	Integrated slot	1
Pesandro (SmartNIC: 100Gb, FH)	2,7	2
Intel (SmartNIC: 100Gb, FH)	2,7	2
Mellanox (SmartNIC: 100Gb, FH)	2,7	2
Pesandro (SmartNIC: 25Gb, FH)	2,7	2
Mellanox (SmartNIC: 25Gb, FH)	2,7	2
Intel (SmartNIC: 25Gb, FH)	2,7	2
Mellanox (NIC: 400Gb, FH)	1,2,5,7	4
Mellanox (NIC: 400Gb, LP)	3,6	2
Broadcom (NIC: 100Gb, FH)	1,2,5,7	4
Broadcom (NIC: 100Gb, LP)	3,6	2
Intel (NIC: 100Gb, FH)	1,2,5,7	4
Intel (NIC: 100Gb, LP)	3,6	2
Mellanox (NIC: 100Gb, FH)	1,2,5,7	4
Mellanox (NIC: 100Gb, LP)	3	1
Intel (NIC: 25Gb, FH)	1,2,5,7	4
Intel (NIC: 25Gb, LP)	3,6	2
Mellanox (NIC: 25Gb, FH)	1,2,5,7	4
Mellanox (NIC: 25Gb, LP)	3,6	2
Broadcom (NIC: 25Gb, FH)	1,2,5,7	4
Broadcom (NIC: 25Gb, LP)	3,6	2
Broadcom (HBA: FC64, FH)	1,2,5,7	4
Broadcom (HBA: FC64, LP)	3,6	2
Broadcom (HBA: FC32, FH)	1,2,5,7	4

Table 115. Config5-2. R1S+R2A+R3A+R4P(FL) (continued)

CARD TYPE	SLOT PRIORITY	MAXIMUM NUMBER OF CARDS
Broadcom (HBA: FC32, LP)	3,6	2
Marvell (HBA: FC32, FH)	1,2,5,7	4
Marvell (HBA: FC32, LP)	3,6	2
Broadcom (NIC: 10Gb, FH)	1,2,5,7	4
Broadcom (NIC: 10Gb, LP)	3,6	2
Intel (NIC: 10Gb, FH)	1,2,5,7	4
Intel (NIC: 1Gb, LP)	3,6	2
Intel (NIC: 1Gb, FH)	1,2,5,7	4
Broadcom (NIC: 1Gb, FH)	1,2,5,7	4
Broadcom (NIC: 1Gb, LP)	3,6	2
Mellanox (NIC: NDR200, FH)	1,2,5,7	4
Mellanox (NIC: NDR200, LP)	3,6	2
Mellanox (NIC: HDRV, FH)	1,2,5,7	4
Mellanox (NIC: HDRV, LP)	3,6	2
Intel (OCP: 25Gb)	Integrated slot	1
Mellanox (OCP: 25Gb)	Integrated slot	1
Broadcom (OCP: 25Gb)	Integrated slot	1
Broadcom (OCP: 10Gb)	Integrated slot	1
Intel (OCP: 10Gb)	Integrated slot	1
Broadcom (OCP: 1Gb)	Integrated slot	1
Intel (OCP: 1Gb)	Integrated slot	1
FOXCONN (BOSS-N1)	Integrated slot	1

Table 116. Config6. R2A+R4Q

CARD TYPE	SLOT PRIORITY	MAXIMUM NUMBER OF CARDS
Inventec (Serial, FH)	8	1
NVIDIA (GPU A2, FH)	7,8	2
FOXCONN (FPERC H965)	Integrated slot	2
FOXCONN (FPERC H755)	Integrated slot	1
FOXCONN (FPERC H355)	Integrated slot	1
FOXCONN (FPERC HBA355I)	Integrated slot	1
FOXCONN (APERC H965, LP)	3	1
FOXCONN (APERC H755, LP)	2,3	1
FOXCONN (APERC H355, LP)	2,3	1
FOXCONN (APERC HBA355I, LP)	2,3	1
FOXCONN (External Adapter HBA355E, LP)	3,6	2
External Adapter HBA465E, LP/FH	3,6,7,8	4

Table 116. Config6. R2A+R4Q (continued)

CARD TYPE	SLOT PRIORITY	MAXIMUM NUMBER OF CARDS
External Adapter H965e, LP/FH	3,6,7,8	4
Inventec (LOM Card)	Integrated slot	1
Inventec (Paige Card)	Integrated slot	1
Inventec (Melody Card)	Integrated slot	1
Intel (SmartNIC: 100Gb, FH)	7	1
Mellanox (SmartNIC: 25Gb, FH)	7	1
Intel (SmartNIC: 25Gb, FH)	7	1
Mellanox (NIC: 400Gb, LP)	3,6	2
Broadcom (NIC: 100Gb, LP)	3,6	2
Intel (NIC: 100Gb, FH)	7,8	2
Intel (NIC: 100Gb, LP)	3,6	2
Mellanox (NIC: 100Gb, LP)	3	1
Intel (NIC: 25Gb, FH)	7,8	2
Intel (NIC: 25Gb, LP)	3,6	2
Mellanox (NIC: 25Gb, FH)	7,8	2
Mellanox (NIC: 25Gb, LP)	3,6	2
Broadcom (NIC: 25Gb, LP)	3,6	2
Broadcom (NIC: 25Gb, FH)	7,8	2
Broadcom (HBA: FC64, FH)	7,8	2
Broadcom (HBA: FC64, LP)	3,6	2
Broadcom (HBA: FC32, FH)	7,8	2
Broadcom (HBA: FC32, LP)	3,6	2
Marvell (HBA: FC32, FH)	7,8	2
Marvell (HBA: FC32, LP)	3,6	2
Broadcom (NIC: 10Gb, FH)	7,8	2
Broadcom (NIC: 10Gb, LP)	3,6	2
Intel (NIC: 10Gb, FH)	7,8	2
Intel (NIC: 10Gb, LP)	3,6	2
Intel (NIC: 1Gb, LP)	3,6	2
Intel (NIC: 1Gb, FH)	7,8	2
Broadcom (NIC: 1Gb, FH)	7,8	2
Broadcom (NIC: 1Gb, LP)	3,6	2
Mellanox (NIC: NDR200, LP)	3,6	2
Mellanox (NIC: HDRV, LP)	3,6	2
Intel (OCP: 25Gb)	Integrated slot	1
Mellanox (OCP: 25Gb)	Integrated slot	1
Broadcom (OCP: 25Gb)	Integrated slot	1

Table 116. Config6. R2A+R4Q (continued)

CARD TYPE	SLOT PRIORITY	MAXIMUM NUMBER OF CARDS
Broadcom (OCP: 10Gb)	Integrated slot	1
Intel (OCP: 10Gb)	Integrated slot	1
Broadcom (OCP: 1Gb)	Integrated slot	1
Intel (OCP: 1Gb)	Integrated slot	1
FOXCONN (BOSS-N1)	Integrated slot	1

Table 117. Config7. R1Q+R2A+R4Q

CARD TYPE	SLOT PRIORITY	MAXIMUM NUMBER OF CARDS
Inventec (Serial, FH)	8	1
NVIDIA (GPU A2, FH)	1,2,7,8	4
FOXCONN (FPERC H965)	Integrated slot	1
FOXCONN (FPERC H755)	Integrated slot	1
FOXCONN (FPERC H355)	Integrated slot	1
FOXCONN (FPERC HBA355I)	Integrated slot	1
FOXCONN (APERC H965, LP)	3	1
FOXCONN (APERC H755, LP/FH)	1,2,3	1
FOXCONN (APERC H355, LP/FH)	1,2,3	1
FOXCONN (APERC HBA355I, LP/FH)	1,2,3	1
FOXCONN (External Adapter HBA355E, LP)	3,6	2
External Adapter HBA465E, LP/FH	1,2,3,6,7,8	6
External Adapter H965e, LP/FH	1,2,3,6,7,8	6
Inventec (LOM Card)	Integrated slot	1
Inventec (Paige Card)	Integrated slot	1
Inventec (Melody Card)	Integrated slot	1
Intel (SmartNIC: 100Gb, FH)	7	1
Mellanox (SmartNIC: 25Gb, FH)	7	1
Intel (SmartNIC: 25Gb, FH)	7	1
Mellanox (NIC: 400Gb, LP)	3,6	2
Broadcom (NIC: 100Gb, LP)	3,6	2
Intel (NIC: 100Gb, FH)	1,2,7,8	4
Intel (NIC: 100Gb, LP)	3,6	2
Mellanox (NIC: 100Gb, LP)	3	1
Intel (NIC: 25Gb, FH)	1,2,7,8	4
Intel (NIC: 25Gb, LP)	3,6	2
Mellanox (NIC: 25Gb, FH)	1,2,7,8	4
Mellanox (NIC: 25Gb, LP)	3,6	2
Broadcom (NIC: 25Gb, LP)	3,6	2

Table 117. Config7. R1Q+R2A+R4Q (continued)

CARD TYPE	SLOT PRIORITY	MAXIMUM NUMBER OF CARDS
Broadcom (NIC: 25Gb, FH)	1,2,7,8	4
Broadcom (HBA: FC64, FH)	1,2,7,8	4
Broadcom (HBA: FC64, LP)	3,6	2
Broadcom (HBA: FC32, FH)	1,2,7,8	4
Broadcom (HBA: FC32, LP)	3,6	2
Marvell (HBA: FC32, FH)	1,2,7,8	4
Marvell (HBA: FC32, LP)	3,6	2
Broadcom (NIC: 10Gb, FH)	1,2,7,8	4
Broadcom (NIC: 10Gb, LP)	3,6	2
Intel (NIC: 10Gb, FH)	1,2,7,8	4
Intel (NIC: 10Gb, LP)	3,6	2
Intel (NIC: 1Gb, LP)	3,6	2
Intel (NIC: 1Gb, FH)	1,2,7,8	4
Broadcom (NIC: 1Gb, FH)	1,2,7,8	4
Broadcom (NIC: 1Gb, LP)	3,6	2
Mellanox (NIC: NDR200, LP)	3,6	2
Mellanox (NIC: HDRV, LP)	3,6	2
Intel (OCP: 25Gb)	Integrated slot	1
Mellanox (OCP: 25Gb)	Integrated slot	1
Broadcom (OCP: 25Gb)	Integrated slot	1
Broadcom (OCP: 10Gb)	Integrated slot	1
Intel (OCP: 10Gb)	Integrated slot	1
Broadcom (OCP: 1Gb)	Integrated slot	1
Intel (OCP: 1Gb)	Integrated slot	1
FOXCONN (BOSS-N1)	Integrated slot	1

Table 118. Config8. R2A+R3B+R1_R4 Paddle

CARD TYPE	SLOT PRIORITY	MAXIMUM NUMBER OF CARDS
Inventec (Serial, FH)	4	1
NVIDIA (GPU A2, FH)	4,5	2
FOXCONN (External Adapter HBA355E, LP)	3,6	2
External Adapter HBA465E, LP/FH	3,4,5,6	4
External Adapter H965e, LP/FH	3,4,5,6	4
Inventec (LOM Card)	Integrated slot	1
Mellanox (NIC: 400Gb, LP)	3,6	2
Broadcom (NIC: 100Gb, LP)	3,6	2
Intel (NIC: 100Gb, FH)	4,5	2

Table 118. Config8. R2A+R3B+R1_R4 Paddle (continued)

CARD TYPE	SLOT PRIORITY	MAXIMUM NUMBER OF CARDS
Intel (NIC: 100Gb, LP)	3,6	2
Mellanox (NIC: 100Gb, LP)	3	1
Intel (NIC: 25Gb, FH)	4,5	2
Intel (NIC: 25Gb, LP)	3,6	2
Mellanox (NIC: 25Gb, FH)	4,5	2
Mellanox (NIC: 25Gb, LP)	3,6	2
Broadcom (NIC: 25Gb, LP)	3,6	2
Broadcom (NIC: 25Gb, FH)	4,5	2
Broadcom (HBA: FC64, FH)	4,5	2
Broadcom (HBA: FC64, LP)	3,6	2
Broadcom (HBA: FC32, FH)	4,5	2
Broadcom (HBA: FC32, LP)	3,6	2
Marvell (HBA: FC32, FH)	4,5	2
Marvell (HBA: FC32, LP)	3,6	2
Broadcom (NIC: 10Gb, FH)	4,5	2
Broadcom (NIC: 10Gb, LP)	3,6	2
Intel (NIC: 10Gb, FH)	4,5	2
Intel (NIC: 10Gb, LP)	3,6	2
Intel (NIC: 1Gb, LP)	3,6	2
Intel (NIC: 1Gb, FH)	4,5	2
Broadcom (NIC: 1Gb, FH)	4,5	2
Broadcom (NIC: 1Gb, LP)	3,6	2
Mellanox (NIC: NDR200, LP)	3,6	2
Mellanox (NIC: HDRV, LP)	3,6	2
Intel (OCP: 25Gb)	Integrated slot	1
Mellanox (OCP: 25Gb)	Integrated slot	1
Broadcom (OCP: 25Gb)	Integrated slot	1
Broadcom (OCP: 10Gb)	Integrated slot	1
Intel (OCP: 10Gb)	Integrated slot	1
Broadcom (OCP: 1Gb)	Integrated slot	1
Intel (OCP: 1Gb)	Integrated slot	1
FOXCONN (BOSS-N1)	Integrated slot	1

Table 119. Config9. R1B+R2A (1CPU Min Con)

CARD TYPE	SLOT PRIORITY	MAXIMUM NUMBER OF CARDS
NVIDIA (GPU A2, FH)	1,2	2
FOXCONN (APERC H355, LP/FH)	1,2,3	1

Table 119. Config9. R1B+R2A (1CPU Min Con) (continued)

CARD TYPE	SLOT PRIORITY	MAXIMUM NUMBER OF CARDS
FOXCONN (External Adapter HBA355E, LP)	3	1
External Adapter HBA465E, LP/FH	1,2,3	3
External Adapter H965e, LP/FH	1,2,3	3
Inventec (LOM Card)	Integrated slot	1
Mellanox (NIC: 400Gb, LP)	3	1
Broadcom (NIC: 100Gb, LP)	3	1
Intel (NIC: 100Gb, FH)	1,2	2
Intel (NIC: 100Gb, LP)	3	1
Mellanox (NIC: 100Gb, LP)	3	1
Intel (NIC: 25Gb, FH)	1,2	2
Intel (NIC: 25Gb, LP)	3	1
Mellanox (NIC: 25Gb, FH)	1,2	2
Mellanox (NIC: 25Gb, LP)	3	1
Broadcom (NIC: 25Gb, LP)	3	1
Broadcom (NIC: 25Gb, FH)	1,2	2
Broadcom (HBA: FC64, FH)	1,2	2
Broadcom (HBA: FC64, LP)	3	1
Broadcom (HBA: FC32, FH)	1,2	2
Broadcom (HBA: FC32, LP)	3	1
Marvell (HBA: FC32, FH)	1,2	2
Marvell (HBA: FC32, LP)	3	1
Broadcom (NIC: 10Gb, FH)	1,2	2
Broadcom (NIC: 10Gb, LP)	3	1
Intel (NIC: 10Gb, FH)	1,2	2
Intel (NIC: 10Gb, LP)	3	1
Intel (NIC: 1Gb, LP)	3	1
Intel (NIC: 1Gb, FH)	1,2	2
Broadcom (NIC: 1Gb, FH)	1,2	2
Broadcom (NIC: 1Gb, LP)	3	1
Mellanox (NIC: NDR200, LP)	3	1
Mellanox (NIC: HDRV, LP)	3	1
Intel (OCP: 25Gb)	Integrated slot	1
Mellanox (OCP: 25Gb)	Integrated slot	1
Broadcom (OCP: 25Gb)	Integrated slot	1
Broadcom (OCP: 10Gb)	Integrated slot	1
Intel (OCP: 10Gb)	Integrated slot	1
Broadcom (OCP: 1Gb)	Integrated slot	1

Table 119. Config9. R1B+R2A (1CPU Min Con) (continued)

CARD TYPE	SLOT PRIORITY	MAXIMUM NUMBER OF CARDS
Intel (OCP: 1Gb)	Integrated slot	1
FOXCONN (BOSS-N1)	Integrated slot	1

Table 120. Config10. R2A+R3B

CARD TYPE	SLOT PRIORITY	MAXIMUM NUMBER OF CARDS
Inventec (Serial, FH)	4	1
NVIDIA (GPU A2, FH)	4,5	2
FOXCONN (FPERC H965)	Integrated slot	1
FOXCONN (FPERC H755)	Integrated slot	1
FOXCONN (FPERC H355)	Integrated slot	1
FOXCONN (FPERC HBA355I)	Integrated slot	1
FOXCONN (APERC H755, LP/FH)	3	1
FOXCONN (APERC H355, LP/FH)	3	1
FOXCONN (APERC HBA355I, LP/FH)	3	1
FOXCONN (External Adapter HBA355E, LP)	3,6	2
External Adapter HBA465E, LP/FH	3,4,5,6	4
External Adapter H965e, LP/FH	3,4,5,6	4
Inventec (LOM Card)	Integrated slot	1
Mellanox (NIC: 400Gb, LP)	3,6	2
Broadcom (NIC: 100Gb, LP)	3,6	2
Intel (NIC: 100Gb, FH)	4,5	2
Intel (NIC: 100Gb, LP)	3,6	2
Mellanox (NIC: 100Gb, LP)	3	1
Intel (NIC: 25Gb, FH)	4,5	2
Intel (NIC: 25Gb, LP)	3,6	2
Mellanox (NIC: 25Gb, FH)	4,5	2
Mellanox (NIC: 25Gb, LP)	3,6	2
Broadcom (NIC: 25Gb, LP)	3,6	2
Broadcom (NIC: 25Gb, FH)	4,5	2
Broadcom (HBA: FC64, FH)	4,5	2
Broadcom (HBA: FC64, LP)	3,6	2
Broadcom (HBA: FC32, FH)	4,5	2
Broadcom (HBA: FC32, LP)	3,6	2
Marvell (HBA: FC32, FH)	4,5	2
Marvell (HBA: FC32, LP)	3,6	2
Broadcom (NIC: 10Gb, FH)	4,5	2
Broadcom (NIC: 10Gb, LP)	3,6	2

Table 120. Config10. R2A+R3B (continued)

CARD TYPE	SLOT PRIORITY	MAXIMUM NUMBER OF CARDS
Intel (NIC: 10Gb, FH)	4,5	2
Intel (NIC: 10Gb, LP)	3,6	2
Intel (NIC: 1Gb, LP)	3,6	2
Intel (NIC: 1Gb, FH)	4,5	2
Broadcom (NIC: 1Gb, FH)	4,5	2
Broadcom (NIC: 1Gb, LP)	3,6	2
Mellanox (NIC: NDR200, LP)	3,6	2
Mellanox (NIC: HDRV, LP)	3,6	2
Intel (OCP: 25Gb)	Integrated slot	1
Mellanox (OCP: 25Gb)	Integrated slot	1
Broadcom (OCP: 25Gb)	Integrated slot	1
Broadcom (OCP: 10Gb)	Integrated slot	1
Intel (OCP: 10Gb)	Integrated slot	1
Broadcom (OCP: 1Gb)	Integrated slot	1
Intel (OCP: 1Gb)	Integrated slot	1
FOXCONN (BOSS-N1)	Integrated slot	1

Table 121. Config11. R2A+R3B+E3 R1_R4 Paddle

CARD TYPE	SLOT PRIORITY	MAXIMUM NUMBER OF CARDS
Inventec (Serial, FH)	4	1
NVIDIA (GPU A2, FH)	4,5	2
FOXCONN (External Adapter HBA355E, LP)	3,6	2
External Adapter HBA465E, LP/FH	3,4,5,6	4
External Adapter H965e, LP/FH	3,4,5,6	4
Inventec (LOM Card)	Integrated slot	1
Mellanox (NIC: 400Gb, LP)	3,6	2
Broadcom (NIC: 100Gb, LP)	3,6	2
Intel (NIC: 100Gb, FH)	4,5	2
Intel (NIC: 100Gb, LP)	3,6	2
Mellanox (NIC: 100Gb, LP)	3	1
Intel (NIC: 25Gb, FH)	4,5	2
Intel (NIC: 25Gb, LP)	3,6	2
Mellanox (NIC: 25Gb, FH)	4,5	2
Mellanox (NIC: 25Gb, LP)	3,6	2
Broadcom (NIC: 25Gb, LP)	3,6	2
Broadcom (NIC: 25Gb, FH)	4,5	2
Broadcom (HBA: FC64, FH)	4,5	2

Table 121. Config11. R2A+R3B+E3 R1_R4 Paddle (continued)

CARD TYPE	SLOT PRIORITY	MAXIMUM NUMBER OF CARDS
Broadcom (HBA: FC64, LP)	3,6	2
Broadcom (HBA: FC32, FH)	4,5	2
Broadcom (HBA: FC32, LP)	3,6	2
Marvell (HBA: FC32, FH)	4,5	2
Marvell (HBA: FC32, LP)	3,6	2
Broadcom (NIC: 10Gb, FH)	4,5	2
Broadcom (NIC: 10Gb, LP)	3,6	2
Intel (NIC: 10Gb, FH)	4,5	2
Intel (NIC: 10Gb, LP)	3,6	2
Intel (NIC: 1Gb, LP)	3,6	2
Intel (NIC: 1Gb, FH)	4,5	2
Broadcom (NIC: 1Gb, FH)	4,5	2
Broadcom (NIC: 1Gb, LP)	3,6	2
Mellanox (NIC: NDR200, LP)	3,6	2
Mellanox (NIC: HDRV, LP)	3,6	2
Intel (OCP: 25Gb)	Integrated slot	1
Mellanox (OCP: 25Gb)	Integrated slot	1
Broadcom (OCP: 25Gb)	Integrated slot	1
Broadcom (OCP: 10Gb)	Integrated slot	1
Intel (OCP: 10Gb)	Integrated slot	1
Broadcom (OCP: 1Gb)	Integrated slot	1
Intel (OCP: 1Gb)	Integrated slot	1
FOXCONN (BOSS-N1)	Integrated slot	1

Table 122. Config12. R2A+R3B+E3 G5x4 Paddle

CARD TYPE	SLOT PRIORITY	MAXIMUM NUMBER OF CARDS
Inventec (Serial, FH)	4	1
NVIDIA (GPU A2, FH)	4,5	2
FOXCONN (External Adapter HBA355E, LP)	3,6	2
External Adapter HBA465E, LP/FH	3,4,5,6	4
External Adapter H965e, LP/FH	3,4,5,6	4
Inventec (LOM Card)	Integrated slot	1
Mellanox (NIC: 400Gb, LP)	3,6	2
Broadcom (NIC: 100Gb, LP)	3,6	2
Intel (NIC: 100Gb, FH)	4,5	2
Intel (NIC: 100Gb, LP)	3,6	2
Mellanox (NIC: 100Gb, LP)	3	1

Table 122. Config12. R2A+R3B+E3 G5x4 Paddle (continued)

CARD TYPE	SLOT PRIORITY	MAXIMUM NUMBER OF CARDS
Intel (NIC: 25Gb, FH)	4,5	2
Intel (NIC: 25Gb, LP)	3,6	2
Mellanox (NIC: 25Gb, FH)	4,5	2
Mellanox (NIC: 25Gb, LP)	3,6	2
Broadcom (NIC: 25Gb, LP)	3,6	2
Broadcom (NIC: 25Gb, FH)	4,5	2
Broadcom (HBA: FC64, FH)	4,5	2
Broadcom (HBA: FC64, LP)	3,6	2
Broadcom (HBA: FC32, FH)	4,5	2
Broadcom (HBA: FC32, LP)	3,6	2
Marvell (HBA: FC32, FH)	4,5	2
Marvell (HBA: FC32, LP)	3,6	2
Broadcom (NIC: 10Gb, FH)	4,5	2
Broadcom (NIC: 10Gb, LP)	3,6	2
Intel (NIC: 10Gb, FH)	4,5	2
Intel (NIC: 10Gb, LP)	3,6	2
Intel (NIC: 1Gb, LP)	3,6	2
Intel (NIC: 1Gb, FH)	4,5	2
Broadcom (NIC: 1Gb, FH)	4,5	2
Broadcom (NIC: 1Gb, LP)	3,6	2
Mellanox (NIC: NDR200, LP)	3,6	2
Mellanox (NIC: HDRV, LP)	3,6	2
Intel (OCP: 25Gb)	Integrated slot	1
Mellanox (OCP: 25Gb)	Integrated slot	1
Broadcom (OCP: 25Gb)	Integrated slot	1
Broadcom (OCP: 10Gb)	Integrated slot	1
Intel (OCP: 10Gb)	Integrated slot	1
Broadcom (OCP: 1Gb)	Integrated slot	1
Intel (OCP: 1Gb)	Integrated slot	1
FOXCONN (BOSS-N1)	Integrated slot	1

Table 123. Config13. R2A+R3B+E3_SCM Paddle

CARD TYPE	SLOT PRIORITY	MAXIMUM NUMBER OF CARDS
Inventec (Serial, FH)	4	1
NVIDIA (GPU A2, FH)	4,5	2
FOXCONN (External Adapter HBA355E, LP)	3,6	2
External Adapter HBA465E, LP/FH	3,4,5,6	4

Table 123. Config13. R2A+R3B+E3_SCM Paddle (continued)

CARD TYPE	SLOT PRIORITY	MAXIMUM NUMBER OF CARDS
External Adapter H965e, LP/FH	3,4,5,6	4
Inventec (LOM Card)	Integrated slot	1
Mellanox (NIC: 400Gb, LP)	3,6	2
Broadcom (NIC: 100Gb, LP)	3,6	2
Intel (NIC: 100Gb, FH)	4,5	2
Intel (NIC: 100Gb, LP)	3,6	2
Mellanox (NIC: 100Gb, LP)	3	1
Intel (NIC: 25Gb, FH)	4,5	2
Intel (NIC: 25Gb, LP)	3,6	2
Mellanox (NIC: 25Gb, FH)	4,5	2
Mellanox (NIC: 25Gb, LP)	3,6	2
Broadcom (NIC: 25Gb, LP)	3,6	2
Broadcom (NIC: 25Gb, FH)	4,5	2
Broadcom (HBA: FC64, FH)	4,5	2
Broadcom (HBA: FC64, LP)	3,6	2
Broadcom (HBA: FC32, FH)	4,5	2
Broadcom (HBA: FC32, LP)	3,6	2
Marvell (HBA: FC32, FH)	4,5	2
Marvell (HBA: FC32, LP)	3,6	2
Broadcom (NIC: 10Gb, FH)	4,5	2
Broadcom (NIC: 10Gb, LP)	3,6	2
Intel (NIC: 10Gb, FH)	4,5	2
Intel (NIC: 10Gb, LP)	3,6	2
Intel (NIC: 1Gb, LP)	3,6	2
Intel (NIC: 1Gb, FH)	4,5	2
Broadcom (NIC: 1Gb, FH)	4,5	2
Broadcom (NIC: 1Gb, LP)	3,6	2
Mellanox (NIC: NDR200, LP)	3,6	2
Mellanox (NIC: HDRV, LP)	3,6	2
Intel (OCP: 25Gb)	Integrated slot	1
Mellanox (OCP: 25Gb)	Integrated slot	1
Broadcom (OCP: 25Gb)	Integrated slot	1
Broadcom (OCP: 10Gb)	Integrated slot	1
Intel (OCP: 10Gb)	Integrated slot	1
Broadcom (OCP: 1Gb)	Integrated slot	1
Intel (OCP: 1Gb)	Integrated slot	1
FOXCONN (BOSS-N1)	Integrated slot	1

Removing the expansion card risers

Prerequisites

1. Follow the safety guidelines listed in the [Safety instructions](#).
2. Follow the procedure listed in the [Before working inside your system](#).
3. **NOTE:** If BOSS N1 module is installed, ensure to disconnect the BOSS N1 power cable and Signal cable before removing the Riser 1 cage.

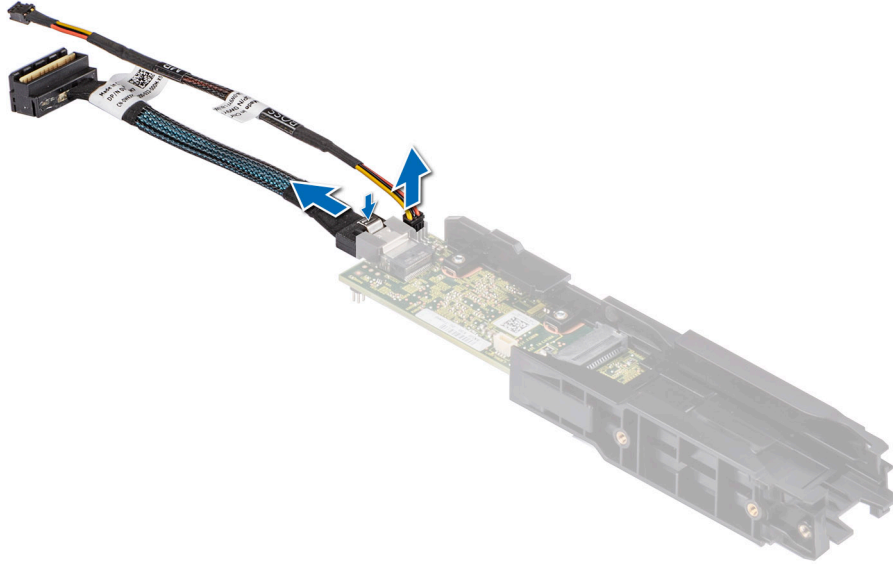

Figure 139. Removing the BOSS power cable and BOSS signal cable from the BOSS N1 controller card module

4. Disconnect any cables that are connected to the expansion card.

Steps

1. For Riser 1, loosen the captive screws on the riser.
 - a. Press the blue release tab and holding the edges lift the expansion card riser from the riser connector on the system board.
- NOTE:** The numbers on the image do not depict the exact steps. The numbers are for representation of sequence.

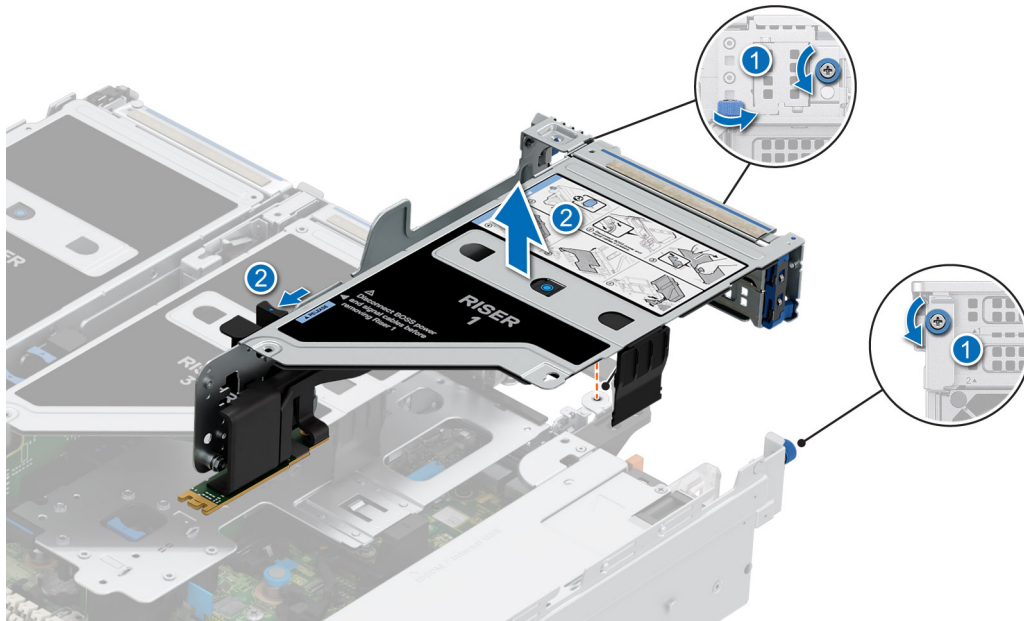

Figure 140. Removing the expansion card riser (Riser 1)

2. For Riser 3, loosen the captive screw, and then press the blue release tab and holding the edges lift the expansion card riser from the riser connector on the system board.

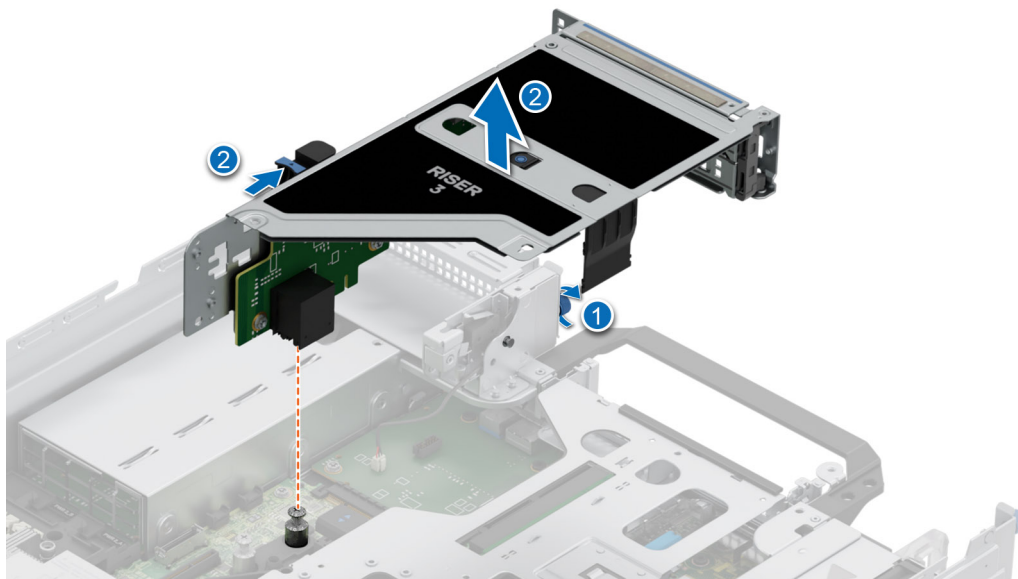

Figure 141. Removing the expansion card riser (Riser 3)

3. For Riser 2, press the blue button on the riser and holding the touch points (two strips on one side; one strip on the other side) lift the expansion card riser from the riser connector on the system board.

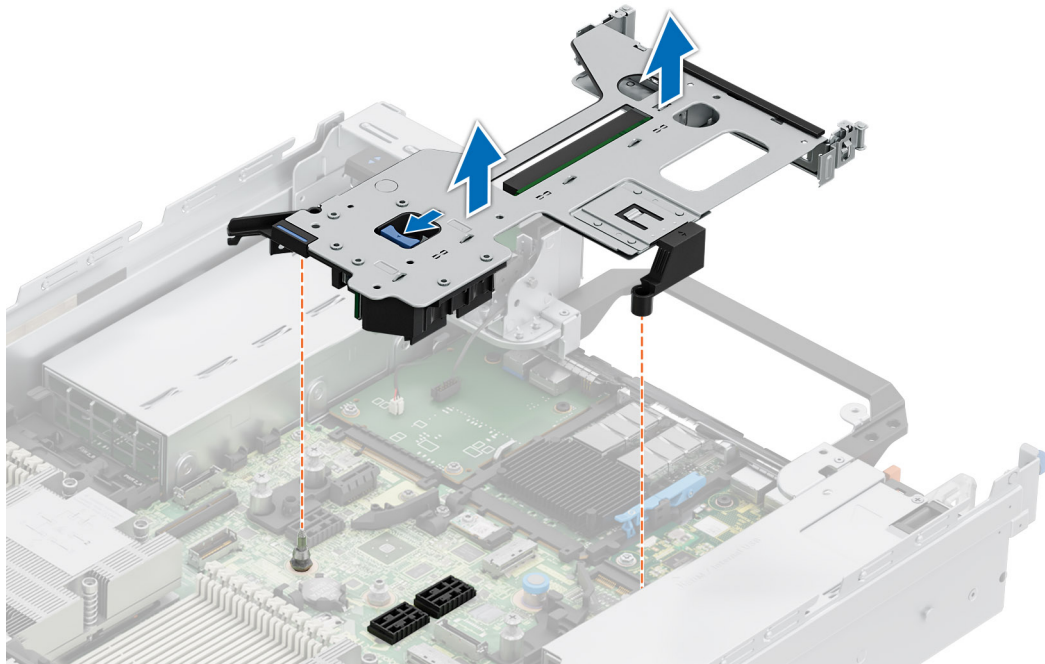

Figure 142. Removing the expansion card riser (Riser 2)

4. For Riser 4, loosen the captive screw on the riser, and then press the blue release tab on the riser, and holding the touch point lift the expansion card riser from the riser connector on the system board.

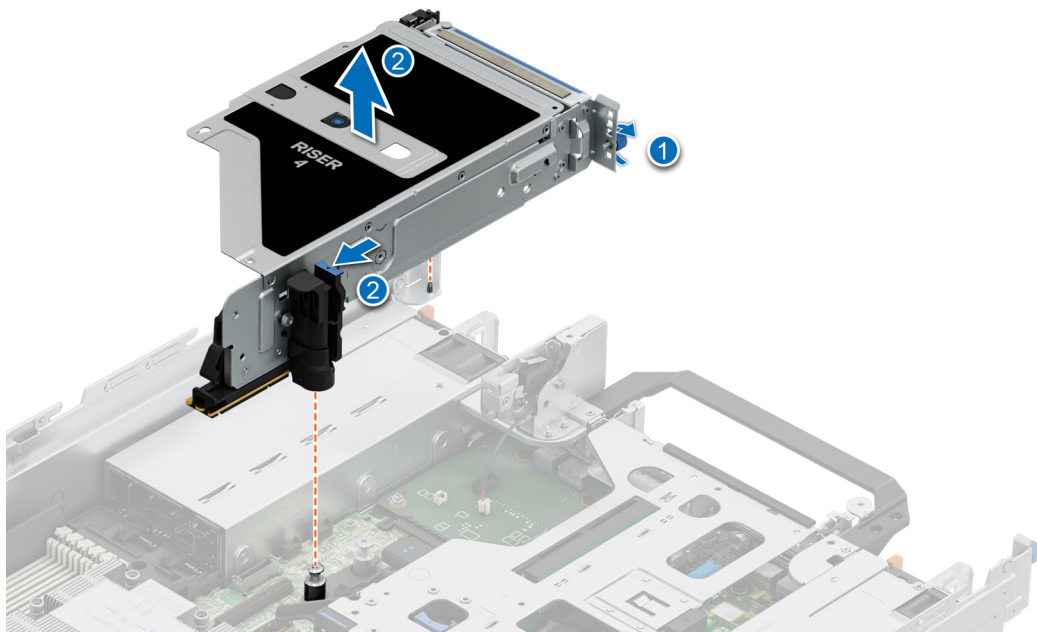

Figure 143. Removing the expansion card riser (Riser 4)

Next steps

1. [Replace the expansion card riser.](#)

Installing the expansion card risers

Prerequisites

1. Follow the safety guidelines listed in the [Safety instructions](#).
2. Follow the procedure listed in [Before working inside your system](#).
3. If removed, [install the expansion cards into the expansion card risers](#).

Steps

1. Holding the edges or the touch points, align the holes on the expansion card riser with the guides on the system board.
2. Lower the expansion card riser into place and press the touch points until the expansion card riser connector is fully seated on the system board connector.
3. Tighten the captive screws on the risers and system if any.

NOTE: The numbers on the image do not depict the exact steps. The numbers are for representation of sequence.

NOTE: Riser 2A is installed first as it is seated underneath Riser 1P and Riser 3B.

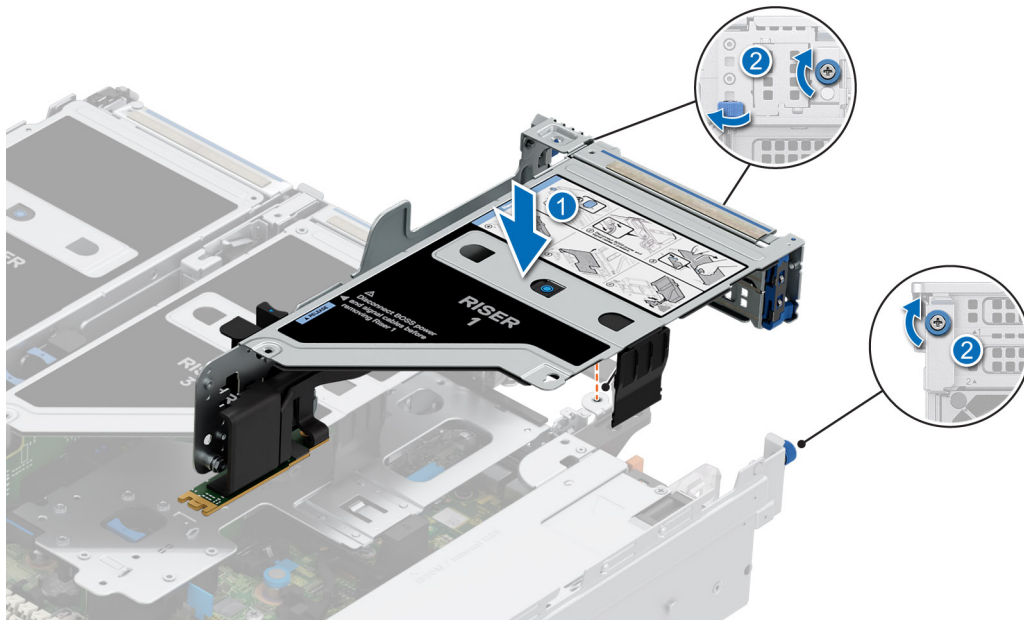

Figure 144. Installing the expansion card riser (Riser 1)

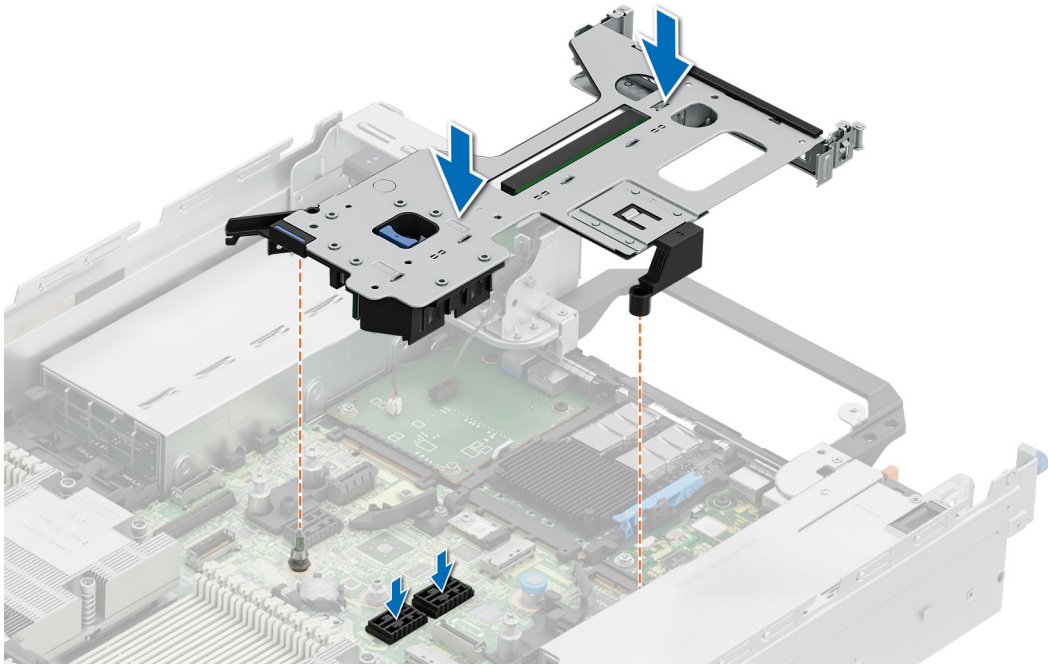

Figure 145. Installing the expansion card riser (Riser 2)

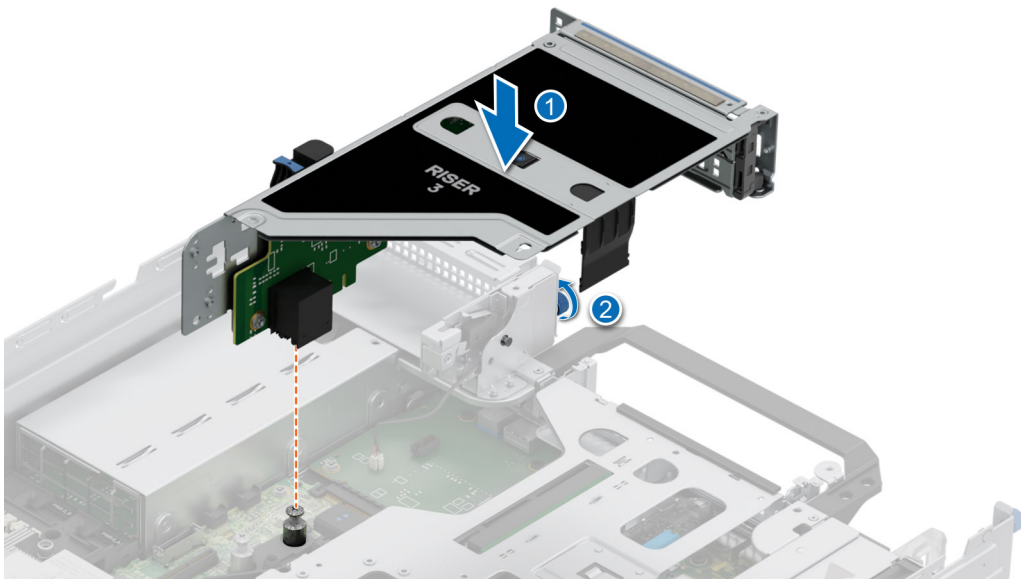

Figure 146. Installing the expansion card riser (Riser 3)

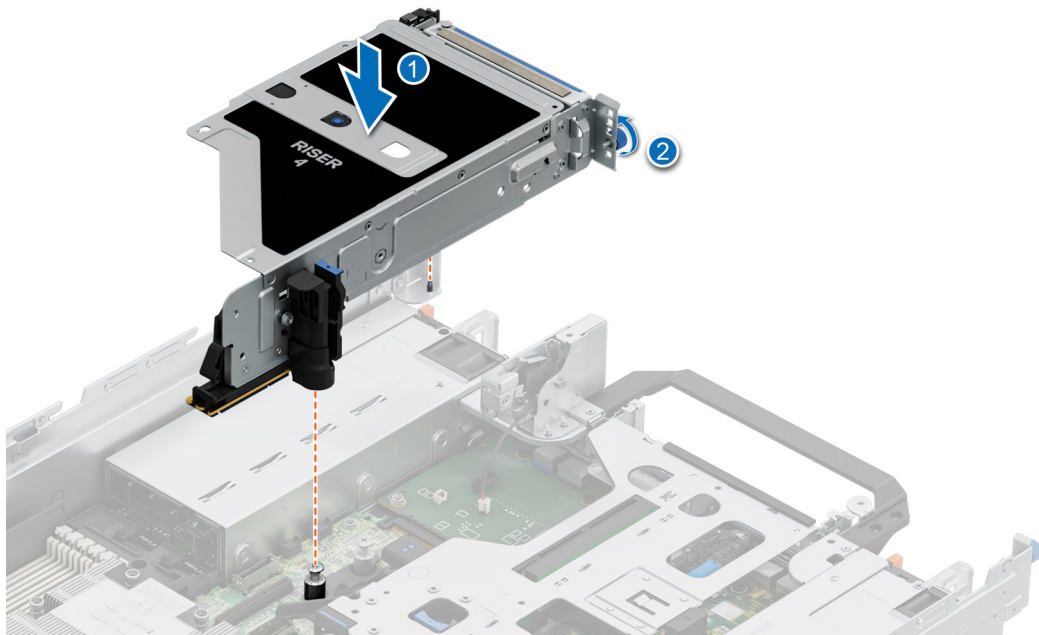

Figure 147. Installing the expansion card riser (Riser 4)

Next steps

1. If required, re-connect the cables to the expansion card.
2. Follow the procedure listed in [After working inside your system](#).
3. Install any device drivers required for the card as described in the documentation for the card.

Removing expansion card from the expansion card riser

Prerequisites

1. Follow the safety guidelines listed in the [Safety instructions](#).
2. Follow the procedure listed in the [Before working inside your system](#).
3. If applicable, disconnect the cables from the expansion card.
4. [Remove the expansion card riser](#).

Steps

1. Pull and lift the expansion card retention latch lock to open.
2. Pull the black card holder before removing the card from the riser.
3. Hold the expansion card by the edges, and pull the card until the card edge connector disengages from the expansion card connector on the riser.

NOTE: The numbers on the image do not depict the exact steps. The numbers are for representation of sequence.

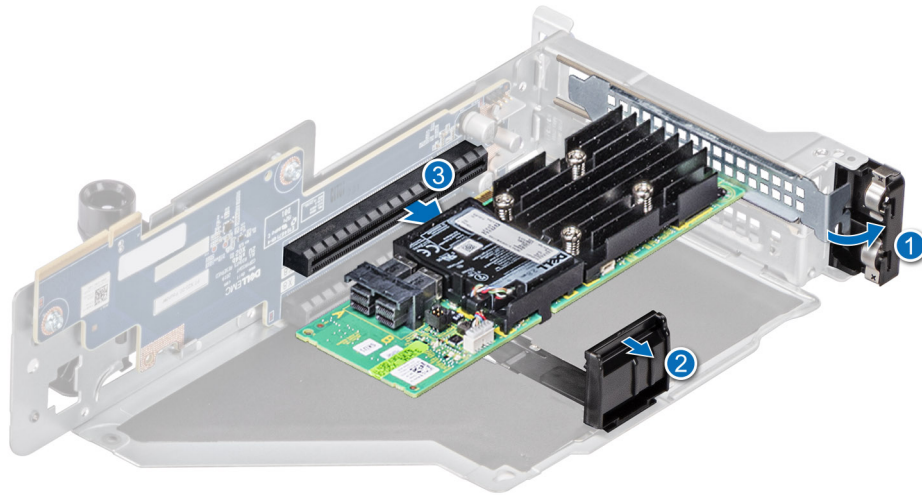

Figure 148. Removing expansion card from the expansion card riser

4. If the expansion card is not going to be replaced, install a filler bracket and close the card retention latch.

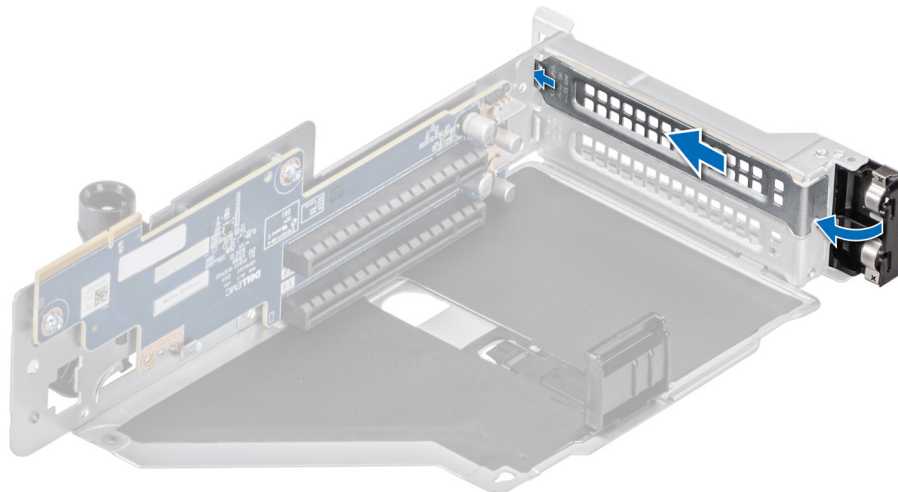

Figure 149. Installing the filler bracket

Next steps

1. If applicable, [install an expansion card into the expansion card riser](#).

Installing an expansion card into the expansion card riser

Prerequisites

1. Follow the safety guidelines listed in the [Safety instructions](#).
2. Follow the procedure listed in [Before working inside your system](#).
3. If installing a new expansion card, unpack it and prepare the card for installation.

NOTE: For instructions, see the documentation accompanying the card.

Steps

1. Pull and lift up the expansion card retention latch lock to open.

2. If installed, remove the filler bracket.

NOTE: Store the filler bracket for future use. Filler brackets must be installed in empty expansion card slots to maintain Federal Communications Commission (FCC) certification of the system. The brackets also keep dust and dirt out of the system and aid in proper cooling and airflow inside the system.

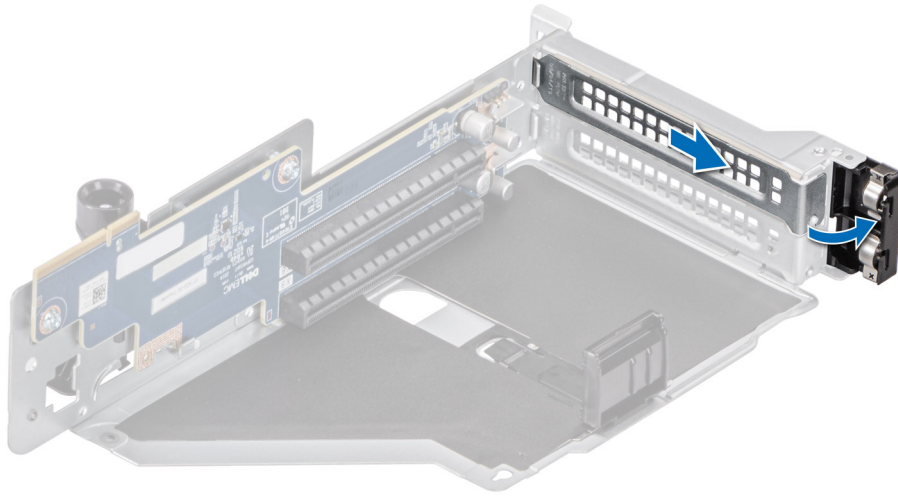

Figure 150. Removing the filler bracket

3. Hold the card by its edges, and align the card edge connector with the expansion card connector on the riser.
4. Insert the card edge connector firmly into the expansion card connector until the card is fully seated.
5. Close the expansion card retention latch.
6. Push the black card holder to hold the card in the riser.

NOTE: The numbers on the image do not depict the exact steps. The numbers are for representation of sequence.

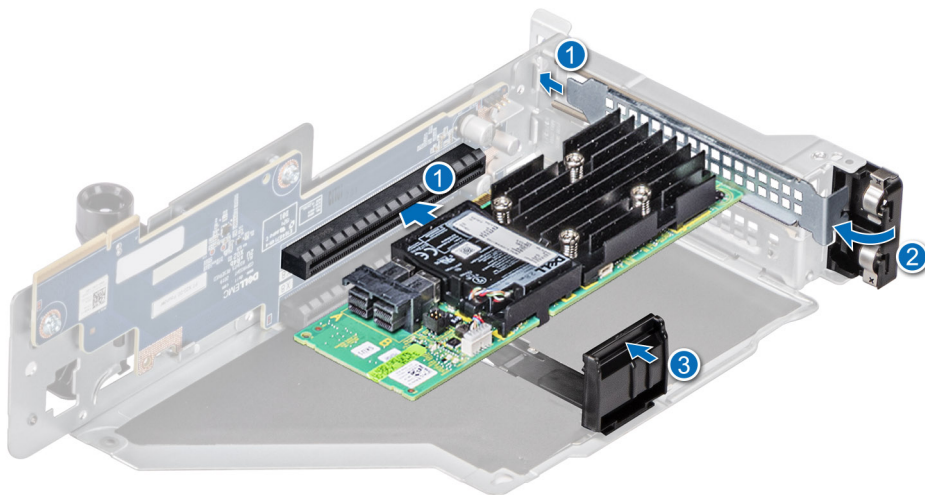



Figure 151. Installing an expansion card into the expansion card riser

Next steps

1. If applicable, connect the cables to the expansion card.
2. Follow the procedure listed in [After working inside your system](#).
3. Install any device drivers required for the card as described in the documentation for the card.

Removing the full length expansion card risers

Prerequisites

1. Follow the safety guidelines listed in the [Safety instructions](#).
2. Follow the procedure listed in the [Before working inside your system](#).
3. [Remove the GPU air shroud top cover](#).
4. If applicable, disconnect the cables from the expansion card or system board.
5.  **NOTE:** If BOSS-N1 module is installed, ensure to disconnect the BOSS-N1 power cable and Signal cable before removing the Riser 1 cage.

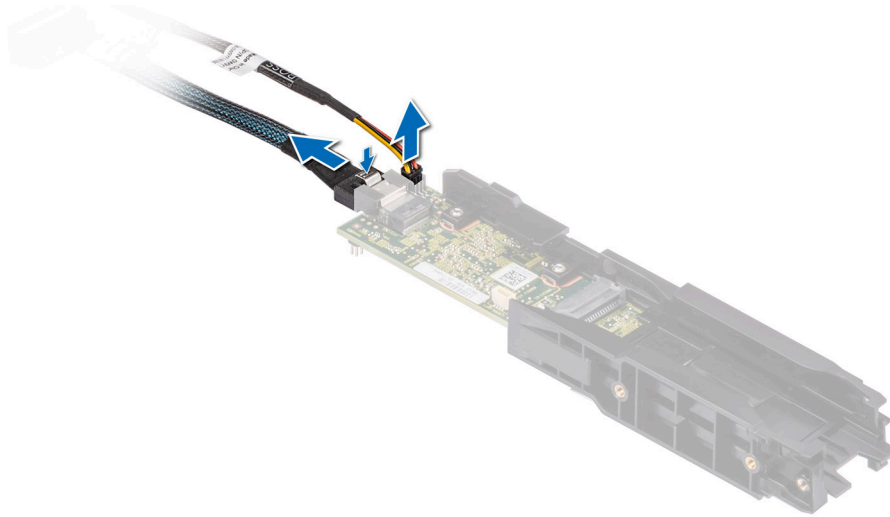

Steps

1. To remove full length expansion card riser:
 - a. Loosen the captive screws on the riser.
 - b. Press the blue release tab and holding the edges, lift the expansion card riser from the riser connector on the system board.
 - c. Disconnect the GPU power cable and signal cable from the system board. **NOTE:** The numbers on the image do not depict the exact steps. The numbers are for representation of sequence.

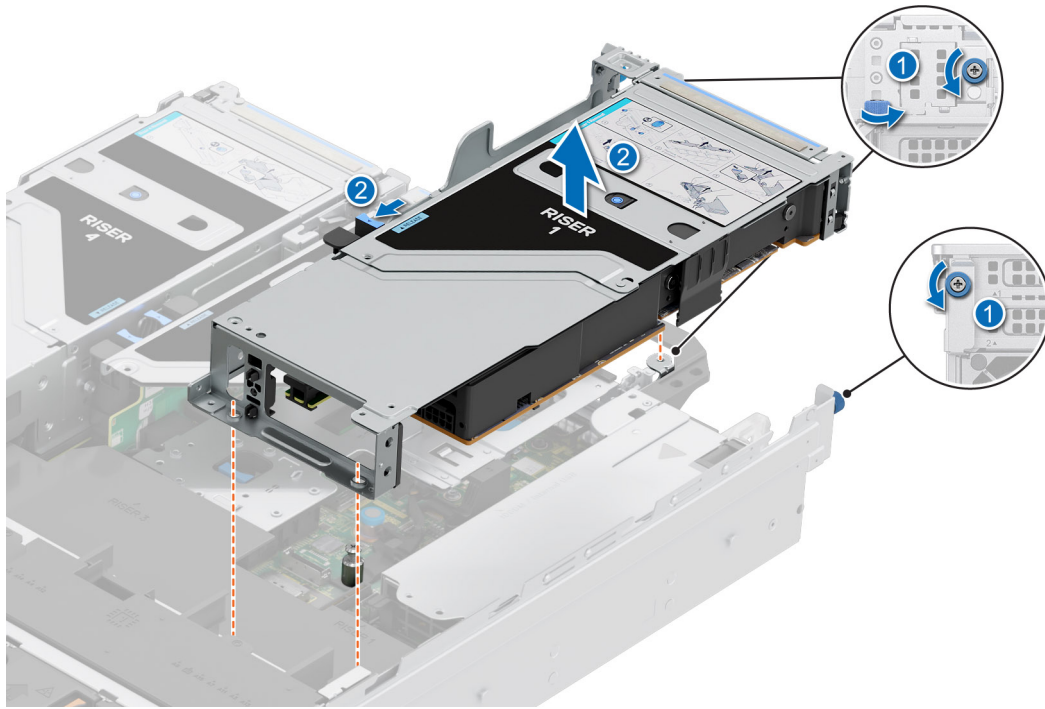

Figure 152. Removing the expansion card riser (Riser 1)

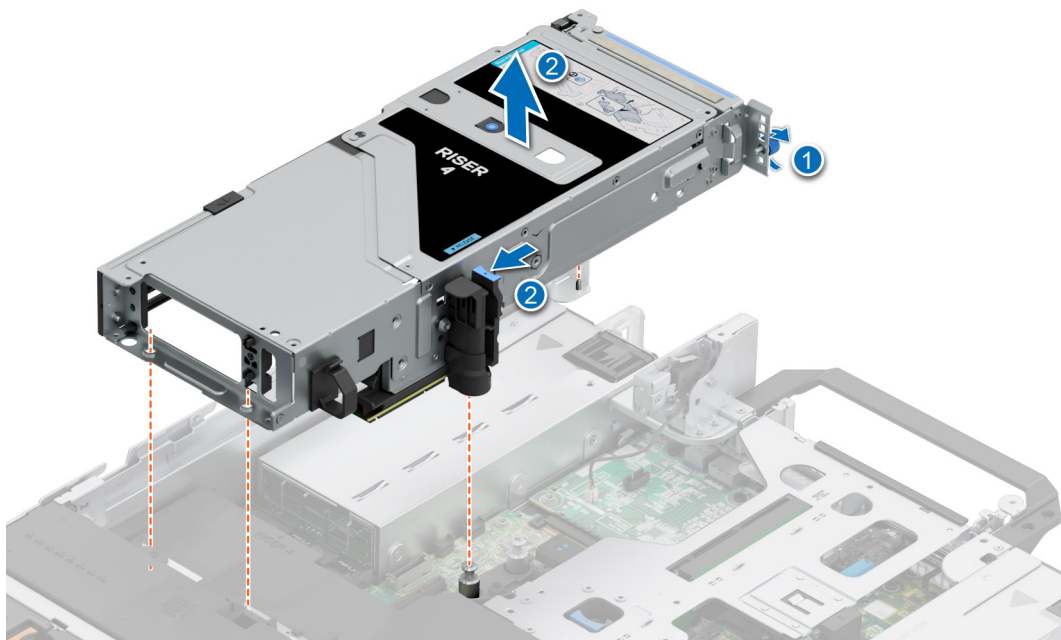

Figure 153. Removing the expansion card riser (Riser 4)

2. If the risers are not going to be replaced, install riser blanks and tighten the captive screws.

i **NOTE:** You must install a filler bracket over an empty expansion card slot to maintain Federal Communications Commission (FCC) certification of the system. The brackets also keep dust and dirt out of the system and aid in proper cooling and airflow inside the system.

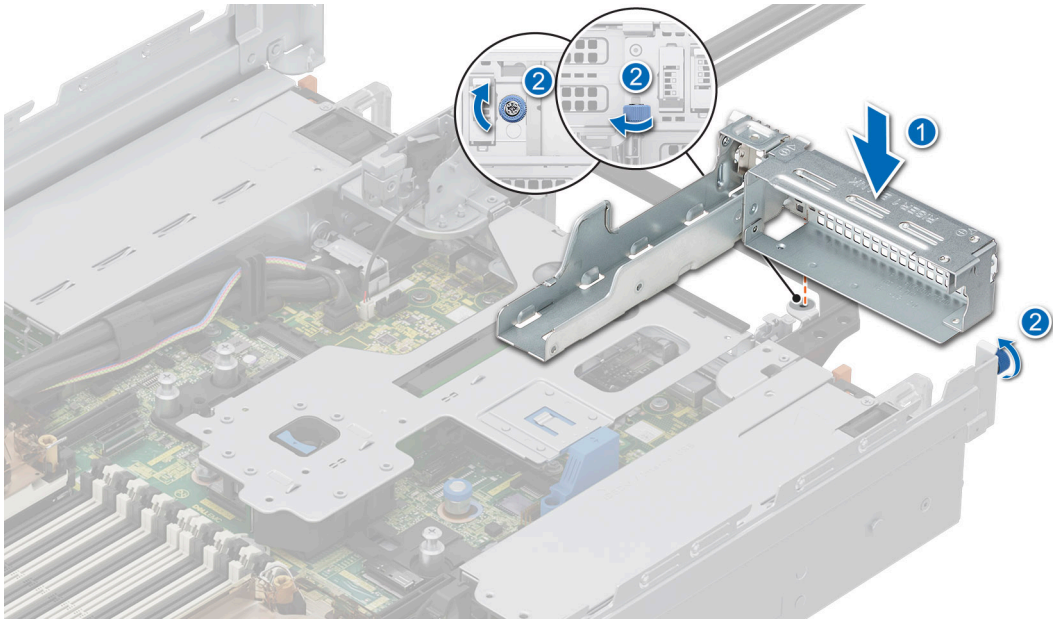

Figure 154. Installing the Riser 1 blank

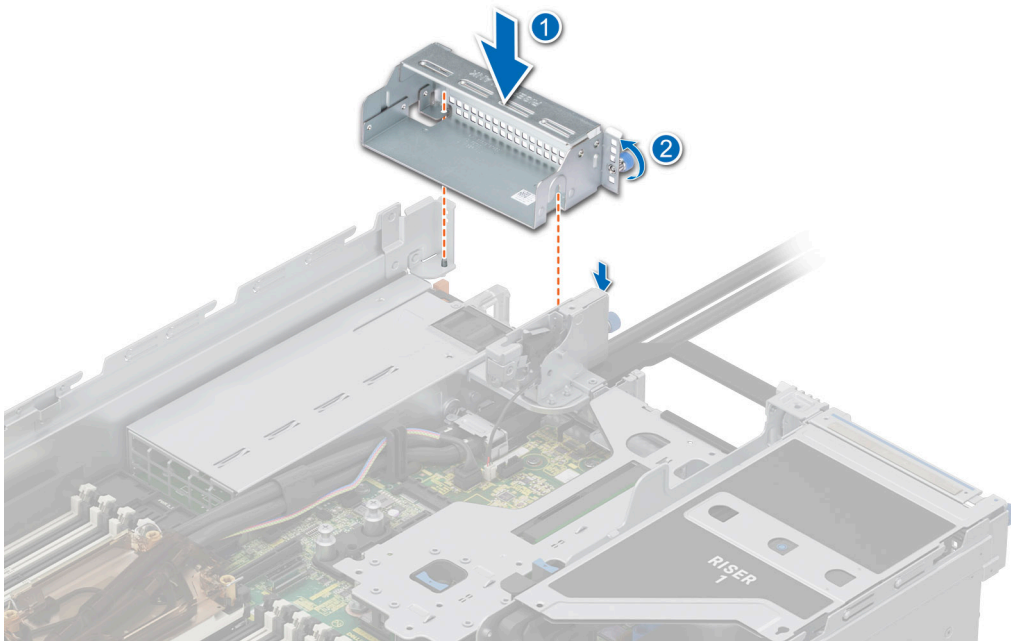

Figure 155. Installing the Riser 4 blank

Next steps

1. Replace the full length expansion card riser.

Installing the full length expansion card risers

Prerequisites

1. Follow the safety guidelines listed in the [Safety instructions](#).
2. Follow the procedure listed in [Before working inside your system](#).
3. If installing full length expansion card riser for the first time, remove [air shroud](#) and replace it with GPU air shroud.

4. Remove the GPU air shroud top cover.
5. If installed, remove the GPU air shroud filler.
6. If removed, install the GPU into the expansion card risers.

i **NOTE:** Full length risers are supported only in Riser 1 and Riser 4 slot and first install Riser4 and then Riser1.

Steps

1. If installed, remove the riser blanks by loosening the captive screws.

i **NOTE:** Store the Riser blanks for future use. Filler brackets must be installed in empty expansion card slots to maintain Federal Communications Commission (FCC) certification of the system. The brackets also keep dust and dirt out of the system and aid in proper cooling and airflow inside the system.

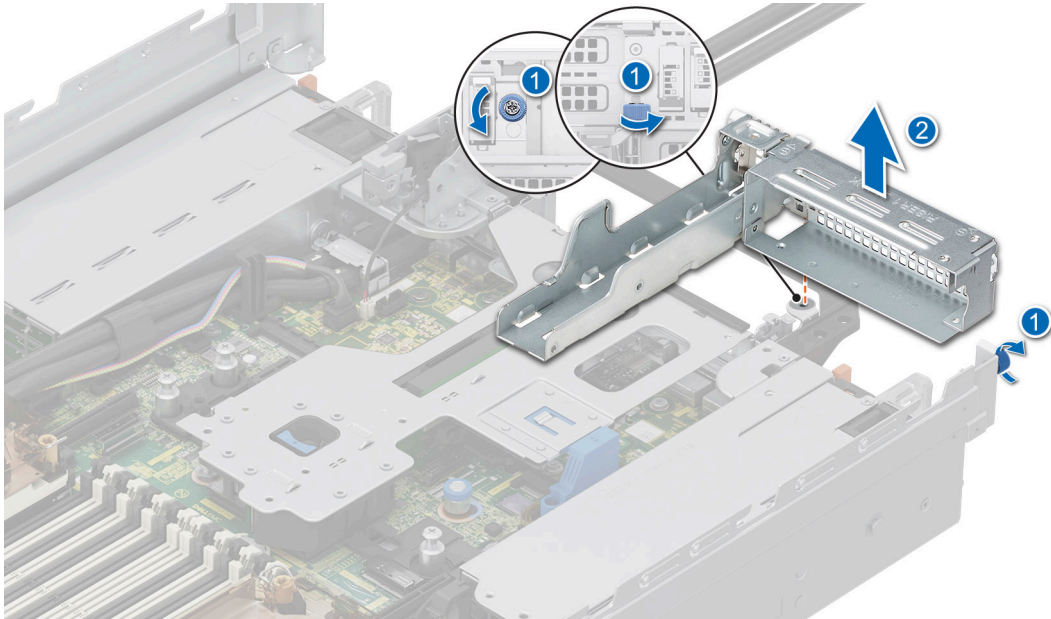

Figure 156. Removing the Riser 1 blank

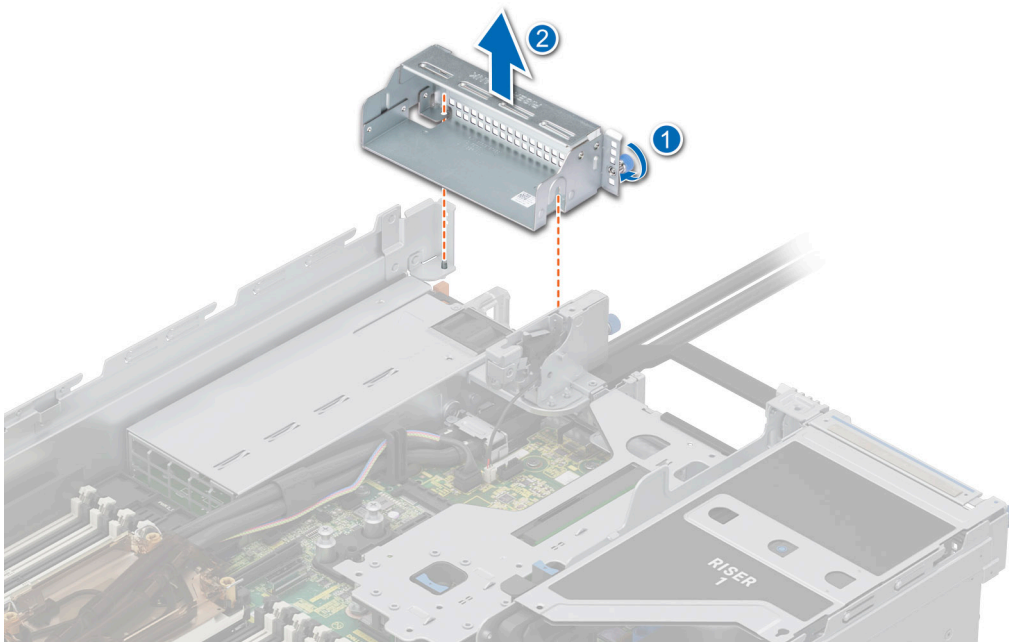

Figure 157. Removing the Riser 4 blank

2. To install the full length expansion card risers:
 - a. Connect the GPU power cable and signal cable to the connectors on the system board.
i **NOTE:** Temporarily unplug and plug the VGA cable for making space to connect Riser 1 GPU power cable to system board.
 - b. Holding the edges or the touch points, align the holes on the expansion card riser with the guides on the system board and GPU air shroud.
 - c. Lower the expansion card riser into place and press the touch points until the expansion card riser connector is fully seated on the system board connector.
 - d. Tighten the captive screws on the risers and system if any.
i **NOTE:** Route the cables properly through the riser clip.

- i** **NOTE:** The numbers on the image do not depict the exact steps. The numbers are for representation of sequence.

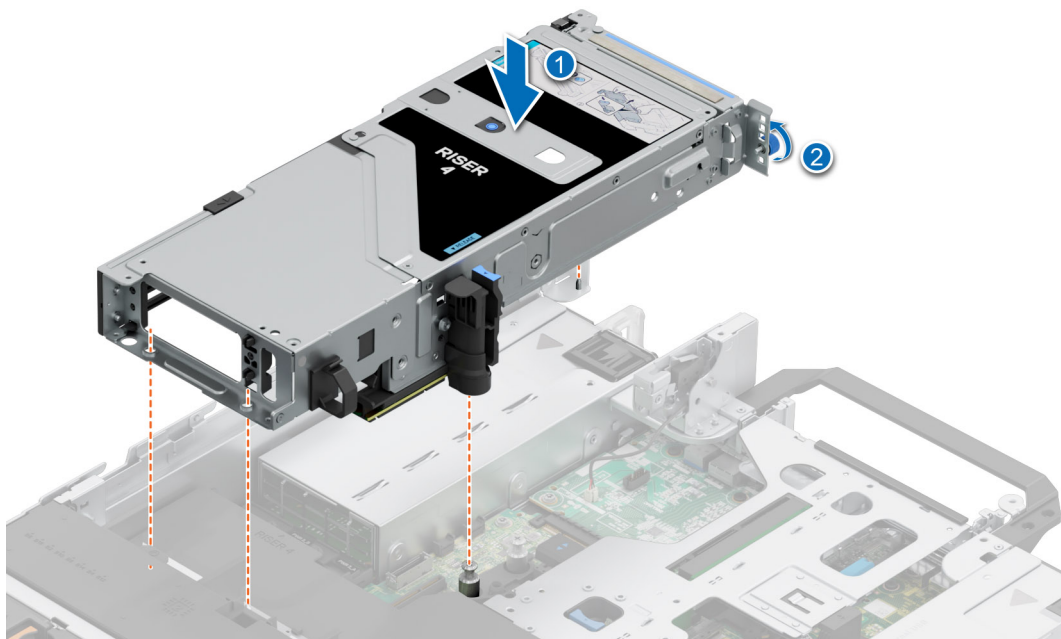

Figure 158. Installing the expansion card riser (Riser 4)

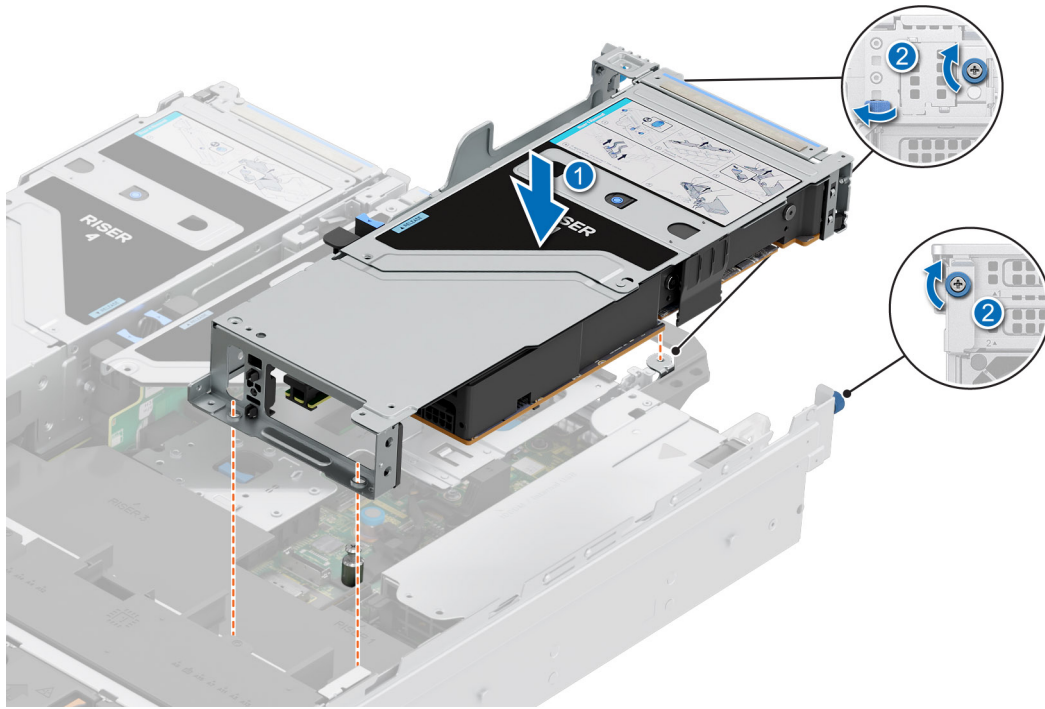

Figure 159. Installing the expansion card riser (Riser 1)

Next steps

1. If applicable, connect the cables to the expansion card or system board.
2. [Install the GPU air shroud top cover.](#)
3. Follow the procedure listed in [After working inside your system.](#)
4. Install any device drivers required for the card as described in the documentation for the card.

Removing a GPU

Prerequisites

1. Follow the safety guidelines listed in the [Safety instructions.](#)
2. Follow the procedure listed in the [Before working inside your system.](#)
3. If applicable, disconnect the cables from the expansion card.
4. [Remove the GPU air shroud top cover.](#)
5. [Remove the full length expansion card riser.](#)

Steps

1. To remove the GPU from Riser 1:
 - a. Tilt the expansion card holder latch on the riser.
 - b. Press the tab, and pull the card holder from the riser.
 - c. Hold the GPU card by the edges and pull the card from the riser.
 - d. Disconnect the GPU power cable from the GPU card.

i **NOTE:** The numbers on the image do not depict the exact steps. The numbers are for representation of sequence.

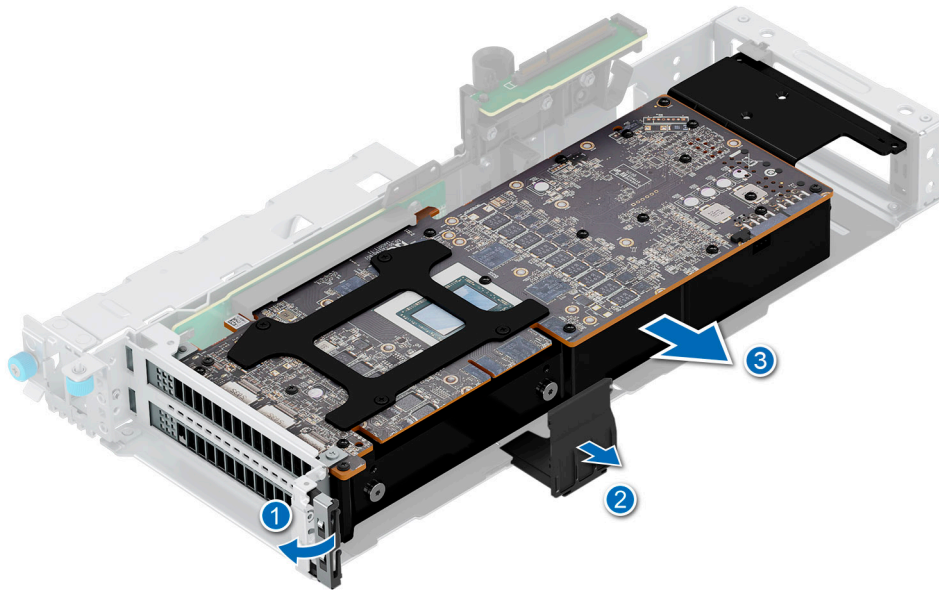

Figure 160. Removing GPU from Riser 1

2. To remove the GPU from Riser 4:
 - a. Slide the expansion card latch on the riser.
 - b. Press the tab, and pull the card holder from the riser.
 - c. Tilt the expansion card holder latch on the riser.
 - d. Hold the GPU card by the edges and pull the card from the riser.
 - e. Disconnect the GPU power cable from the GPU card.

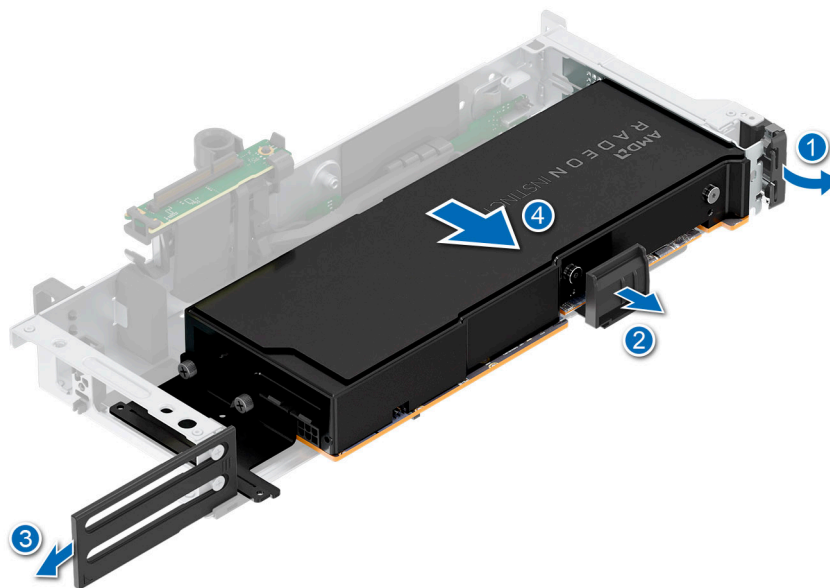

Figure 161. Removing GPU from Riser 4

3. If removing the GPU permanently, install a filler bracket.

i NOTE: You must install a filler bracket over an empty expansion card slot to maintain Federal Communications Commission (FCC) certification of the system. The brackets also keep dust and dirt out of the system and aid in proper cooling and airflow inside the system. The filler bracket is necessary to maintain proper thermal conditions.

4. Install a metal filler bracket over the empty expansion slot opening and close the expansion card latch.

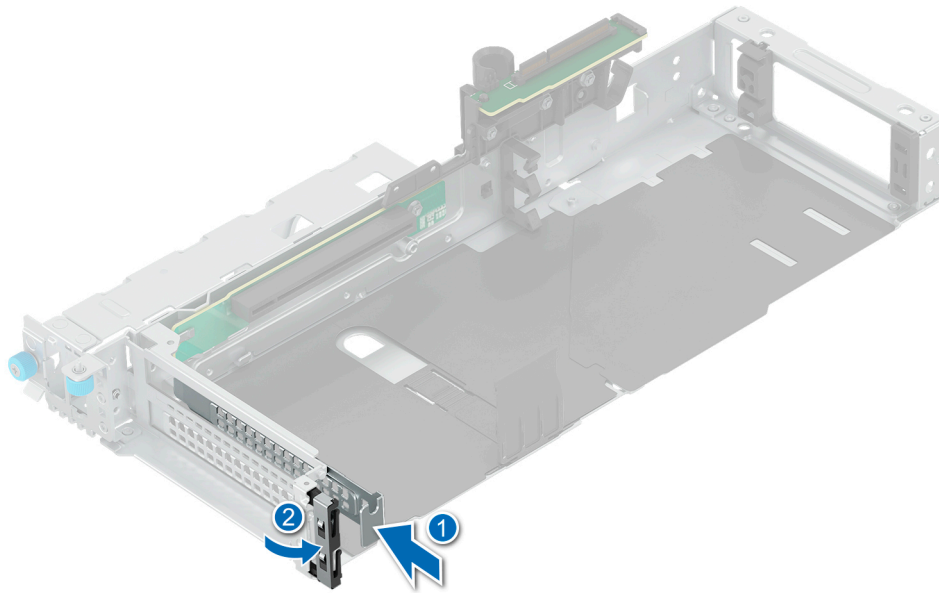

Figure 162. Installing the metal filler bracket (Riser 1)

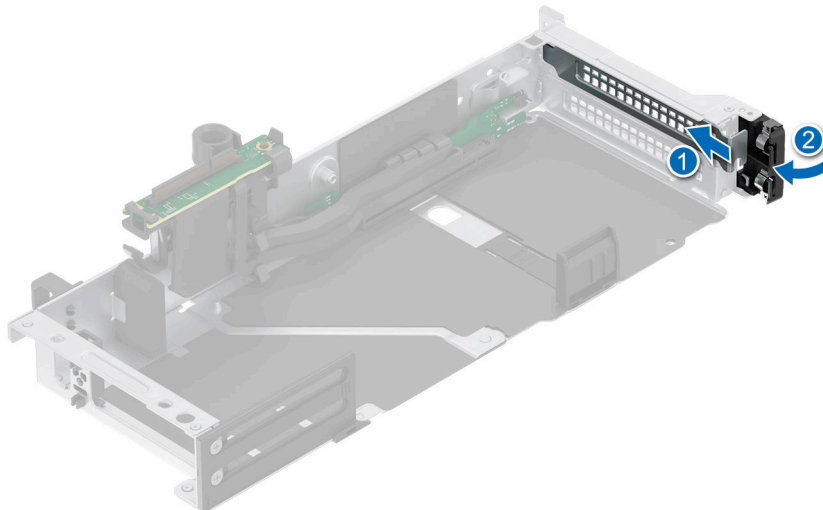

Figure 163. Installing the metal filler bracket (Riser 4)

Next steps

1. [Replace the GPU.](#)

Installing a GPU

Prerequisites

1. Follow the safety guidelines listed in the [Safety instructions](#).
2. Follow the procedure listed in [Before working inside your system](#).
3. If installing a new expansion card, unpack it and prepare the card for installation.

NOTE: For instructions, see the documentation accompanying the card.

4. [Remove the GPU air shroud top cover.](#)
5. [Remove the GPU air shroud filler.](#)
6. [Remove the full length expansion card riser.](#)

CAUTION: Do not install GPUs, network cards, or other PCIe devices on your system that are not validated and tested by Dell. Damage caused by unauthorized and invalidated hardware installation will null and void the system warranty.

WARNING: Consumer-Grade GPU should not be installed or used in the Enterprise Server products.

Steps

1. If installed, remove the filler bracket.

NOTE: Store the filler bracket for future use. Filler brackets must be installed in empty expansion card slots to maintain Federal Communications Commission (FCC) certification of the system. The brackets also keep dust and dirt out of the system and aid in proper cooling and airflow inside the system.

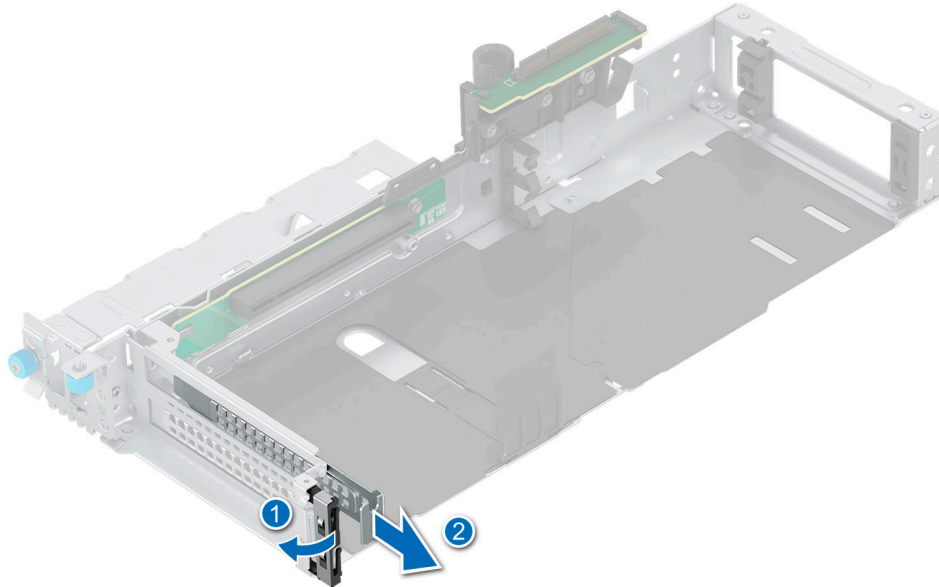

Figure 164. Removing the filler bracket(Riser 1)

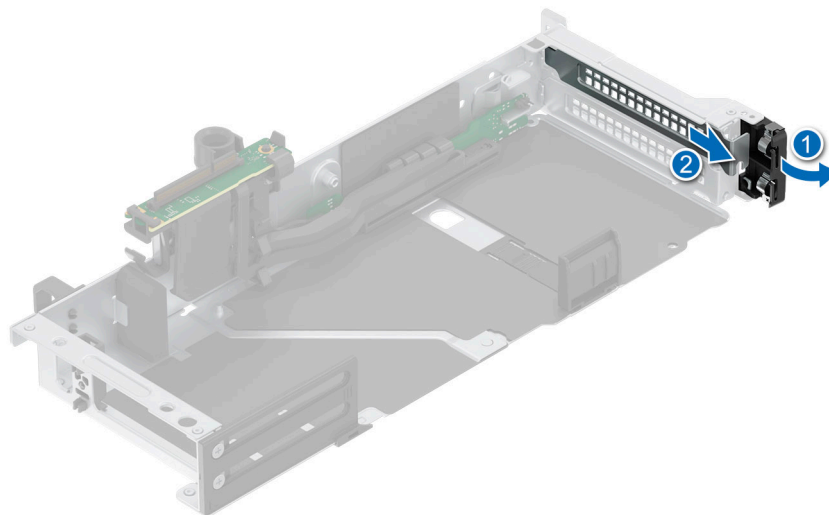

Figure 165. Removing the filler bracket(Riser 4)

2. To install the GPU on Riser 1:
 - a. Connect the GPU power cable to the GPU card.
 - b. Align the connector on the GPU with the connector on the riser.

- c. Insert the GPU into the riser until firmly seated.
- d. Tilt the expansion card holder latch.
- e. Press the card holder latch to secure the GPU card to the riser.

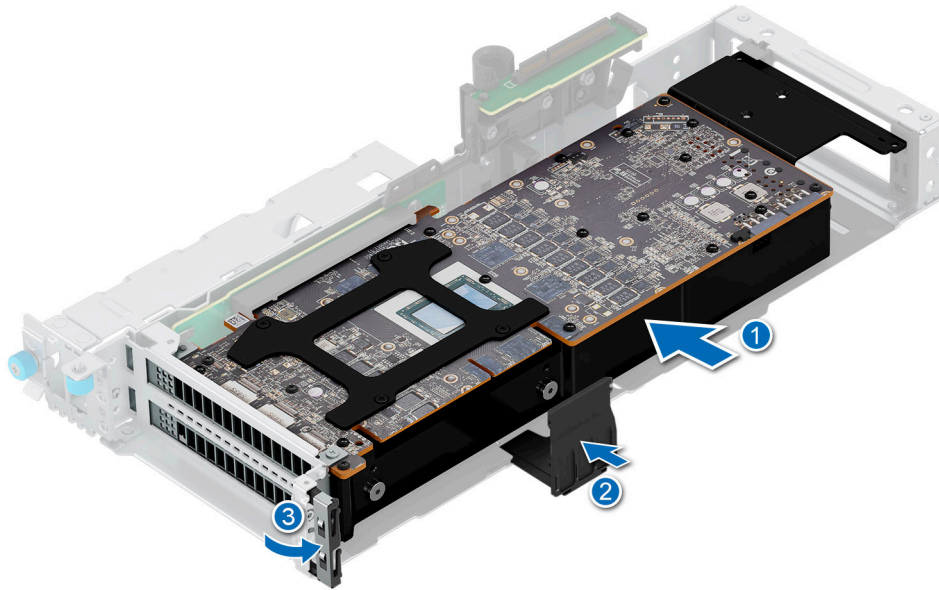

Figure 166. Installing GPU on Riser 1

- 3. To install the GPU on Riser 4:
 - a. Connect the GPU power cable to the GPU card.
 - b. Align the connector on the GPU with the connector on the riser.
 - c. Insert the GPU into the riser until firmly seated.
 - d. Tilt the expansion card holder latch.
 - e. Press the card holder latch to secure the GPU card to the riser.
 - f. Slide the expansion card latch on the riser.

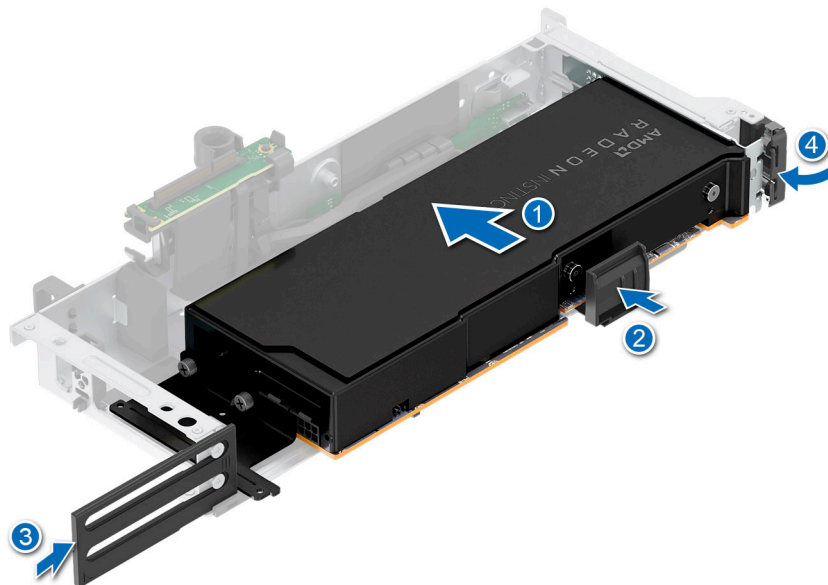

Figure 167. Installing GPU on Riser 4

Next steps

- 1. If removed, [install the GPU air shroud](#) .

2. Install the full length expansion card riser.
3. Install the GPU air shroud top cover.
4. Follow the procedure listed in [After working inside your system](#).
5. Install any device drivers required for the card as described in the documentation for the card.

Optional serial COM port

Removing the serial COM port

Prerequisites

1. Follow the safety guidelines listed in the [Safety instructions](#).
2. Follow the procedure listed in the [Before working inside your system](#).
3. [Remove the air shroud](#) or [remove the GPU air shroud](#).
4. [Remove expansion card riser](#)
- 5.

NOTE: The serial COM port is supported only in slot 4 or slot 8 of the expansion card riser.

Steps

1. Loosen the captive screws on the system.
2. Press the blue release tab or blue button on the riser and holding the edges lift the expansion card riser from the riser connector on the system board.
3. Disconnect the serial COM port cable from the serial port.

WARNING: Ensure not to pull the riser far away before unlatch cable to prevent damaging the cable latch.

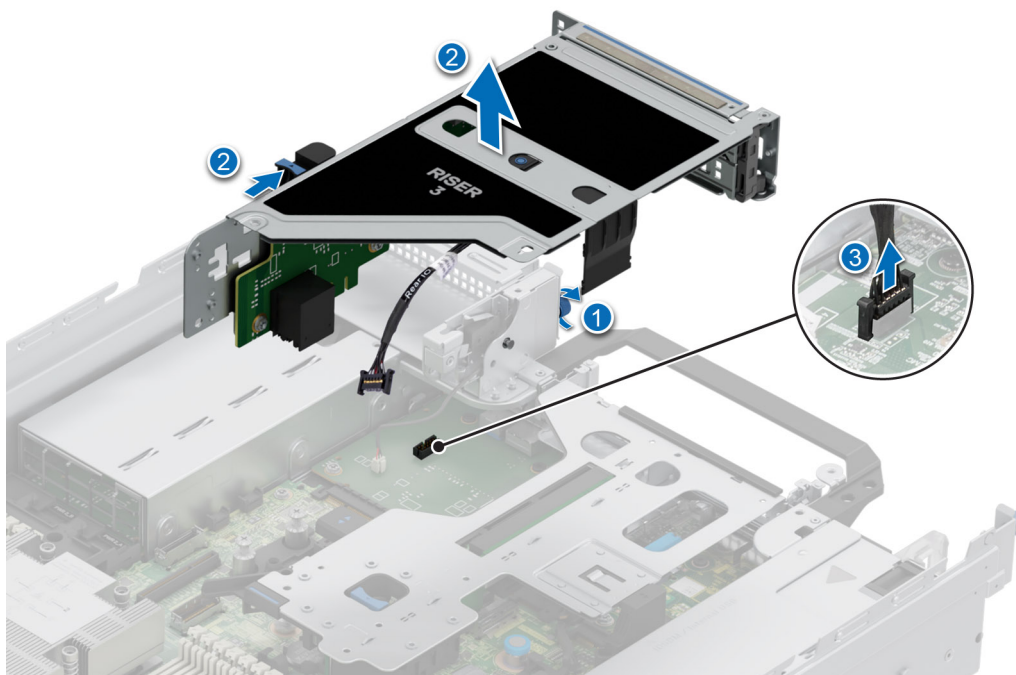

Figure 168. Disconnecting the Serial COM port

4. Open the latch on the expansion card riser and slide the serial COM port out of the expansion card riser.

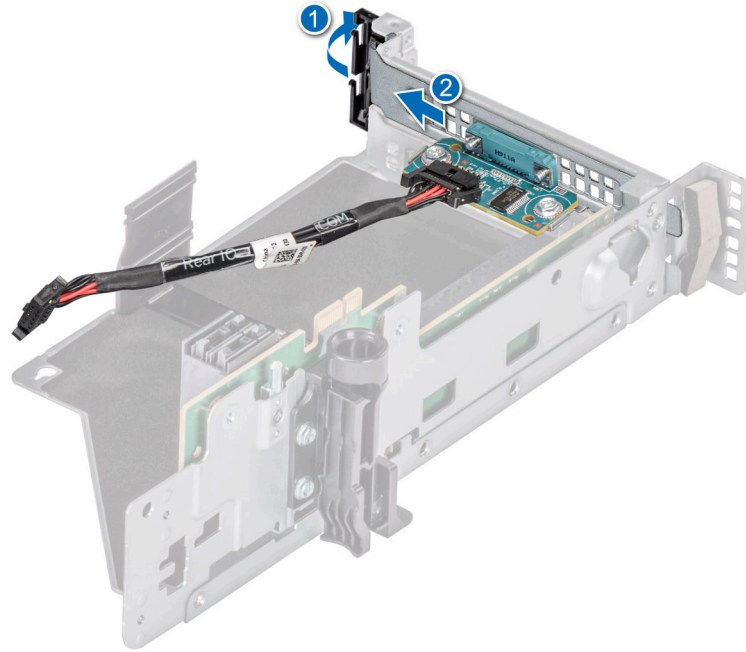

Figure 169. Removing the Serial COM port

5. Install the filler bracket if not replacing the serial COM port.

Next steps

1. [Replace the serial COM port.](#)

Installing the serial COM port

The procedure to install serial COM port to Riser 3 or 4 is same.

Prerequisites

1. Follow the safety guidelines listed in the [Safety instructions](#).
2. Follow the procedure listed in [Before working inside your system](#).
3. [Remove the air shroud](#) or [remove the GPU air shroud](#).
- i** **NOTE:** The serial COM port is supported only in slot 4 or slot 8 of the expansion card riser.
4. [Remove expansion card riser](#).
5. Disconnect the serial COM port cable from the connector on the rear I/O board.

Steps

1. Open the latch on the expansion card riser and remove the filler bracket from the expansion card riser.

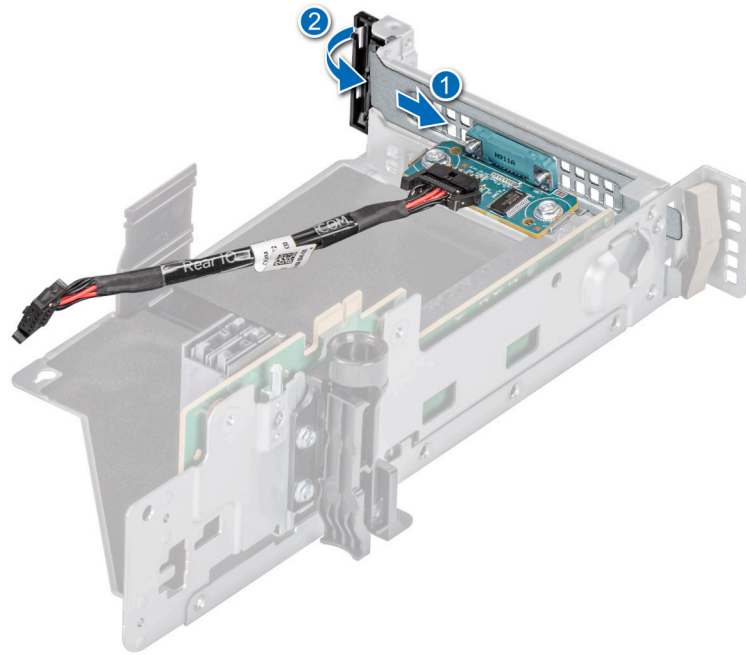

Figure 170. Installing the Serial COM port

2. Slide the serial COM port into the expansion card riser.
3. Connect the serial COM port cable to the serial port.

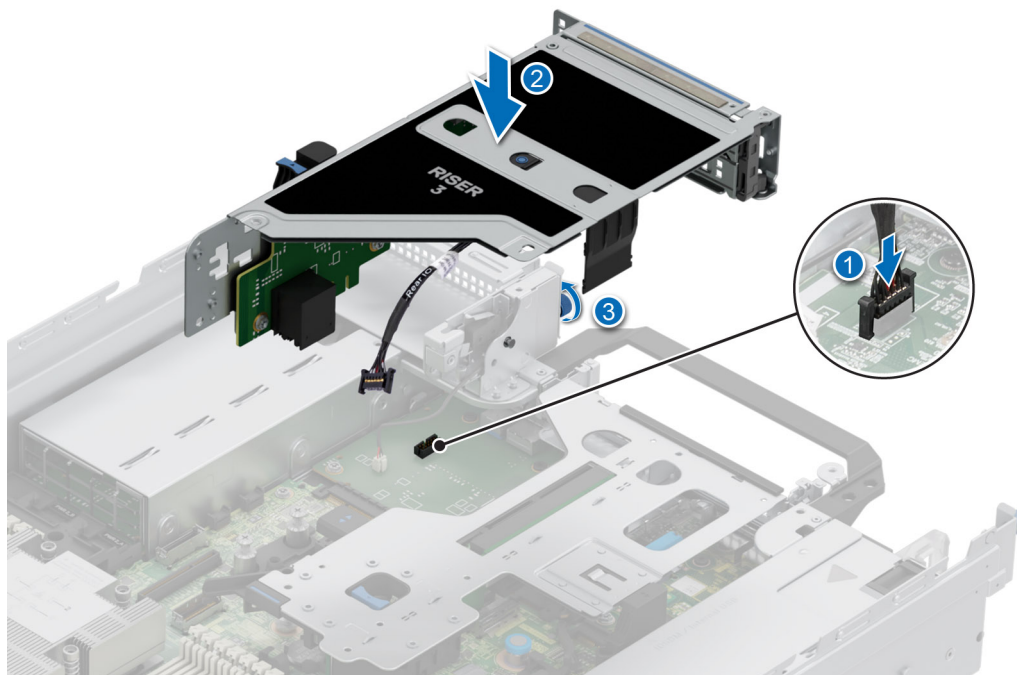

Figure 171. Installing the Serial COM port

Next steps

1. Reconnect the serial COM port cable to the connector on the rear I/O board.
2. [Install the expansion card riser.](#)
3. [Install the air shroud](#) or [install the GPU air shroud.](#)
4. Follow the procedure listed in [After working inside your system.](#)

BOSS-N1 module

Removing the BOSS-N1 module blank

Prerequisites

Follow the safety guidelines listed in the [Safety instructions](#).

Steps

Use a screwdriver to push out the blank from the BOSS-N1 module bay.

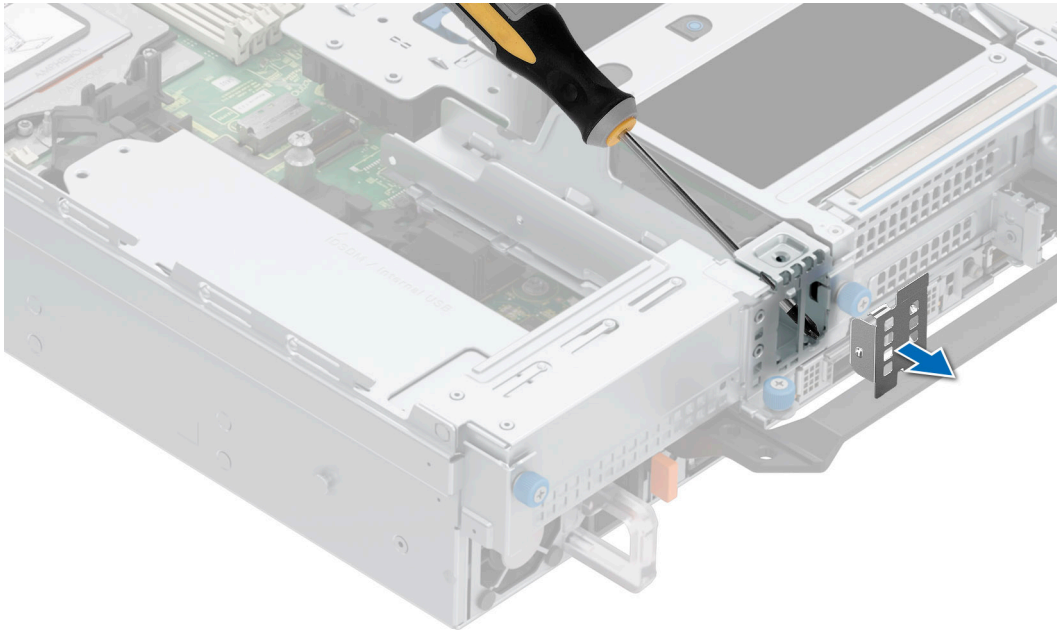

Figure 172. Removing the BOSS-N1 module blank

Next steps

1. [Replace the BOSS-N1 module blank](#) or [install BOSS-N1 module](#).

Installing the BOSS-N1 module blank

Prerequisites

1. Follow the safety guidelines listed in the [Safety instructions](#).

Steps

Align the blank with the BOSS-N1 module bay and push it into the bay until it clicks into place.

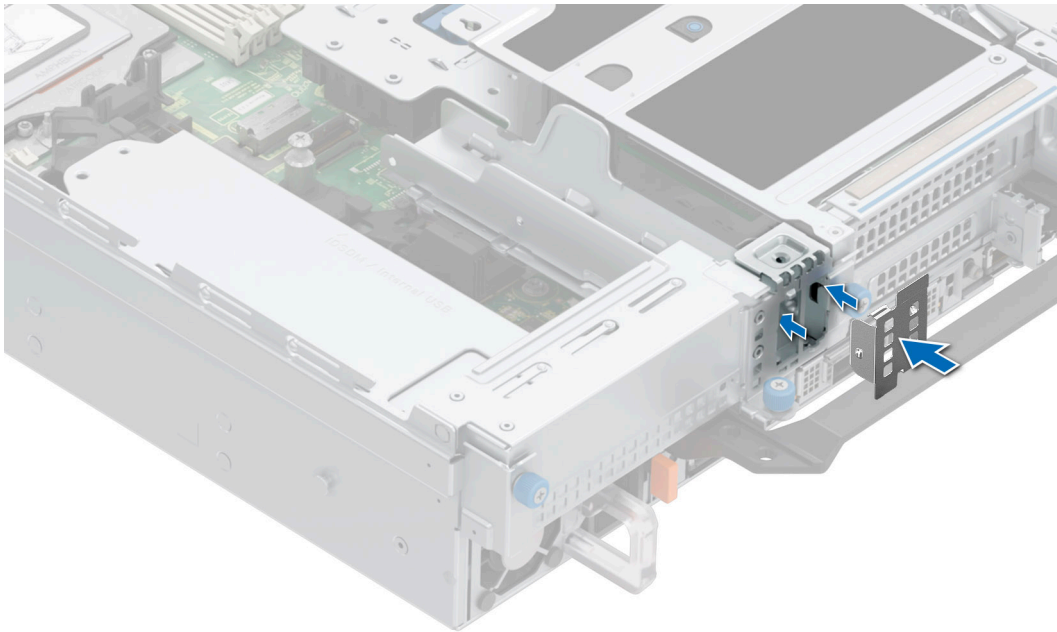

Figure 173. Installing the BOSS-N1 module blank

Removing the BOSS card filler

Prerequisites

1. Follow the safety guidelines listed in the [Safety instructions](#).
2. Follow the procedure listed in [Before working inside your system](#).

Steps

Press and pull the BOSS card filler out from the BOSS-N1 controller card module bay.

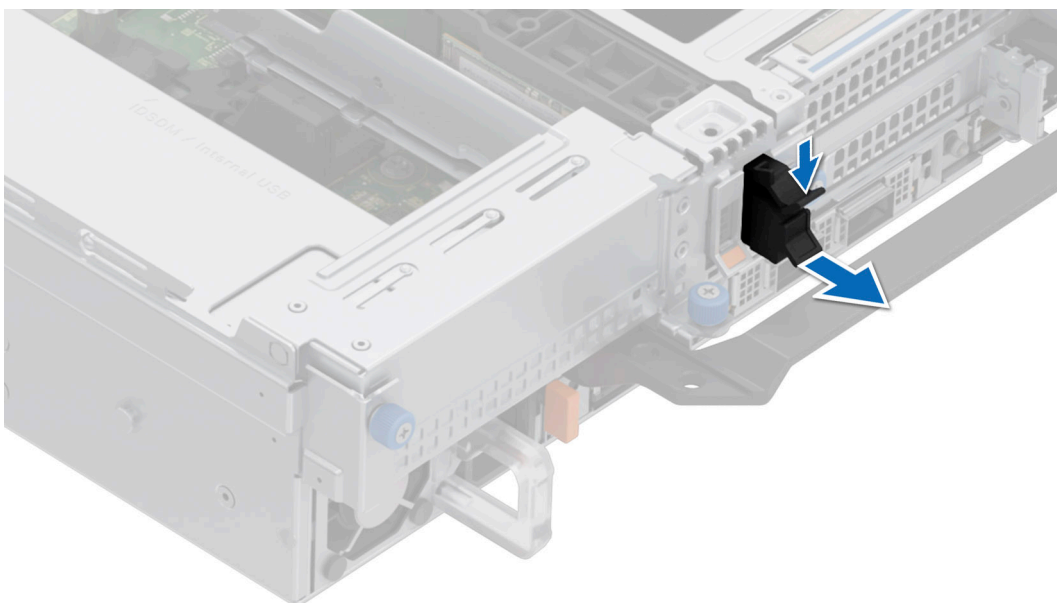

Figure 174. Removing the BOSS card filler

Next steps

1. [Replace the BOSS card filler](#) or [BOSS-N1 controller card module](#).

Installing the BOSS card filler

Prerequisites

1. Follow the safety guidelines listed in the [Safety instructions](#).

Steps

Align the BOSS card filler with the BOSS-N1 controller card module bay and push it into the bay until it clicks into place.

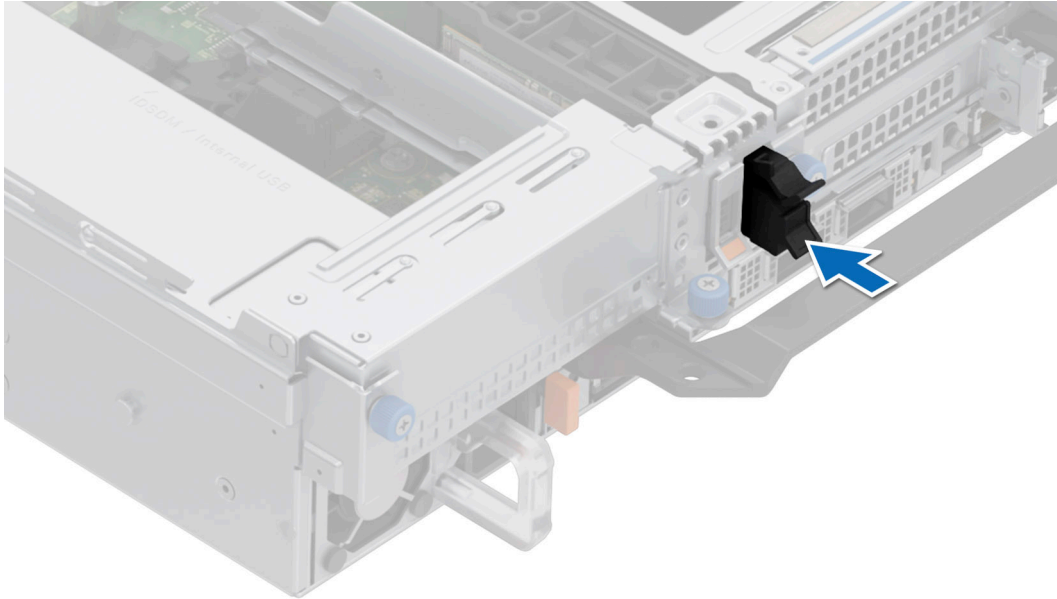

Figure 175. Installing the BOSS card filler

Removing the BOSS-N1 controller card module

Prerequisites

1. Follow the safety guidelines listed in the [Safety instructions](#).
2. Follow the procedure listed in [Before working inside your system](#).

Steps

1. Pull and lift the BOSS-N1 card carrier retention latch lock to open.
2. Slide the BOSS-N1 card carrier out.

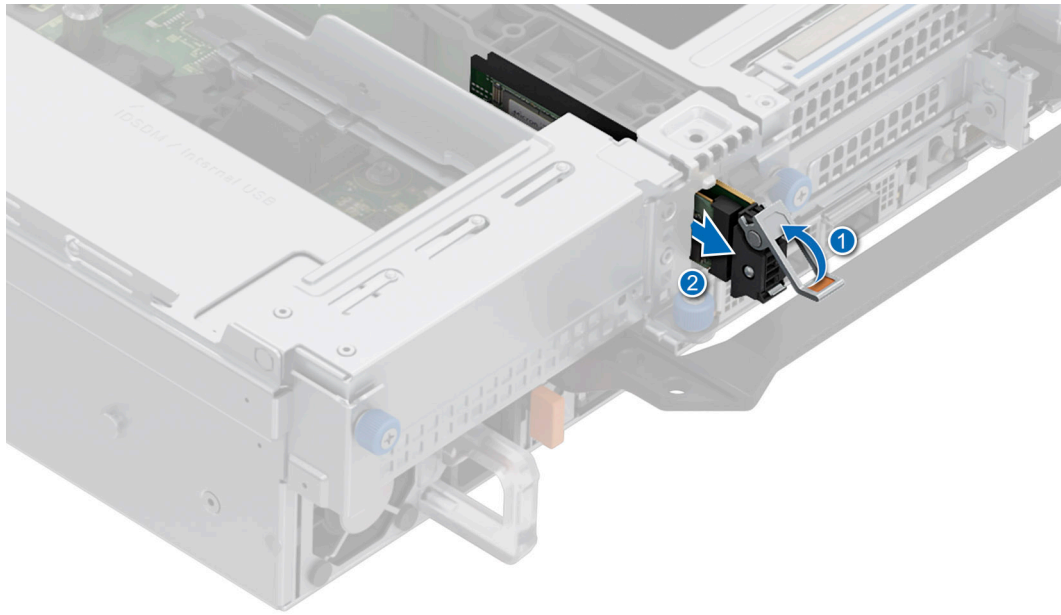

Figure 176. Removing the BOSS-N1 card carrier

3. Using the Phillips #1 screwdriver remove the M3 x 0.5 x 4.5 mm screw that secures the M.2 SSD to the BOSS-N1 card carrier.
4. Slide the M.2 SSD out and up from the BOSS-N1 card carrier.

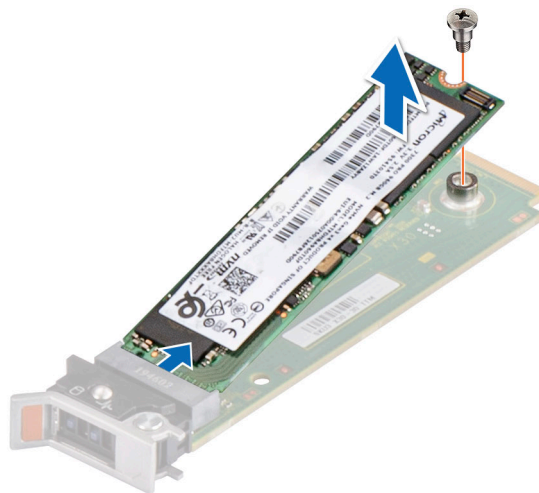

Figure 177. Removing the M.2 SSD

5. Disconnect the BOSS-N1 power cable and signal cable from the system board.
- i** **NOTE:** If BOSS-N1 module is installed, ensure to disconnect the BOSS-N1 power cable and signal cable before removing the Riser 1 cage.
6. Using the Phillips #1 screwdriver remove the M3 x 0.5 x 4.5 mm screw that secures the BOSS-N1 module on Riser 1.

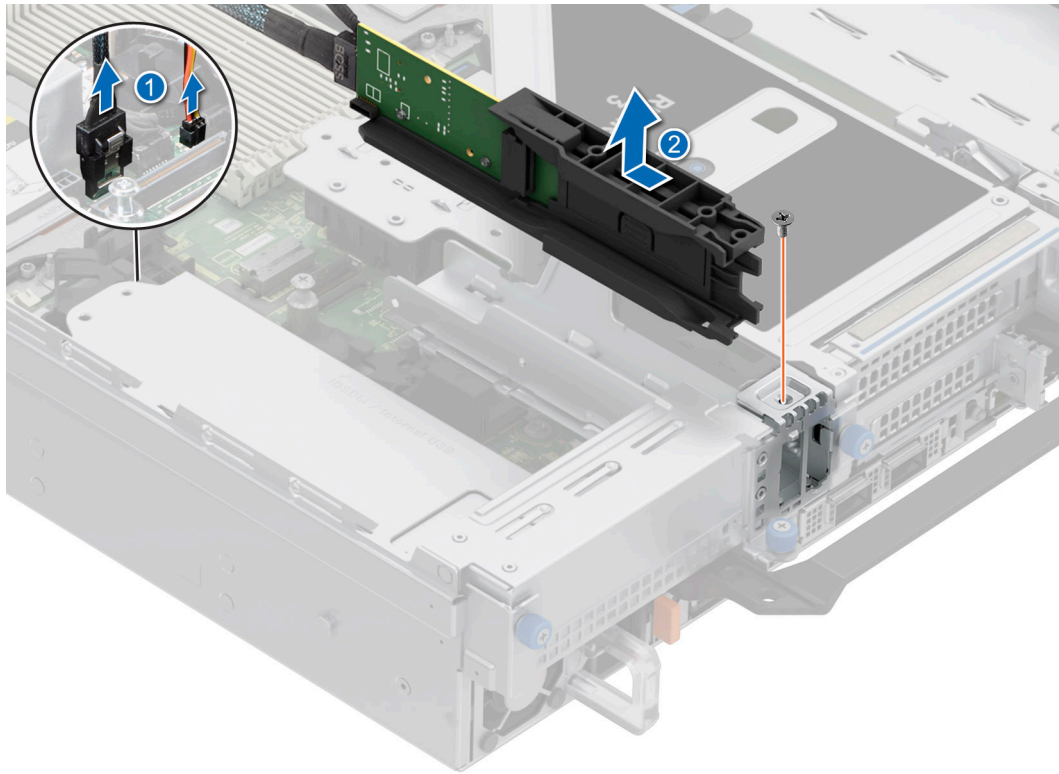

Figure 178. Removing the BOSS-N1 controller card module

7. Slide the BOSS-N1 module towards the front of the chassis and lift the module.

Next steps

1. [Replace the BOSS-N1 controller card module](#) or [Replace the BOSS card filler](#)

Installing the BOSS-N1 controller card module

Prerequisites

1. Follow the safety guidelines listed in the [Safety instructions](#).
2. Follow the procedure listed in the [Before working inside your system](#).
3. If installed, [remove the BOSS module blank](#).

Steps

1. Align the BOSS-N1 module at an angle with the controller card module slot.
2. Insert the BOSS-N1 controller card module and push the module towards the rear of the system until it is secured.
3. Using the Phillips #1 screwdriver, secure the BOSS-N1 controller card module with the M3 x 0.5 x 4.5 mm screw.
4. Connect the BOSS power and signal cable to the connectors on the system board.

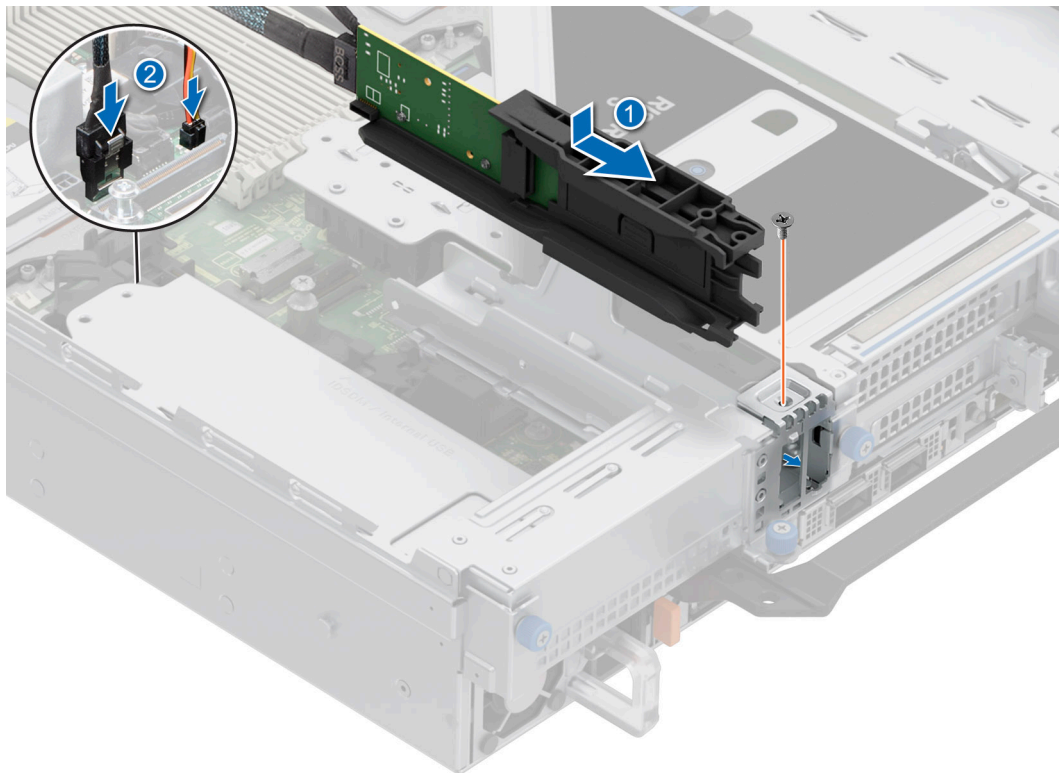

Figure 179. Installing the BOSS-N1 controller card module

5. Align the M.2 SSD at an angle with the BOSS-N1 card carrier.
6. Insert the M.2 SSD until it is firmly seated in the BOSS-N1 card carrier.
7. Using the Phillips #1 screwdriver, secure the M.2 SSD on the BOSS-N1 card carrier with the M3 x 0.5 x 4.5 mm screw.

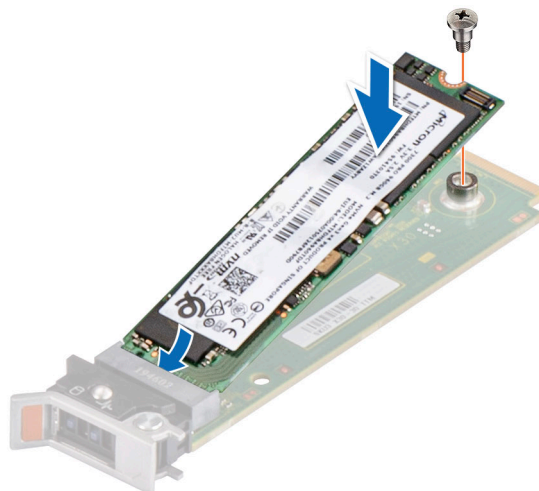

Figure 180. Installing the M.2 SSD

8. Slide the BOSS-N1 card carrier into the BOSS-N1 module slot.
9. Close the BOSS-N1 card carrier release latch to lock the carrier in place.

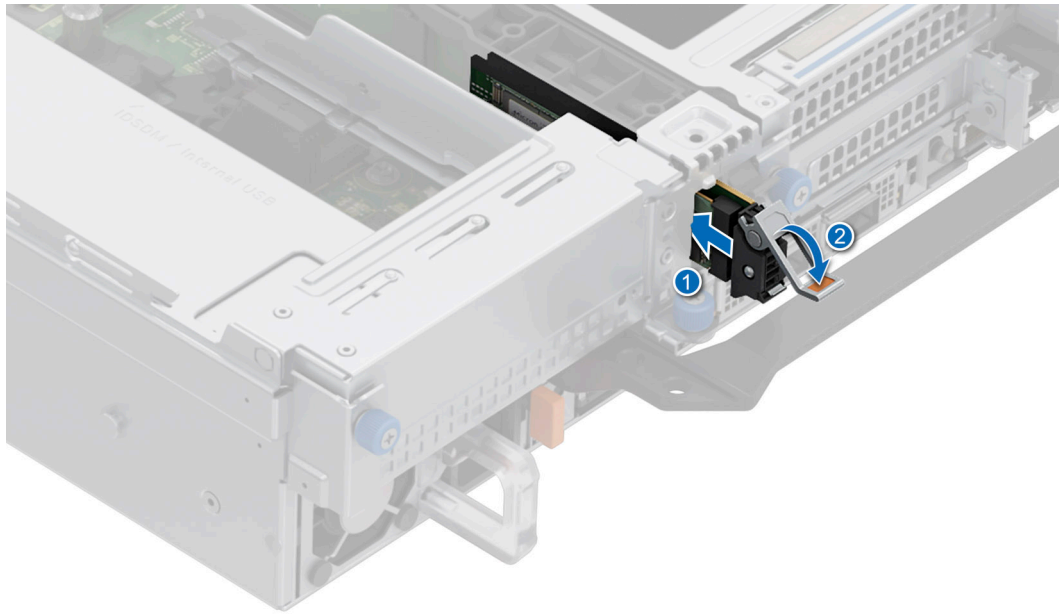

Figure 181. Installing the BOSS-N1 card carrier

Next steps

1. Follow the procedure listed in the [After working inside your system](#).

System battery

This is a service technician replaceable part only.

Replacing the system battery

Prerequisites

⚠ WARNING: There is a danger of a new battery exploding if it is incorrectly installed. Replace the battery only with the same or equivalent type That is recommended by the manufacturer. Discard used batteries according to the manufacturer's instructions. See the Safety instructions. that came with your system for more information.

1. Follow the safety guidelines listed in the [Safety instructions](#).
2. Follow the procedure listed in the [Before working inside your system](#).
3. If applicable, disconnect the power or data cables from the expansion cards.
4. [Remove the expansion card risers](#).

Steps

1. To remove the battery:
 - a. Use a plastic scribe to pry out the system battery.

⚠ CAUTION: To avoid damage to the battery connector, you must firmly support the connector while installing or removing a battery.

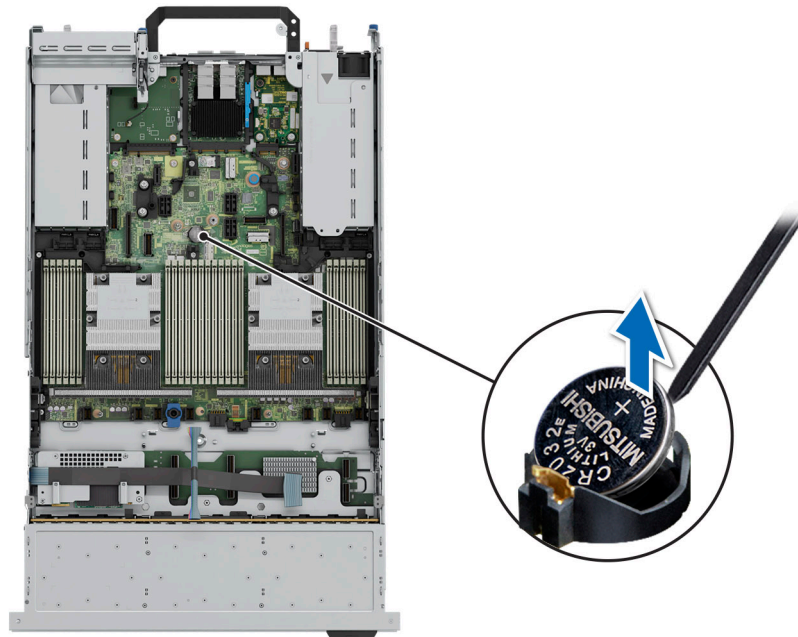

Figure 182. Removing the system battery

2. To install a new system battery:
 - a. Hold the battery with the positive side facing up and slide it under the securing tabs.
 - b. Press the battery into the connector until it snaps into place.

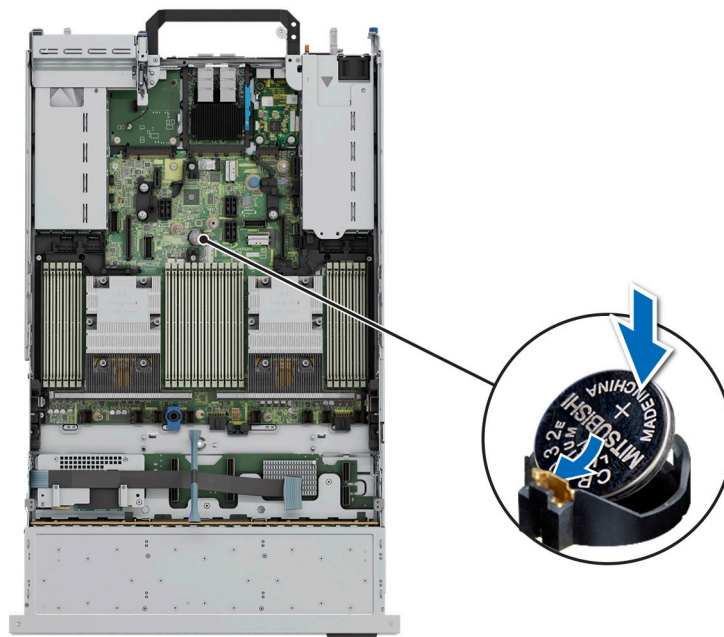

Figure 183. Installing the system battery

Next steps

1. [Install the expansion card risers.](#)
2. If applicable, connect the cables to one or more expansion cards.
3. Follow the procedure listed in [After working inside your system.](#)
4. Confirm that the battery is operating properly, by performing the following steps:
 - a. Enter the System Setup, while booting, by pressing F2.

- b. Enter the correct time and date in the System Setup **Time** and **Date** fields.
- c. **Exit** the System Setup.
- d. To test the newly installed battery, remove the system from the enclosure for at least an hour.
- e. Reinstall the system into the enclosure after an hour.
- f. Enter the System Setup and if the time and date are still incorrect, see Getting help section.

Optional internal USB card

NOTE: To locate the internal USB port on the system board, see the [System board jumpers and connectors](#) section.

Removing the internal USB card

Prerequisites

CAUTION: To avoid interference with other components in the server, the maximum permissible dimensions of the USB memory key are 15.9 mm wide x 57.15 mm long x 7.9 mm high.

1. Follow the safety guidelines listed in the [Safety instructions](#).
2. Follow the procedure listed in the [Before working inside your system](#).
3. [Remove the expansion card risers](#).

Steps

1. Holding the blue tag, lift the internal USB card to disconnect from the connector on the system board.
2. Remove the USB memory key from the internal USB card.

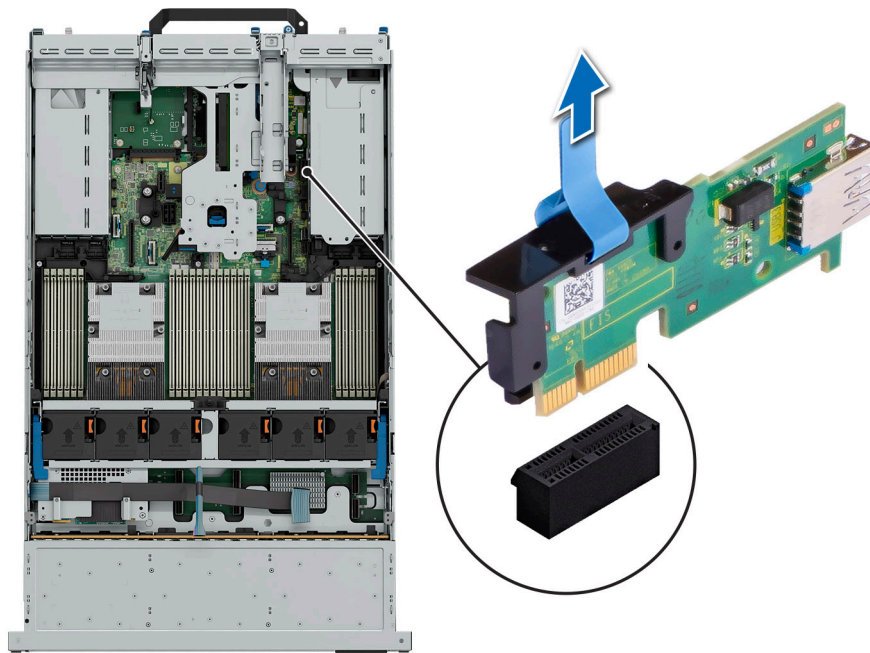

Figure 184. Removing the internal USB card

Next steps

1. [Replace the internal USB card](#).

Installing the internal USB card

Prerequisites

1. Follow the safety guidelines listed in the [Safety instructions](#).
2. Follow the procedure listed in [Before working inside your system](#).
3. [Remove the expansion card risers](#).

Steps

1. Connect the USB key to the internal USB card.

NOTE: Ensure to install the internal USB card in the IDSDM/USB card slot and not in the J_R3_PCIE_PWR connector slot.

2. Align the internal USB card with the connector on the system board and press firmly until the internal USB card is seated.

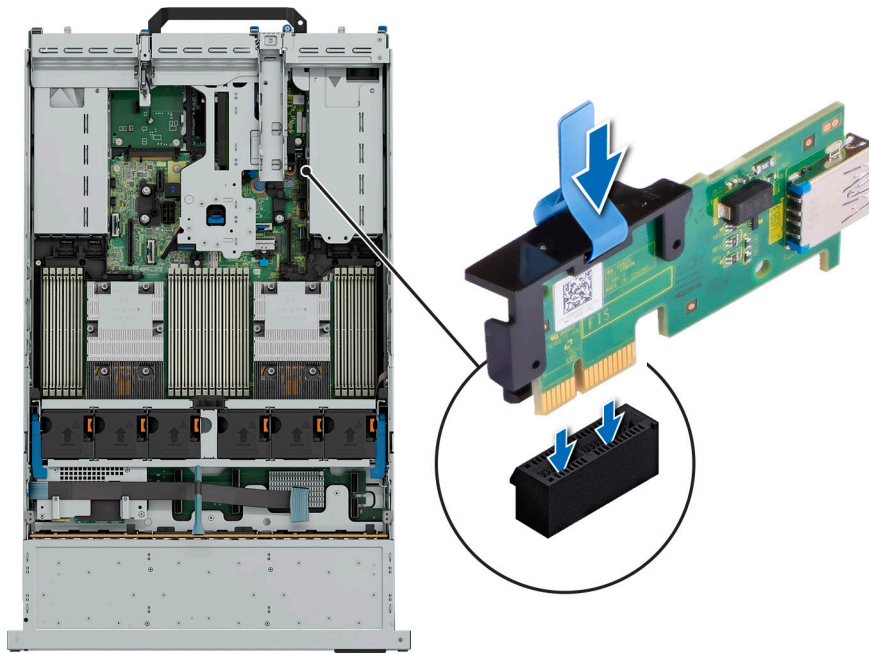

Figure 185. Installing the internal USB card

Next steps

1. [Install the expansion card risers](#).
2. Follow the procedure listed in [After working inside your system](#).
3. While booting, press F2 to enter **System Setup** and verify that the system detects the USB memory key.

Intrusion switch module

Removing the intrusion switch

Prerequisites

1. Follow the safety guidelines listed in the [Safety instructions](#).
2. Follow the procedure listed in the [Before working inside your system](#).
3. [Remove the air shroud](#).
4. Keep the plastic scribe ready.

Steps

1. Disconnect and remove the intrusion switch cable connector from connector on the system board.
NOTE: Observe the routing of the cable as you remove it from the system.
2. Using a Phillips #2 screwdriver, remove the screw that secures the intrusion switch on the intrusion switch slot.
3. Lift to remove the intrusion switch out of the intrusion switch slot.

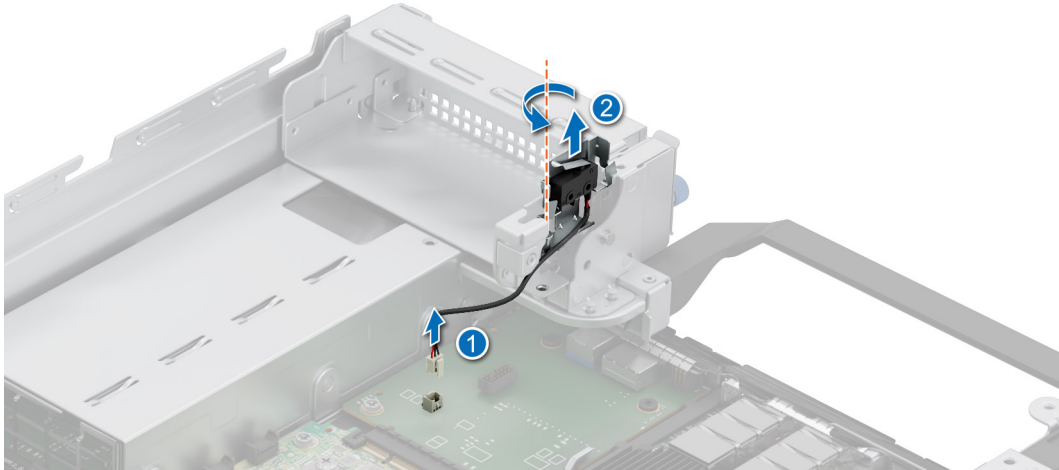

Figure 186. Removing the intrusion switch

Next steps

1. [Replace the intrusion switch.](#)

Installing the intrusion switch

Prerequisites

1. Follow the safety guidelines listed in the [Safety instructions](#).
2. Follow the procedure listed in the [Before working inside your system](#).
3. [Remove the air shroud.](#)

Steps

1. Align and insert the intrusion switch in the slot until it is firmly seated in the slot on the system.
NOTE: Route the cable properly when you replace it to prevent the cable from being pinched or crimped.
2. Using a Phillips #2 screwdriver, tighten the screw that secures the intrusion switch on the intrusion switch slot.
3. Connect the intrusion switch cable to the connector on the system board.

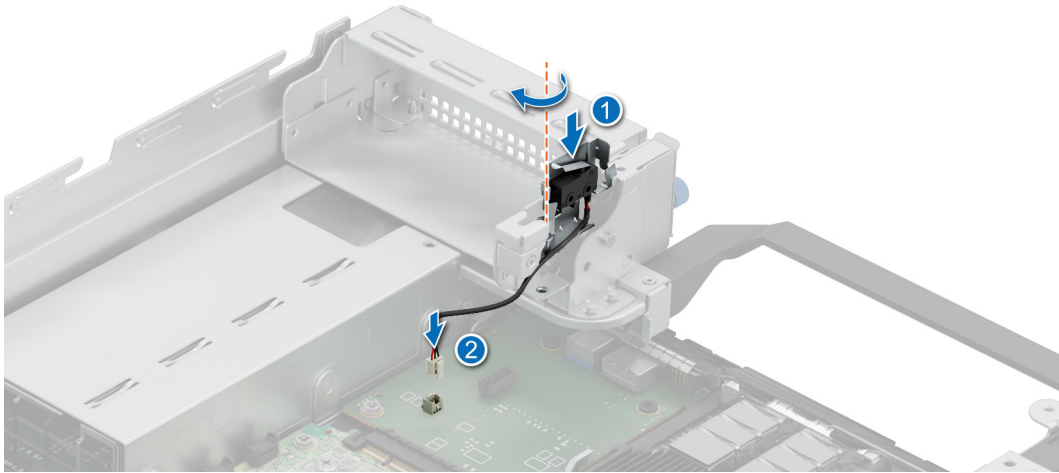

Figure 187. Installing the intrusion switch

Next steps

1. [Install the air shroud.](#)
2. Follow the procedure listed in [After working inside your system.](#)

Optional OCP card

Removing the OCP card

Prerequisites

1. Follow the safety guidelines listed in the [Safety instructions.](#)
2. Follow the procedure listed in the [Before working inside your system.](#)
3. [Remove the expansion card riser.](#)

Steps

1. Open the blue latch to disengage the OCP card.
2. Push the OCP card towards the rear end of the system to disconnect from the connector on the system board.
3. Slide the OCP card out of the slot on the system.

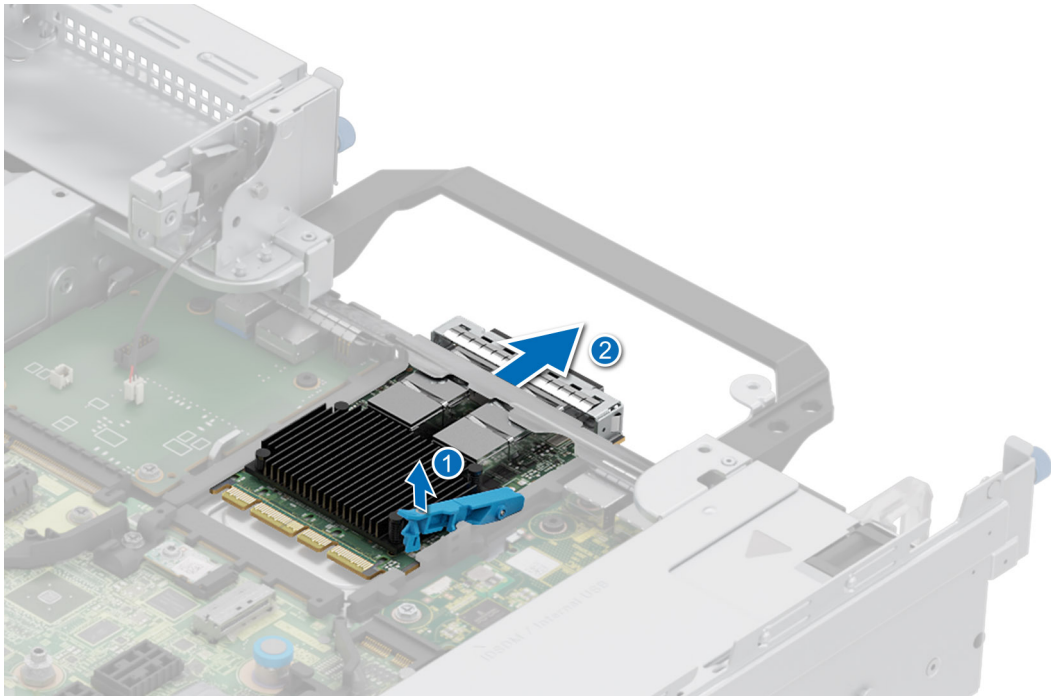

Figure 188. Removing the OCP card

4. If the OCP card is not going to be replaced, install a filler bracket .

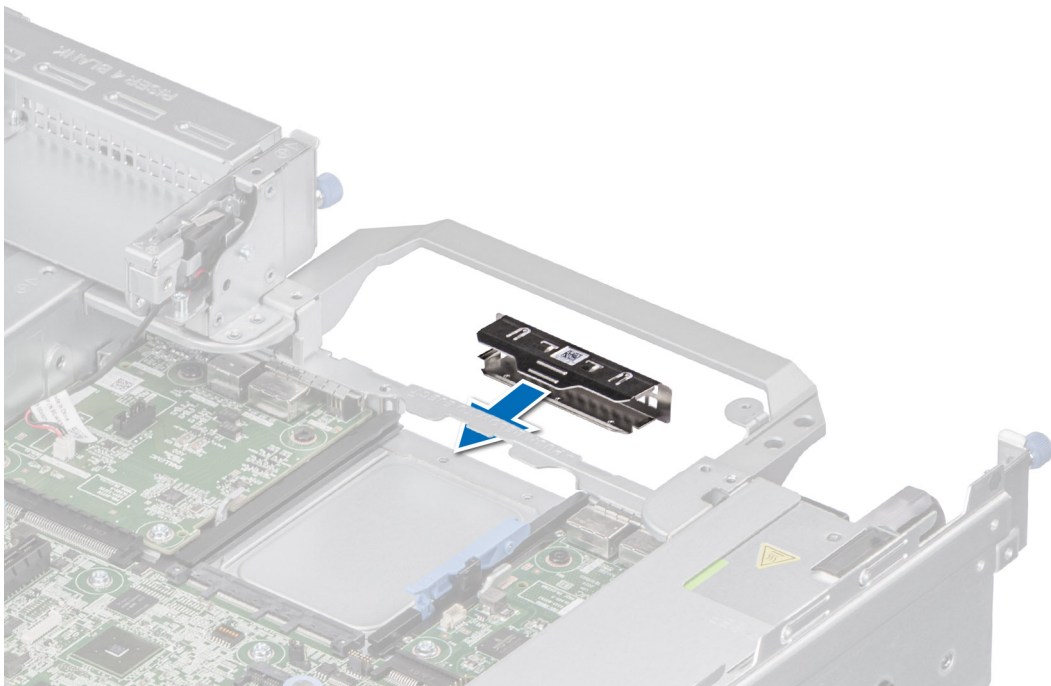

Figure 189. Installation of filler bracket

Next steps

1. [Replace the OCP card.](#)

Installing the OCP card

Prerequisites

1. Follow the safety guidelines listed in the [Safety instructions](#).
2. Follow the procedure listed in the [Before working inside your system](#).
3. [Remove the expansion card riser](#).

Steps

1. If installed, remove the filler bracket.

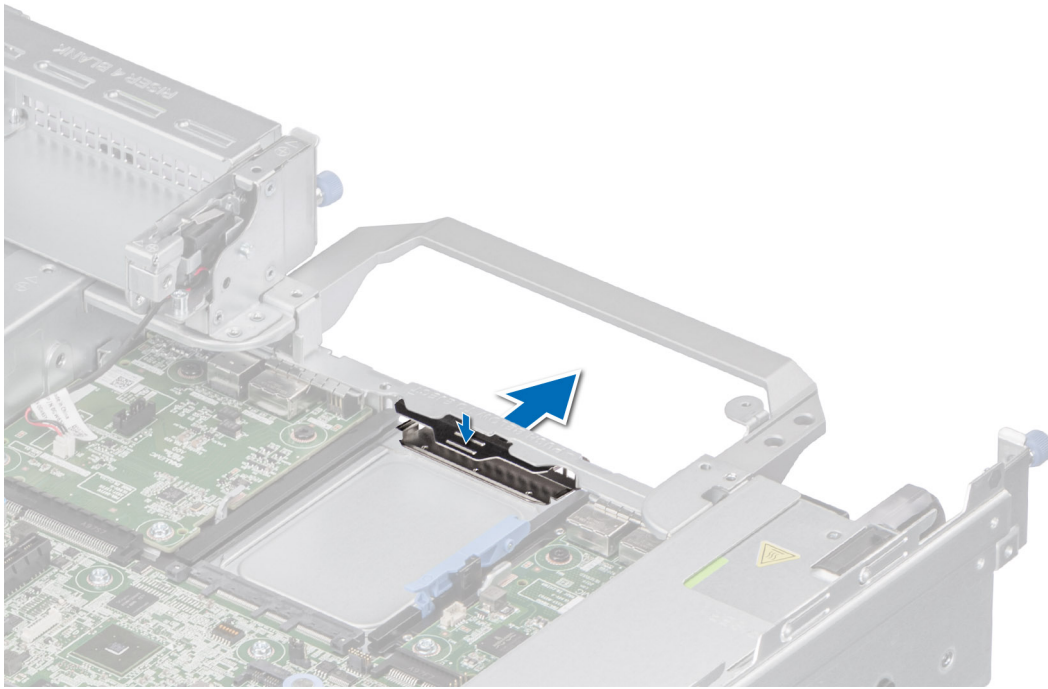

Figure 190. Removal of filler bracket

2. Open the blue latch on the system board.
3. Slide the OCP card into the slot in the system.
4. Push until the OCP card is connected to the connector on the system board.
5. Close the latch to lock the OCP card to the system.

NOTE: The numbers on the image do not depict the exact steps. The numbers are for representation of sequence.

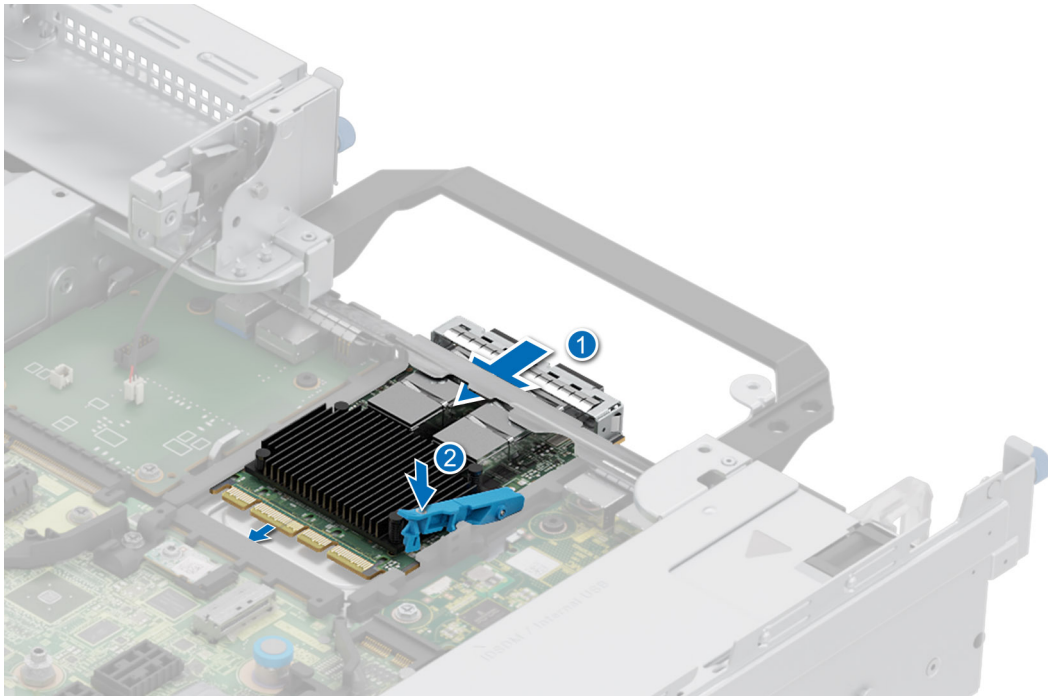

Figure 191. Installing the OCP card

Next steps

1. [Install the expansion card riser](#)
2. Follow the procedure listed in [After working inside your system](#).

Power supply unit

NOTE: While replacing the hot swappable PSU, after next server boot; the new PSU automatically updates to the same firmware and configuration of the replaced one. For more information about the Part replacement configuration, see the *Lifecycle Controller User's Guide* at <https://www.dell.com/idracmanuals>

Hot spare feature

Your system supports the hot spare feature that significantly reduces the power overhead associated with power supply unit (PSU) redundancy.

When the hot spare feature is enabled, one of the redundant PSUs is switched to the sleep state. The active PSU supports 100 percent of the system load, thus operating at higher efficiency. The PSU in the sleep state monitors output voltage of the active PSU. If the output voltage of the active PSU drops, the PSU in the sleep state returns to an active output state.

If having both PSUs active is more efficient than having one PSU in the sleep state, the active PSU can also activate the sleeping PSU.

The default PSU settings are as follows:

- If the load on the active PSU is more than 50 percent of PSU rated power wattage, then the redundant PSU is switched to the active state.
- If the load on the active PSU falls below 20 percent of PSU rated power wattage, then the redundant PSU is switched to the sleep state.

You can configure the hot spare feature by using the iDRAC settings. For more information, see the *iDRAC User's Guide* available at www.dell.com/poweredge manuals.

Removing a power supply unit blank

Prerequisites

Follow the safety guidelines listed in the [Safety instructions](#).

Steps

Pull the blank out of the system.

 **CAUTION:** To ensure proper system cooling, the PSU blank must be installed in the second PSU bay in a non-redundant configuration. Remove the PSU blank only if you are installing a second PSU.

Next steps

1. [Replace the PSU blank](#) or [PSU](#).

Installing a power supply unit blank

Prerequisites

1. Follow the safety guidelines listed in the [Safety instructions](#).
 **NOTE:** Install the power supply unit (PSU) blank only in the second PSU bay.
2. [remove the PSU](#).

Steps

Align the PSU blank with the PSU bay and push it into the PSU bay until it clicks into place.

Removing a power supply unit adapter blank

Remove the PSU adapter, when installing PSU with 86 mm wide form factor.

Prerequisites

Follow the safety guidelines listed in the [Safety instructions](#).

Steps

Using a Phillips #1 screwdriver, loosen the screw and remove the power supply unit adapter blank.

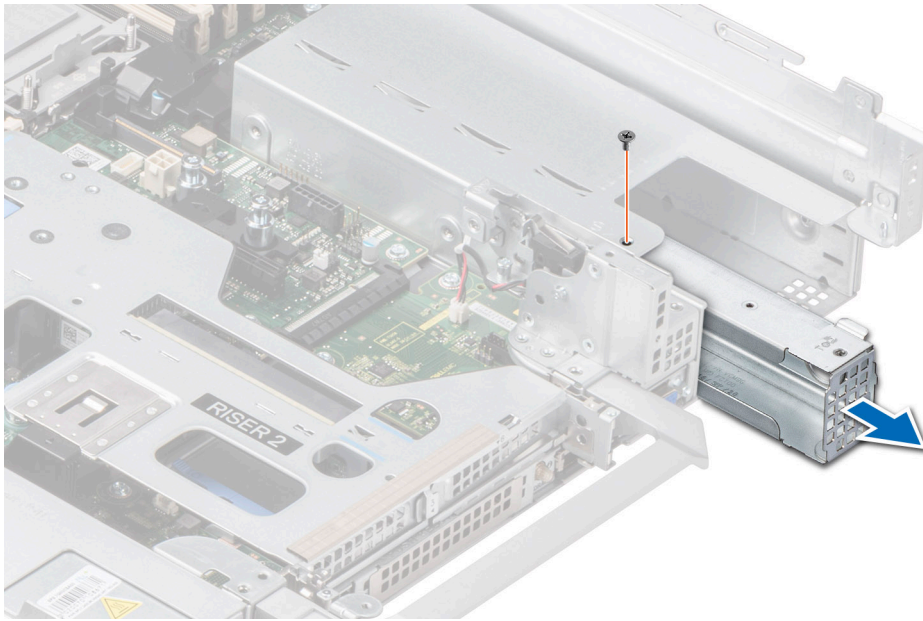

Figure 192. Removing a power supply unit adapter blank

Next steps

1. [Replace the PSU adapter](#) or [Install the PSU](#).

Installing a power supply unit adapter blank

Prerequisites

1. Follow the safety guidelines listed in the [Safety instructions](#).
2. If required, [Remove the PSU](#).

i **NOTE:** Remove the PSU adapter, when installing PSU with 86 mm wide form factor.

Steps

1. Align and insert the power supply unit adapter blank.
2. Using a phillips #1 screwdriver, tighten the screw.

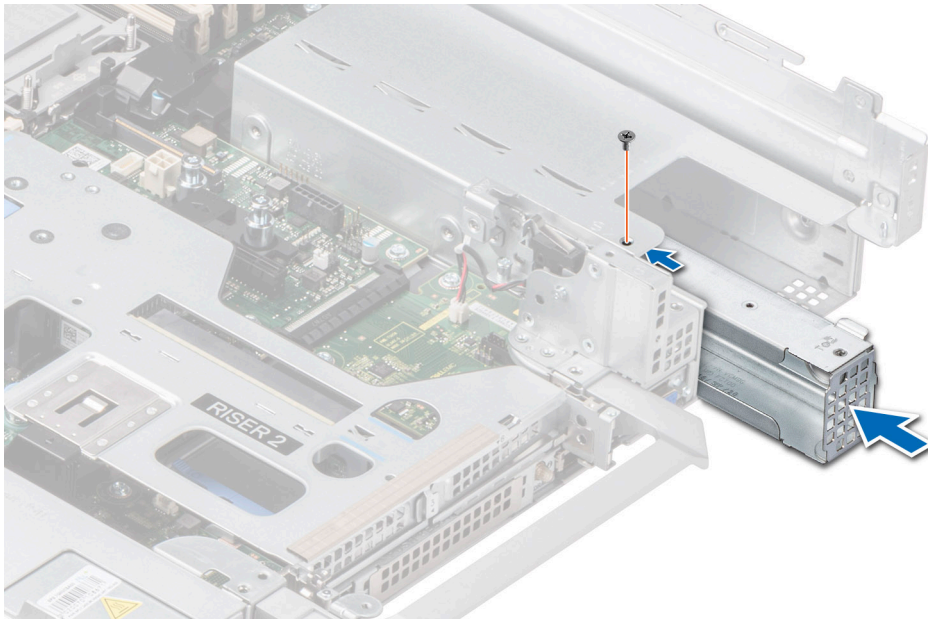

Figure 193. Installing a power supply unit adapter blank

Removing a power supply unit

Prerequisites

CAUTION: The system requires one power supply unit (PSU) for normal operation. On power-redundant systems, remove and replace only one PSU at a time in a system that is powered on.

1. Follow the safety guidelines listed in the [Safety instructions](#).
2. Disconnect the power cable from the power outlet and from the PSU you intend to remove.
3. Remove the cable from the strap on the PSU handle.
4. Unlatch and lift or remove the optional cable management accessory if it interferes with the PSU removal. For information about the cable management when the PSU is removed or installed while the system is in a rack, see the system's cable management arm documentation at <https://www.dell.com/poweredge manuals>.

Steps

Press the release latch, and holding the PSU handle slide the PSU out of the PSU bay.



Figure 194. Removing a power supply unit

Next steps

1. Replace the PSU or install the PSU blank.

Installing a power supply unit

Prerequisites

1. Follow the safety guidelines listed in the [Safety instructions](#).
2. For systems that support redundant PSU, ensure that both the PSUs are of the same type and have the same maximum output power.

NOTE: The maximum output power (shown in watts) is listed on the PSU label.

3. Remove the PSU blank.

Steps

Slide the PSU into the PSU bay until the release latch snaps into place.

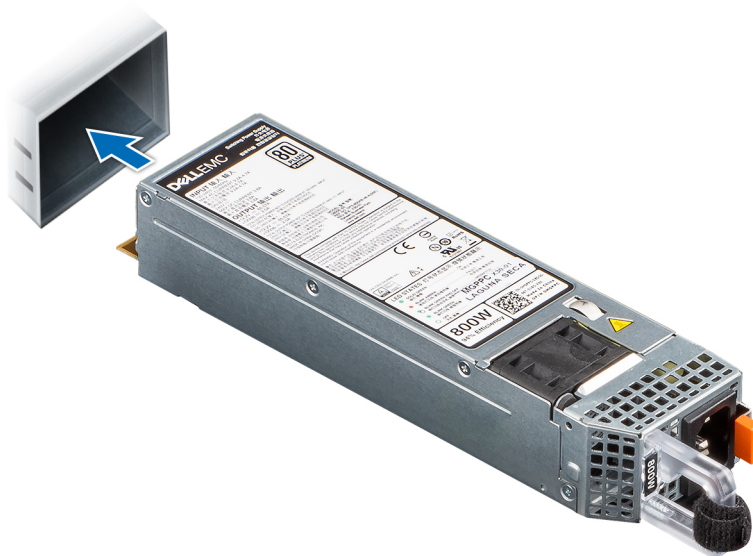

Figure 195. Installing a power supply unit

Next steps

1. If you have unlatched or removed the cable management accessory, re-install or relatch it. For information about the cable management when the PSU is removed or installed while the system is in the rack, see the system's cable management accessory documentation at <https://www.dell.com/poweredgemanuals>.
2. Connect the power cable to the PSU, and plug the cable into a power outlet.

CAUTION: When connecting the power cable to the PSU, secure the cable to the PSU with the strap.

NOTE: When installing, hot swapping, or hot adding a new PSU, wait for 15 seconds for the system to recognize the PSU and determine its status. The PSU redundancy may not occur until discovery is complete. The PSU status indicator turns green to indicate that the PSU is functioning properly.

Trusted Platform Module

This is a service technician replaceable part only.

Upgrading the Trusted Platform Module

Removing the TPM

Prerequisites

NOTE:

- Ensure the operating system is compatible with the TPM version you are installing.
- Ensure that you download and install the latest BIOS firmware on your system.
- Ensure that the BIOS is configured to enable UEFI boot mode.

CAUTION: The TPM plug-in module is cryptographically bound to that particular system board after it is installed. When the system is powered on, any attempt to remove an installed TPM plug-in module breaks the cryptographic binding, and the removed TPM cannot be installed on another system board. Ensure any keys you have stored on the TPM have been securely transferred.

Steps

1. Locate the TPM connector on the system board.
2. Press to hold the module down and remove the screw using the security Torx 8-bit shipped with the TPM module.
3. Slide the TPM module out from its connector.
4. Push the plastic rivet away from the TPM connector and rotate it 90° counterclockwise to release it from the system board.
5. Pull the plastic rivet out of its slot on the system board.

Installing the TPM

Steps

1. To install the TPM, align the edge connectors on the TPM with the slot on the TPM connector.
2. Insert the TPM into the TPM connector such that the plastic rivet aligns with the slot on the system board.
3. Press the plastic rivet until the rivet snaps into place.
4. Replace the screw that secures the TPM to the system board.

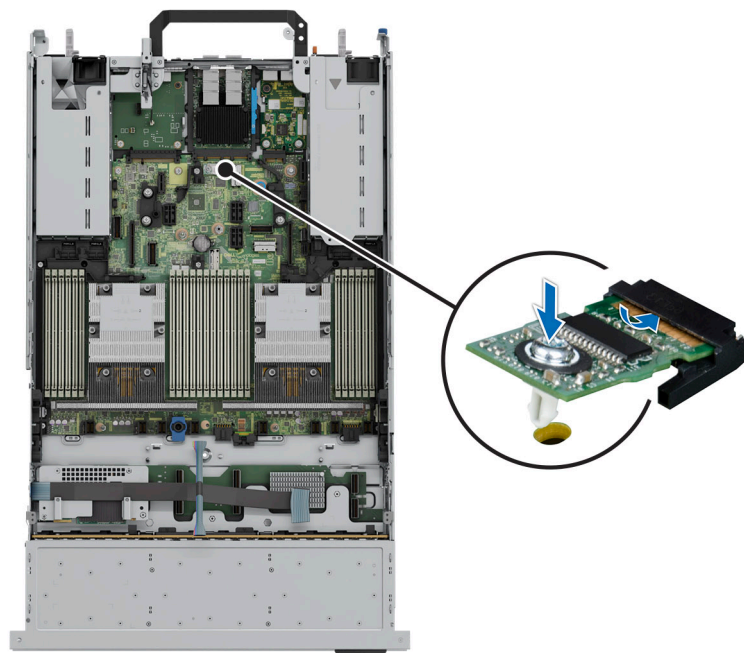

Figure 196. Installing the TPM

Initializing TPM for users

Steps

1. Initialize the TPM.
For more information, see [Initializing the TPM for users](#).
2. The **TPM Status** changes to **Enabled, Activated**.

Initializing the TPM 2.0 for users

Steps

1. While booting your system, press F2 to enter System Setup.
2. On the **System Setup Main Menu** screen, click **System BIOS > System Security Settings**.

3. From the **TPM Security** option, select **On**.
4. Save the settings.
5. Restart your system.

System board

Removing the system board

Prerequisites

 **CAUTION:** If you are using the Trusted Platform Module (TPM) with an encryption key, you may be prompted to create a recovery key during program or System Setup. Be sure to create and safely store this recovery key. If you replace this system board, you must supply the recovery key when you restart your system or program before you can access the encrypted data on your drives.

1. Follow the safety guidelines listed in the [Safety instructions](#).
2. Follow the procedure listed in the [Before working inside your system](#).
3. Remove the following components:
 - a. [Air shroud \(if installed\)](#).
 - b. [Cooling fan cage assembly](#).
 - c. [Side wall brackets](#).
 - d. [Heat sink](#).
 - e. [Processor](#).
 - f. [Memory modules](#).
 - g. [Expansion card risers](#).
 - h. [Internal USB card \(if installed\)](#).
 - i. [OCP card \(if installed\)](#).
 - j. [Power supply units \(PSU\)](#).
 - k. Disconnect all cables from the system board.

 **CAUTION:** Take care not to damage the system identification button while removing the system board from the system.

Steps

1. Using the system board holder and plunger, slide the system board towards the front of the system.
2. Lift the system board out of the chassis.

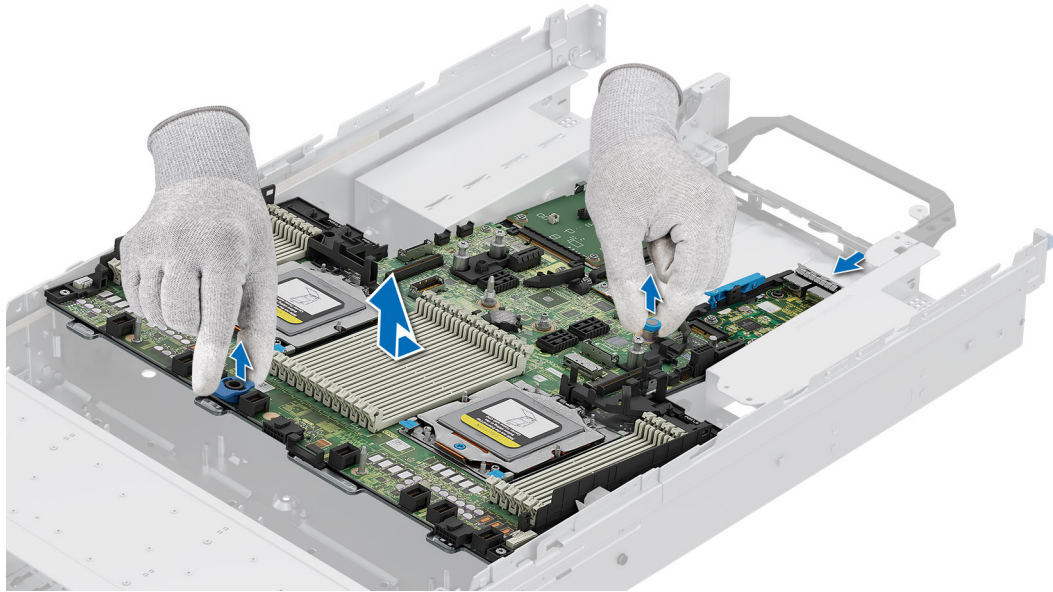

Figure 197. Removing the system board

Next steps

1. [Install the system board.](#)

Installing the system board

Prerequisites

i **NOTE:** Before replacing the system board, replace the old iDRAC MAC address label in the Information tag with the iDRAC MAC address label of the replacement system board

1. Follow the safety guidelines listed in the [Safety instructions](#).
2. Follow the procedure listed in [Before working inside your system](#).
3. If you are replacing the system board, remove all the components that are listed in the removing the system board section.

Steps

1. Unpack the new system board assembly.

⚠ CAUTION: Do not lift the system board by holding a memory module, processor, or other components.

⚠ CAUTION: Take care not to damage the system identification button while placing the system board into the chassis.

2. [Install LOM Card](#) on the system board if necessary.
3. Holding the system board holder and plunger, lower the system board into the system.
4. Slide the system board towards the rear of the chassis until the connectors are firmly seated in the slots.

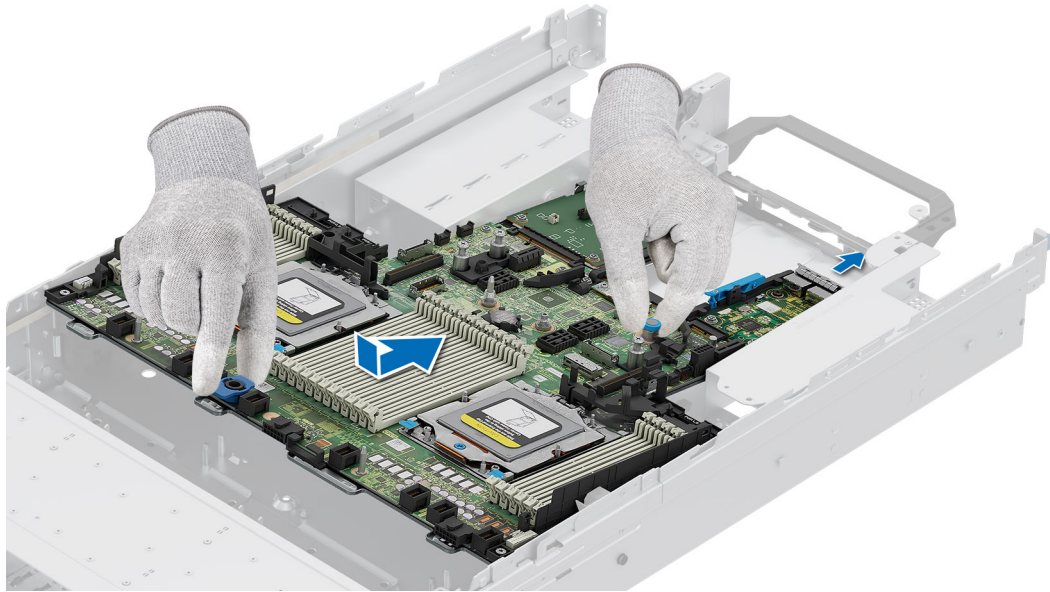

Figure 198. Installing the system board

Next steps

1. Replace the following components:
 - a. [Trusted Platform Module \(TPM\)](#).
 - NOTE:** The TPM Module must be replaced only while installing new system board.
 - b. [Internal USB card \(if installed\)](#).
 - c. [Power supply units \(PSU\)](#).
 - d. [OCP card \(if installed\)](#).
 - e. [Processor](#).
 - f. [Heat sink](#).
 - g. [Memory modules](#).
 - h. [Side wall bracket](#).
 - i. [Cooling fan cage assembly](#).
 - j. [Air shroud \(if installed\)](#).
2. Reconnect all cables to the system board.
 - NOTE:** Ensure that the cables inside the system are routed along the chassis wall and secured using the cable securing bracket.
3. Ensure that you perform the following steps:
 - a. Use the Easy Restore feature to restore the Service Tag. See the [Restoring the system by using the Easy Restore feature](#) section.
 - b. If the service tag is not backed up in the backup flash device, enter the system service tag manually. See the [Manually update the Service Tag by using System Setup](#) section.
 - c. Update the BIOS and iDRAC versions. Reenable the Trusted Platform Module (TPM). See the [Upgrading the Trusted Platform Module](#) section.

Restoring Service Tag using Easy Restore

The Easy Restore feature allows you to restore your Service Tag, iDRAC license, UEFI configuration, and the system configuration data after replacing the system board. All data is backed up in a backup Flash drive device automatically. If BIOS detects a new system board, and the Service Tag in the backup Flash drive device is different, BIOS prompts the user to restore the backup information.

Below is a list of options available:

1. Restore the service tag, license, and diagnostics information, press **Y**
2. Navigate to the Lifecycle Controller based restore options, press **N**

3. Restore data from a previously created **Hardware Server Profile**, press **F10**

i **NOTE:** When the restore process is complete, BIOS prompts to restore the system configuration data.

4. Restore data from a previously created **Hardware Server Profile**, press **F10**
5. To restore the system configuration data, press **Y**
6. To use the default configuration settings, press **N**

i **NOTE:** After the restore process is complete, system reboots.

i **NOTE:** If restoring the Service Tag is successful, you can check the Service Tag information in the **System Information** screen and compare it with the Service Tag on the system.

Manually update the Service Tag

After replacing a system board, if Easy Restore fails, follow this process to manually enter the Service Tag, using **System Setup**.

About this task

If you know the system service tag, use the **System Setup** menu to enter the service tag.

Steps

1. Power on the system.
2. To enter the **System Setup**, press **F2**.
3. Click **Service Tag Settings**.
4. Enter the service tag.

i **NOTE:** You can enter the service tag only when the **Service Tag** field is empty. Ensure that you enter the correct service tag. Once the service tag is entered, it cannot be updated or changed. Incorrectly entered service tag will lead to system board replacement.

5. Click **OK**.

LOM card and rear I/O board

Removing the LOM card and rear I/O board

Prerequisites

1. Follow the safety guidelines listed in the [Safety instructions](#).
2. Follow the procedure listed in the [Before working inside your system](#).
3. [Remove the system board](#).

Steps

1. Using a Phillips # 2 screwdriver, remove the screws that secure the LAN on Motherboard (LOM) card and rear I/O board to the system board.
2. Holding the edges, pull the LOM card or rear I/O board to disconnect from the connector on the system board.

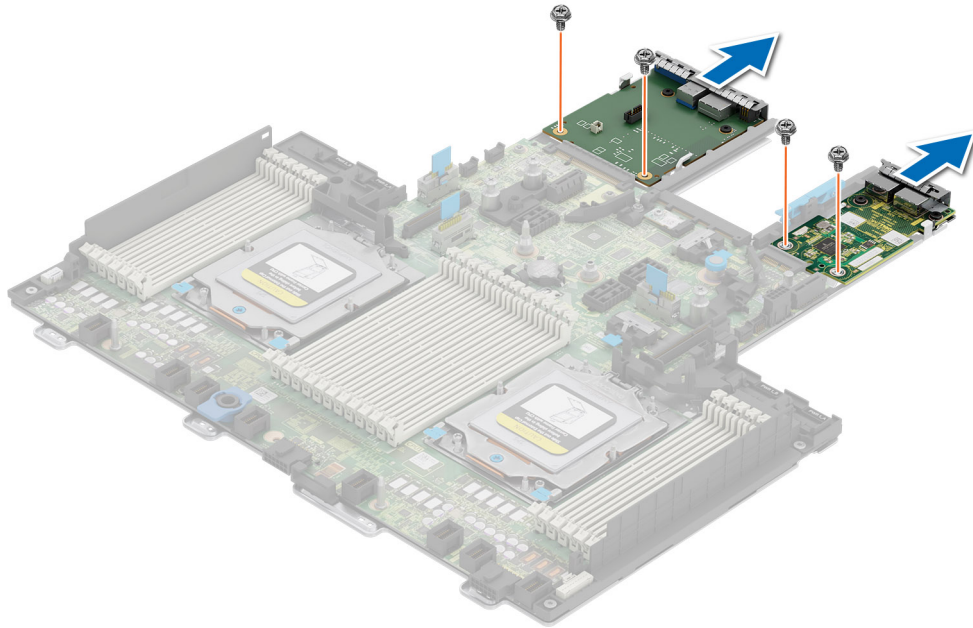

Figure 199. Removing the LOM card and rear I/O board

Next steps

1. [Replace the LOM card and rear I/O board.](#)

Installing the LOM card and rear I/O board

Prerequisites

1. Follow the safety guidelines listed in the [Safety instructions](#).
2. Follow the procedure listed in the [Before working inside your system](#).
3. [Remove the system board.](#)

Steps

1. Align the connectors and slots on the LOM card or rear I/O board with the connector and standoffs on the system board.
2. Press the LOM card or rear I/O board until firmly seated on the system board connector.
3. Using a Phillips #2 screwdriver, secure the LOM card or rear I/O board to the system board with screws.

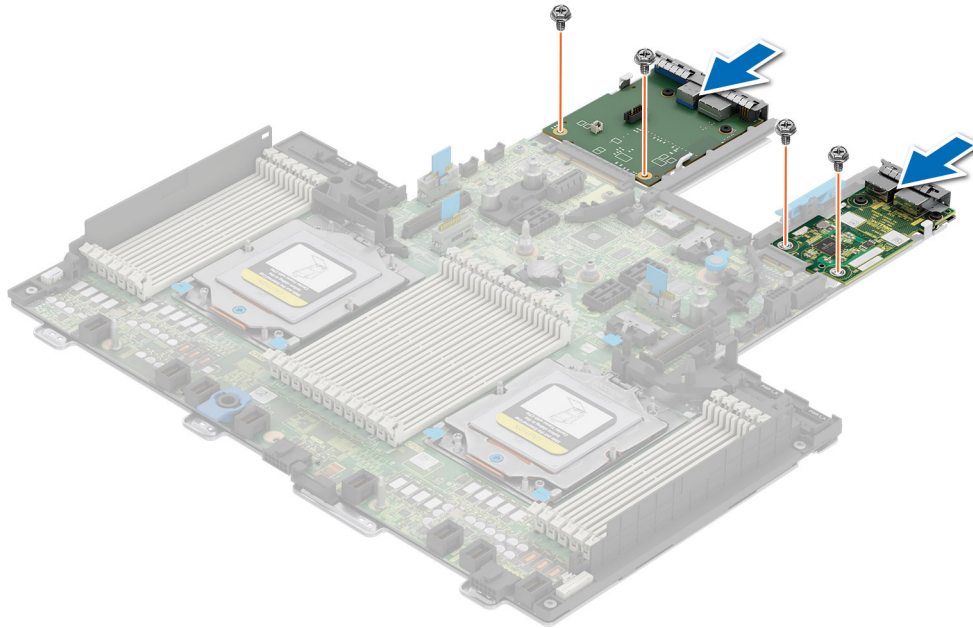

Figure 200. Installing the LOM card and rear I/O board

Next steps

1. Install the system board.
2. Follow the procedure listed in [After working inside your system](#).

Control panel

Removing the right control panel

Prerequisites

1. Follow the safety guidelines listed in the [Safety instructions](#).
2. Follow the procedure listed in the [Before working inside your system](#).
3. [Remove the drive backplane cover](#).
4. If installed, [remove the air shroud](#).
5. [Remove the cooling fan assembly](#).
6. [Remove the side wall bracket](#).

Steps

1. Using the Phillips #1 screwdriver, remove the screws that secure the right control panel and the right control panels cable cover to the system and remove the cable cover away the system.
2. Disconnect the right control panel cable and the VGA cable from the connectors on the system board.
3. Holding the cable, slide the right control panel out of the system.

NOTE: Observe the routing of the cable as you remove the right control panel from the system.

NOTE: The numbers on the image do not depict the exact steps. The numbers are for representation of sequence.

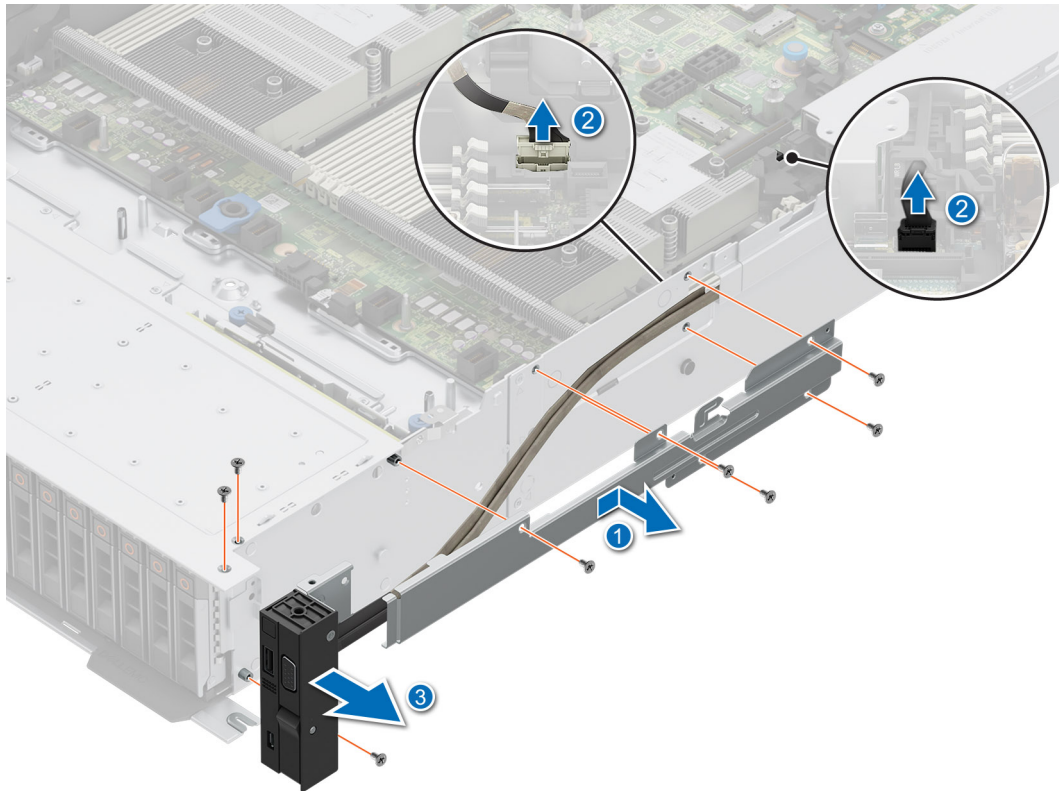

Figure 201. Removing the right control panel

Next steps

1. Replace the right control panel.

Installing the right control panel

Prerequisites

1. Follow the safety guidelines listed in the [Safety instructions](#).
2. Follow the procedure listed in [Before working inside your system](#).

Steps

1. Align and slide the right control panel in the slot on the system.
2. Connect the right control panel cable and VGA cable to the connectors on the system board.
3. Route the right control panel cable through the side wall of the system. Align and slide the right control panel cable cover in the slot on the system.

NOTE: Route the cable properly to prevent the cable from being pinched or crimped.

4. Using the Phillips #1 screwdriver, tighten the screws that secure the right control panel and the right control panel cable cover to the system.

NOTE: The numbers on the image do not depict the exact steps. The numbers are for representation of sequence.

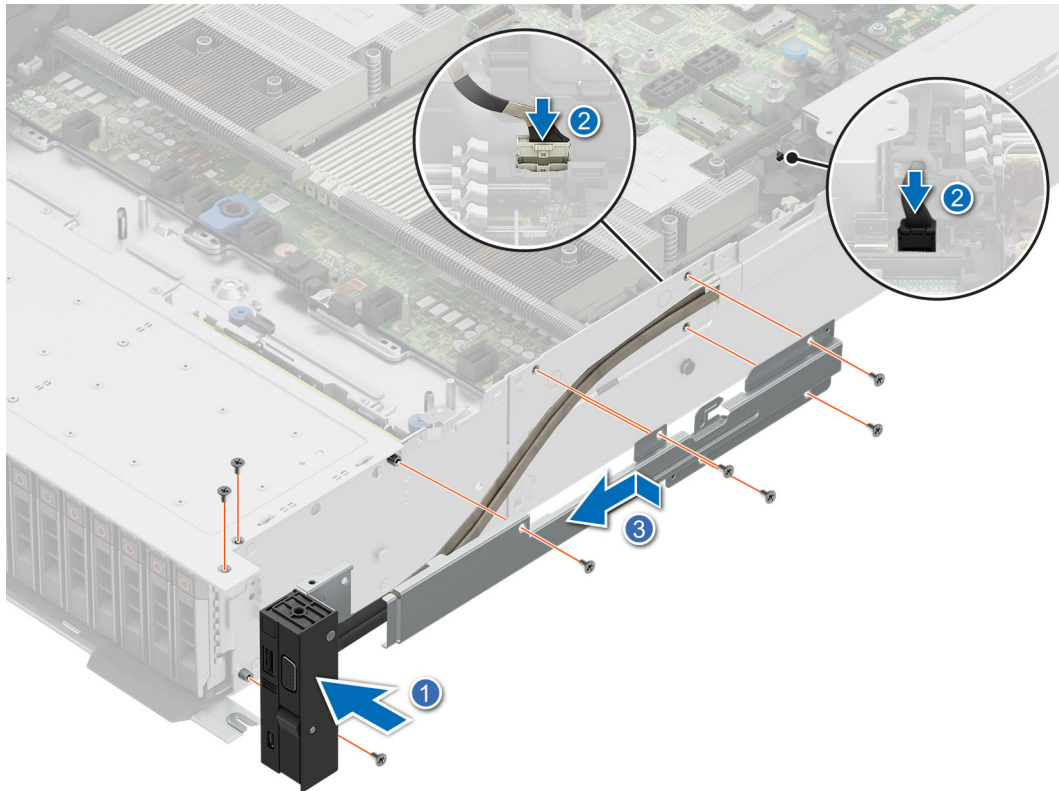

Figure 202. Installing the right control panel

Next steps

1. Install the side wall bracket.
2. Install the cooling fan assembly.
3. Install the drive backplane cover.
4. If removed, install the air shroud.
5. Follow the procedure listed in [After working inside your system](#).

Removing the left control panel

Prerequisites

1. Follow the safety guidelines listed in the [Safety instructions](#).
2. Follow the procedure listed in the [Before working inside your system](#).
3. [Remove the drive backplane cover](#).
4. If installed, [remove the air shroud](#).
5. [Remove the cooling fan assembly](#).
6. [Remove the side wall bracket](#).

Steps

1. Disconnect the control panel cable from the connector on the system board.
2. Using the Phillips #1 screwdriver, remove the screws that secure the left control panel and the left control panels cable cover to the system.
3. Hold the left control panel cable, and slide the left control panel out of the system.

NOTE: Observe the routing of the cable as you remove the right control panel from the system.

NOTE: The numbers on the image do not depict the exact steps. The numbers are for representation of sequence.

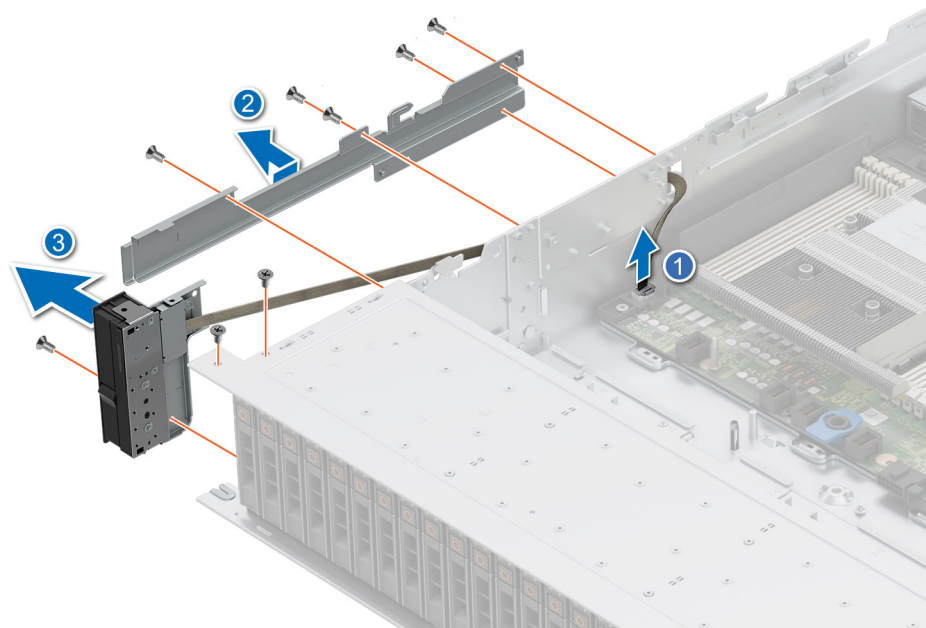

Figure 203. Removing the left control panel

Next steps

1. [Replace the left control panel.](#)

Installing the left control panel

Prerequisites

1. Follow the safety guidelines listed in the [Safety instructions](#).
2. Follow the procedure listed in [Before working inside your system](#).

Steps

1. Align and slide the left control panel in the slot on the system.
2. Connect the left control panel cable to the connector on the system board .
3. Route the left control panel cable through the side wall of the system. Align and slide the left control panel cable cover in the slot on the system.

NOTE: Route the cable properly to prevent the cable from being pinched or crimped.

4. Using the Phillips #1 screwdriver, tighten the screws to secure the left control panel and the left control panel cable cover to the system.

NOTE: The numbers on the image do not depict the exact steps. The numbers are for representation of sequence.

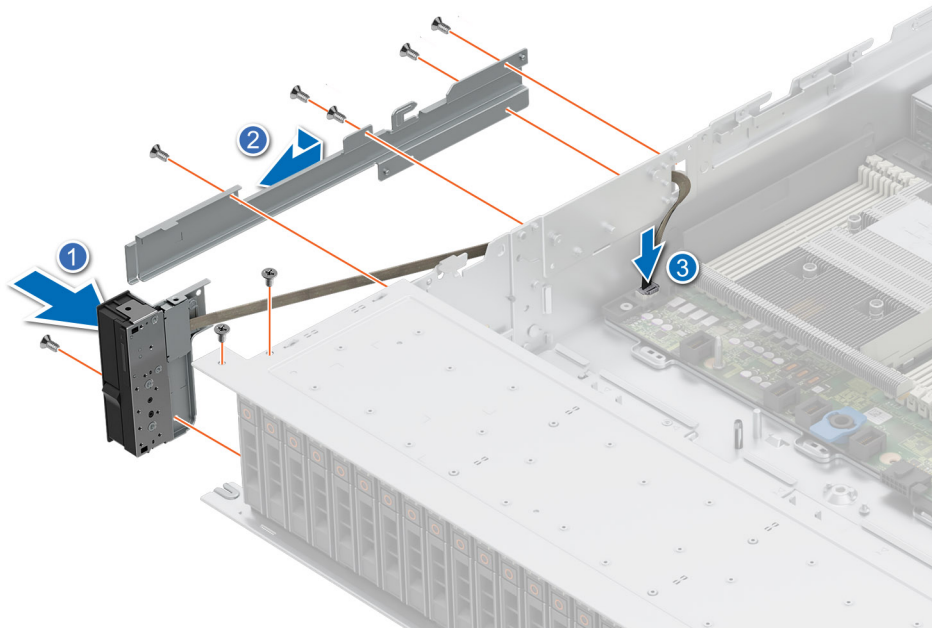

Figure 204. Installing the left control panel

Next steps

1. [Install the side wall bracket.](#)
2. [Install the cooling fan assembly.](#)
3. [Install the drive backplane cover.](#)
4. If removed, [install the air shroud.](#)
5. Follow the procedure listed in [After working inside your system.](#)

Jumpers and connectors

This section provides essential and specific information about jumpers and switches. It also describes the connectors on the various boards in the system. Jumpers on the system board help to disable the system and reset the passwords. To install components and cables correctly, you must be able to identify the connectors on the system board.

Topics:

- System board connectors
- System board jumper settings
- Disabling a forgotten password

System board connectors

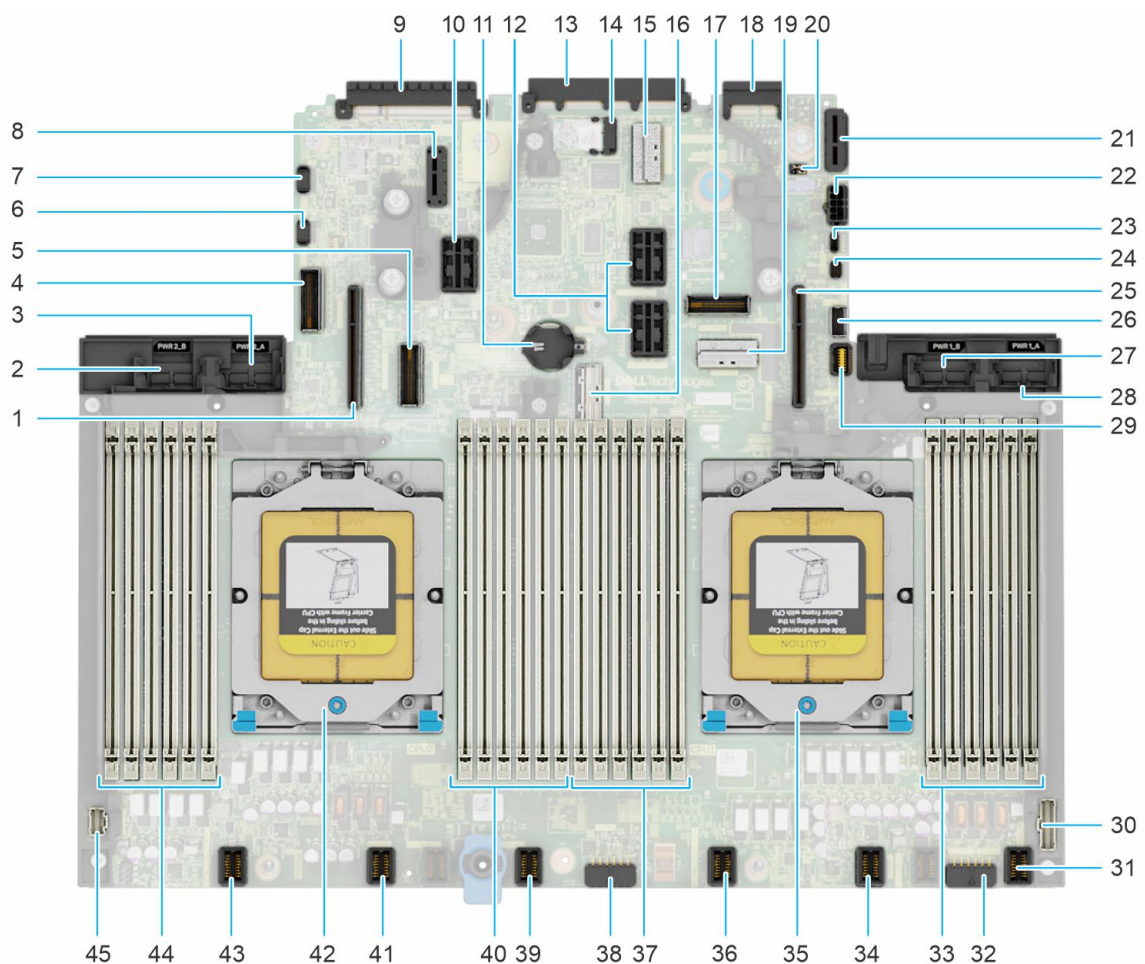

Figure 205. System board jumpers and connectors

Table 124. System board jumpers and connectors

Item	Connector	Description
1.	IO_RISER4 (CPU2)	Riser 4

Table 124. System board jumpers and connectors (continued)

Item	Connector	Description
2.	PWR 2_B	Power Connector for PSU2
3.	PWR 2_A	Power Connector for PSU2
4.	SL1_CPU2_PA4	PCIe Connector 1
5.	SL2_CPU2_PB4	PCIe Connector 2
6.	PSU2 PUCK Sideband Signal	PSU2 PUCK Sideband Signal
7.	Battery SIG Connector	Battery SIG Connector
8.	J_R3_PCIE_PWR	Riser 3 Power Connector
9.	Rear I/O connector	Rear I/O Connector
10.	IO_RISER3 (CPU2)	Riser 3
11.	Coin Cell Battery	Coin Cell Battery
12.	IO_RISER2_A (CPU1) IO_RISER2_B (CPU2)	Riser 2
13.	OCP NIC 3.0 connector	OCP NIC 3.0 Connector
14.	J_TPM	TPM
15.	DSL_CPU1_PB2	PCIe Connector
16.	SL3_CPU1_PA1	PCIe Connector 3
17.	SL5_CPU1_PB2	PCIe Connector 5
18.	LOM connector	LOM Connector
19.	SL4_CPU1_PB1	PCIe Connector 4
20.	Jumpers	Jumpers
21.	IDSDM/Internal USB connector	IDSDM/Internal USB Connector
22.	Power Connector 0 - Use for Rear BP	Power Connector 0 - Use for Rear BP
23.	BOSS_CARD_PWR	BOSS Card Power
24.	PSU1 PUCK Sideband Signal	PSU1 PUCK Sideband Signal
25.	IO_RISER1 (CPU1)	Riser 1
26.	SL6_CPU1_PA3	PCIe Connector 6
27.	PWR 1_B	Power Connector for PSU1
28.	PWR 1_A	Power Connector for PSU1
29.	MB_FRONT_VIDEO	Front VGA Connector
30.	RGT_CP	Right Control Panel Connector
31.	FAN 6	Fan 6
32.	PWR Connector 2 - Use for BP only	Power Connector 2 - Use for BP only
33.	A2, A6, A4, A10, A8, A12	DIMMs for processor 1 channels G,H, I, J, K, L
34.	FAN 5	Fan 5
35.	CPU1	Processor 1
36.	FAN 4	Fan 4





Table 124. System board jumpers and connectors (continued)

Item	Connector	Description
37.	A11, A7, A9, A3, A5, A1	DIMMs for processor 1 channels F, E, D, C, B, A
38.	PWR Connector 1 - Use for BP only	Power Connector 1 - Use for BP only
39.	FAN 3	Fan 3
40.	B2, B6, B4, B10, B8, B12	DIMMs for processor 2 channels G, H, I, J, K, L
41.	FAN 2	Fan 2
42.	CPU2	Processor 2
43.	FAN 1	Fan 1
44.	B11, B7, B9, B3, B5, B1	DIMMs for processor 2 channels F, E, D, C, B, A
45.	LFT_CP	Left Control Panel Connector

System board jumper settings

For information about resetting the password jumper to disable a password, see the [Disabling a forgotten password](#) section.

Table 125. System board jumper settings

Jumper	Setting	Description
PWRD_EN	 2 4 6 (default)	The BIOS password feature is enabled.
	 2 4 6	The BIOS password feature is disabled. The BIOS password is now disabled and you are not allowed to set a new password.
NVRAM_CLR	 1 3 5 (default)	The BIOS configuration settings are retained at system boot.
	 1 3 5	The BIOS configuration settings are cleared at system boot.

CAUTION: Be careful when changing the BIOS settings. The BIOS interface is designed for advanced users. Any change in the setting could prevent your system from starting correctly and you might have potential loss of data.

Disabling a forgotten password

The software security features of the system include a system password and a setup password. The password jumper enables or disables password features and clears any password(s) currently in use.

Prerequisites

CAUTION: Many repairs may only be done by a certified service technician. You should only perform troubleshooting and simple repairs as authorized in your product documentation, or as directed by the online or telephone service and support team. Damage due to servicing that is not authorized by Dell is not covered by your warranty. Read and follow the safety instructions that are shipped with your product.

Steps

1. Power off the system, and all the attached peripherals, and disconnect the system from the electrical outlet.

2. Remove the system cover.
3. Move the jumper on the system board from pins 2 and 4 to pins 4 and 6.
4. Replace the system cover.

i **NOTE:** The existing passwords are not disabled (erased) until the system boots with the jumper on pins 4 and 6. However, before you assign a new system and/or setup password, you must move the jumper back to pins 2 and 4.

i **NOTE:** If you assign a new system and/or setup password with the jumper on pins 4 and 6, the system disables the new password(s) the next time it boots.

5. Reconnect the system and all the attached peripherals.
6. Power off the system.
7. Remove the system cover.
8. Move the jumper on the system board from pins 4 and 6 to pins 2 and 4.
9. Replace the system cover.
10. Reconnect the system to the electrical outlet and power on the system, and all the attached peripherals.
11. Assign a new system and/or setup password.

System diagnostics and indicator codes

This section describes the diagnostic indicators on the system front panel that displays the system status during system startup.

Topics:

- [Status LED indicators](#)
- [System health and system ID indicator codes](#)
- [iDRAC Quick Sync 2 indicator codes](#)
- [iDRAC Direct LED indicator codes](#)
- [LCD panel](#)
- [NIC indicator codes](#)
- [Power supply unit indicator codes](#)
- [Drive indicator codes](#)

Status LED indicators

 **NOTE:** The indicators display solid amber if any error occurs.

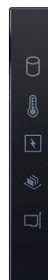

Figure 206. Status LED indicators

Table 126. Status LED indicators and descriptions





Icon	Description	Condition	Corrective action
	Drive indicator	The indicator turns solid amber if there is a drive error.	<ul style="list-style-type: none"> • Check the System Event Log to determine if the drive has an error. • Run the appropriate Online Diagnostics test. Restart the system and run embedded diagnostics (ePSA). • If the drives are configured in a RAID array, restart the system, and enter the host adapter configuration utility program.
	Temperature indicator	The indicator turns solid amber if the system experiences a thermal error (for example, the ambient	Ensure that none of the following conditions exist: <ul style="list-style-type: none"> • A cooling fan has been removed or has failed.

Table 126. Status LED indicators and descriptions (continued)

Icon	Description	Condition	Corrective action
		temperature is out of range or there is a fan failure).	<ul style="list-style-type: none"> • System cover, air shroud, or back filler bracket is removed. • Ambient temperature is too high. • External airflow is obstructed. <p>If the problem persists, see the Getting help section.</p>
	Electrical indicator	The indicator turns solid amber if the system experiences an electrical error (for example, voltage out of range, or a failed power supply unit (PSU) or voltage regulator).	<p>Check the System Event Log or system messages for the specific issue. If it is due to a problem with the PSU, check the LED on the PSU. Reseat the PSU.</p> <p>If the problem persists, see the Getting help section.</p>
	Memory indicator	The indicator turns solid amber if a memory error occurs.	<p>Check the System Event Log or system messages for the location of the failed memory. Reseat the memory module.</p> <p>If the problem persists, see the Getting help section.</p>
	PCIe indicator	The indicator turns solid amber if a PCIe card experiences an error.	<p>Restart the system. Update any required drivers for the PCIe card. Reinstall the card.</p> <p>If the problem persists, see the Getting help section.</p> <p>NOTE: For more information about the supported PCIe cards, see the Expansion card installation guidelines section.</p>

System health and system ID indicator codes

The system health and system ID indicator is located on the left control panel of the system.



Figure 207. System health and system ID indicator

Table 127. System health and system ID indicator codes

System health and system ID indicator code	Condition
Solid blue	Indicates that the system is powered on, is healthy, and system ID mode is not active. Press the system health and system ID button to switch to system ID mode.
Blinking blue	Indicates that the system ID mode is active. Press the system health and system ID button to switch to system health mode.
Solid amber	Indicates that the system is in fail-safe mode.If the problem persists, see the Getting help section.
Blinking amber	Indicates that the system is experiencing a fault. Check the System Event Log for specific error messages. For information about the event and error messages generated by the system firmware and agents that monitor system components, go to qrl.dell.com > Look Up > Error Code , type the error code, and then click Look it up .

iDRAC Quick Sync 2 indicator codes

iDRAC Quick Sync 2 module (optional) is located on the left control panel of the system.



Table 128. iDRAC Quick Sync 2 indicators and descriptions

iDRAC Quick Sync 2 indicator code	Condition	Corrective action
Off (default state)	Indicates that the iDRAC Quick Sync 2 feature is powered off. Press the iDRAC Quick Sync 2 button to power on the iDRAC Quick Sync 2 feature.	If the LED fails to power on, reseal the left control panel flex cable and check. If the problem persists, see the Getting help section.
Solid white	Indicates that iDRAC Quick Sync 2 is ready to communicate. Press the iDRAC Quick Sync 2 button to power off.	If the LED fails to power off, restart the system. If the problem persists, see the Getting help section.
Blinks white rapidly	Indicates data transfer activity.	If the indicator continues to blink indefinitely, see the Getting help section.
Blinks white slowly	Indicates that firmware update is in progress.	If the indicator continues to blink indefinitely, see the Getting help section.
Blinks white five times rapidly and then powers off	Indicates that the iDRAC Quick Sync 2 feature is disabled.	Check if iDRAC Quick Sync 2 feature is configured to be disabled by iDRAC. If the problem persists, see the Getting help section. www.dell.com/poweredgemanuals or <i>Dell OpenManage Server Administrator User's Guide</i> at www.dell.com/openmanagemanuals .
Solid amber	Indicates that the system is in fail-safe mode.	Restart the system. If the problem persists, see the Getting help section.
Blinking amber	Indicates that the iDRAC Quick Sync 2 hardware is not responding properly.	Restart the system. If the problem persists, see the Getting help section.

iDRAC Direct LED indicator codes

The iDRAC Direct LED indicator lights up to indicate that the port is connected and is being used as a part of the iDRAC subsystem.

You can configure iDRAC Direct by using a USB to micro USB (type AB) cable, which you can connect to your laptop or tablet. Cable length should not exceed 3 feet (0.91 meters). Performance could be affected by cable quality. The following table describes iDRAC Direct activity when the iDRAC Direct port is active:

Table 129. iDRAC Direct LED indicator codes

iDRAC Direct LED indicator code	Condition
Solid green for two seconds	Indicates that the laptop or tablet is connected.
Blinking green (on for two seconds and off for two seconds)	Indicates that the laptop or tablet connected is recognized.
Powers off	Indicates that the laptop or tablet is unplugged.

LCD panel

The LCD panel provides system information, status, and error messages to indicate if the system is functioning correctly or requires attention. The LCD panel is used to configure or view the iDRAC IP address of the system. For information about the event and error messages generated by the system firmware and agents that monitor system components, go to qrl.dell.com >

Look Up > Error Code, type the error code, and then click **Look it up..**

The LCD panel is available only on the optional front bezel. The optional front bezel is hot pluggable.

The status and conditions of the LCD panel are outlined here:

- The LCD backlight is white during normal operating conditions.
- If there is an issue, the LCD backlight turns amber and displays an error code followed by descriptive text.
- **NOTE:** If the system is connected to a power source and an error is detected, the LCD turns amber regardless of whether the system is powered on or off.
- When the system powers off and there are no errors, the LCD enters the standby mode after five minutes of inactivity. Press any button on the LCD to power it on.
- If the LCD panel stops responding, remove the bezel and reinstall it.
If the problem persists, see [Getting help](#).
- The LCD backlight remains off if LCD messaging is powered off using the iDRAC utility, the LCD panel, or other tools.

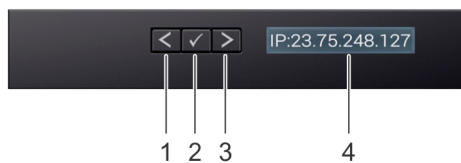

Figure 208. LCD panel features

Table 130. LCD panel features

Item	Button or display	Description
1	Left	Moves the cursor back in one-step increments.
2	Select	Selects the menu item highlighted by the cursor.
3	Right	Moves the cursor forward in one-step increments. During message scrolling:

Table 130. LCD panel features (continued)

Item	Button or display	Description
		<ul style="list-style-type: none"> Press and hold the right button to increase scrolling speed. Release the button to stop. <p>NOTE: The display stops scrolling when the button is released. After 45 seconds of inactivity, the display starts scrolling.</p>
4	LCD display	Displays the system information, status, and error messages or iDRAC IP address.

NIC indicator codes

Each NIC on the back of the system has indicators that provide information about the activity and link status. The activity LED indicator indicates if data is flowing through the NIC, and the link LED indicator indicates the speed of the connected network.

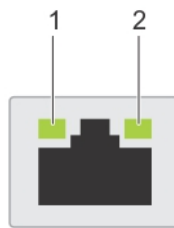

Figure 209. NIC indicator codes

1. Link LED indicator
2. Activity LED indicator

Table 131. NIC indicator codes

NIC indicator codes	Condition
Link and activity indicators are off.	Indicates that the NIC is not connected to the network.
Link indicator is green, and activity indicator is blinking green.	Indicates that the NIC is connected to a valid network at its maximum port speed, and data is being sent or received.
Link indicator is amber, and activity indicator is blinking green.	Indicates that the NIC is connected to a valid network at less than its maximum port speed, and data is being sent or received.
Link indicator is green, and activity indicator is off.	Indicates that the NIC is connected to a valid network at its maximum port speed, and data is not being sent or received.
Link indicator is amber, and activity indicator is off.	Indicates that the NIC is connected to a valid network at less than its maximum port speed, and data is not being sent or received.
Link indicator is blinking green, and activity is off.	Indicates that the NIC identify is enabled through the NIC configuration utility.

Power supply unit indicator codes

AC and DC power supply units (PSUs) have an illuminated translucent handle that serves as an indicator. The indicator shows if power is present or if a power fault has occurred.

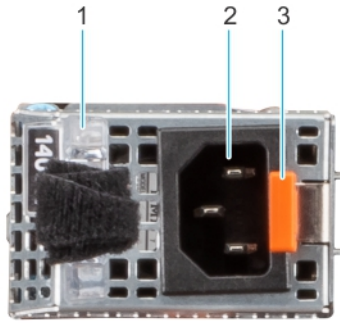

Figure 210. AC PSU status indicator

1. AC PSU handle
2. Socket
3. Release latch

Table 132. AC and DC PSU status indicator codes

Power indicator codes	Condition
Green	Indicates that a valid power source is connected to the PSU and the PSU is operational.
Blinking amber	Indicates an issue with the PSU.
Not powered on	Indicates that the power is not connected to the PSU.
Blinking green	<p>Indicates that the firmware of the PSU is being updated.</p> <p>⚠ CAUTION: Do not disconnect the power cord or unplug the PSU when updating firmware. If firmware update is interrupted, the PSUs will not function.</p>
Blinking green and powers off	<p>When hot-plugging a PSU, it blinks green five times at a rate of 4 Hz and powers off. This indicates a PSU mismatch due to efficiency, feature set, health status, or supported voltage.</p> <p>⚠ CAUTION: If two PSUs are installed, both the PSUs must have the same type of label; for example, Extended Power Performance (EPP) label. Mixing PSUs from previous generations of PowerEdge servers is not supported, even if the PSUs have the same power rating. This results in a PSU mismatch condition or failure to power on the system.</p> <p>⚠ CAUTION: If two PSUs are used, they must be of the same type and have the same maximum output power.</p> <p>⚠ CAUTION: When correcting a PSU mismatch, replace the PSU with the blinking indicator. Swapping the PSU to make a matched pair can result in an error condition and an unexpected system shutdown. To change from a high output configuration to a low output configuration or vice versa, you must power off the system.</p> <p>⚠ CAUTION: AC PSUs support both 240 V and 120 V input voltages with the exception of Titanium PSUs, which support only 240 V. When two identical PSUs receive different input voltages, they can output different wattages, and trigger a mismatch.</p>

Drive indicator codes

The LEDs on the drive carrier indicates the state of each drive. Each drive carrier has two LEDs: an activity LED (green) and a status LED (bicolor, green/amber). The activity LED blinks whenever the drive is accessed.



Figure 211. Drive indicators

- 1. Drive activity LED indicator
- 2. Drive status LED indicator
- 3. Drive capacity label

NOTE: If the drive is in the Advanced Host Controller Interface (AHCI) mode, the status LED indicator does not power on.

NOTE: Drive status indicator behavior is managed by Storage Spaces Direct. Not all drive status indicators may be used.

Table 133. Drive indicator codes

Drive status indicator code	Condition
Blinks green twice per second	Indicates that the drive is being identified or preparing for removal.
Not powered on	Indicates that the drive is ready for removal. NOTE: The drive status indicator remains off until all drives are initialized after the system is powered on. Drives are not ready for removal during this time.
Blinks green, amber, and then powers off	Indicates that there is an expected drive failure.
Blinks amber four times per second	Indicates that the drive has failed.
Blinks green slowly	Indicates that the drive is rebuilding.
Solid green	Indicates that the drive is online.
Blinks green for three seconds, amber for three seconds, and then powers off after six seconds	Indicates that the rebuild has stopped.

Using system diagnostics

If you experience an issue with the system, run the system diagnostics before contacting Dell for technical assistance. The purpose of running system diagnostics is to test the system hardware without using additional equipment or risking data loss. If you are unable to fix the issue yourself, service and support personnel can use the diagnostics results to help you solve the issue.

Topics:

- [Dell Embedded System Diagnostics](#)

Dell Embedded System Diagnostics

NOTE: The Dell Embedded System Diagnostics is also known as Enhanced Pre-boot System Assessment (ePSA) diagnostics.

The Embedded System Diagnostics provide a set of options for particular device groups or devices allowing you to:

- Run tests automatically or in an interactive mode
- Repeat tests
- Display or save test results
- Run thorough tests to introduce additional test options to provide extra information about the failed device(s)
- View status messages that inform you if tests are completed successfully
- View error messages that inform you of issues encountered during testing

Running the Embedded System Diagnostics from Boot Manager

Run the Embedded System Diagnostics (ePSA) if your system does not boot.

Steps

1. When the system is booting, press F11.
2. Use the up arrow and down arrow keys to select **System Utilities > Launch Diagnostics**.
3. Alternatively, when the system is booting, press F10, select **Hardware Diagnostics > Run Hardware Diagnostics**. The **ePSA Pre-boot System Assessment** window is displayed, listing all devices detected in the system. The diagnostics starts executing the tests on all the detected devices.

Running the Embedded System Diagnostics from the Dell Lifecycle Controller

Steps

1. When the system is booting, press F10.
2. Select **Hardware Diagnostics → Run Hardware Diagnostics**. The **ePSA Pre-boot System Assessment** window is displayed, listing all devices detected in the system. The diagnostics start executing the tests on all the detected devices.

System diagnostic controls

Table 134. System diagnostic controls

Menu	Description
Configuration	Displays the configuration and status information of all detected devices.
Results	Displays the results of all tests that are run.
System health	Provides the current overview of the system performance.
Event log	Displays a time-stamped log of the results of all tests run on the system. This is displayed if at least one event description is recorded.

System board diagnostic LED indicators

The system board LED indicators provide status of the system when it is powered on, which help identify POST and hardware issues.

For information about the different LED indicator sequences and description, see the interactive **LED pattern decoder tool** -<https://internal.software/blink/>.

Enhanced Preboot System Assessment

If you experience an issue with the system, run the system diagnostics before contacting Dell for technical assistance. The purpose of running system diagnostics is to test the system hardware without requiring more equipment or risking data loss. If you are unable to fix the issue yourself, service and support personnel can use the diagnostics results to help you solve the issue.

Dell Embedded system diagnostics

NOTE: The Dell Embedded System Diagnostics is also known as Enhanced Preboot System Assessment (ePSA) diagnostics.

The embedded system diagnostics provides a set of options for particular device groups or devices that allow you to:

- Run tests automatically or in an interactive mode.
- Repeat tests
- Display or save test results.
- Introduce more test options for extra information about the failed devices, run a thorough test.
- View status messages that inform you if tests are completed successfully.
- View error messages that inform you of issues encountered during testing.

Running the Embedded system diagnostics from Boot Manager

To run the embedded system diagnostics from Boot Manager:

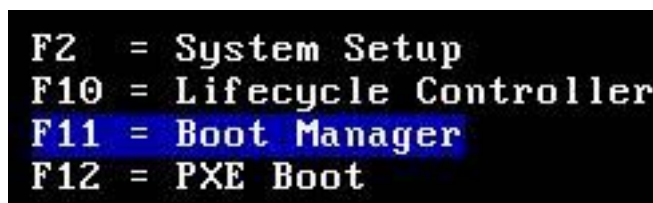

1. As the system boots, press <F11>.
2. Using the arrow keys select **System Utilities** → **Launch Diagnostics**.

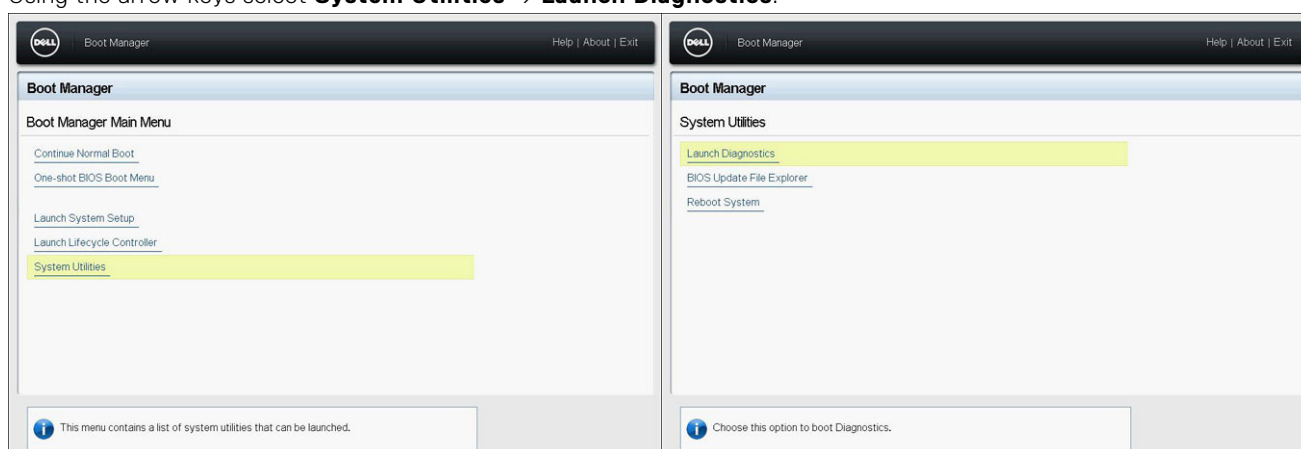

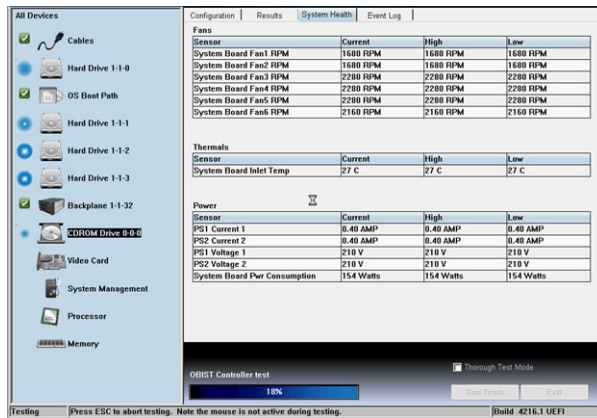

3. Wait while the Quick Tests automatically run.
4. Once the tests have been completed, you can view the results and additional information on the **Results** tab, the **System Health** tab, the **Configuration** tab, and the **Event Log** tab.
5. Close the **Embedded System Diagnostics** utility.
6. To leave the diagnostics, click **Exit**.
7. Click **OK** when prompted, and the system reboots.

Running the Embedded System Diagnostics from the Dell Lifecycle Controller

To run the embedded system diagnostics from the Dell Lifecycle Controller:

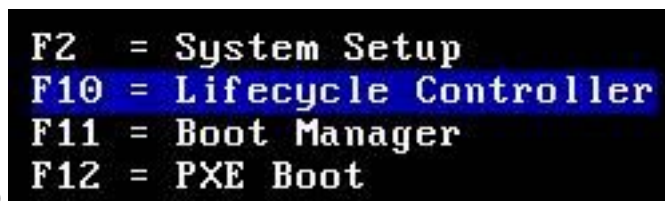

1. As the system boots, press **F10**.

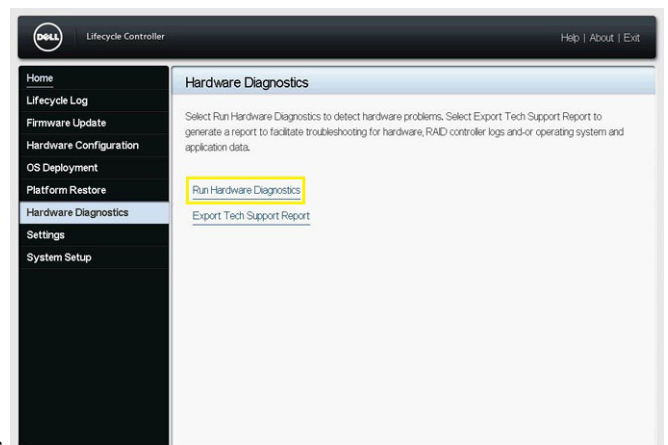

2. Select **Hardware Diagnostics** → **Run Hardware Diagnostics**.

Getting help

You can download drivers, firmware and documents from the FTP site: <https://mft.dell.com/R7625>. For more information about username and password, contact your TAM (Tech Account Manager).

The QRL, SupportAssist/ Secure Connect Gateway, and eSupport sites will be launched in Quarter 4 of the calendar year 2022.

Topics:

- [Recycling or End-of-Life service information](#)
- [Contacting Dell Technologies](#)
- [Accessing system information by using QRL](#)
- [Receiving automated support with SupportAssist](#)

Recycling or End-of-Life service information

Take back and recycling services are offered for this product in certain countries. If you want to dispose of system components, visit www.dell.com/recyclingworldwide and select the relevant country.

Contacting Dell Technologies

Dell provides online and telephone based support and service options. If you do not have an active internet connection, you can find Dell contact information on your purchase invoice, packing slip, bill or Dell product catalog. The availability of services varies depending on the country and product, and some services may not be available in your area. To contact Dell for sales, technical assistance, or customer service issues follow these steps:

Steps

1. Go to www.dell.com/support/home.
2. Select your country from the drop-down menu on the lower right corner of the page.
3. For customized support:
 - a. Enter the system Service Tag in the **Enter a Service Tag, Serial Number, Service Request, Model, or Keyword** field.
 - b. Click **Search**.
The support page that lists the various support categories is displayed.
4. For general support:
 - a. Select your product category.
 - b. Select your product segment.
 - c. Select your product.
The support page that lists the various support categories is displayed.
5. For contact details of Dell Global Technical Support:
 - a. Click [Contact Technical Support](#).
 - b. The **Contact Technical Support** page is displayed with details to call, chat, or e-mail the Dell Global Technical Support team.

Accessing system information by using QRL

You can use the Quick Resource Locator (QRL) located on the information tag in the front of the R7625 system, to access information about PowerEdge R7625. There is also another QRL for accessing product information located on the back of the system cover.

Prerequisites

Ensure that your smartphone or tablet has a QR code scanner installed.

The QRL includes the following information about your system:

- How-to videos
- Reference materials, including the Installation and Service Manual, and mechanical overview
- The system service tag to quickly access the specific hardware configuration and warranty information
- A direct link to Dell to contact technical assistance and sales teams

Steps

1. Go to www.dell.com/qrl, and navigate to your specific product or
2. Use your smart phone or tablet to scan the model-specific Quick Resource (QR) code on your system or in the Quick Resource Locator section.

Quick Resource Locator for PowerEdge R7625 system



Figure 212. Quick Resource Locator for PowerEdge R7625 system

Receiving automated support with SupportAssist

Dell SupportAssist is an optional Dell Services offering that automates technical support for your Dell server, storage, and networking devices. By installing and setting up a SupportAssist application in your IT environment, you can receive the following benefits:

- Automated issue detection — SupportAssist monitors your Dell devices and automatically detects hardware issues, both proactively and predictively.
- Automated case creation — When an issue is detected, SupportAssist automatically opens a support case with Dell Technical Support.
- Automated diagnostic collection — SupportAssist automatically collects system state information from your devices and uploads it securely to Dell. This information is used by Dell Technical Support to troubleshoot the issue.
- Proactive contact — A Dell Technical Support agent contacts you about the support case and helps you resolve the issue.

The available benefits vary depending on the Dell Service entitlement purchased for your device. For more information about SupportAssist, go to www.dell.com/supportassist.

Documentation resources

This section provides information about the documentation resources for your system.

To view the document that is listed in the documentation resources table:

- From the Dell support site:
 1. Click the documentation link that is provided in the Location column in the table.
 2. Click the required product or product version.
-  **NOTE:** To locate the model number, see the front of your system.
- 3. On the Product Support page, click **Documentation**.
- Using search engines:
 - Type the name and version of the document in the search box.

Table 135. Additional documentation resources for your system

Task	Document	Location
Setting up your system	<p>For more information about installing and securing the system into a rack, see the Rail Installation Guide included with your rail solution.</p> <p>For information about setting up your system, see the <i>Getting Started Guide</i> document that is shipped with your system.</p>	www.dell.com/poweredgemanuals
Configuring your system	<p>For information about the iDRAC features, configuring and logging in to iDRAC, and managing your system remotely, see the Integrated Dell Remote Access Controller User's Guide.</p> <p>For information about understanding Remote Access Controller Admin (RACADM) subcommands and supported RACADM interfaces, see the RACADM CLI Guide for iDRAC.</p> <p>For information about Redfish and its protocol, supported schema, and Redfish Eventing implemented in iDRAC, see the Redfish API Guide.</p> <p>For information about iDRAC property database group and object descriptions, see the Attribute Registry Guide.</p> <p>For information about Intel QuickAssist Technology, see the Integrated Dell Remote Access Controller User's Guide.</p>	www.dell.com/poweredgemanuals
	<p>For information about earlier versions of the iDRAC documents.</p> <p>To identify the version of iDRAC available on your system, on the iDRAC web interface, click ? > About.</p>	www.dell.com/idracmanuals

Table 135. Additional documentation resources for your system (continued)

Task	Document	Location
	For information about installing the operating system, see the operating system documentation.	www.dell.com/operatingsystemmanuals
	For information about updating drivers and firmware, see the Methods to download firmware and drivers section in this document.	www.dell.com/support/drivers
Managing your system	For information about systems management software offered by Dell, see the Dell OpenManage Systems Management Overview Guide.	www.dell.com/poweredgemanuals
	For information about setting up, using, and troubleshooting OpenManage, see the Dell OpenManage Server Administrator User's Guide.	www.dell.com/openmanagemanuals > OpenManage Server Administrator
	For information about installing and using Dell SupportAssist, see the Dell SupportAssist Enterprise User's Guide.	https://www.dell.com/serviceabilitytools
	For information about partner programs enterprise systems management, see the OpenManage Connections Enterprise Systems Management documents.	www.dell.com/openmanagemanuals
Working with the Dell PowerEdge RAID controllers	For information about understanding the features of the Dell PowerEdge RAID controllers (PERC), Software RAID controllers, or BOSS card and deploying the cards, see the Storage controller documentation.	www.dell.com/storagecontrollermanuals
Understanding event and error messages	For information about the event and error messages generated by the system firmware and agents that monitor system components, go to qrl.dell.com > Look Up > Error Code , type the error code, and then click Look it up .	www.dell.com/qrl
Troubleshooting your system	For information about identifying and troubleshooting the PowerEdge server issues, see the Server Troubleshooting Guide.	www.dell.com/poweredgemanuals

Documentation resources

This section provides information about the documentation resources for your system.

To view the document that is listed in the documentation resources table:

- From the Dell support site:
 1. Click the documentation link that is provided in the Location column in the table.
 2. Click the required product or product version.
-  **NOTE:** To locate the model number, see the front of your system.
- 3. On the Product Support page, click **Documentation**.
- Using search engines:
 - Type the name and version of the document in the search box.

Table 136. Additional documentation resources for your system

Task	Document	Location
Setting up your system	<p>For more information about installing and securing the system into a rack, see the Rail Installation Guide included with your rail solution.</p> <p>For information about setting up your system, see the <i>Getting Started Guide</i> document that is shipped with your system.</p>	www.dell.com/poweredgemanuals
Configuring your system	<p>For information about the iDRAC features, configuring and logging in to iDRAC, and managing your system remotely, see the Integrated Dell Remote Access Controller User's Guide.</p> <p>For information about understanding Remote Access Controller Admin (RACADM) subcommands and supported RACADM interfaces, see the RACADM CLI Guide for iDRAC.</p> <p>For information about Redfish and its protocol, supported schema, and Redfish Eventing implemented in iDRAC, see the Redfish API Guide.</p> <p>For information about iDRAC property database group and object descriptions, see the Attribute Registry Guide.</p> <p>For information about Intel QuickAssist Technology, see the Integrated Dell Remote Access Controller User's Guide.</p>	www.dell.com/poweredgemanuals
	<p>For information about earlier versions of the iDRAC documents.</p> <p>To identify the version of iDRAC available on your system, on the iDRAC web interface, click ? > About.</p>	www.dell.com/idracmanuals

Table 136. Additional documentation resources for your system (continued)

Task	Document	Location
	For information about installing the operating system, see the operating system documentation.	www.dell.com/operatingsystemmanuals
	For information about updating drivers and firmware, see the Methods to download firmware and drivers section in this document.	www.dell.com/support/drivers
Managing your system	For information about systems management software offered by Dell, see the Dell OpenManage Systems Management Overview Guide.	www.dell.com/poweredgemanuals
	For information about setting up, using, and troubleshooting OpenManage, see the Dell OpenManage Server Administrator User's Guide.	www.dell.com/openmanagemanuals > OpenManage Server Administrator
	For information about installing and using Dell SupportAssist, see the Dell SupportAssist Enterprise User's Guide.	https://www.dell.com/serviceabilitytools
	For information about partner programs enterprise systems management, see the OpenManage Connections Enterprise Systems Management documents.	www.dell.com/openmanagemanuals
Working with the Dell PowerEdge RAID controllers	For information about understanding the features of the Dell PowerEdge RAID controllers (PERC), Software RAID controllers, or BOSS card and deploying the cards, see the Storage controller documentation.	www.dell.com/storagecontrollermanuals
Understanding event and error messages	For information about the event and error messages generated by the system firmware and agents that monitor system components, go to qrl.dell.com > Look Up > Error Code , type the error code, and then click Look it up .	www.dell.com/qrl
Troubleshooting your system	For information about identifying and troubleshooting the PowerEdge server issues, see the Server Troubleshooting Guide.	www.dell.com/poweredgemanuals