

Dell PowerEdge R960

Installation and Service Manual

Notes, cautions, and warnings

 **NOTE:** A NOTE indicates important information that helps you make better use of your product.

 **CAUTION:** A CAUTION indicates either potential damage to hardware or loss of data and tells you how to avoid the problem.

 **WARNING:** A WARNING indicates a potential for property damage, personal injury, or death.

Chapter 1: About this document	8
Chapter 2: Dell PowerEdge R960 system overview	9
Front view of the system.....	10
Left control panel view.....	13
Right control panel view.....	14
Rear view of the system.....	15
Inside the system.....	17
Locating the Express Service Code and Service Tag.....	20
System information labels.....	21
Rail sizing and rack compatibility matrix.....	25
Chapter 3: Technical specifications	26
Chassis dimensions	27
System weight.....	27
Processor specifications.....	28
PSU specifications.....	28
Cooling fan specifications.....	29
Supported operating systems.....	30
System battery specifications.....	30
Expansion card riser specifications.....	30
Memory specifications.....	31
Storage controller specifications.....	32
Drives.....	32
Ports and connectors specifications.....	33
USB ports specifications.....	33
NIC port specifications.....	33
Serial connector specifications.....	33
VGA ports specifications.....	33
Video specifications.....	33
Environmental specifications.....	34
Thermal restriction matrix.....	36
Thermal air restrictions.....	38
Chapter 4: Initial system setup and configuration	39
Setting up the system.....	39
iDRAC configuration.....	39
Options to set up iDRAC IP address.....	39
Options to log in to iDRAC.....	40
Resources to install operating system.....	41
Options to download drivers and firmware	41
Options to download and install OS drivers	42
Downloading drivers and firmware.....	42

Chapter 5: Pre-operating system management applications.....	43
System Setup.....	43
System BIOS.....	44
iDRAC Settings.....	64
Device Settings.....	65
Service Tag Settings.....	65
Dell Lifecycle Controller.....	65
Embedded system management.....	65
Boot Manager.....	65
PXE boot.....	65
Chapter 6: Minimum to POST and system management configuration validation.....	66
Minimum configuration to POST	66
Configuration validation.....	66
Error messages.....	67
Chapter 7: Installing and removing system components	68
Safety instructions.....	68
Before working inside your system	69
After working inside your system.....	69
Recommended tools.....	69
Optional front bezel.....	70
Removing the front bezel.....	70
Installing the front bezel.....	71
System cover.....	71
Removing the system cover.....	71
Installing the system cover.....	72
Support bar.....	73
Removing the support bar.....	73
Installing the support bar.....	75
Cooling fans.....	76
Removing the cooling fan cage assembly	76
Installing the cooling fan cage assembly.....	77
Removing a cooling fan.....	78
Installing a cooling fan.....	79
Air shrouds.....	80
Removing the air shroud top cover.....	80
Installing the air shroud top cover.....	80
Removing the air shroud.....	81
Installing the air shroud.....	82
Removing the GPU air shroud.....	83
Installing the GPU air shroud.....	84
Removing the riser air shroud.....	85
Installing the riser air shroud.....	86
Drives.....	87
Removing a drive blank.....	87
Installing a drive blank.....	88
Removing a drive carrier.....	88

Installing the drive carrier.....	89
Removing the drive from the drive carrier.....	90
Installing the drive into the drive carrier.....	91
Removing an EDSFF E3.S drive blank.....	92
Installing an EDSFF E3.S drive blank.....	93
Removing an EDSFF E3.S drive carrier.....	94
Installing an EDSFF E3.S drive carrier.....	95
Removing an EDSFF E3.S drive from the drive carrier.....	96
Installing an EDSFF E3.S drive into the drive carrier.....	97
Drive backplane.....	98
Drive backplane.....	98
Removing the drive backplane	100
Installing the drive backplane.....	101
Side wall brackets.....	102
Removing the side wall bracket.....	102
Installing the side wall bracket.....	103
Cable routings.....	105
PERC module.....	119
Removing the rear mounting front PERC module.....	119
Installing the rear mounting front PERC module.....	119
EDSFF E3.S backplane module.....	120
Removing the EDSFF E3.S backplane module.....	120
Installing the EDSFF E3.S backplane module.....	121
System memory.....	123
System memory guidelines.....	123
General memory module installation guidelines.....	125
Removing a memory module.....	126
Installing a memory module.....	127
Expansion cards and expansion card risers.....	128
Expansion card installation guidelines.....	128
Removing the expansion card risers.....	143
Installing the expansion card risers.....	147
Removing expansion card from the expansion card riser.....	151
Installing an expansion card into the expansion card riser.....	153
Removing the full length expansion card risers.....	154
Installing the full length expansion card risers.....	156
Removing a GPU.....	158
Installing a GPU.....	160
Power distribution board.....	163
Removing the power distribution board.....	163
Installing the power distribution board.....	164
Processor and heat sink module.....	165
Removing the processor and heat sink module.....	165
Removing the processor.....	167
Installing the processor.....	168
Installing the processor and heat sink module.....	171
Processor expansion module.....	173
Removing the processor expansion module (PEM).....	173
Installing the processor expansion module (PEM).....	175
PEM power board.....	176

Removing the PEM power board.....	176
Installing the PEM power board.....	177
Optional BOSS-N1 module.....	178
Removing the BOSS-N1 module blank.....	178
Installing the BOSS-N1 module blank.....	179
Removing the BOSS-N1 card carrier blank.....	179
Installing the BOSS-N1 card carrier blank.....	180
Removing the BOSS-N1 module.....	180
Installing the BOSS-N1 module.....	182
System battery	185
Replacing the system battery.....	185
Optional internal USB card.....	186
Removing the internal USB card.....	186
Installing the internal USB card.....	187
Intrusion switch.....	189
Removing the intrusion switch module.....	189
Installing the intrusion switch module.....	190
Optional OCP card.....	191
Removing the OCP card.....	191
Installing the OCP card.....	192
Power supply unit.....	194
Hot spare feature.....	194
Removing a power supply unit blank.....	194
Installing a power supply unit blank.....	195
Removing a power supply unit adapter.....	195
Installing a power supply unit adapter.....	196
Removing a power supply unit.....	197
Installing a power supply unit.....	198
Trusted Platform Module.....	199
Upgrading the Trusted Platform Module.....	199
Initializing TPM for users.....	200
Initializing the TPM 2.0 for users.....	200
System board.....	201
Removing the system board.....	201
Installing the system board.....	202
Restoring the system using Easy Restore.....	204
Manually update the Service Tag.....	204
LOM card, MIC card, and rear I/O board.....	204
Removing the LOM card and rear I/O board.....	204
Installing the LOM card and rear I/O board.....	206
Control panel.....	207
Removing the right control panel.....	207
Installing the right control panel.....	209
Removing the left control panel.....	210
Installing the left control panel.....	211
Chapter 8: Upgrade Kits.....	213
BOSS-N1 module kit.....	213

Chapter 9: Jumpers and connectors.....	215
System board Connectors.....	215
System board jumper settings.....	219
Disabling a forgotten password.....	219
Chapter 10: System diagnostics and indicator codes.....	221
Power button LED.....	221
Status LED indicators.....	221
System health and system ID indicator codes.....	223
iDRAC Quick Sync 2 indicator codes.....	224
iDRAC Direct LED indicator codes.....	224
LCD panel.....	225
Viewing Home screen.....	226
Setup menu.....	226
View menu.....	226
NIC indicator codes.....	227
Power supply unit indicator codes.....	227
Drive indicator codes.....	229
EDSFF E3.S drive led codes.....	230
Using system diagnostics.....	230
Dell Embedded System Diagnostics.....	231
Chapter 11: Getting help.....	232
Recycling or End-of-Life service information.....	232
Contacting Dell Technologies.....	232
Accessing system information by using QRL.....	232
Quick Resource Locator for PowerEdge R960 system.....	233
Receiving automated support with Secure Connect Gateway (SCG).....	233
Chapter 12: Documentation resources.....	234

About this document

This document provides an overview about the system, information about installing and replacing components, diagnostic tools, and guidelines to be followed while installing certain components.

Dell PowerEdge R960 system overview

The PowerEdge R960 system is a 4U server that supports:

- Up to four 4th Gen Intel® Xeon® Scalable Processors with up to 60 cores
- 64 DIMM slots
- Four AC or DC power supply units with 2+2 redundancy
- Up to 8 x 2.5-inch SAS/SATA (HDD/SSD) drives
- Up to 16 x 2.5-inch SAS/SATA (HDD/SSD) drives
- Up to 32 x 2.5-inch SAS/SATA (HDD/SSD) drives
- Up to 24 x 2.5-inch NVMe (SSD) drives
- Up to 16 x 2.5-inch SAS/SATA (HDD/SSD) + 8 x 2.5-inch NVMe (SSD) drives
- Up to 16 x EDSFF E3.S Gen5 NVMe (SSD) drives
- Up to 16 x EDSFF E3.S Gen5 NVMe (SSD) + 8 x 2.5-inch SAS/SATA (HDD/SSD) drives

i **NOTE:** For more information about how to hot swap NVMe PCIe SSD U.2 device, see the *Dell Express Flash NVMe PCIe SSD User's Guide* at <https://www.dell.com/support> > **Browse all products** > **Infrastructure** > **Data Center Infrastructure** > **Storage Adapters & Controllers** > **Dell PowerEdge Express Flash NVMe PCIe SSD** > **Select This Product** > **Documentation** > **Manuals and Documents**.

i **NOTE:** All instances of SAS, SATA, and NVMe drives are referred to as drives in this document, unless specified otherwise.

△ CAUTION: Do not install GPUs, network cards, or other PCIe devices on your system that are not validated and tested by Dell. Damage caused by unauthorized and invalidated hardware installation will null and void the system warranty.

Topics:

- [Front view of the system](#)
- [Rear view of the system](#)
- [Inside the system](#)
- [Locating the Express Service Code and Service Tag](#)
- [System information labels](#)
- [Rail sizing and rack compatibility matrix](#)

Front view of the system

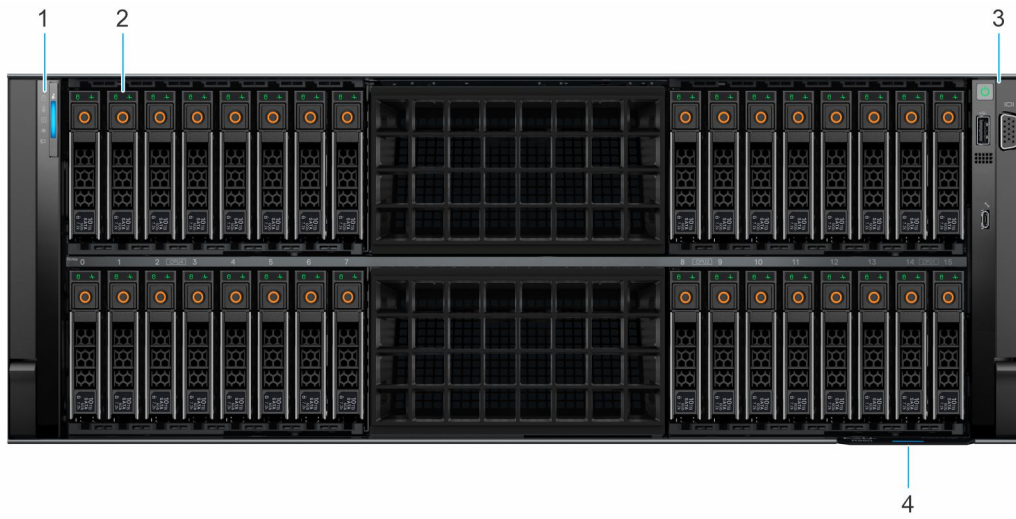

Figure 1. Front view of 32 x 2.5-inch drive system

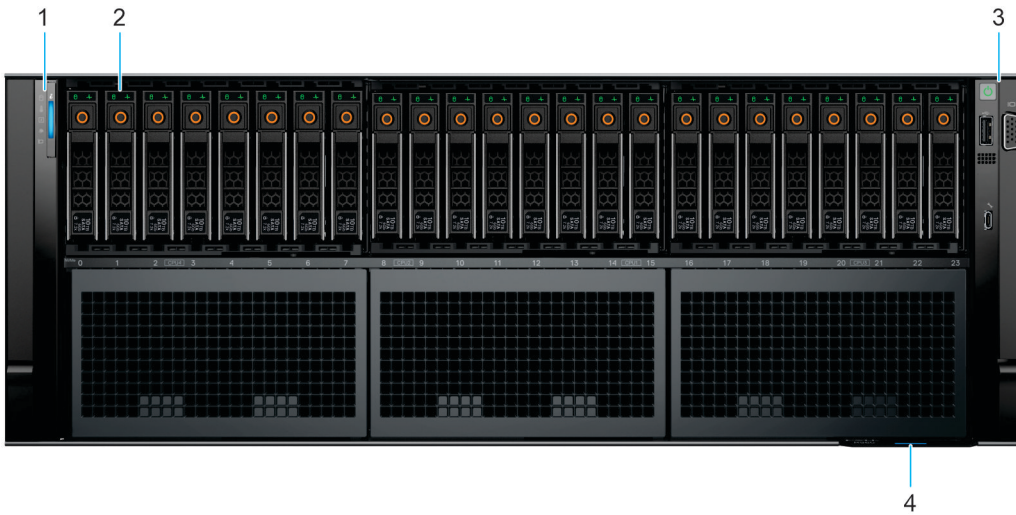

Figure 2. Front view of 24 x 2.5-inch drive system

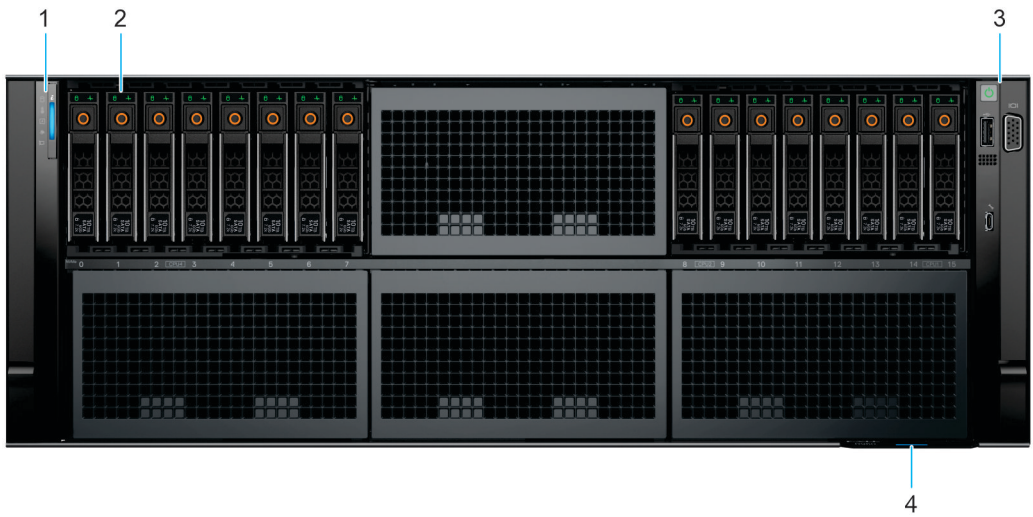

Figure 3. Front view of 16 x 2.5-inch drive system

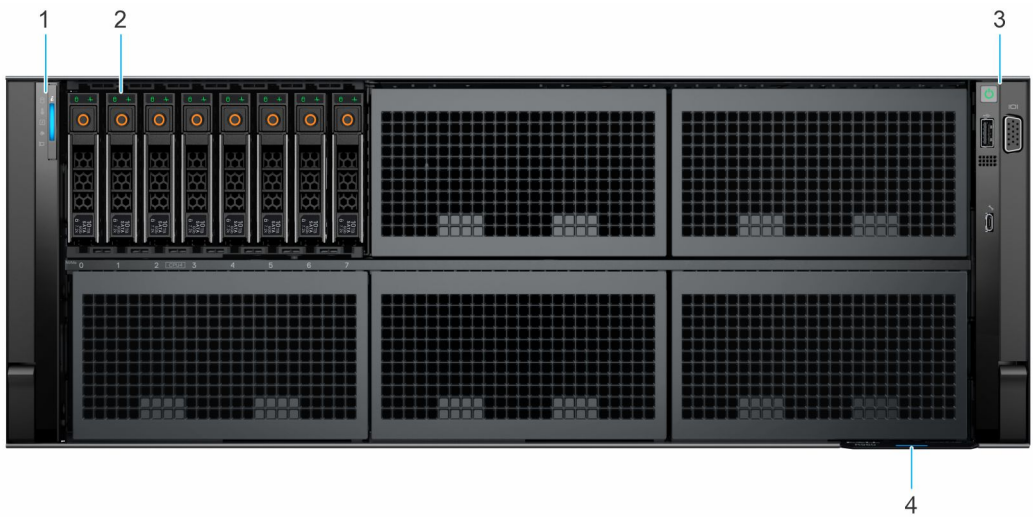

Figure 4. Front view of 8 x 2.5-inch drive system

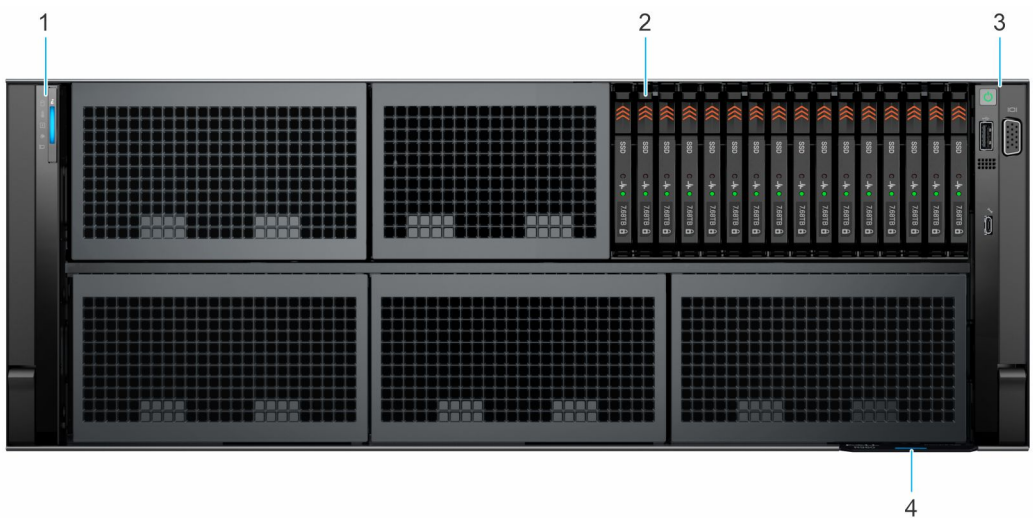

Figure 5. Front view of 16 x EDSFF E3.S drive system

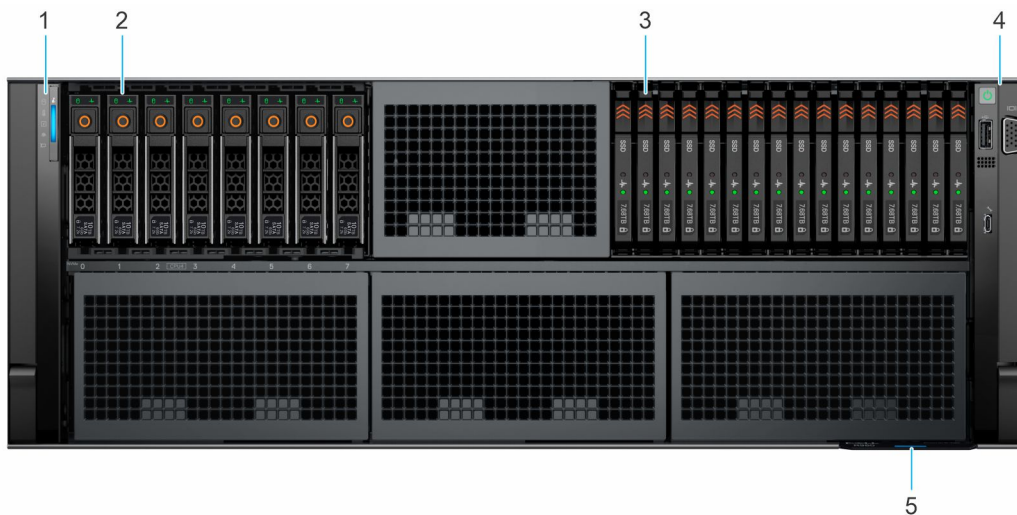

Figure 6. Front view of 8 x 2.5-inch with 16 x EDSFF E3.S drive system

Table 1. Features available on the front of the system

Item	Ports, panels, and slots	Icon	Description
1	Left control panel	N/A	Contains the system health, system ID, and the status LED indicator.
2	Drive	N/A	Enables you to install drives that are supported on your system. NOTE: For drive slot numbers, see the System information labels section.
3	Right control panel	N/A	Contains the power button, VGA port, USB port, iDRAC Direct (Micro-AB USB) port, and the iDRAC Direct status LED.
4	Express Service Tag	N/A	The Express Service Tag is a slide-out label panel that contains system information such as Service Tag, NIC, MAC address, and so on. If you have opted for the secure default access to iDRAC, the Information tag will also contain the iDRAC secure default password.

NOTE: For more information about ports, panels, and slots, see the [Technical specification](#) section.

Left control panel view



Figure 7. Left control panel

Table 2. Left control panel

Item	Indicator, button, or connector	Icon	Description
1	System health and system ID		Indicates the system health. For more information, see the System health and system ID indicator codes section.
2	Status LED indicators	N/A	Indicates the status of the system. For more information, see the Status LED indicators section.

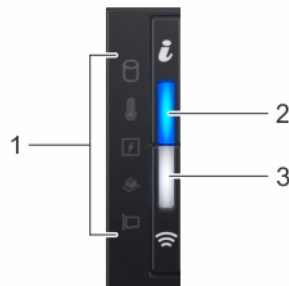

Figure 8. Left control panel with optional iDRAC Quick Sync 2 indicator

Table 3. Left control panel with optional iDRAC Quick Sync 2 indicator

Item	Indicator, button, or connector	Icon	Description
1	Status LED indicators	N/A	Indicates the status of the system. For more information, see the Status LED indicators section.
2	System health and system ID indicator		Indicates the system health. For more information, see the System health and system ID indicator codes section.
3	iDRAC Quick Sync 2 wireless indicator (optional)		Indicates if the iDRAC Quick Sync 2 wireless option is activated. The Quick Sync 2 feature allows management of the system using mobile devices. This feature aggregates hardware/

Table 3. Left control panel with optional iDRAC Quick Sync 2 indicator (continued)

Item	Indicator, button, or connector	Icon	Description
			firmware inventory and various system level diagnostic/error information that can be used in troubleshooting the system. You can access system inventory, Dell Lifecycle Controller logs or system logs, system health status, and also configure iDRAC, BIOS, and networking parameters. You can also launch the virtual Keyboard, Video, and Mouse (KVM) viewer and virtual Kernel-based Virtual Machine (KVM), on a supported mobile device. For more information, see the Integrated Dell Remote Access Controller User's Guide at www.dell.com/poweredgemanuals .

NOTE: For more information about the indicator codes, see the [System diagnostics and indicator codes](#) section.

Right control panel view

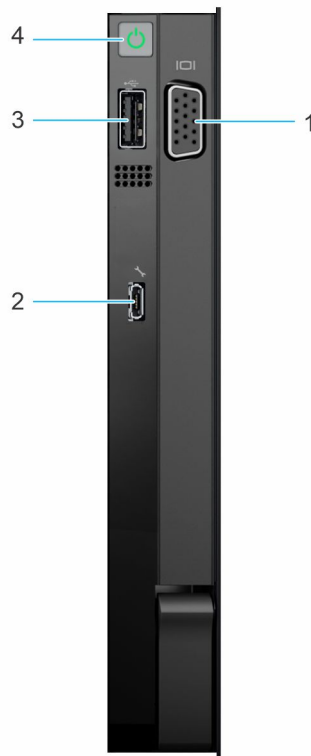



Figure 9. Right control panel

Table 4. Right control panel

Item	Indicator or button	Icon	Description
1	VGA port		Enables you to connect a display device to the system.
2	iDRAC Direct (Micro-AB USB) port		The iDRAC Direct (Micro-AB USB) port enables you to access the iDRAC direct Micro-AB USB features. For more information, see the <i>Integrated Dell Remote Access Controller User's Guide</i> at www.dell.com/poweredgemanuals .

Table 4. Right control panel (continued)

Item	Indicator or button	Icon	Description
			<p>NOTE: You can configure iDRAC Direct by using a USB to micro USB (type AB) cable, which you can connect to your laptop or tablet. Cable length should not exceed 3 feet (0.91 meters). Performance could be affected by cable quality.</p>
3	USB 2.0 port		The USB port is 4-pin, 2.0-compliant. This port enables you to connect USB devices to the system.
4	Power button		<p>Indicates if the system is powered on or off. Press the power button to manually power on or off the system.</p> <p>NOTE: Press the power button to gracefully shut down an ACPI-compliant operating system.</p>

NOTE: For more information about ports, panels, and slots, see the [Technical specification](#) section.

Rear view of the system

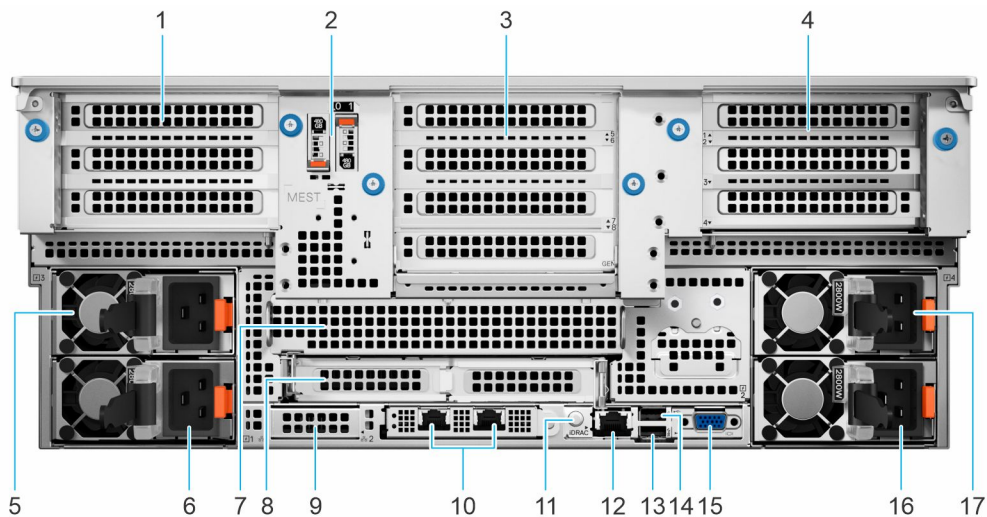

Figure 10. Rear view of the system

Table 5. Rear view of the system









Item	Ports, panels, or slots	Icon	Description
1	PCIe expansion card riser 1 (slot 1, slot 2 and slot 3)	N/A	The expansion card riser enables you to connect PCI Express expansion cards. For more information , see the Expansion card installation guidelines section.
2	BOSS-N1 module	N/A	BOSS-N1 module for internal system boot.
3	PCIe expansion card riser 3 (slot 5, slot 6, slot 7 and slot 8)	N/A	The expansion card riser enables you to connect PCI Express expansion cards. For more information , see the Expansion card installation guidelines section.
4	PCIe expansion card riser 4 (slot 10, slot 11 and slot 12)	N/A	The expansion card riser enables you to connect PCI Express expansion cards. For more information , see the Expansion card installation guidelines section.
5	Power supply unit (PSU3)		PSU3 is the third PSU of the system.
6	Power supply unit (PSU1)		PSU1 is the primary PSU of the system.

Table 5. Rear view of the system (continued)

Item	Ports, panels, or slots	Icon	Description
7	VGA bracket blank	N/A	Enables you to add VGA port and Serial COM port.
8	PCIe expansion card riser 2 (slot 3 and slot 9)	N/A	The expansion card riser enables you to connect PCI Express expansion cards. For more information , see the Expansion card installation guidelines section.
9	NIC ports blank (optional)		The NIC ports that are integrated on the LOM card provide network connectivity which is connected to the system board.
10	OCP NIC card (optional)	N/A	The OCP NIC card supports OCP 3.0. The NIC ports are integrated on the OCP card which is connected to the system board.
11	System Identification (ID) button		<p>The System Identification (ID) button is available on the front and back of the system. Press the button to identify a system in a rack by turning on the system ID button. You can also use the system ID button to reset iDRAC and to access BIOS using the step through mode. When pressed, the system ID LED in the back panel blinks until either the front or rear button is pressed again. Press the button to toggle between on or off mode.</p> <p>NOTE: If the server stops responding during POST, press and hold the System ID button for more than five seconds to enter the BIOS progress mode</p> <p>NOTE: To reset the iDRAC (if not disabled on the iDRAC setup page by pressing F2 during system boot), press and hold the System ID button for more than 15 seconds.</p>
12	Dedicated iDRAC9 Ethernet port	iDRAC	Enables you to remotely access iDRAC. For more information, see the <i>Integrated Dell Remote Access Controller User's Guide</i> at www.dell.com/poweredgemanuals .
13	USB 3.0 port		The USB port is 9-pin and 3.0-compliant. This port enables you to connect USB devices to the system.
14	USB 2.0 port		The USB port is 4-pin, 2.0-compliant. This port enables you to connect USB devices to the system.
15	VGA port		Enables you to connect a display device to the system.
16	Power supply unit (PSU2)		PSU2 is the secondary PSU of the system.
17	Power supply unit (PSU4)		PSU4 is the third PSU of the system.

NOTE: For more information about ports, panels, and slots, see the [Technical specification](#) section.

Inside the system

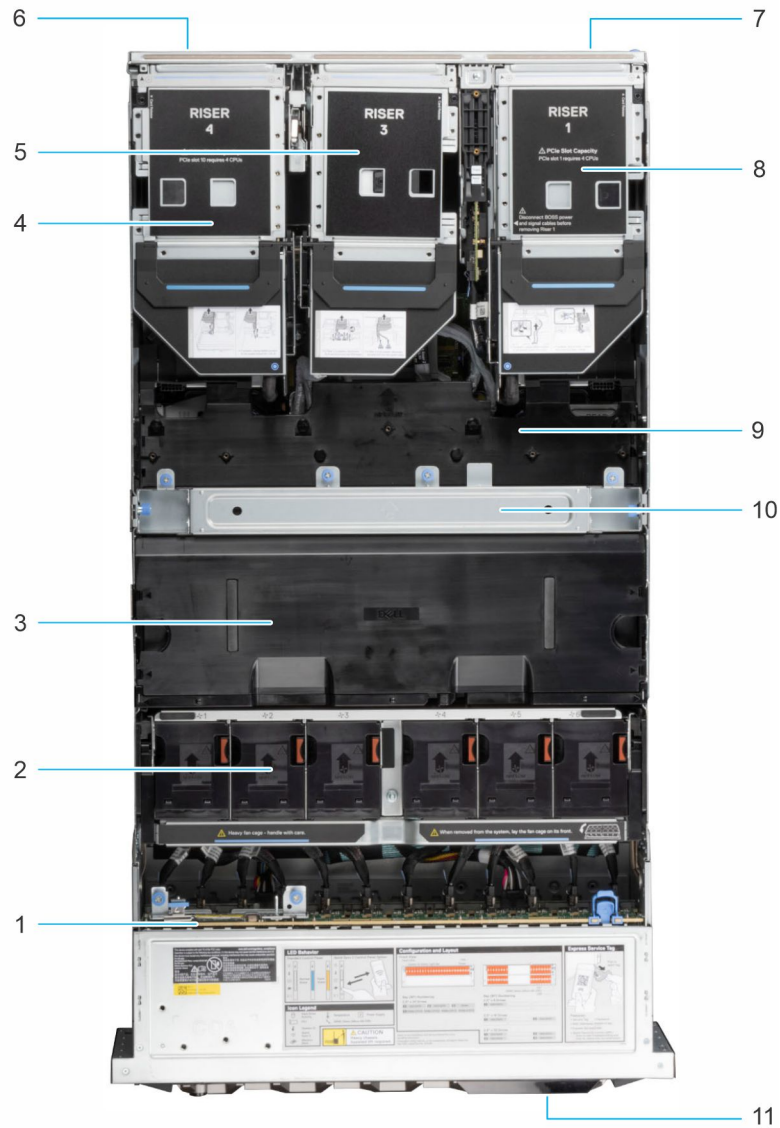

Figure 11. Inside the system

- | | |
|---------------------------------------|---------------------------------------|
| 1. Backplane | 2. Cooling fans |
| 3. Air shroud top cover | 4. Expansion riser 4 |
| 5. Expansion riser 3 | 6. Power supply units (PSU2 and PSU4) |
| 7. Power supply units (PSU1 and PSU3) | 8. Expansion riser 1 |
| 9. Air shroud bottom cover | 10. Support bar |
| 11. Express Service Tag | |

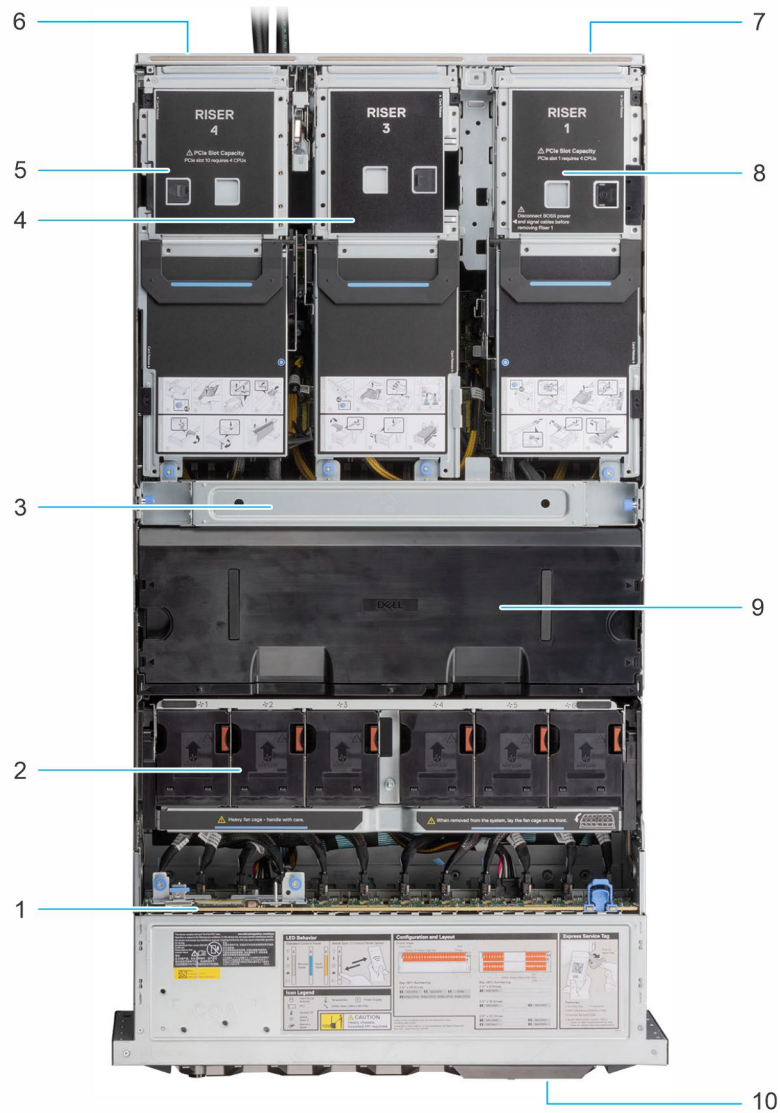

Figure 12. Inside the system with full length risers and GPU air shroud

- | | |
|---------------------------------------|---------------------------------------|
| 1. Backplane | 2. Cooling fans |
| 3. Support bar | 4. Expansion riser 3 |
| 5. Expansion riser 4 | 6. Power supply units (PSU2 and PSU4) |
| 7. Power supply units (PSU1 and PSU3) | 8. Expansion riser 1 |
| 9. GPU air shroud top cover | 10. Express Service Tag |

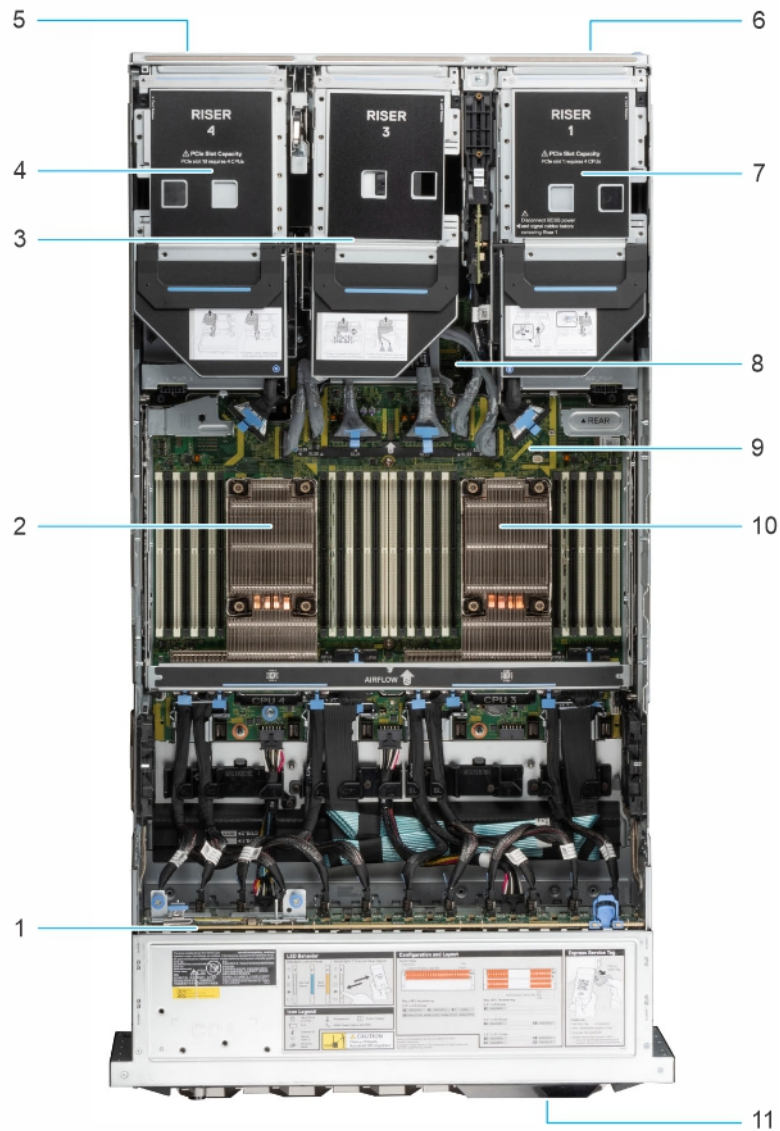

Figure 13. Inside the system with processor expansion module (PEM)

- | | |
|---------------------------------------|---------------------------------------|
| 1. Backplane | 2. Processor 4 |
| 3. Expansion riser 3 | 4. Expansion riser 4 |
| 5. Power supply units (PSU2 and PSU4) | 6. Power supply units (PSU1 and PSU3) |
| 7. Expansion riser 1 | 8. System board |
| 9. Processor expansion module (PEM) | 10. Processor 3 |
| 11. Express Service Tag | |

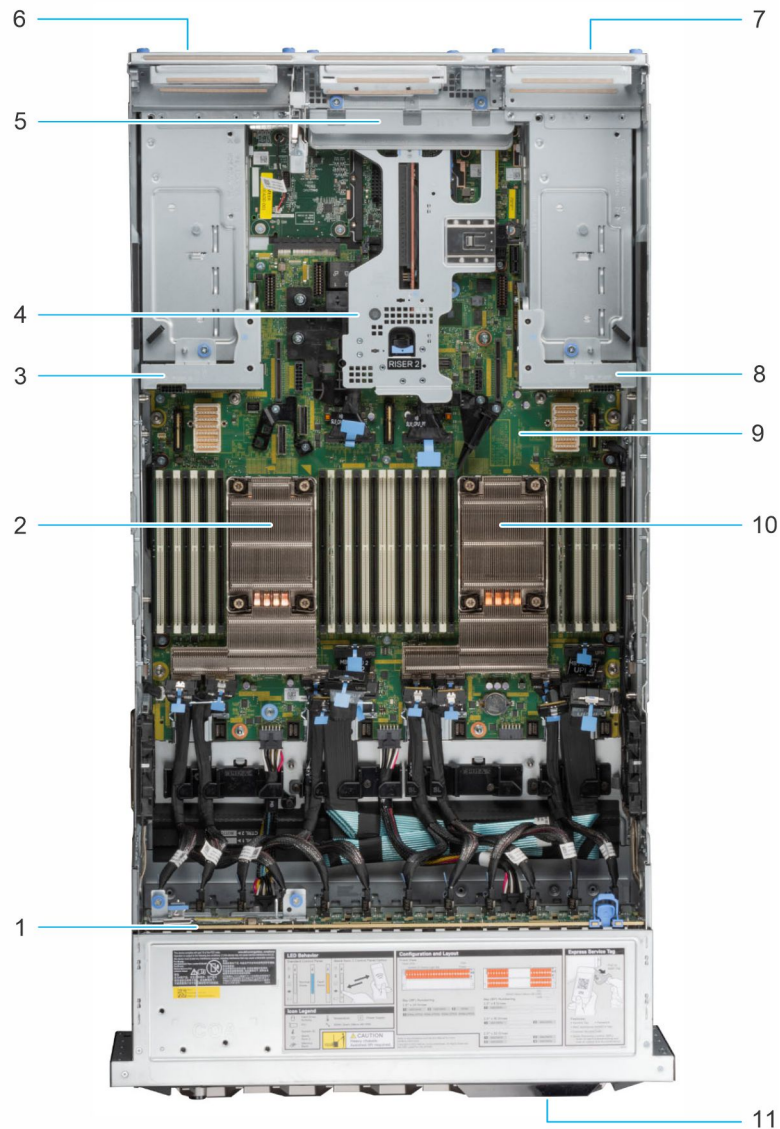

Figure 14. Inside the system with system board

- | | |
|---------------------------------------|---------------------------------------|
| 1. Backplane | 2. Processor 2 |
| 3. Power distribution board (PDB) | 4. Expansion riser 2 |
| 5. VGA bracket | 6. Power supply units (PSU2 and PSU4) |
| 7. Power supply units (PSU1 and PSU3) | 8. Power distribution board (PDB) |
| 9. System board | 10. Processor 1 |
| 11. Express Service Tag | |

Locating the Express Service Code and Service Tag

The unique Express Service Code and Service Tag are used to identify the system.

The Express Service Tag is located on the front of the system that includes system information such as the Service Tag, Express Service Code, Manufacture date, NIC, MAC address, QRL label, and so on. If you have opted for the secure default access to iDRAC, the Information tag also contains the iDRAC secure default password. If you have opted for iDRAC Quick Sync 2, the Information tag also contains the OpenManage Mobile (OMM) label, where administrators can configure, monitor, and troubleshoot the PowerEdge servers.

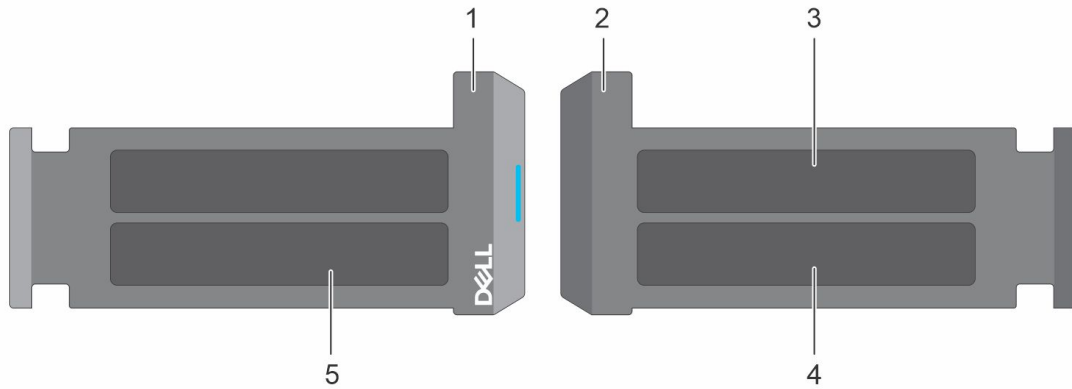

Figure 15. Locating the Express Service Code and Service tag

1. Express Service Tag (front view)
2. Express Service Tag (rear view)
3. OpenManage Mobile (OMM) label
4. iDRAC MAC address and iDRAC secure password label
5. Service Tag, Express Service Code, QRL label

The Mini Enterprise Service Tag (MEST) label is on the rear of the system that includes the Service Tag (ST), and Express Service Code (Exp Svc Code). The Exp Svc Code is used by Dell to route support calls to the appropriate personnel.

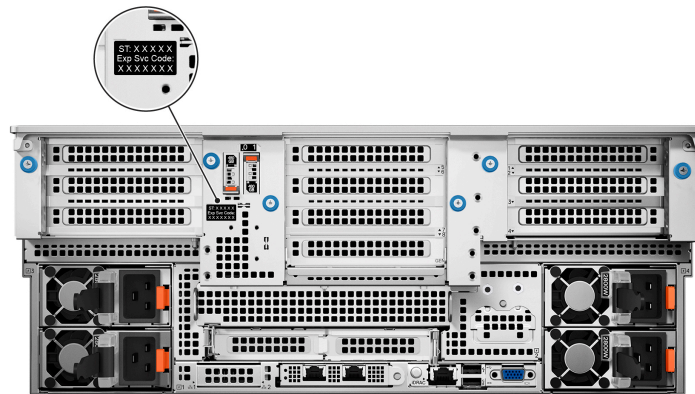

Figure 16. Locating the Mini Express Service Tag

System information labels

The system information label is on the rear side of the system cover.

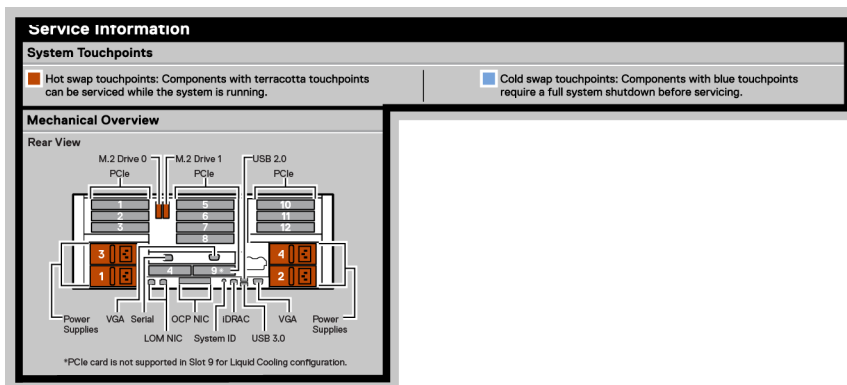

Figure 17. Service information

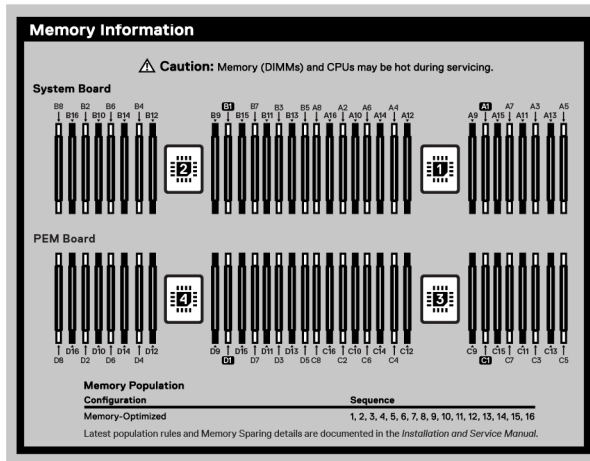

Figure 18. Memory information

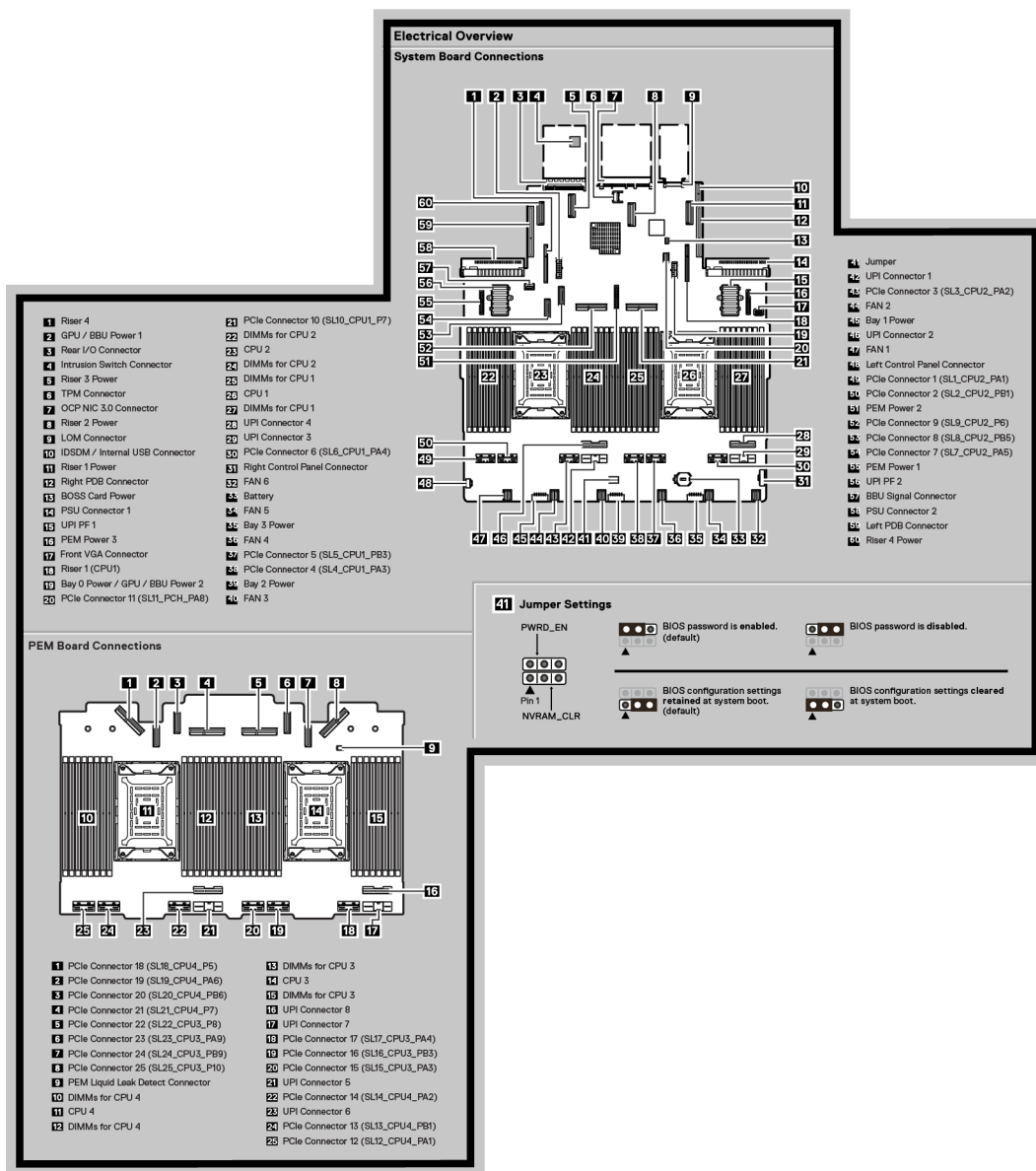

Figure 19. Electrical overview

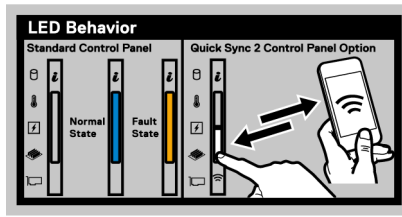

Figure 20. LED behavior

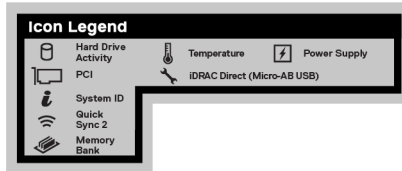

Figure 21. Icon legend

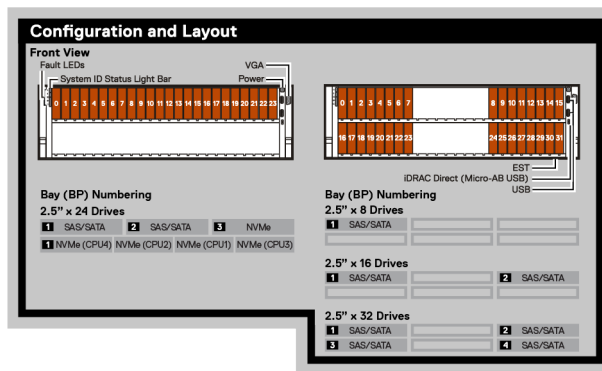

Figure 22. Configuration and layout

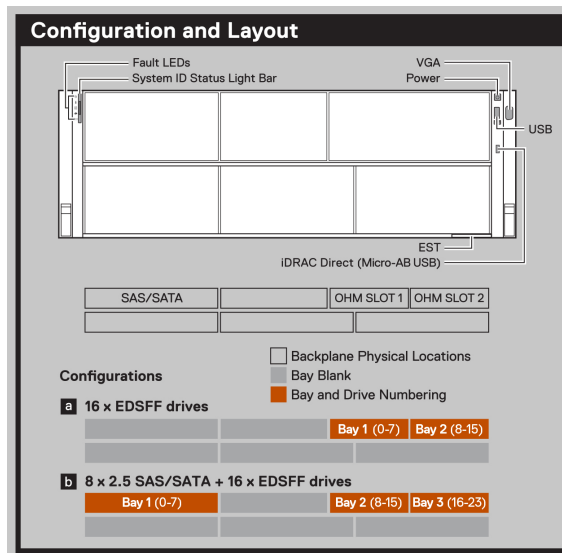

Figure 23. EDSFF E3.S configuration and layout

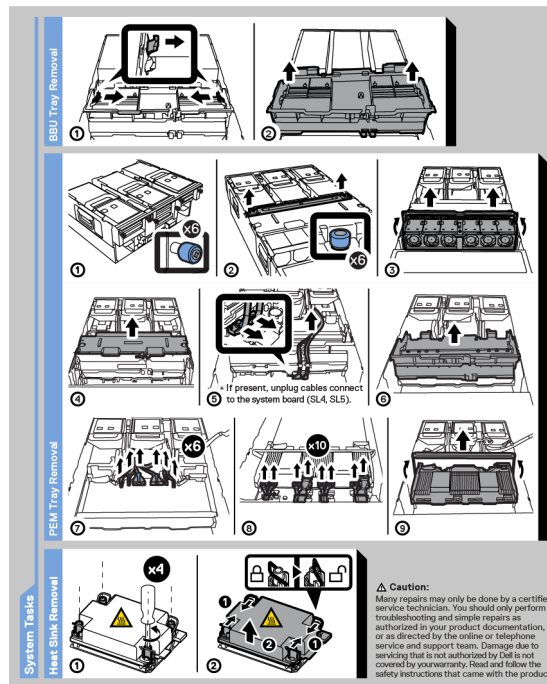

Figure 24. System tasks

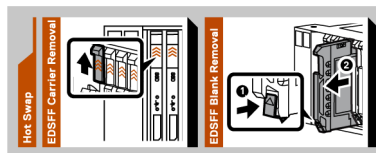

Figure 25. EDSFF E3.S drives



Figure 26. Weight caution

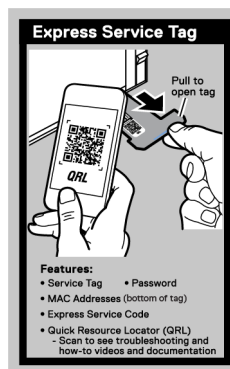

Figure 27. Express service tag

Rail sizing and rack compatibility matrix

For specific information about the rail solutions compatible with your system, see the *Dell Enterprise Systems Rail Sizing and Rack Compatibility Matrix* available at https://i.dell.com/sites/csdocuments/Business_solutions_engineering-Docs_Documents/en/rail-rack-matrix.pdf.

The document provides the information that is listed below:

- Specific details about rail types and their functionalities.
- Rail adjustability range for various types of rack mounting flanges.
- Rail depth with and without cable management accessories.
- Types of racks supported for various types of rack mounting flanges.

Technical specifications

The technical and environmental specifications of your system are outlined in this section.

Topics:

- [Chassis dimensions](#)
- [System weight](#)
- [Processor specifications](#)
- [PSU specifications](#)
- [Cooling fan specifications](#)
- [Supported operating systems](#)
- [System battery specifications](#)
- [Expansion card riser specifications](#)
- [Memory specifications](#)
- [Storage controller specifications](#)
- [Drives](#)
- [Ports and connectors specifications](#)
- [Video specifications](#)
- [Environmental specifications](#)

Chassis dimensions

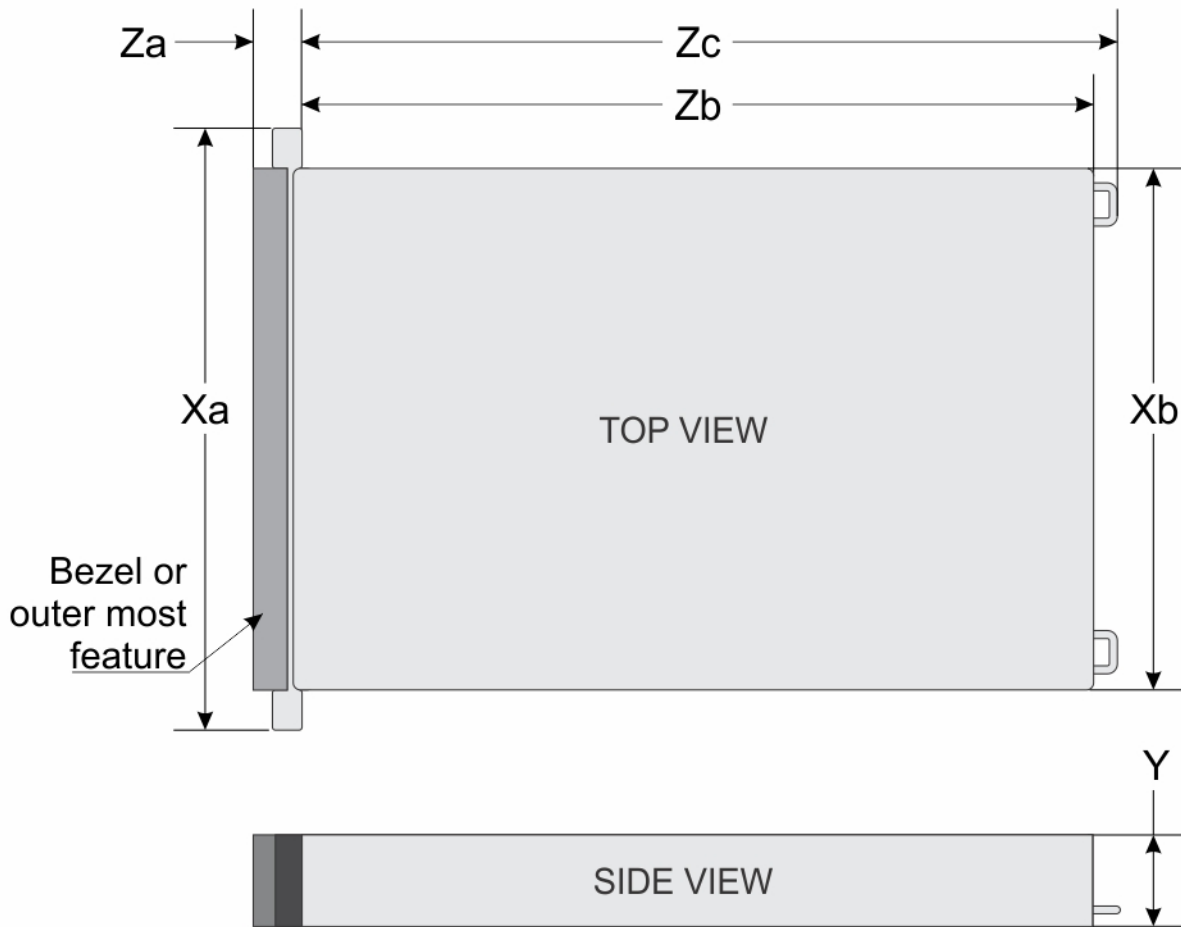

Figure 28. Chassis dimensions

Table 6. PowerEdge R960 chassis dimensions

Drives	Xa	Xb	Y	Za	Zb	Zc
For all drive configurations	482.0 mm (18.97 inches)	444.0 mm (17.48 inches)	174.3 mm (6.86 inches)	36 mm (1.41 inches) With bezel 22 mm (0.86 inches) Without bezel	844.74 mm (33.25 inches) Ear to rear wall	847.195 mm (33.35 inches) Ear to PSU handle

NOTE: Zb is the nominal rear wall external surface where the system board I/O connectors reside.

System weight

Table 7. PowerEdge R960 system weight

System configuration	Maximum weight (with all drives)
A server with fully populated drives	60.2 kg (132.71 lbs)
A server without drives and PSU installed	N/A

Processor specifications

Table 8. PowerEdge R960 processor specifications

Supported processor	Number of processors supported
4 th Gen Intel® Xeon® Scalable Processors ("H" SKUs)	Up to four

PSU specifications

The PowerEdge R960 system supports up to four AC or DC power supply units (PSUs).

Table 9. PSU specifications

PSU	Class	Heat dissipation (maximum) (BTU/hr)	Frequency (Hz)	Voltage	AC		DC	Current (A)
					High line wattage (200—240 V AC)	Low line wattage (100—120 V AC)		
1100 W mixed mode	Titanium	4100	50/60	100—240 V AC	1100 W	1050 W	N/A	12—6.3
	N/A	4100	N/A	240 V DC	N/A	N/A	1100 W	5.2
1400 W mixed mode	Platinum	5250	50/60	100—240 V AC	1400 W	1050 W	N/A	12—8
	N/A	5250	N/A	240 V DC	N/A	N/A	1400 W	6.6
1800 W mixed mode	Titanium	6750	50/60	200—240 V AC	1800	N/A	N/A	10
	N/A	6750	N/A	240 V DC	N/A	N/A	1800 W	8.2
2400 W mixed mode	Platinum	9000	50/60	100—240 V AC	2400 W	1400 W	N/A	16—13.5
	N/A	9000	N/A	240 V DC	N/A	N/A	2400 W	11.2
2800 W mixed mode	Titanium	10500	50/60	200—240 V AC	2800 W	N/A	N/A	15.6
	N/A	10500	N/A	240 V DC	N/A	N/A	2800 W	13.6

- NOTE:** Heat dissipation is calculated using the PSU wattage rating.
- NOTE:** When selecting or upgrading the system configuration, to ensure optimum power utilization, verify the system power consumption with the Enterprise Infrastructure Planning Tool available at Dell.com/calc.
- NOTE:** If a system with AC 2400 W PSUs operates at low line 100-120 Vac, then the power rating per PSU is degraded to 1400 W.
- NOTE:** If a system with AC 1400 W or 1100 W PSUs operates at low line 100-120 Vac, then the power rating per PSU is degraded to 1050 W.



Figure 29. PSU power cords

Table 10. PSU power cords

Form factor	Output	Power cord
Redundant 60 mm	1100 W AC	C13
	1400 W AC	C13
	1800 W AC	C15
Redundant 86 mm	2400 W AC	C19
	2800 W AC	C21

NOTE: C19 power cord combined with C20 to C21 jumper power cord can be used to adapt 2800 W PSU.

NOTE: C13 power cord combined with C14 to C15 jumper power cord can be used to adapt 1800 W PSU.

NOTE: When installing a 60 mm PSU, a 26 mm PSU adapter is required, see [Installing a power supply unit adapter](#).

Cooling fan specifications

Cooling options

The PowerEdge R960 requires various cooling components that are based on processor TDP, storage modules, and GPU to maintain optimum thermal performance.

The PowerEdge R960 offers air cooling option.

Cooling fan specifications

The PowerEdge R960 system system supports up to six sets of Standard cooling fans.

Table 11. Cooling fan specifications

Fan type	Abbreviation	Label color	Label image
Standard (STD) fans	STD	N/A	

i **NOTE:** See the [Thermal restriction matrix](#) for required fan support with air cooled configurations.

Supported operating systems

The PowerEdge R960 system supports the following operating systems:

- Canonical Ubuntu Server LTS
- Microsoft Windows Server with Hyper-V
- Red Hat Enterprise Linux
- SUSE Linux Enterprise Server
- VMware ESXi

For more information, go to www.dell.com/ossupport.

System battery specifications

The PowerEdge R960 system uses one CR 2032 3.0 V lithium coin cell battery.

Expansion card riser specifications

The PowerEdge R960 system supports up to 12 PCI express (PCIe) Gen5 slots (10 Full Height and 2 Low Profiles) on the system board.

Table 12. Expansion card slots supported on the system board

Expansion card riser	PCIe slots	Processor connection	Height	Length	Slot width
Riser 1A	Slot 1	Processor 3	Full Height	Full Length	x16
	Slot 3	Processor 1	Full Height	Full Length	x16 (Double width GPU)
Riser 1B	Slot 1	Processor 3	Full Height	Half Length	x16
	Slot 2	Processor 1			
	Slot 3				
Riser 1C	Slot 1	Processor 3	Full Height	Half Length	x16
	Slot 3	Processor 1			
Riser 2	Slot 4	Processor 2	Low Profile	Half Length	x16
	Slot 9	Processor 1			
Riser 3A	Slot 6	Processor 4	Full Height	Full Length	x16 (Double width GPU)
	Slot 8	Processor 3			
Riser 3B	Slot 5	Processor 4	Full Height	Half Length	x16
	Slot 6				
	Slot 7	Processor 3			
	Slot 8				
Riser 3B (In scale out configuration)	Slot 5	Processor 4	Full Height	Half Length	x16
	Slot 6	Processor 2			
	Slot 7	Processor 3			
	Slot 8	Processor 1			
Riser 4A	Slot 10	Processor 4	Full Height	Full Length	x16
	Slot 11	Processor 2	Full Height	Full Length	x16 (Double width GPU)
Riser 4B	Slot 10	Processor 4	Full Height	Half Length	x16
	Slot 11	Processor 2			
	Slot 12				
Riser 4C	Slot 10	Processor 4	Full Height	Half Length	x16
	Slot 11	Processor 2			

Memory specifications

The PowerEdge R960 system supports the following memory specifications for optimized operation.

Table 13. Memory specifications

DIMM type	DIMM rank	DIMM capacity	Dual processor		Four processors	
			Minimum system capacity	Maximum system capacity	Minimum system capacity	Maximum system capacity
DDR5 RDIMM	Single rank	16 GB	32 GB	512 GB	64 GB	1 TB
	Dual rank	32 GB	64 GB	1 TB	128 GB	2 TB
	Dual rank	64 GB	128 GB	2 TB	256 GB	4 TB

Table 13. Memory specifications (continued)

DIMM type	DIMM rank	DIMM capacity	Dual processor		Four processors	
			Minimum system capacity	Maximum system capacity	Minimum system capacity	Maximum system capacity
	Quad rank	128 GB	256 GB	4 TB	512 GB	8 TB
	Octa rank	256 GB	512 GB	8 TB	1 TB	16 TB

NOTE: DDR4 memory DIMMs are not supported in the R960.

Table 14. Memory module sockets

Memory module sockets	Speed
64 (288-pin)	4800 MT/s, or 4400 MT/s

NOTE: The processor may reduce the performance of the rated DIMM speed.

NOTE: Memory DIMM slots are not hot pluggable.

Storage controller specifications

The PowerEdge R960 system supports the following controller cards:

Table 15. Storage controller cards

Supported storage controller cards
Internal controllers <ul style="list-style-type: none"> PERC H965i PERC H755 PERC H355
External controllers <ul style="list-style-type: none"> HBA355e PERC H965e
Internal Boot <ul style="list-style-type: none"> Boot Optimized Storage Subsystem (BOSS-N1): HWRAID 2 x M.2 NVMe SSD USB
Software RAID <ul style="list-style-type: none"> S160
SAS Host Bus Adapters (HBA) <ul style="list-style-type: none"> HBA355i

Drives

The PowerEdge R960 system supports:

- 8 x 2.5-inch hot-swappable SAS/SATA (HDD/SSD) drives
- 16 x 2.5-inch hot-swappable SAS/SATA (HDD/SSD) drives
- 32 x 2.5-inch hot-swappable SAS/SATA (HDD/SSD) drives
- 24 x 2.5-inch hot-swappable NVMe (SSD) drives
- 16 x 2.5-inch hot-swappable SAS/SATA (HDD/SSD) + 8 x 2.5-inch hot-swappable NVMe (SSD) drives
- Up to 16 x EDSFF E3.S Gen5 NVMe (SSD) drives
- Up to 16 x EDSFF E3.S Gen5 NVMe (SSD) + 8 x 2.5-inch SAS/SATA (HDD/SSD) drives

NOTE: For more information about how to hot swap NVMe PCIe SSD U.2 device, see the *Dell Express Flash NVMe PCIe SSD User's Guide* at <https://www.dell.com/support> > **Browse all products** > **Infrastructure** > **Data Center Infrastructure** > **Storage Adapters & Controllers** > **Dell PowerEdge Express Flash NVMe PCIe SSD** > **Select This Product** > **Documentation** > **Manuals and Documents.**

Ports and connectors specifications

USB ports specifications

Table 16. PowerEdge R960 USB specifications

Front		Rear		Internal (Optional)	
USB port type	No. of ports	USB port type	No. of ports	USB port type	No. of ports
USB 2.0-compliant port	One	USB 2.0-compliant port	One	Internal USB 3.0-compliant port	One
iDRAC Direct port (Micro-AB USB 2.0-compliant port)	One	USB 3.0-compliant port	One		

NOTE: The micro USB 2.0 compliant port can only be used as an iDRAC Direct or a management port.

NIC port specifications

The PowerEdge R960 system supports up to two Network Interface Controller (NIC) ports embedded on the LAN on Motherboard (LOM) card and up to four ports integrated on the Open Compute Project (OCP) card.

Table 17. NIC port specification for the system

Feature	Specifications
LOM card (optional)	1 GbE x 2
OCP card (OCP 3.0) (optional)	1 GbE x 4, 10 GbE x 2, 10 GbE x 4, 25 GbE x 2, 25 GbE x 4, 100 GbE x 2

NOTE: The system allows either LOM card or an OCP card or both to be installed in the system.

Serial connector specifications

The PowerEdge R960 system supports one optional card type serial connector, which is a 9-pin connector, Data Terminal Equipment (DTE), 16550-compliant.

The optional serial connector card is installed similar to an expansion card filler bracket.

VGA ports specifications

The PowerEdge R960 system supports DB-15 VGA port on front panel and on rear I/O board (optional for Direct Liquid Cooling configuration).

Video specifications

The PowerEdge R960 system supports integrated Matrox G200 graphics controller with 16 MB of video frame buffer.

Table 18. Video specifications for R960

Resolution	Refresh rate (Hz)	Color depth (bits)
1024 x 768	60	8, 16, 32
1280 x 800	60	8, 16, 32
1280 x 1024	60	8, 16, 32
1360 x 768	60	8, 16, 32
1440 x 900	60	8, 16, 32
1600 x 900	60	8, 16, 32
1600 x 1200	60	8, 16, 32
1680 x 1050	60	8, 16, 32
1920 x 1080	60	8, 16, 32
1920 x 1200	60	8, 16, 32

Environmental specifications

i **NOTE:** For additional information about environmental certifications, refer to the *Product Environmental Datasheet* located with the *Documentation* on www.dell.com/support/home.

Table 19. Continuous Operation Specifications for ASHRAE A2

Temperature	Specifications
Allowable continuous operations	
Temperature range for altitudes < 900 m (< 2953 ft)	10–35°C (50–95°F) with no direct sunlight on the equipment
Humidity percent range (non-condensing at all times)	8% RH with -12°C (10.4°F) minimum dew point to 80% RH with 21°C (69.8°F) maximum dew point
Operational altitude de-rating	Maximum temperature is reduced by 1°C/300 m (1.8°F/984 Ft) above 900 m (2953 Ft)

Table 20. Continuous Operation Specifications for ASHRAE A3

Temperature	Specifications
Allowable continuous operations	
Temperature range for altitudes ≤ 900 m (≤ 2953 ft)	5–40°C (41–104°F) with no direct sunlight on the equipment
Humidity percent range (non-condensing at all times)	8% RH with -12°C (10.4°F) minimum dew point to 85% RH with 24°C (75.2°F) maximum dew point
Operational altitude de-rating	Maximum temperature is reduced by 1°C/175 m (1.8°F/574 Ft) above 900 m (2953 Ft)

Table 21. Continuous Operation Specifications for ASHRAE A4

Temperature	Specifications
Allowable continuous operations	

Table 21. Continuous Operation Specifications for ASHRAE A4 (continued)

Temperature	Specifications
Temperature range for altitudes <= 900 m (<= 2953 ft)	5–45°C (41–113°F) with no direct sunlight on the equipment
Humidity percent range (non-condensing at all times)	8% RH with -12°C (10.4°F) minimum dew point to 90% RH with 24°C (75.2°F) maximum dew point
Operational altitude de-rating	Maximum temperature is reduced by 1°C/125 m (1.8°F/410 Ft) above 900 m (2953 Ft)

Table 22. Common Environmental Specifications for ASHRAE A2, A3 and A4

Temperature	Specifications
Allowable continuous operations	
Maximum temperature gradient (applies to both operation and non-operation)	20°C in an hour* (36°F in an hour) and 5°C in 15 minutes (9°F in 15 minutes), 5°C in an hour* (9°F in an hour) for tape hardware <i>i</i> NOTE: * Per ASHRAE thermal guidelines for tape hardware, these are not instantaneous rates of temperature change.
Non-operational temperature limits	-40 to 65°C (-40 to 149°F)
Non-operational humidity limits (non-condensing at all times)	5% to 95% RH with 27°C (80.6°F) maximum dew point
Maximum non-operational altitude	12,000 meters (39,370 feet)
Maximum operational altitude	3,050 meters (10,006 feet)

Table 23. Maximum vibration specifications

Maximum vibration	Specifications
Operating	0.21 G _{rms} at 5 Hz to 500 Hz for 10 minutes (all operation orientations)
Storage	1.88 G _{rms} at 10 Hz to 500 Hz for 15 minutes (all six sides tested)

Table 24. Maximum shock pulse specifications

Maximum shock pulse	Specifications
Operating	Six consecutively executed shock pulses in the positive and negative x, y, and z axis of 6 G for up to 11 ms
Storage	Six consecutively executed shock pulses in the positive and negative x, y, and z axis (one pulse on each side of the system) of 71 G for up to 2 ms

Particulate and gaseous contamination specifications

The following table defines the limitations that help avoid any equipment damage or failure from particulates and gaseous contamination. If the levels of particulates or gaseous pollution exceed the specified limitations and result in equipment damage or failure, you may need to rectify the environmental conditions. Remediation of environmental conditions is the responsibility of the customer.

Table 25. Particulate contamination specifications

Particulate contamination	Specifications
Air filtration	Data center air filtration as defined by ISO Class 8 per ISO 14644-1 with a 95% upper confidence limit <i>i</i> NOTE: This condition applies to data center environments only. Air filtration requirements do not apply to IT equipment designed to be

Table 25. Particulate contamination specifications (continued)

Particulate contamination	Specifications
	<p>used outside a data center, in environments such as an office or factory floor.</p> <p>i NOTE: Air entering the data center must have MERV11 or MERV13 filtration.</p>
Conductive dust	<p>Air must be free of conductive dust, zinc whiskers, or other conductive particles</p> <p>i NOTE: This condition applies to data center and non-data center environments.</p>
Corrosive dust	<ul style="list-style-type: none"> • Air must be free of corrosive dust • Residual dust present in the air must have a deliquescent point less than 60% relative humidity <p>i NOTE: This condition applies to data center and non-data center environments.</p>
Walk-Up Edge Data Center or Cabinet (sealed, closed loop environment)	<p>Filtration is not required for cabinets that are anticipated to be opened 6 times or less per year. Class 8 per ISO 14666-1 filtration as defined above is required otherwise</p> <p>i NOTE: In environments commonly above ISA-71 Class G1 or that may have known challenges, special filters may be required.</p>

Table 26. Gaseous contamination specifications

Gaseous contamination	Specifications
Copper coupon corrosion rate	<300 Å/month per Class G1 as defined by ANSI/ISA71.04-2013
Silver coupon corrosion rate	<200 Å/month as defined by ANSI/ISA71.04-2013

Thermal restriction matrix

Table 27. Processor and heat sink matrix

Heat sink	Processor TDP
STD HSK	≤ 185 W
L-type HSK	≥ 195 W

Table 28. Label reference

Label	Description
STD	Standard fan
HSK	Heat sink
LP	Low Profile
FH	Full Height

i **NOTE:** The ambient temperature of the configuration is determined by the critical component in that configuration. For example, if the processor's supported ambient temperature is 35°C (95°F), the DIMM is 35°C (95°F), and the GPU is 30°C (86°F), the combined configuration can only support 30°C (86°F).

Table 29. Thermal restriction matrix for air cooled configurations

Configuration			32 x 2.5-inch SAS	16 x 2.5-inch SAS + 8 x 2.5-inch NVMe	24 x 2.5-inch NVMe	16 x 2.5-inch SAS	16 x EDSFF E3.S NVMe	8 x 2.5-inch SAS + 16 x EDSFF E3.S NVMe	8 x 2.5-inch SAS
Rear storage			No Rear Drives	No Rear Drives	No Rear Drives	No Rear Drives	No Rear Drives	No Rear Drives	No Rear Drives
Processor SKU	TDP	T-Case max center (°C)	Ambient temperature						
6416H	165 W	82	45°C (113°F)	35°C (95°F)	35°C (95°F)	45°C (113°F)	35°C (95°F)	35°C (95°F)	45°C (113°F)
6418H	185 W	81	45°C (113°F)	35°C (95°F)	35°C (95°F)	45°C (113°F)	35°C (95°F)	35°C (95°F)	45°C (113°F)
6434H	195 W	64	45°C (113°F)	35°C (95°F)	35°C (95°F)	45°C (113°F)	35°C (95°F)	35°C (95°F)	45°C (113°F)
6448H	250 W	83	40°C (104°F)	35°C (95°F)	35°C (95°F)	40°C (104°F)	35°C (95°F)	35°C (95°F)	40°C (104°F)
8450H	250 W	76	40°C (104°F)	35°C (95°F)	35°C (95°F)	40°C (104°F)	35°C (95°F)	35°C (95°F)	40°C (104°F)
8444H	270 W	72	40°C (104°F)	35°C (95°F)	35°C (95°F)	40°C (104°F)	35°C (95°F)	35°C (95°F)	40°C (104°F)
8454H	270 W	71	40°C (104°F)	35°C (95°F)	35°C (95°F)	40°C (104°F)	35°C (95°F)	35°C (95°F)	40°C (104°F)
8460H	330 W	76	35°C (95°F)	35°C (95°F)	35°C (95°F)	35°C (95°F)	35°C (95°F)	35°C (95°F)	35°C (95°F)
8468H	330 W	77	35°C (95°F)	35°C (95°F)	35°C (95°F)	35°C (95°F)	35°C (95°F)	35°C (95°F)	35°C (95°F)
8490H	350 W	79	35°C (95°F)	35°C (95°F)	35°C (95°F)	35°C (95°F)	35°C (95°F)	35°C (95°F)	35°C (95°F)
Memory			Ambient temperature						
256 GB RDIMM			35°C (95°F)	35°C (95°F)	35°C (95°F)	35°C (95°F)	35°C (95°F)	35°C (95°F)	35°C (95°F)
128 GB RDIMM			35°C (95°F)	35°C (95°F)	35°C (95°F)	35°C (95°F)	35°C (95°F)	35°C (95°F)	35°C (95°F)
64 GB RDIMM			N/A*	N/A*	N/A*	N/A*	N/A*	N/A*	N/A*
32 GB RDIMM			N/A*	N/A*	N/A*	N/A*	N/A*	N/A*	N/A*
16 GB RDIMM			N/A*	N/A*	N/A*	N/A*	N/A*	N/A*	N/A*
GPU			Ambient temperature						
Double width (300 W)			N/A	N/A	35°C (95°F)	35°C (95°F)	35°C (95°F)	35°C (95°F)	35°C (95°F)

- NOTE:** *Memory has the same thermal restrictions of the processor used.
- NOTE:** Up to six standard (STD) dual fan modules must be installed in all the configurations.
- NOTE:** GPU air shroud is required, when GPU is installed in the system.

NOTE: When riser slots four and nine are installed, the supported ambient temperature is 35°C (95°F).

NOTE: DIMM blanks must be installed in empty DIMM slots.

Thermal air restrictions

Table 30. Air cooling configurations thermal restriction for AHSRAE A3 and A4

ASHRAE	A3/40°C (104°F)	A4/45°C (113°F)
Processor	Processors with a TDP greater than or equal to 330 W are not supported.	Processors with a TDP greater than or equal to 250 W are not supported.
PSU	Four PSUs are required in redundant mode. If there is PSU failure, system performance may be reduced.	
PCIe card	Non-Dell qualified peripheral cards and peripheral cards greater than 25 W are not supported.	
GPU/FPGA	Not supported	
DIMM	128 GB, or greater capacity DIMMs are not supported.	
NVMe storage	2.5-inch NVMe storage is not supported.	
OCP	Supported with 85°C (185°F) active optic cable and cards tier >5 are not supported.	
BOSS	BOSS-N1 is not supported.	
PCIe slot	Slot numbers four and nine are not supported.	

Initial system setup and configuration

This section describes the tasks for initial setup and configuration of the Dell system. The section also provides general steps to set up the system and the reference guides for detailed information.

Topics:

- [Setting up the system](#)
- [iDRAC configuration](#)
- [Resources to install operating system](#)

Setting up the system

Perform the following steps to set up the system:

Steps

1. Unpack the system.
2. Install the system into the rack. For more information, see the rail installation and cable management accessory guides relevant to your rail and cable management solution at www.dell.com/poweredgemanuals.
3. Connect the peripherals to the system and the system to the electrical outlet.
4. Power on the system.

For more information about setting up the system, see the *Getting Started Guide* that is shipped with your system.

 **NOTE:** For information about managing the basic settings and features of the system, see the [Pre-operating system management applications](#) chapter.

iDRAC configuration

The Integrated Dell Remote Access Controller (iDRAC) is designed to make you more productive as a system administrator and improve the overall availability of Dell servers. iDRAC alerts you to system issues, helps you to perform remote management, and reduces the need for physical access to the system.

Options to set up iDRAC IP address

To enable communication between your system and iDRAC, you must first configure the network settings based on your network infrastructure. The network settings option is set to **DHCP**, by default.

 **NOTE:** For static IP configuration, you must request for the settings at the time of purchase.

You can set up the iDRAC IP address using one of the interfaces in the table below. For information about setting up iDRAC IP address, see the documentation links provided in the table below.

Table 31. Interfaces to set up iDRAC IP address

Interface	Documentation links
iDRAC Settings utility	<i>Integrated Dell Remote Access Controller User's Guide</i> at https://www.dell.com/idracmanuals or for system specific <i>Integrated Dell Remote Access Controller User's Guide</i> , go to https://www.dell.com/poweredgemanuals > Product Support page of your system > Documentation .

Table 31. Interfaces to set up iDRAC IP address (continued)

Interface	Documentation links
	<p>i NOTE: To determine the most recent iDRAC release for your platform and for latest documentation version, see KB article https://www.dell.com/support/article/sln000178115.</p>
OpenManage Deployment Toolkit	<p><i>Dell OpenManage Deployment Toolkit User's Guide</i> available at https://www.dell.com/openmanagemanuals > Open Manage Deployment Toolkit.</p>
iDRAC Direct	<p><i>Integrated Dell Remote Access Controller User's Guide</i> at https://www.dell.com/idracmanuals or for system specific <i>Integrated Dell Remote Access Controller User's Guide</i>, go to https://www.dell.com/poweredgemanuals > Product Support page of your system > Documentation.</p> <p>i NOTE: To determine the most recent iDRAC release for your platform and for latest documentation version, see KB article https://www.dell.com/support/article/sln000178115.</p>
Lifecycle Controller	<p><i>Dell Lifecycle Controller User's Guide</i> at https://www.dell.com/idracmanuals or for system specific <i>Dell Lifecycle Controller User's Guide</i>, go to https://www.dell.com/poweredgemanuals > Product Support page of your system > Documentation.</p> <p>i NOTE: To determine the most recent iDRAC release for your platform and for latest documentation version, see KB article https://www.dell.com/support/article/sln000178115.</p>
Server LCD panel	<p>LCD panel section.</p>
iDRAC Direct and Quick Sync 2 (optional)	<p><i>Integrated Dell Remote Access Controller User's Guide</i> at https://www.dell.com/idracmanuals or for system specific <i>Integrated Dell Remote Access Controller User's Guide</i>, go to https://www.dell.com/poweredgemanuals > Product Support page of your system > Documentation.</p> <p>i NOTE: To determine the most recent iDRAC release for your platform and for latest documentation version, see KB article https://www.dell.com/support/article/sln000178115.</p>

i **NOTE:** To access iDRAC, ensure that you connect the ethernet cable to the iDRAC dedicated network port or use the iDRAC Direct port by using the micro USB (type AB) cable. You can also access iDRAC through the shared LOM mode, if you have opted for a system that has the shared LOM mode enabled.

Options to log in to iDRAC

To log in to the iDRAC Web User Interface, open a browser and enter the IP address.

You can log in to iDRAC as:

- iDRAC user
- Microsoft Active Directory user
- Lightweight Directory Access Protocol (LDAP) user

In the login screen displayed, if you have opted for secure default access to iDRAC, the default username is `root` and enter the iDRAC secure default password available on back of the Information Tag. If you opted for legacy password, use the iDRAC legacy username and password - `root` and `calvin`, the iDRAC default password will be blank on the information tag. Then you

will be prompted and required to create a password of your choice before proceeding. You can also log in by using your Single Sign-On or Smart Card.

NOTE: Ensure that you change the default username and password after setting up the iDRAC IP address.

For more information about logging in to the iDRAC and iDRAC licenses, see the latest *Integrated Dell Remote Access Controller User's Guide* at www.dell.com/idracmanuals.

NOTE: To determine the most recent iDRAC release for your platform and for latest documentation version, see KB article <https://www.dell.com/support/article/sln000178115>.

You can also access iDRAC using command-line protocol - RACADM. For more information, see the *Integrated Dell Remote Access Controller RACADM CLI Guide* available at <https://www.dell.com/idracmanuals>.

You can also access iDRAC using automation tool - Redfish API. For more information, see the *Integrated Dell Remote Access Controller User's Guide Redfish API Guide* available at <https://developer.dell.com>.

Resources to install operating system

If the system is shipped without an operating system, you can install a supported operating system by using one of the resources provided in the table below. For information about how to install the operating system, see the documentation links provided in the table below.

Table 32. Resources to install the operating system

Resource	Documentation links
iDRAC	<i>Integrated Dell Remote Access Controller User's Guide</i> at https://www.dell.com/idracmanuals or for system specific <i>Integrated Dell Remote Access Controller User's Guide</i> , go to https://www.dell.com/poweredgemanuals > Product Support page of your system > Documentation . NOTE: To determine the most recent iDRAC release for your platform and for latest documentation version, see KB article at https://www.dell.com/support/article/sln000178115 .
Lifecycle Controller	<i>Dell Lifecycle Controller User's Guide</i> at https://www.dell.com/idracmanuals or for system specific <i>Dell Lifecycle Controller User's Guide</i> , go to https://www.dell.com/poweredgemanuals > Product Support page of your system > Documentation . Dell recommends using Lifecycle Controller to install the OS, since all required drivers are installed on the system. NOTE: To determine the most recent iDRAC release for your platform and for latest documentation version, see KB article at https://www.dell.com/support/article/sln000178115 .
OpenManage Deployment Toolkit	www.dell.com/openmanagemanuals > OpenManage Deployment Toolkit
Dell certified VMware ESXi	www.dell.com/virtualizationsolutions

NOTE: For more information about installation and how-to videos for operating systems supported on PowerEdge systems, see [Supported Operating Systems for Dell PowerEdge systems](#).

Options to download drivers and firmware

You can download firmware from the Dell support site. For information about downloading firmware, see the [Downloading drivers and firmware](#) section.

You can also choose any one of the following options to download the firmware. For information about how to download the firmware, see the documentation links provided in the table below.

Table 33. Options to download firmware

Option	Documentation link
Using Integrated Dell Remote Access Controller Lifecycle Controller (iDRAC with LC)	www.dell.com/idracmanuals

Table 33. Options to download firmware (continued)

Option	Documentation link
Using Dell Repository Manager (DRM)	www.dell.com/openmanagemanuals > Repository Manager
Using Dell Server Update Utility (SUU)	www.dell.com/openmanagemanuals > Server Update Utility
Using Dell OpenManage Deployment Toolkit (DTK)	www.dell.com/openmanagemanuals > OpenManage Deployment Toolkit
Using iDRAC virtual media	www.dell.com/idracmanuals

Options to download and install OS drivers

You can choose any one of the following options to download and install OS drivers. For information about how to download or install OS drivers, see the documentation links provided in the table below.

Table 34. Options to download and install OS drivers

Option	Documentation
Dell support site	Downloading drivers and firmware section.
iDRAC virtual media	Integrated Dell Remote Access Controller User's Guide or for system specific, go to Integrated Dell Remote Access Controller User's Guide > Product Support page of your system > Documentation .  NOTE: To determine the most recent iDRAC release for your platform and for latest documentation version, see www.dell.com/support/article/sln000178115 .

Downloading drivers and firmware

It is recommended that you download and install the latest BIOS, drivers, and systems management firmware on the system.

Prerequisites

Ensure that you clear the web browser cache before downloading the drivers and firmware.

Steps

1. Go to www.dell.com/support/drivers.
2. Enter the Service Tag of the system in the **Enter a Dell Service Tag, Dell Product ID or Model** field, and then press Enter.

 **NOTE:** If you do not have the Service Tag, click **Browse all products**, and navigate to your product.

3. On the displayed product page, click **Drivers & Downloads**.
On the **Drivers & Downloads** page, all drivers that are applicable to the system are displayed.
4. Download the drivers to a USB drive, CD, or DVD.

Pre-operating system management applications

You can manage basic settings and features of a system without booting to the operating system by using the system firmware.

Options to manage the pre-operating system applications

You can use any one of the following options to manage the pre-operating system applications:

- System Setup
- Dell Lifecycle Controller
- Boot Manager
- Preboot Execution Environment (PXE)

Topics:

- [System Setup](#)
- [Dell Lifecycle Controller](#)
- [Boot Manager](#)
- [PXE boot](#)

System Setup

Using the

System Setup option, you can configure the BIOS settings, iDRAC settings, and device settings of the system.

You can access system setup by using any one of the following interfaces:

- Graphical User interface — To access go to iDRAC Dashboard, click **Configurations > BIOS Settings**.
- Text browser — To enable the text browser, use the Console Redirection.

To view

System Setup, power on the system, press F2, and click **System Setup Main Menu**.

 **NOTE:** If the operating system begins to load before you press F2, wait for the system to finish booting, and then restart the system and try again.

The options on the

System Setup Main Menu screen are described in the following table:

Table 35. System Setup Main Menu

Option	Description
System BIOS	Enables you to configure the BIOS settings.
iDRAC Settings	Enables you to configure the iDRAC settings. The iDRAC settings utility is an interface to set up and configure the iDRAC parameters by using UEFI (Unified Extensible Firmware Interface). You can enable or disable various iDRAC parameters by using the iDRAC settings utility. For more information about this utility, see <i>Integrated Dell Remote Access Controller User's Guide</i> available at https://www.dell.com/idracmanuals .

Table 35. System Setup Main Menu (continued)

Option	Description
Device Settings	Enables you to configure device settings for devices such as storage controllers or network cards.
Service Tag Settings	Enables you to configure the System Service Tag.

System BIOS

To view the **System BIOS** screen, power on the system, press F2, and click **System Setup Main Menu > System BIOS**.

Table 36. System BIOS details

Option	Description
System Information	Provides information about the system such as the system model name, BIOS version, and Service Tag.
Memory Settings	Specifies information and options related to the installed memory.
Processor Settings	Specifies information and options related to the processor such as speed and cache size.
SATA Settings	Specifies options to enable or disable the embedded SATA controller and ports.
NVMe Settings	Specifies options to change the NVMe settings. If the system contains the NVMe drives that you want to configure in a RAID array, you must set both this field and the Embedded SATA field on the SATA Settings menu to RAID mode. You might also need to change the Boot Mode setting to UEFI . Otherwise, you should set this field to Non-RAID mode.
Boot Settings	Specifies options to specify the Boot mode (BIOS or UEFI). Enables you to modify UEFI and BIOS boot settings.
Network Settings	Specifies options to manage the UEFI network settings and boot protocols. Legacy network settings are managed from the Device Settings menu.  NOTE: Network Settings are not supported in BIOS boot mode.
Integrated Devices	Specifies options to manage integrated device controllers and ports, specifies related features, and options.
Serial Communication	Specifies options to manage the serial ports, its related features, and options.
System Profile Settings	Specifies options to change the processor power management settings, memory frequency.
System Security	Specifies options to configure the system security settings, such as system password, setup password, Trusted Platform Module (TPM) security, and UEFI secure boot. It also manages the power button on the system.
Redundant OS Control	Sets the redundant OS information for redundant OS control.
Miscellaneous Settings	Specifies options to change the system date and time.

System Information

To view the **System Information** screen, power on the system, press F2, and click **System Setup Main Menu > System BIOS > System Information**.

Table 37. System Information details

Option	Description
System Model Name	Specifies the system model name.

Table 37. System Information details (continued)

Option	Description
System BIOS Version	Specifies the BIOS version installed on the system.
System Management Engine Version	Specifies the current version of the Management Engine firmware.
System Service Tag	Specifies the system Service Tag.
System Manufacturer	Specifies the name of the system manufacturer.
System Manufacturer Contact Information	Specifies the contact information of the system manufacturer.
System CPLD Version	Specifies the current version of the system Complex Programmable Logic Device (CPLD) firmware.
Secondary System CPLD Version	Specifies the current version of the PEM board Complex Programmable Logic Device (CPLD) firmware.
UEFI Compliance Version	Specifies the UEFI compliance level of the system firmware.

Memory Settings

To view the **Memory Settings** screen, power on the system, press F2, and click **System Setup Main Menu > System BIOS > Memory Settings**.

Table 38. Memory Settings details

Option	Description
System Memory Size	Specifies the size of the system memory.
System Memory Type	Specifies the type of memory installed in the system.
System Memory Speed	Specifies the speed of the system memory.
Video Memory	Specifies the size video memory.
System Memory Testing	Specifies whether the system memory tests are run during system boot. The two options available are Enabled and Disabled . This option is set to Disabled by default.
Memory Operating Mode	This field selects the memory operating mode. This feature is active only if a valid memory configuration is detected. When Optimizer Mode is enabled, the DRAM controllers operate independently in 64-bit mode and provide optimized memory performance. When Dell Fault Resilient Mode (FRM) is enabled, a percentage of the total installed memory is configured to create a fault resilient zone starting from lowest system memory address for use by select hypervisors for host virtualization resilience. Specify the FRM percentage by using the Fault Resilient Mode Memory Size[%] feature. When Dell NUMA Fault Resilient Mode (FRM) is enabled, a percentage of the installed memory in every NUMA node is configured to create a fault resilient zone for use by select hypervisors for host virtualization resilience. Specify the FRM percentage by using the Fault Resilient Mode Memory Size[%] feature.
Current State of Memory Operating Mode	Specifies the current state of the memory operating mode.
Fault Resilient Mode Memory Size[%]	Select to define the percent of total memory size that must be used by the fault resilient mode, when selected in the Memory Operating mode. When Fault Resilient Mode is not selected, this option is grayed out and not used by Fault Resilient Mode.
Node Interleaving	Enables or disables the Node interleaving option. Specifies if the Non-Uniform Memory Architecture (NUMA) is supported. If this field is set to Enabled , memory interleaving is supported if a symmetric memory configuration is installed. If the field is set to Disabled , the system supports NUMA (asymmetric) memory configurations. This option is set to Disabled by default.

Table 38. Memory Settings details (continued)

Option	Description
ADDDC Setting	Enables or disables ADDDC Setting feature. When Adaptive Double DRAM Device Correction (ADDDC) is enabled, failing DRAM's are dynamically mapped out. When set to Enabled , it can have some impact to system performance under certain workloads. This feature is applicable for x4 DIMMs only. This option is set to Enabled by default.
Memory training	<p>When option is set to Fast and memory configuration is not changed, the system uses previously saved memory training parameters to train the memory subsystems and system boot time is also reduced. If memory configuration is changed, the system automatically enables Retrain at Next boot to force one-time full memory training steps, and then go back to Fast afterward.</p> <p>When option is set to Retrain at Next boot, the system performs the force one-time full memory training steps at next power on and boot time is slowed on next boot.</p> <p>When option is set to Enable, the system performs the force full memory training steps on every power on and boot time is slowed on every boot.</p>
DIMM Self Healing (Post Package Repair) on Uncorrectable Memory Error	Enables or disables Post Packing Repair (PPR) on uncorrectable memory error. This option is set to Enabled by default.
Correctable Error Logging	Enables or disables correctable error logging. This option is set to Disabled by default.
Memory Map Out	This option controls DIMMs slots on the system. This option is set to Enabled by default. It allows to disable system installed DIMMs.

Processor Settings

To view the **Processor Settings** screen, power on the system, press F2, and click **System Setup Main Menu > System BIOS > Processor Settings**.

Table 39. Processor Settings details

Option	Description
Logical Processor	Each processor core supports up to two logical processors. If this option is set to Enabled , the BIOS displays all the logical processors. If this option is set to Disabled , the BIOS displays only one logical processor per core. This option is set to Enabled by default.
CPU Interconnect Speed	<p>Enables you to govern the frequency of the communication links among the processors in the system.</p> <p>NOTE: The standard and basic bin processors support lower link frequencies.</p> <p>The options available are Maximum data rate, 16 GT/s, 14.4 GT/s, and 12.8 GT/s. This option is set to Maximum data rate by default.</p> <p>Maximum data rate indicates that the BIOS runs the communication links at the maximum frequency supported by the processors. You can also select specific frequencies that the processors support, which can vary.</p> <p>For best performance, you should select Maximum data rate. Any reduction in the communication link frequency affects the performance of non-</p>

Table 39. Processor Settings details (continued)

Option	Description
	<p>local memory access and cache coherency traffic. In addition, it can slow access to non-local I/O devices from a particular processor.</p> <p>However, if power saving considerations outweigh performance, reduce the frequency of the processor communication links. Before reducing the frequency, you must localize the memory and I/O access to the nearest NUMA node to minimize the impact to system performance.</p>
Virtualization Technology	Enables or disables the virtualization technology for the processor. This option is set to Enabled by default.
Kernel DMA Protection	This option is set to Disabled by default. When option is set to Enabled , BIOS and Operating System will enable direct memory access protection for DMA capable peripheral devices using virtualization technology.
Directory Mode	Enables or disables the directory mode. This option is set to Enabled by default.
Adjacent Cache Line Prefetch	Optimizes the system for applications that need high utilization of sequential memory access. This option is set to Enabled by default. You can disable this option for applications that need high utilization of random memory access.
Hardware Prefetcher	Enables or disables the hardware prefetcher. This option is set to Enabled by default.
DCU Streamer Prefetcher	Enables or disables the Data Cache Unit (DCU) streamer prefetcher. This option is set to Enabled by default.
DCU IP Prefetcher	Enables or disables the Data Cache Unit (DCU) IP prefetcher. This option is set to Enabled by default.
Sub NUMA Cluster	Enables or disables the Sub NUMA Cluster. This option is set to Disabled by default.
MADT Core Enumeration	Specifies the MADT Core Enumeration. This option is set to default in Round Robin . Linear option supports industry core enumeration whereas, Round Robin option supports Dell optimized core enumeration.
UMA Based Clustering	It is a read-only field and displays as Quadrant , when Sub NUMA Cluster is disabled or displays as Disabled , when Sub NUMA Cluster is either 2-way or 4-way.
UPI Prefetch	Enables you to get the memory read started early on DDR bus. The Ultra Path Interconnect (UPI) Rx path spawns the speculative memory that is read to Integrated Memory Controller (iMC) directly. This option is set to Enabled by default.
XPT Prefetch	This option is set to Enabled by default.
LLC Prefetch	Enables or disables the LLC Prefetch on all threads. This option is set to Enabled by default.
Dead Line LLC Alloc	Enables or disables the Dead Line LLC Alloc. This option is set to Enabled by default. You can enable this option to enter the dead lines in LLC or disable the option to not enter the dead lines in LLC.
Directory AtoS	Enables or disables the Directory AtoS. AtoS optimization reduces remote read latencies for repeat read accesses without intervening writes. This option is set to Disabled by default.

Table 39. Processor Settings details (continued)

Option	Description
AVX P1	<p>Enables you to reconfigure the processor Thermal Design Power (TDP) levels during POST based on the power and thermal delivery capabilities of the system. TDP verifies the maximum heat the cooling system is must dissipate. This option is set to Normal by default.</p> <p>NOTE: This option is only available on certain stock keeping units (SKUs) of the processors.</p>
Intel SST-BF	<p>Enables Intel SST-BF. This option is displayed if Performance Per Watt (operating system) or Custom (when OSPM is enabled) system profiles are selected. This option is set to Disabled by default.</p>
Intel SST-CP	<p>Enables Intel SST-CP. This option is displayed if Performance Per Watt (operating system) or Custom (when OSPM is enabled) system profiles are selected. This option is displayed and selectable for each system profile mode. This option is set to Disabled by default.</p>
Optimized Power Mode	<p>When set to Enabled, processor is turned for lower power consumption.</p> <p>Also sets C1E to Enabled, sets CPU Power Management to System DBPM mode, sets Energy Efficient Policy to Performance, and sets Uncore Frequency to Dynamic.</p> <p>This option is set to Disabled by default.</p>
L2 RFO Prefetch	<p>Enable or disable the L2 RFO (Read For Ownership) prefetch. The RFO is the process of reading a cache line from the memory into the cache before it can be written to. This option is set to Enabled by default.</p>
FastGo	<p>Select CR QoS Configuration Profiles. There are 0 to 6 FastGo configuration that Intel provides and the default option is set to configuration 6.</p>
x2APIC Mode	<p>Enables or disables x2APIC mode. This option is set to Enabled by default.</p> <p>NOTE: For two processors 64 cores configuration, x2APIC mode is not switchable if 256 threads are enabled (BIOS settings: All CCD, cores, and logical processors enabled).</p>
AVX ICCP Pre-Grant License	<p>Enables or disables AVX ICCP Pre-Grant License. This option is set to Disabled by default.</p>
Dell Controlled Turbo	
Dell Controlled Turbo Settings	<p>Controls the turbo engagement. Enable this option only when System Profile is set to Performance or Custom, and CPU Power Management is set to Performance. This item can be selected for each system profile mode. This option is set to Disabled by default.</p> <p>NOTE: Depending on the number of installed processors, there might be up to two processor listings.</p>
Dell AVX Scaling Technology	<p>Enables you to configure the Dell AVX scaling technology. This option is set to 0 by default. Enter the value from 0 to 12 bins. The value that is entered decreases the Dell AVX Scaling Technology frequency when the Dell-controlled Turbo feature is enabled.</p>

Table 39. Processor Settings details (continued)



Option	Description
Optimizer Mode	Enables or disables the CPU performance. When this option is set to Auto , set the CPU Power Management to Max Performance. When set to Enabled , enables the CPU Power Management settings. When set to Disabled , the CPU Power Management option is disabled. This option is set to Auto by default.
Number of Cores per Processor	Controls the number of enabled cores in each processor. This option is set to All by default.
CPU Physical Address Limit	Limit CPU physical address to 46 bits to support older Hyper-V. If enabled, automatically disables TME-MT. This option is set to Enabled by default.
AMP Prefetch	This option enables one of the Mid-Level Cache (MLC) AMP hardware Prefetcher. This option is set to Disabled by default.
Homeless Prefetch	This option allows L1 Data Cache Unit (DCU) to prefetch when the Fill Buffers (FB) is full. Auto maps to hardware default setting. This option is set to Auto by default.
Uncore Frequency RAPL	This setting controls whether the Running Average Power Limit (RAPL) balancer is enabled or not. If enabled, it activates the uncore power budgeting. This option is set to Enabled by default.
Processor Core Speed	Specifies the maximum core frequency of the processor.
Processor Bus Speed	Specifies the bus speed of the processor.  NOTE: The processor bus speed option displays only when both processors are installed.
Local Machine Check Exception	Enables or disables the local machine check exception. This is an extension of the MCA Recovery mechanism providing the capability to deliver Uncorrected Recoverable (UCR) Software Recoverable Action Required (SRAR) errors to one or more specific logical processors threads receiving previously poisoned or corrupted data. When enabled, the UCR SRAR Machine Check Exception is delivered only to the affected thread rather than broadcast to all threads in the system. The feature supports operating system recovery for cases of multiple recoverable faults that are detected close, which would otherwise result in a fatal machine check event. The feature is available only on Advanced RAS processors. This option is set to Enabled by default.
CPU Crash Log Support	This field controls Intel CPU Crash Log feature for collection of previous crash data from shared SRAM of Out-of-Band Management Services Module at post reset. This option is set to Disabled by default.
Processor n	 NOTE: Depending on the number of processors, there might be up to n processors listed. The following settings are displayed for each processor:

Table 40. Processor n details

Option	Description
Family-Model-Stepping	Specifies the family, model, and stepping of the processor as defined by Intel.
Brand	Specifies the brand name.

Table 40. Processor n details (continued)

Option	Description
Level 2 Cache	Specifies the total L2 cache.
Level 3 Cache	Specifies the total L3 cache.
Number of Cores	Specifies the number of cores per processor.
Microcode	Specifies the processor microcode version.

SATA Settings

To view the **SATA Settings** screen, power on the system, press F2, and click **System Setup Main Menu > System BIOS > SATA Settings**.

Table 41. SATA Settings details

Option	Description
Embedded SATA	Enables the embedded SATA option to be set to Off , AHCI mode , or RAID mode . This option is set to AHCI Mode by default. i NOTE: <ol style="list-style-type: none"> 1. You might also need to change the Boot Mode setting to UEFI. Otherwise, you should set the field to Non-RAID mode. 2. No ESXi and Ubuntu OS support under RAID mode.
Security Freeze Lock	Sends Security Freeze Lock command to the embedded SATA drives during POST. This option is applicable only for AHCI Mode. This option is set to Enabled by default.
Write Cache	Enables or disables the command for the embedded SATA drives during POST. This option is applicable only for AHCI Mode. This option is set to Disabled by default.
Port n	Sets the drive type of the selected device. For AHCI Mode , BIOS support is always enabled.

Table 42. Port n

Options	Descriptions
Model	Specifies the drive model of the selected device.
Drive Type	Specifies the type of drive attached to the SATA port.
Capacity	Specifies the total capacity of the drive. This field is undefined for removable media devices such as optical drives.

NVMe Settings

This option sets the NVMe drive mode. If the system contains NVMe drives that you want to configure in a RAID array, you must set both this field and the Embedded SATA field on the SATA settings menu to RAID Mode. You may also need to change the Boot Mode setting to UEFI.

To view the **NVMe Settings** screen, power on the system, press F2, and click **System Setup Main Menu > System BIOS > NVMe Settings**.

Table 43. NVMe Settings details

Option	Description
NVMe mode	Enables or disables the boot mode. The option is set to Non-RAID mode by default.
BIOS NVMe Driver	Sets the drive type to boot the NVMe driver. The available options are Dell Qualified Drives and All Drives . This option is set to Dell Qualified Drives by default.

Boot Settings

You can use the **Boot Settings** screen to set the boot mode to either **BIOS** or **UEFI**. It also enables you to specify the boot order. The **Boot Settings** supports both **Legacy** and **UEFI** modes.

- **UEFI:** The Unified Extensible Firmware Interface (UEFI) is a new interface between operating systems and platform firmware. The interface consists of data tables with platform related information, boot and runtime service calls that are available to the operating system and its loader. The following benefits are available when the **Boot Mode** is set to **UEFI**:
 - Support for drive partitions larger than 2 TB.
 - Enhanced security (e.g., UEFI Secure Boot).
 - Faster boot time.

NOTE: You must use only the UEFI boot mode in order to boot from NVMe drives.

- **BIOS:** The **BIOS Boot Mode** is the legacy boot mode. It is maintained for backward compatibility.

To view the **Boot Settings** screen, power on the system, press F2, and click **System Setup Main Menu > System BIOS > Boot Settings**.

Table 44. Boot Settings details

Option	Description
Boot Mode	<p>Enables you to set the boot mode of the system. If the operating system supports UEFI, you can set this option to UEFI. Setting this field to BIOS allows compatibility with non-UEFI operating systems. This option is set to UEFI by default.</p> <p>CAUTION: Switching the boot mode may prevent the system from booting if the operating system is not installed in the same boot mode.</p> <p>NOTE: Setting this field to UEFI disables the BIOS Boot Settings menu.</p>
Boot Sequence Retry	<p>Enables or disables the Boot sequence retry feature or resets the system. When this option is set to Enabled and the system fails to boot, the system re-attempts the boot sequence after 30 seconds. When this option is set to Reset and the system fails to boot, the system reboots immediately. This option is set to Enabled by default.</p>
Hard-disk Failover	<p>Enables or disables the Hard-disk failover. This option is set to Disabled by default.</p>
Generic USB Boot	<p>Enables or disables the generic USB boot placeholder. This option is set to Disabled by default.</p>
Hard-disk Drive Placeholder	<p>Enables or disables the Hard-disk drive placeholder. This option is set to Disabled by default.</p>
Clean all Sysprep variables and order	<p>When this option is set to None, BIOS will do nothing. When set to Yes, BIOS will delete variables of SysPrep ##### and SysPrepOrder this option is a onetime option, will reset to none when deleting variables. This setting is only available in UEFI Boot Mode. This option is set to None by default.</p>
UEFI Boot Settings	<p>Specifies the UEFI boot sequence. Enables or disables UEFI Boot options.</p> <p>NOTE: This option controls the UEFI boot order. The first option in the list will be attempted first.</p>

Table 45. UEFI Boot Settings

Option	Description
UEFI Boot Sequence	<p>Enables you to change the boot device order.</p>
Boot Options Enable/Disable	<p>Enables you to select the enabled or disabled boot devices</p>

Choosing system boot mode

System Setup enables you to specify one of the following boot modes for installing your operating system:

- UEFI boot mode (the default), is an enhanced 64-bit boot interface. If you have configured your system to boot to UEFI mode, it replaces the system BIOS.

1. From the **System Setup Main Menu**, click **Boot Settings**, and select **Boot Mode**.
2. Select the UEFI boot mode you want the system to boot into.

 **CAUTION: Switching the boot mode may prevent the system from booting if the operating system is not installed in the same boot mode.**

3. After the system boots in the specified boot mode, proceed to install your operating system from that mode.

 **NOTE:** Operating systems must be UEFI-compatible to be installed from the UEFI boot mode. DOS and 32-bit operating systems do not support UEFI and can only be installed from the BIOS boot mode.

 **NOTE:** For the latest information about supported operating systems, go to www.dell.com/ossupport.

Changing boot order

About this task

You may have to change the boot order if you want to boot from a USB key or an optical drive. The following instructions may vary if you have selected **BIOS** for **Boot Mode**.

 **NOTE:** Changing the drive boot sequence is only supported in BIOS boot mode.

Steps

1. On the **System Setup Main Menu** screen, click **System BIOS > Boot Settings > UEFI Boot Settings > UEFI Boot Sequence**.
2. Use the arrow keys to select a boot device, and use the plus (+) and minus (-) sign keys to move the device down or up in the order.
3. Click **Exit**, and then click **Yes** to save the settings on exit.

 **NOTE:** You can also enable or disable boot order devices as needed.

Network Settings

To view the **Network Settings** screen, power on the system, press F2, and click **System Setup Main Menu > System BIOS > Network Settings**.

 **NOTE:** Network Settings are not supported in BIOS boot mode.

Table 46. Network Settings details

Option	Description
UEFI PXE Settings	Enables you to control the configuration of the UEFI PXE device.
Number of PXE Devices	This field specifies the number of PXE devices. This option is set to 4 by default.
PXE Device n (n = 1 to 4)	Enables or disables the device. When enabled, a UEFI PXE boot option is created for the device.
PXE Device n Settings (n = 1 to 4)	Enables you to control the configuration of the PXE device.
UEFI HTTP Settings	Enables you to control the configuration of the UEFI HTTP device.
HTTP Device n (n = 1 to 4)	Enables or disables the device. When enabled, a UEFI HTTP boot option is created for the device.
HTTP Device n Settings (n = 1 to 4)	Enables you to control the configuration of the HTTP device.
UEFI iSCSI Settings	Enables you to control the configuration of the iSCSI device.
iSCSI Initiator Name	Specifies the name of the iSCSI initiator in IQN format.
iSCSI Device1	Enables or disables the iSCSI device. When enabled, there is an iSCSI device shown in the Boot Menu. This is set to Disabled by default.
iSCSI Device1 Settings	Enables you to control the configuration of the iSCSI device.

Table 46. Network Settings details (continued)

Option	Description
UEFI NVMe-oF Settings	Enables you to control the configuration of the NVMe-oF devices.
NVMe-oF	Enables or disables the NVMe-oF feature. When enabled, it allows to configure the host and target parameters needed for fabric connection. This is set to Disabled by default.
NVMe-oF Host NQN	This field specifies the name of the NVMe-oF host NQN. Allowed input is in the following format: nqn.yyyy-mm.<Reserved Domain Name>:<Unique String>. Leave it empty to use system generated value with following format: nqn.1988-11.com.dell:<Model name>.<Model number>.<Service Tag>.
NVMe-oF Host Id	This field specifies a 16 bytes value of the NVMe-oF host identifier that uniquely identifies this host with the controller in the NVM subsystem. Allowed input is a hexadecimal-encoded string in this format: 00112233-4455-6677-8899-aabbccddeeff. Leave it empty to use system generated value. A value of all FF is not allowed.
Host Security Key Path	This field specifies the Host security key path.
NVMe-oF SubSystem Settings	This field controls the parameters for the NVMe-oF subsystem n connections.

Table 47. PXE Device n Settings details

Option	Description
Interface	Specifies NIC interface used for the PXE device.
Protocol	Specifies Protocol used for PXE device. This option is set to IPv4 or IPv6 . This option is set to IPv4 by default.
Vlan	Enables Vlan for PXE device. This option is set to Enabled or Disabled . This option is set to Disabled by default.
Vlan ID	Shows the Vlan ID for the PXE device
Vlan Priority	Shows the Vlan Priority for the PXE device.

Table 48. HTTP Device n Settings details

Option	Description
Interface	Specifies NIC interface used for the HTTP device.
Protocol	Specifies Protocol used for HTTP device. This option is set to IPv4 or IPv6 . This option is set to IPv4 by default.
Vlan	Enables Vlan for HTTP device. This option is set to Enable or Disable . This option is set to Disable by default.
Vlan ID	Shows the Vlan ID for the HTTP device
Vlan Priority	Shows the Vlan Priority for the HTTP device.
DHCP	Enables or disables DHCP for this HTTP device. This option is set to Enabled by default.
IP Address	Specifies IP address for the HTTP device.
Subnet Mask	Specifies subnet mask for the HTTP device.
Autoconfiguration	Enables or disables the IPv6Autoconfiguration for the HTTP Device. When set to Enabled, IPv6 Address and Gateway are retrieved from Autoconfiguration mechanism.
Prefix Length	IPv6 Prefix Length (0~127) for this HTTP Device.
IPv6 Address	IPv6 Unicast address for this HTTP Device.
Gateway	Specifies gateway for the HTTP device.

Table 48. HTTP Device n Settings details (continued)

Option	Description
DNS info via DHCP	Enables or disables DNS Information from DHCP. This option is set to Enabled by default.
Primary DNS	Specifies the primary DNS server IP address for the HTTP Device.
Secondary DNS	Specifies the secondary DNS server IP address for the HTTP Device.
URI	Obtain URI from the DHCP server if not specified
TLS Authentication Configuration	Specifies the option for TLS authentication configuration.

Table 49. ISCSI Device1 Settings screen details

Option	Description
Connection 1	Enables or disables the ISCSI connection. This option is set to Disabled by default.
Connection 2	Enables or disables the ISCSI connection. This option is set to Disabled by default.
Connection 1 Settings	Enables you to control the configuration for the ISCSI connection.
Connection 2 Settings	Enables you to control the configuration for the ISCSI connection.
Connection Order	Enables you to control the order for which the ISCSI connections will be attempted.

Table 50. TLS Authentication Configuration screen details

Option	Description
TLS Authentication Mode	View or modify the device's boot TLS Authentication Mode. This option is set to One Way by default. None means the HTTP server and the client will not authenticate each other for this boot.
Root Certificate Configuration	Import, delete, or export the root certificate.

Table 51. NVMe-oF SubSystem Settings screen details

Option	Description
NVMe-oF SubSystem n (n = 1 to 4)	Enables or disables NVMe-oF SubSystem. This option is set to Disabled by default.
NVMe-oF SubSystem n Settings (n = 1 to 4)	Enables you to control the configuration of the NVMe-oF SubSystem, if Enabled .

Table 52. NVMe-oF SubSystem n Settings

Option	Description
Interface	NIC interface used for NVMe-oF connections. This option is set to Embedded NIC 1 Port 1 Partition 1 by default.
Transport Type	This field sets the value of transport type for NVMe-oF connection. This option is set to TCP by default.
Protocol	This field sets the value of protocol type for NVMe-oF connection. This option is set to IPv4 by default.
VLAN	Enables or disables VLAN for this NVMe-oF connections. This option is set to Disabled by default.
VLAN Id	Specifies the VLAN Id for this NVMe-oF connection. This option is set to 1 by default.
VLAN Priority	Specifies the VLAN priority for this NVMe-oF connection. This option is set to 0 by default.

Table 52. NVMe-oF SubSystem n Settings (continued)

Option	Description
Retry Count	Specifies the retry count for this NVMe-oF connection. This option is set to 3 by default.
Timeout	Specifies the timeout for this NVMe-oF connection. This option is set to 10000 by default.
DHCP	Enables and disables the DHCP for this NVMe-oF connection. This option is set to Disabled by default.
Host IP Address	Specifies the Host IP Address for this NVMe-oF connection.
Host Subnet Mask	Specifies the Host Subnet Mask for this NVMe-oF connection.
Host Gateway	Specifies the Host Gateway for this NVMe-oF connection.
NVMe-oF subsystem info via DHCP	Enables and disables the NVMe-oF subsystem's DHCP for this connection. This option is set to Disabled by default.
NVMe-oF subsystem NQN	Specifies the NVMe-oF subsystem's NQN for this connection.
NVMe-oF subsystem Address	Specifies the NVMe-oF subsystem's IP address for this connection.
NVMe-oF subsystem Port	Specifies the NVMe-oF subsystem's port for this connection. If subsystem NQN is empty, this field will be forced to the default Discovery Service port 8009 .
NVMe-oF subsystem NID	Specifies the NamespaceID (NID) for this NVMe-oF connection.
NVMe-oF subsystem Controller ID	Specifies the NVMe-oF subsystem's Controller ID for this connection. This option is set to 0 by default.
Security	Enables or disables the security option for this NVMe-oF connection. This option is set to Disabled by default.
Authentication Type	Specifies the authentication type for this NVMe-oF connection. This option is set to None by default.
Securitykeypath	Specifies the Securitykeypath for this NVMe-oF connection.

Integrated Devices

To view the **Integrated Devices** screen, power on the system, press F2, and click **System Setup Main Menu > System BIOS > Integrated Devices**.

Table 53. Integrated Devices details

Option	Description
User Accessible USB Ports	Configures the user accessible USB ports. Selecting Only Back Ports On disables the front USB ports; selecting All Ports Off disables all front and back USB ports; selecting All Ports Off (Dynamic) disables all front and back USB ports during POST and front ports can be enabled or disabled dynamically by authorized user without resetting the system. This option is set to All Ports On by default.
	The USB keyboard and mouse still function in certain USB ports during the boot process, depending on the selection. After the boot process is complete, the USB ports will be enabled or disabled as per the setting.
Internal USB Port	Enables or disables the internal USB port. This option is set to On or Off . This option is set to On by default.
iDRAC Direct USB Port	The iDRAC Direct USB port is managed by iDRAC exclusively with no host visibility. This option is set to ON or OFF . When set to OFF , iDRAC does not detect any USB devices installed in this managed port. This option is set to On by default.

Table 53. Integrated Devices details (continued)

Option	Description
Integrated Network Card1	Enables or disables the integrated network card. When this option is set to Disabled , the card is not available to the operating system. i NOTE: If set to Disabled (operating system), the Integrated NICs might still be available for shared network access by iDRAC.
Embedded NIC1 and NIC2	Enables or disables the OS interface of the Embedded NIC1 and NIC2 controller. If set to Disabled (OS) , the NIC may still be available for shared network access by the embedded management controller. Configure the Embedded NIC1 and NIC2 option by using the NIC management utilities of the system. This option is set to Enabled by default.
I/OAT DMA Engine	Enables or disables the I/O Acceleration Technology (I/OAT) option. I/OAT is a set of DMA features designed to accelerate network traffic and lower CPU utilization. Enable only if the hardware and software support the feature. This option is set to Disabled by default.
Embedded Video Controller	Enables or disables the use of Embedded Video Controller as the primary display. When set to Enabled , the Embedded Video Controller will be the primary display even if add-in graphic cards are installed. When set to Disabled , an add-in graphics card is used as the primary display. BIOS will output displays to both the primary add-in video and the embedded video during POST and preboot environment. The embedded video will then be disabled right before the operating system boots. This option is set to Enabled by default. i NOTE: When there are multiple add-in graphic cards installed in the system, the first card discovered during PCI enumeration is selected as the primary video. You might have to rearrange the cards in the slots in order to control which card is the primary video.
I/O Snoop HoldOff Response	Selects the number of cycles PCI I/O can withhold snoop requests, from the CPU, to allow time to complete its own write to LLC. This setting can help improve performance on workloads where throughput and latency are critical. The options available are 256 Cycles, 512 Cycles, 1K Cycles, 2K Cycles, 4K Cycles, 8K Cycles, 16K Cycles, 32K Cycles, 64K Cycles and 128K Cycles . This option is set to 2K Cycles by default.
Current State of Embedded Video Controller	Displays the current state of the embedded video controller. The Current State of Embedded Video Controller option is a read-only field. If the Embedded Video Controller is the only display capability in the system (that is, no add-in graphics card is installed), then the Embedded Video Controller is automatically used as the primary display even if the Embedded Video Controller setting is set to Disabled .
SR-IOV Global Enable	Enables or disables the BIOS configuration of Single Root I/O Virtualization (SR-IOV) devices. This option is set to Disabled by default.
OS Watchdog Timer	If your system stops responding, this watchdog timer aids in the recovery of your operating system. When this option is set to Enabled , the operating system initializes the timer. When this option is set to Disabled (the default), the timer does not have any effect on the system.
Empty Slot Unhide	Enables or disables the root ports of all the empty slots that are accessible to the BIOS and operating system. This option is set to Disabled by default.
Slot Disablement	Enables or disables or boot driver disables the available PCIe slots on your system. The slot disablement feature controls the configuration of the PCIe cards installed in the specified slot. Slots must be disabled only when the installed peripheral card prevents booting into the operating system or causes delays in system startup. If the slot is disabled, both the Option ROM and UEFI drivers are disabled. Only slots that are present on the system will be available for control. When this option is set to boot driver disabled, both the Option ROM and UEFI driver from the slot will not run during POST. The system will

Table 53. Integrated Devices details (continued)

Option	Description
	not boot from the card and its pre-boot services will not be available. However, the card is available to the operating system.
	Slot n: Enables or disables or only the boot driver is disabled for the PCIe slot n. This option is set to Enabled by default.
Slot Bifurcation	Auto Discovery Bifurcation Settings allows Platform Default Bifurcation , and Manual bifurcation Control .
	This option is set to Platform Default Bifurcation by default. The slot bifurcation field is accessible when set to Manual bifurcation Control and is grayed out when set to Platform Default Bifurcation .
	NOTE: The slot bifurcation supports on PCIe slot only, does not support slot type from Paddle card to Riser and Slimline connector to Riser.

Serial Communication

To view the **Serial Communication** screen, power on the system, press F2, and click **System Setup Main Menu > System BIOS > Serial Communication**.

NOTE: The serial port is optional for the PowerEdge R960 system. The Serial Communication option is applicable only if the serial COM port is installed in the system.

Table 54. Serial Communication details

Option	Description
Serial Communication	Enables the serial communication options. Selects serial communication devices (Serial Device 1 and Serial Device 2) in BIOS. BIOS console redirection can also be enabled, and the port address can be specified. The options available for System without serial COM port (DB9) are On without Console Redirection , On with Console Redirection , Off . This option is set to Off by default. The options available for System with serial COM port (DB9) are On without Console Redirection , On with Console Redirection via Com1 , On with Console Redirection via Com2 , Off , Auto . This option is set to Auto by default.
Serial Port Address	Enables you to set the port address for serial devices. This option is set to either COM1 or COM2 for the serial device (COM1=0x3F8,COM2=0x2F8)and set to COM1 by default. NOTE: You can use only Serial Device 2 for the Serial Over LAN (SOL) feature. To use console redirection by SOL, configure the same port address for console redirection and the serial device. NOTE: Every time the system boots, the BIOS syncs the serial MUX setting that is saved in iDRAC. The serial MUX setting can independently be changed in iDRAC. Loading the BIOS default settings from within the BIOS setup utility may not always revert the serial MUX setting to the default setting of Serial Device 1.
External Serial Connector	Enables you to associate the External Serial Connector to Serial Device 1 , Serial Device 2 , or the Remote Access Device by using this option. This option is set to Serial Device 1 by default. NOTE: Only Serial Device 2 can be used for Serial Over LAN (SOL). To use console redirection by SOL, configure the same port address for console redirection and the serial device.

Table 54. Serial Communication details (continued)

Option	Description
	<p>i NOTE: Every time the system boots, the BIOS syncs the serial MUX setting saved in iDRAC. The serial MUX setting can independently be changed in iDRAC. Loading the BIOS default settings from within the BIOS setup utility may not always revert this setting to the default setting of Serial Device 1.</p>
Failsafe Baud Rate	Specifies the failsafe baud rate for console redirection. The BIOS attempts to determine the baud rate automatically. This failsafe baud rate is used only if the attempt fails, and the value must not be changed. This option is set to 115200 by default.
Remote Terminal Type	Sets the remote console terminal type. This option is set to VT100/VT220 by default.
Redirection After Boot	Enables or disables the BIOS console redirection when the operating system is loaded. This option is set to Enabled by default.

System Profile Settings

To view the **System Profile Settings** screen, power on the system, press F2, and click **System Setup Main Menu > System BIOS > System Profile Settings**.

Table 55. System Profile Settings details

Option	Description
System Profile	<p>Sets the system profile. If you set the System Profile option to a mode other than Performance Per Watt (DAPC), the BIOS automatically sets the rest of the options. You can only change the rest of the options if the mode is set to Custom. This option is set to Performance Per Watt (DAPC) by default. Other options include Custom, Performance, Performance Per Watt (OS) and Workstation Performance.</p> <p>i NOTE: All the parameters on the system profile setting screen are available only when the System Profile option is set to Custom.</p>
CPU Power Management	Sets the CPU power management. This option is set to System DBPM (DAPC) by default. Other option includes Maximum Performance, OS DBPM .
Memory Frequency	Sets the speed of the system memory. You can select Maximum Performance , Maximum Reliability or a specific speed. This option is set to Maximum Performance by default.
Turbo Boost	Enables or disables the processor to operate in the turbo boost mode. This option is set to Enabled by default.
Energy Efficient Turbo	Energy Efficient Turbo (EET) is a mode of operation where a processor's core frequency is adjusted within the turbo range based on workload. This option is set to Enabled by default.
C1E	Enables or disables the processor to switch to a minimum performance state when it is idle. This option is set to Enabled by default.
C-States	Enables or disables the processor to operate in all available power states. C-States allow the processor to enter lower power states when idle. When set to Enabled (OS controlled) or when set to Autonomous (if hardware controlled is supported), the processor can operate in all available Power States to save power, but may increase memory latency and frequency jitter. This option is set to Enabled by default.
Memory Patrol Scrub	Sets the memory patrol scrub mode. This option is set to Standard by default.
Memory Refresh Rate	Sets the memory refresh rate to either 1x or 2x. This option is set to 1x by default.
Uncore Frequency	Enables you to select the Uncore Frequency option. Dynamic mode enables the processor to optimize power resources across cores and uncores during runtime. The optimization of the uncore frequency to either save power or optimize performance is influenced by the setting of the Energy Efficient Policy option.

Table 55. System Profile Settings details (continued)

Option	Description
Dynamic Load Line Switch	Dynamic Load Line Switch control. Dynamic Link Library (DLL) is a Power Management feature , which dynamically switches to the performance mode during periods of high CPU utilization. Read-only unless System Profile is set to Custom .
Energy Efficient Policy	Enables you to select the Energy Efficient Policy option. The CPU uses the setting to manipulate the internal behavior of the processor and determines whether to target higher performance or better power savings. This option is set to Balanced Performance by default.
Monitor/Mwait	Enables the Monitor/Mwait instructions in the processor. This option is set to Enabled for all system profiles, except Custom by default. <i>i</i> NOTE: This option can be disabled when System Profile is set to Custom . <i>i</i> NOTE: When C-States is set to Enabled in the Custom mode, changing the Monitor/Mwait setting does not impact the system power or performance.
Workload Profile	This option allows the user to specify the targeted workload of a server. It allows optimization of performance based on the workload type. This option is set to Not Configured by default.
CPU Interconnect Bus Link Power Management	Enables or disables the CPU Interconnect Bus Link Power Management. This option is set to Enabled by default.
PCI ASPM L1 Link Power Management	Enables or disables the PCI ASPM L1 Link Power Management . This option is set to Enabled by default.
Workload Configuration	This field controls the Energy Performance Bias settings to allow BIOS to choose a configuration that improve performance on certain workload. Read-only unless System Profile is set to Custom .

System Security

To view the **System Security** screen, power on the system, press F2, and click **System Setup Main Menu > System BIOS > System Security**.

Table 56. System Security details

Option	Description
CPU AES-NI	Improves the speed of applications by performing encryption and decryption by using the Advanced Encryption Standard Instruction Set (AES-NI). This option is set to Enabled by default.
System Password	Sets the system password. This option is read-only if the password jumper is not installed in the system.
Setup Password	Sets the setup password. This option is read-only if the password jumper is not installed in the system.
Password Status	Locks the system password. This option is set to Unlocked by default.

Table 57. TPM 2.0 security information

Option	Description
TPM Information	
TPM Security	<i>i</i> NOTE: The TPM menu is available only when the TPM module is installed. Enables you to control the reporting mode of the TPM. When set to Off, the presence of the TPM is not reported to the OS. When set to On, the presence of the TPM is reported to the OS. The TPM Security option is set to Off by default. When TPM 2.0 is installed, the TPM Security option is set to On or Off . This option is set to Off by default.

Table 57. TPM 2.0 security information (continued)

Option	Description	
TPM Information	Indicates the type of Trusted Platform Module, if present.	
TPM Firmware	Indicates the firmware version of the TPM.	
TPM Hierarchy	<p>Enables, disables, or clears the storage and endorsement hierarchies. When set to Enabled, the storage and endorsement hierarchies can be used.</p> <p>When set to Disabled, the storage and endorsement hierarchies cannot be used.</p> <p>When set to Clear, the storage and endorsement hierarchies are cleared of any values, and then reset to Enabled.</p>	
TPM Advanced Settings	TPM PPI Bypass Provision	When set to Enabled , allows the Operating System to bypass Physical Presence Interface (PPI) prompts when issuing PPI Advanced Configuration and Power interface (ACPI) provisioning operations.
	TPM PPI Bypass Clear	When set to Enabled , allows the Operating System to bypass Physical Presence Interface (PPI) prompts when issuing PPI Advanced Configuration and Power interface (ACPI) provisioning operations.
	TPM2 Algorithm Selection	<p>Allows the user to change the cryptographic algorithms used in the Trusted Platform Module (TPM). The available options are dependent on the TPM firmware.</p> <p>To enable TPM2 Algorithm Selection, Intel(R) TXT technology must be disabled.</p> <p>The TPM2 Algorithm Selection option supports SHA1, SHA128, SHA256, SHA512 and SM3 by detecting the TPM module. This option is set to SHA256 by default.</p>

Table 58. System Security details

Option	Description
Intel(R) TXT	Enables you to set the Intel Trusted Execution Technology (TXT) option. To enable the Intel TXT option, virtualization technology and TPM Security must be enabled with Pre-boot measurements. This option is set to Off by default. It is set On for Secure Launch (Firmware Protection) support on Windows 2022.
Memory Encryption	Enables or disables the Intel Total Memory Encryption (TME) and Multi-Tenant (Intel® TME-MT). When option is set to Disabled , BIOS disables both TME and MK-TME technology. When option is set to Single Key BIOS enables the TME technology. When option is set to Multiple Keys , BIOS enables the TME-MT technology. This option is set to Disabled by default.
Global Memory Integrity	Enables or disables the memory integrity of the system. This option is set to Disabled by default.
TME Encryption Bypass	Allows the option to bypass the Intel Total Memory Encryption. This option is set to Disabled by default.
Intel(R) SGX	Enables you to set the Intel Software Guard Extension (SGX) option. To enable the Intel SGX option, processor must be SGX capable, memory population must be compatible (minimum x8 identical DIMM1 to DIMM8 per CPU socket, not support on persistent memory configuration), memory operating mode must be set at optimizer mode, memory encryption must be enabled and node interleaving must be disabled. This option is set to Off by default. When this option is to Off , BIOS disables the SGX technology. When this option is to On , BIOS enables the SGX technology.
Power Button	Enables or disables the power button on the front of the system. This option is set to Enabled by default.
AC Power Recovery	Sets how the system behaves after AC power is restored to the system. This option is set to Last by default.

Table 58. System Security details (continued)



Option	Description				
	<p> NOTE: The host system will not power on until iDRAC Root of Trust (RoT) is completed, host power on will be delayed by minimum 90 seconds after the AC applied.</p>				
AC Power Recovery Delay	Sets the time delay for the system to power up after AC power is restored to the system. This option is set to Immediate by default. When this option is set to Immediate , there is no delay for power up. When this option is set to Random , the system creates a random delay for power up. When this option is set to User Defined , the system delay time is manually to power up.				
User Defined Delay (120 s to 600 s)	Sets the User Defined Delay option when the User Defined option for AC Power Recovery Delay is selected. The actual AC recovery time needs to add iDRAC root of trust time (around 50 seconds).				
UEFI Variable Access	Provides varying degrees of securing UEFI variables. When set to Standard (the default), UEFI variables are accessible in the operating system per the UEFI specification. When set to Controlled , selected UEFI variables are protected in the environment and new UEFI boot entries are forced to be at the end of the current boot order.				
In-Band Manageability Interface	<p>When set to Disabled, this setting hides the Management Engine's (ME), HECI devices, and the system's IPMI devices from the operating system. This prevents the operating system from changing the ME power capping settings, and blocks access to all in-band management tools. All management should be managed through out-of-band. This option is set to Enabled by default.</p> <p> NOTE: BIOS update requires HECI devices to be operational and DUP updates require IPMI interface to be operational. This setting needs to be set to Enabled to avoid updating errors.</p>				
SMM Security Mitigation	Enables or disables the UEFI SMM security mitigation protections. It is set to Disabled by default.				
Secure Boot	Enables Secure Boot, where the BIOS authenticates each pre-boot image by using the certificates in the Secure Boot Policy. Secure Boot is set to Disabled by default.				
Secure Boot Policy	When Secure Boot policy is set to Standard , the BIOS uses the system manufacturer's key and certificates to authenticate pre-boot images. When Secure Boot policy is set to Custom , the BIOS uses the user-defined key and certificates. Secure Boot policy is set to Standard by default.				
Secure Boot Mode	<p>Configures how the BIOS uses the Secure Boot Policy Objects (PK, KEK, db, dbx).</p> <p>If the current mode is set to Deployed Mode, the available options are User Mode and Deployed Mode. If the current mode is set to User Mode, the available options are User Mode, Audit Mode, and Deployed Mode.</p> <p>Below are the details of different boot modes available in the Secure Boot Mode option.</p> <table border="0" data-bbox="523 1599 1498 1957"> <tr> <td data-bbox="523 1599 734 1727">User Mode</td> <td data-bbox="737 1599 1498 1727">In User Mode, PK must be installed, and BIOS performs signature verification on programmatic attempts to update policy objects. The BIOS allows unauthenticated programmatic transitions between modes.</td> </tr> <tr> <td data-bbox="523 1731 734 1957">Audit mode</td> <td data-bbox="737 1731 1498 1957">In Audit Mode, PK is not present. BIOS does not authenticate programmatic update to the policy objects and transitions between modes. The BIOS performs a signature verification on pre-boot images and logs the results in the image Execution Information Table, but executes the images whether they pass or fail verification. Audit Mode is useful for programmatic determination of a working set of policy objects.</td> </tr> </table>	User Mode	In User Mode , PK must be installed, and BIOS performs signature verification on programmatic attempts to update policy objects. The BIOS allows unauthenticated programmatic transitions between modes.	Audit mode	In Audit Mode , PK is not present. BIOS does not authenticate programmatic update to the policy objects and transitions between modes. The BIOS performs a signature verification on pre-boot images and logs the results in the image Execution Information Table, but executes the images whether they pass or fail verification. Audit Mode is useful for programmatic determination of a working set of policy objects.
User Mode	In User Mode , PK must be installed, and BIOS performs signature verification on programmatic attempts to update policy objects. The BIOS allows unauthenticated programmatic transitions between modes.				
Audit mode	In Audit Mode , PK is not present. BIOS does not authenticate programmatic update to the policy objects and transitions between modes. The BIOS performs a signature verification on pre-boot images and logs the results in the image Execution Information Table, but executes the images whether they pass or fail verification. Audit Mode is useful for programmatic determination of a working set of policy objects.				

Table 58. System Security details (continued)

Option	Description
	<p>Deployed Mode Deployed Mode is the most secure mode. In Deployed Mode, PK must be installed and the BIOS performs signature verification on programmatic attempts to update policy objects. Deployed Mode restricts the programmatic mode transitions.</p>
Secure Boot Policy Summary	Specifies the list of certificates and hashes that secure boot uses to authenticate images.
Secure Boot Custom Policy Settings	Configures the Secure Boot Custom Policy. To enable this option, set the Secure Boot Policy to Custom option.

Creating a system and setup password

Prerequisites

Ensure that the password jumper is enabled. The password jumper enables or disables the system password and setup password features. For more information, see the [System board jumper settings](#) section.

NOTE: If the password jumper setting is disabled, the existing system password and setup password are deleted and you need not provide the system password to boot the system.

Steps

- To enter System Setup, press F2 immediately after turning on or rebooting your system.
- On the **System Setup Main Menu** screen, click **System BIOS > System Security**.
- On the **System Security** screen, verify that **Password Status** is set to **Unlocked**.
- In the **System Password** field, type your system password, and press Enter or Tab.
Use the following guidelines to assign the system password:
 - A password can have up to 32 characters.

A message prompts you to reenter the system password.
- Reenter the system password, and click **OK**.
- In the **Setup Password** field, type your setup password and press Enter or Tab.
A message prompts you to reenter the setup password.
- Reenter the setup password, and click **OK**.
- Press Esc to return to the System BIOS screen. Press Esc again.
A message prompts you to save the changes.

NOTE: Password protection does not take effect until the system reboots.

Using your system password to secure your system

About this task

If you have assigned a setup password, the system accepts your setup password as an alternate system password.

Steps

- Turn on or reboot your system.
- Type the system password and press Enter.

Next steps

When **Password Status** is set to **Locked**, type the system password and press Enter when prompted at reboot.

NOTE: If an incorrect system password is typed, the system displays a message and prompts you to reenter your password. You have three attempts to type the correct password. After the third unsuccessful attempt, the system displays an error

message that the system has stopped functioning and must be turned off. Even after you turn off and restart the system, the error message is displayed until the correct password is entered.

Deleting or changing system and setup password

Prerequisites

NOTE: You cannot delete or change an existing system or setup password if the **Password Status** is set to **Locked**.

Steps

1. To enter System Setup, press F2 immediately after turning on or restarting your system.
2. On the **System Setup Main Menu** screen, click **System BIOS > System Security**.
3. On the **System Security** screen, ensure that **Password Status** is set to **Unlocked**.
4. In the **System Password** field, alter or delete the existing system password, and then press Enter or Tab.
5. In the **Setup Password** field, alter or delete the existing setup password, and then press Enter or Tab.
If you change the system and setup password, a message prompts you to reenter the new password. If you delete the system and setup password, a message prompts you to confirm the deletion.
6. Press Esc to return to the **System BIOS** screen. Press Esc again, and a message prompts you to save the changes.
7. Select **Setup Password**, change, or delete the existing setup password and press Enter or Tab.

NOTE: If you change the system password or setup password, a message prompts you to reenter the new password. If you delete the system password or setup password, a message prompts you to confirm the deletion.

Operating with setup password enabled

If **Setup Password** is set to **Enabled**, type the correct setup password before modifying the system setup options.

If you do not type the correct password in three attempts, the system displays the following message:

```
Invalid Password! Number of unsuccessful password attempts: <x> System Halted! Must power down.
```

Even after you power off and restart the system, the error message is displayed until the correct password is typed. The following options are exceptions:

- If **System Password** is not set to **Enabled** and is not locked through the **Password Status** option, you can assign a system password. For more information, see the System Security Settings screen section.
- You cannot disable or change an existing system password.

NOTE: You can use the password status option with the setup password option to protect the system password from unauthorized changes.



Redundant OS Control

To view the **Redundant OS Control** screen, power on the system, press F2, and click **System Setup Main Menu > System BIOS > Redundant OS Control**.

Table 59. Redundant OS Control details

Option	Description
Redundant OS Location	Enables you to select a backup disk from the following devices: <ul style="list-style-type: none">• None• SATA Ports in AHCI mode• BOSS PCIe Cards (Internal M.2 Drives)• Internal USB NOTE: RAID configurations and NVMe cards are not included, as BIOS does not have the ability to distinguish between individual drives in those configurations.



Table 59. Redundant OS Control details (continued)

Option	Description
	<ul style="list-style-type: none"> • Internal SD card
Redundant OS State	<p> NOTE: This option is disabled if Redundant OS Location is set to None.</p> <p>When set to Visible, the backup disk is visible to the boot list and OS. When set to Hidden, the backup disk is disabled and is not visible to the boot list and OS. This option is set to Visible by default.</p> <p> NOTE: BIOS disables the device in hardware, so it is not accessed by the OS.</p>
Redundant OS Boot	<p> NOTE: This option is disabled if Redundant OS Location is set to None or if Redundant OS State is set to Hidden.</p> <p>When set to Enabled, BIOS boots to the device specified in Redundant OS Location. When set to Disabled, BIOS preserves the current boot list settings. This option is set to Disabled by default.</p>

Miscellaneous Settings

To view the **Miscellaneous Settings** screen, power on the system, press F2, and click **System Setup Main Menu > System BIOS > Miscellaneous Settings**.

Table 60. Miscellaneous Settings details

Option	Description
System Time	Enables you to set the time on the system.
System Date	Enables you to set the date on the system.
Time Zone	Enables you to select required Time Zone.
Daylight Savings Time	Enables or disables Daylight Savings Time. This option is set to Disabled by default.
Asset Tag	Specifies the asset tag and enables you to modify it for security and tracking purposes.
Keyboard NumLock	Enables you to set whether the system boots with the NumLock enabled or disabled. This option is set to On by default.  NOTE: This option does not apply to 84-key keyboards.
F1/F2 Prompt on Error	Enables or disables the F1/F2 prompt on error. This option is set to Enabled by default. The F1/F2 prompt also includes keyboard errors.
Load Legacy Video Option ROM	This option determines whether the system BIOS will load legacy video (INT 10h) option ROM from the video controller. This option is set to Disabled by default.  NOTE: This option cannot be set to Enabled, when the Boot mode is UEFI and Secure Boot is enabled.
Dell Wyse P25/P45 BIOS Access	Enables or disables the Dell Wyse P25/P45 BIOS Access. This option is set to Enabled by default.
Power Cycle Request	Enables or disables the Power Cycle Request. This option is set to None by default.

iDRAC Settings

The iDRAC settings is an interface to set up and configure the iDRAC parameters by using UEFI. You can enable or disable various iDRAC parameters by using the iDRAC settings.

 **NOTE:** Accessing some of the features on the iDRAC settings needs the iDRAC Enterprise License upgrade.

For more information about using iDRAC, see *Dell Integrated Dell Remote Access Controller User's Guide* at <https://www.dell.com/idracmanuals>.

Device Settings

Device Settings enables you to configure device parameters such as storage controllers or network cards.

Service Tag Settings

Service Tag Settings enables you to configure the System Service Tag.

Dell Lifecycle Controller

Dell Lifecycle Controller (LC) provides advanced embedded systems management capabilities including system deployment, configuration, update, maintenance, and diagnosis. LC is delivered as part of the iDRAC out-of-band solution and Dell system embedded Unified Extensible Firmware Interface (UEFI) applications.

Embedded system management

The Dell Lifecycle Controller provides advanced embedded system management throughout the lifecycle of the system. The Dell Lifecycle Controller is started during the boot sequence and functions independently of the operating system.

 **NOTE:** Certain platform configurations may not support the full set of features provided by the Dell Lifecycle Controller.

For more information about setting up the Dell Lifecycle Controller, configuring hardware and firmware, and deploying the operating system, see the Dell Lifecycle Controller documentation at <https://www.dell.com/idracmanuals>.

Boot Manager

The **Boot Manager** option enables you to select boot options and diagnostic utilities.

To enter **Boot Manager**, power on the system and press F11.

Table 61. Boot Manager details

Option	Description
Continue Normal Boot	The system attempts to boot to devices starting with the first item in the boot order. If the boot attempt fails, the system continues with the next item in the boot order until the boot is successful or no more boot options are found.
One-shot Boot Menu	Enables you to access boot menu, where you can select a one-time boot device to boot from.
Launch System Setup	Enables you to access System Setup.
Launch Lifecycle Controller	Exits the Boot Manager and invokes the Dell Lifecycle Controller program.
System Utilities	Enables you to launch System Utilities menu such as Launch Diagnostics, BIOS update File Explorer, Reboot System.

PXE boot

You can use the Preboot Execution Environment (PXE) option to boot and configure the networked systems remotely.

To access the **PXE boot** option, boot the system and then press F12 during POST instead of using standard Boot Sequence from BIOS Setup. It does not pull any menu or allows managing of network devices.

Minimum to POST and system management configuration validation

This section describes the minimum to POST system requirement and system management configuration validation of the Dell system.

Topics:

- [Minimum configuration to POST](#)
- [Configuration validation](#)

Minimum configuration to POST

The components that are listed below are the minimum configuration to POST:

- Two same processors in processor socket 1 and socket 2
- Two same memory modules (DIMM) in slot A1 and B1
- One power supply unit
- System board + LOM/OCP card + RIO card

Configuration validation

The new generation of Dell systems have added interconnect flexibility and advanced iDRAC management features to collect precise system configuration information and report configuration errors.

When the system is powered on, information about installed cables, risers, backplanes, power supplies, floating card (fPERC, , BOSS), and processor is obtained from the CPLD and backplane memory maps are analyzed. This information forms a unique configuration, which is compared with one of the qualified configurations that are stored in a table that is maintained by iDRAC.

One or more sensors are assigned to each of the configuration elements. During POST, any configuration validation error is logged in the System Event Log (SEL)/LifeCycle (LC) log. The reported events are categorized in the configuration validation error table.

Table 62. Configuration validation error

Error	Description	Possible cause and recommendations	Example
Config Error	A configuration element within the closest match contains something that is unexpected and does not match any Dell qualified configuration.	Wrong configuration	Config Error: Backplane cable CTRS_SRC_SA1 and BP-DST_SA1
		The element reported in HWC8010 errors are assembled incorrectly. Verify element (cable, risers, etc) placement in the system.	Config Error : SL Cable PLANAR_SL7 and CTRL_DST_PA1
Config Missing	iDRAC found a configuration element missing within the closest match detected.	Missing or damaged cable, device, or part	Config Missing: Float card front PERC/HBAadapter PERC/HBA
		Missing element or cable is reported in HWC8010 error logs. Install the missing element (cable, risers, etc).	Config Missing : SL cable PLANAR_SL8 and CTRL_DST_PA1

Table 62. Configuration validation error (continued)

Error	Description	Possible cause and recommendations	Example
Comm Error	A configuration element is not responding to iDRAC using the management interface while running an inventory check.	System management sideband communication Unplug AC Power, reset the element and replace the element if the problem persists.	Comm Error: Backplane 2

Error messages

This section describes the error messages that are displayed on the screen during POST or captured in the system event log (SEL)/LifeCycle (LC) log.

Table 63. Error message HWC8010

Error code	HWC8010
Message	The System Configuration Check operation that is resulted in the following issue involving the indicated component type
Arguments	Riser, floating card (fPERC, BOSS), backplane, processor, cable, or other components
Detailed Description	The issue that is identified in the message is observed in the System Configuration Check operation.
Recommended Response Action	Do the following and retry the operation: <ol style="list-style-type: none"> 1. Disconnect the input power. 2. Check for proper cable connection and component placement. If the issue persists, contact the service provider.
Category	System Health (HWC = Hardware Config)
Severity	Critical
Trap/EventID	2329

Table 64. Error message HWC8011

Error code	HWC8011
Message	The System Configuration Check operation that is resulted in multiple issues involving the indicated component type
Arguments	Riser, floating card (fPERC, BOSS), backplane, processor, cable, or other components
Detailed Description	Multiple issues are observed in the System Configuration Check operation.
Recommended Response Action	Do the following and retry the operation: <ol style="list-style-type: none"> 1. Disconnect the input power. 2. Check for proper cable connection and component placement. If the issue persists, contact the service provider.
Category	System Health (HWC = Hardware Config)
Severity	Critical

Installing and removing system components

Topics:

- Safety instructions
- Before working inside your system
- After working inside your system
- Recommended tools
- Optional front bezel
- System cover
- Support bar
- Cooling fans
- Air shrouds
- Drives
- Drive backplane
- Side wall brackets
- Cable routings
- PERC module
- EDSFF E3.S backplane module
- System memory
- Expansion cards and expansion card risers
- Power distribution board
- Processor and heat sink module
- Processor expansion module
- PEM power board
- Optional BOSS-N1 module
- System battery
- Optional internal USB card
- Intrusion switch
- Optional OCP card
- Power supply unit
- Trusted Platform Module
- System board
- LOM card, MIC card, and rear I/O board
- Control panel

Safety instructions

 **NOTE:** Whenever you need to lift the system, get others to assist you. To avoid injury, do not attempt to lift the system by yourself.

 **CAUTION:** Ensure that two or more people lift the system horizontally from the box and place it on a flat surface, rack lift, or into the rails.

 **WARNING:** Opening or removing the system cover while the system is powered on may expose you to a risk of electric shock.

 **WARNING:** Do not operate the system without the cover for a duration exceeding five minutes. Operating the system without the system cover can result in component damage.

 **CAUTION:** Many repairs may only be done by a certified service technician. You should only perform troubleshooting and simple repairs as authorized in your product documentation, or as directed by the online or

telephone service and support team. Damage due to servicing that is not authorized by Dell is not covered by your warranty. Read and follow the safety instructions that are shipped with your product.

NOTE: It is recommended that you always use an antistatic mat and antistatic strap while working on components inside the system.

CAUTION: To ensure proper operation and cooling, all system bays and fans must always be populated with a component or a blank.

NOTE: While replacing the hot swappable PSU, after next server boot, the new PSU automatically updates to the same firmware and configuration of the replaced one. For updating to the latest firmware and changing the configuration, see the *Lifecycle Controller User's Guide* at <https://www.dell.com/idracmanuals>.

NOTE: While replacing faulty storage controller, FC, or NIC card with the same type of card, after you power on the system, the new card automatically updates to the same firmware and configuration of the faulty one. For updating to the latest firmware and changing the configuration, see the *Lifecycle Controller User's Guide* at <https://www.dell.com/idracmanuals>.

Before working inside your system

Prerequisites

Follow the safety guidelines listed in the [Safety instructions](#).

Steps

1. Power off the system and all attached peripherals.
2. Disconnect the system from the electrical outlet and disconnect the peripherals.
3. If applicable, remove the system from the rack.
For more information, see the *Rail Installation Guide* relevant to your rail solutions at www.dell.com/poweredge manuals.
4. Remove the system cover.

After working inside your system

Prerequisites

Follow the safety guidelines listed in [Safety instructions](#).

Steps

1. Replace the system cover.
2. If applicable, install the system into the rack.
For more information, see the *Rail Installation Guide* relevant to your system at www.dell.com/poweredge manuals.
3. Reconnect the peripherals and connect the system to the electrical outlet, and then power on the system.

Recommended tools

You may need some or all of the following tools to perform the removal and installation procedures:

- Key to the bezel lock. The key is required only if your system includes a bezel.
- Phillips 1 screwdriver
- Phillips 2 screwdriver
- Torx T30 screwdriver
- 5 mm hex nut screwdriver
- Plastic scribe
- 1/4-inch flat blade screwdriver
- Wrist grounding strap connected to the ground

- ESD mat
- Needle-nose pliers

You need the following tools to assemble the cables for a DC power supply unit:

- AMP 90871-1 hand-crimping tool or equivalent
- Tyco Electronics 58433-3 or equivalent
- Wire-stripper pliers to remove insulation from size 10 AWG solid or stranded, insulated copper wire

NOTE: Use alpha wire part number 3080 or equivalent (65/30 stranding).

Optional front bezel

NOTE: LCD panel is optional on the front bezel. If the front bezel has an LCD panel, see [LCD panel](#) section.

Removing the front bezel

The procedure to remove the front bezel with and without the LCD panel is the same.

Prerequisites

1. Follow the safety guidelines listed in the [Safety instructions](#).
2. Keep the bezel key handy.

NOTE: The bezel key is part of the LCD bezel package.

Steps

1. Unlock the bezel.
2. Press the release button, and disengage the left end of the bezel.
3. Unhook the right end, and remove the bezel.



Figure 30. Removing the front bezel with the LCD panel

Next steps

Replace front bezel.

Installing the front bezel

The procedure to install the front bezel with and without the LCD panel is the same.

Prerequisites

1. Follow the safety guidelines listed in the [Safety instructions](#).
2. Locate and remove the bezel key.

i **NOTE:** The bezel key is part of the LCD bezel package.

Steps

1. Align and insert the tabs on the bezel into the slots on the system.
2. Press the bezel until the release button clicks in place.
3. Lock the bezel.

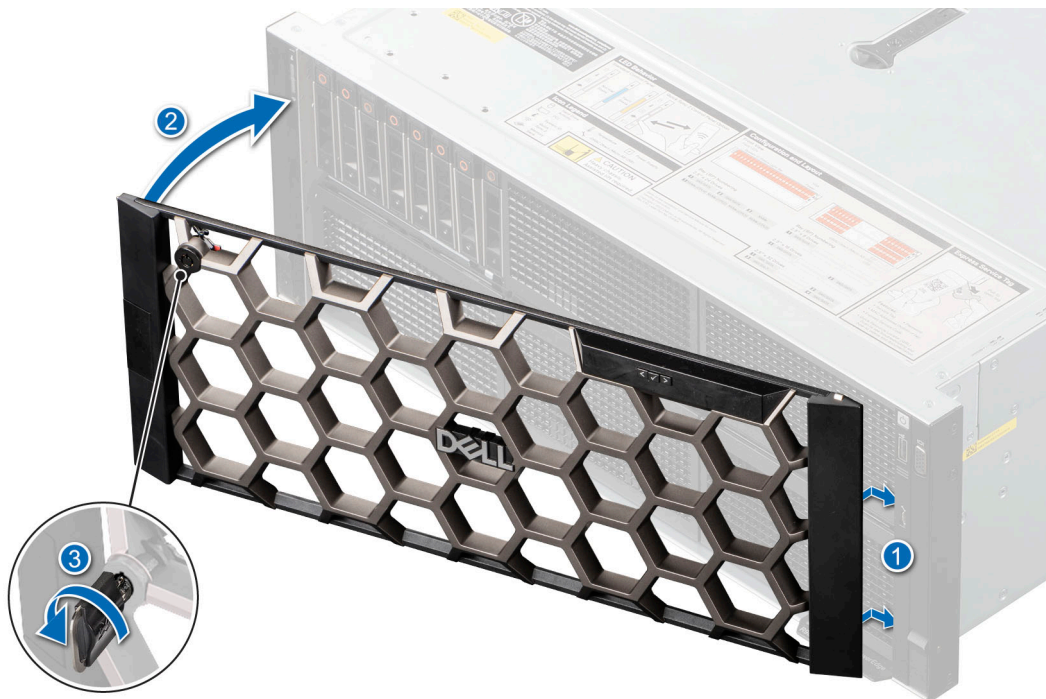

Figure 31. Installing the front bezel with the LCD panel

System cover

Removing the system cover

Prerequisites

1. Follow the safety guidelines listed in the [Safety instructions](#).
2. Power off the system, and any attached peripherals.
3. Disconnect the system from the electrical outlet and peripherals.

Steps

1. Using a 1/4-inch flat head or a Phillips #2 screwdriver, rotate the lock counterclockwise to the unlock position.
2. Lift the release latch until the system cover slides back.
3. Lift the cover from the system.



Figure 32. Removing the system cover

Next steps

1. [Replace the system cover.](#)

Installing the system cover

Prerequisites

1. Follow the safety guidelines listed in the [Safety instructions](#).
2. Follow the procedure listed in [Before working inside your system](#).
3. Ensure that all internal cables are connected and routed properly, and no tools or extra parts are left inside the system.

Steps

1. Align the tabs on the system cover with the guide slots on the system and slide the system cover.
2. Close the system cover release latch.
3. Using a 1/4-inch flat head or Phillips #2 screwdriver, rotate the lock clockwise to the lock position.



Figure 33. Installing the system cover

Next steps

1. Follow the procedure listed in [After working inside your system.](#)

Support bar

Removing the support bar

Prerequisites

1. Follow the safety guidelines listed in the [Safety instructions.](#)
2. Follow the procedure listed in [Before working inside your system.](#)

⚠ CAUTION: The support bar must be removed before removing the air shroud.

Steps

1. Pull the plunger and rotate to lock the plunger on the support bar.
2. If full-length risers are installed, and then loosen the captive screws on the support bar that hold the risers.
3. Lift the support bar from the system.

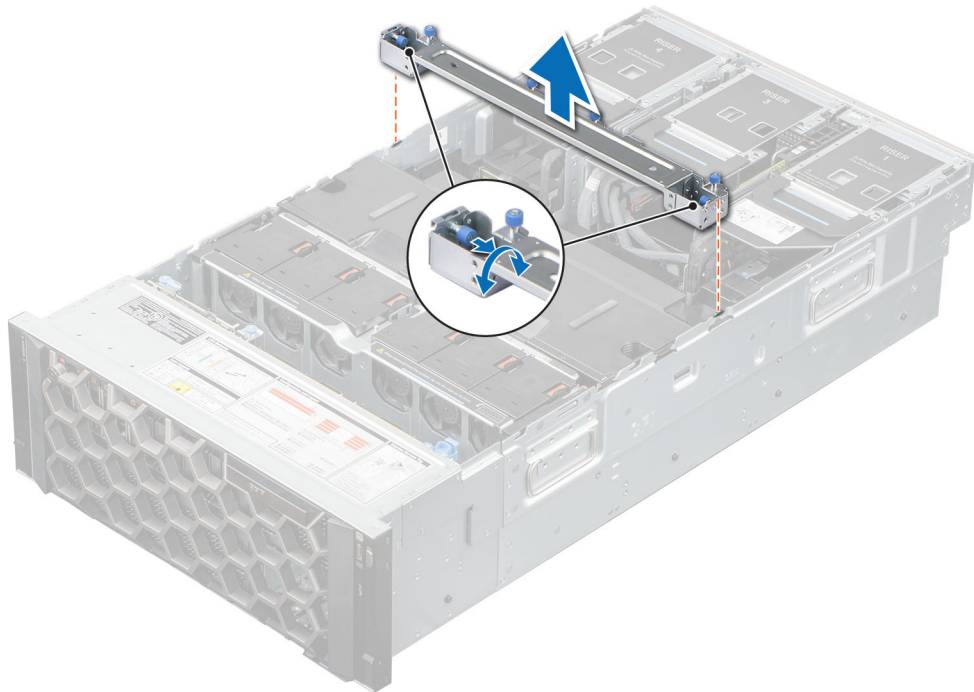

Figure 34. Removing the support bar with half length risers

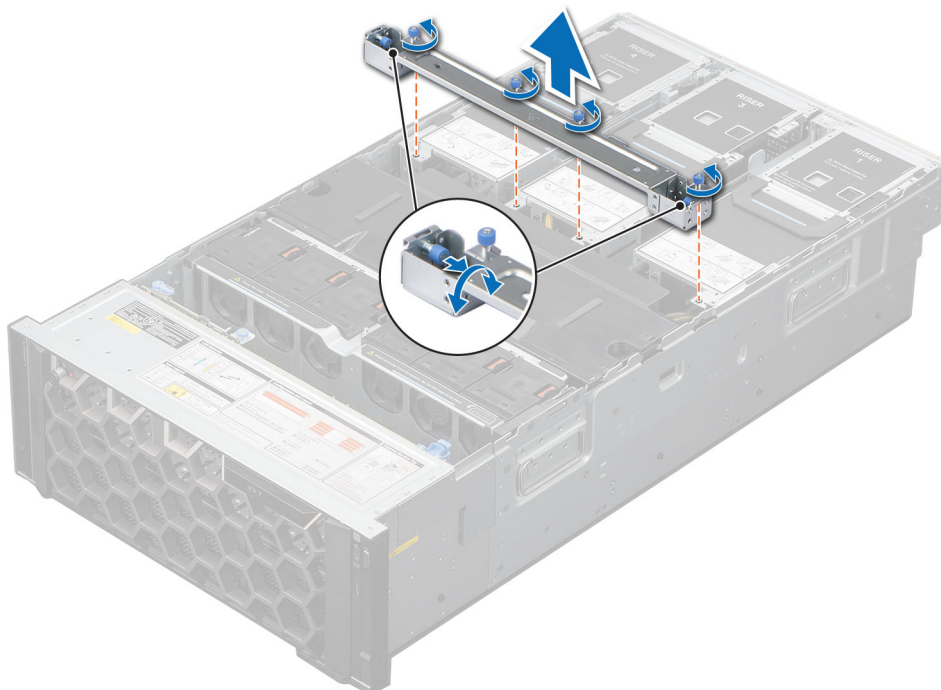

Figure 35. Removing the support bar with full length risers

Next steps

1. [Replace the support bar.](#)

Installing the support bar

Prerequisites

1. Follow the safety guidelines listed in the [Safety instructions](#).
2. Follow the procedure listed in [Before working inside your system](#).

Steps

1. Lower and align the support bar tabs with the guide slots on the system.
2. Rotate the plunger to the lock support bar into the system.
3. If full-length risers are installed, and then tighten the captive screws on the support bar that hold the risers.

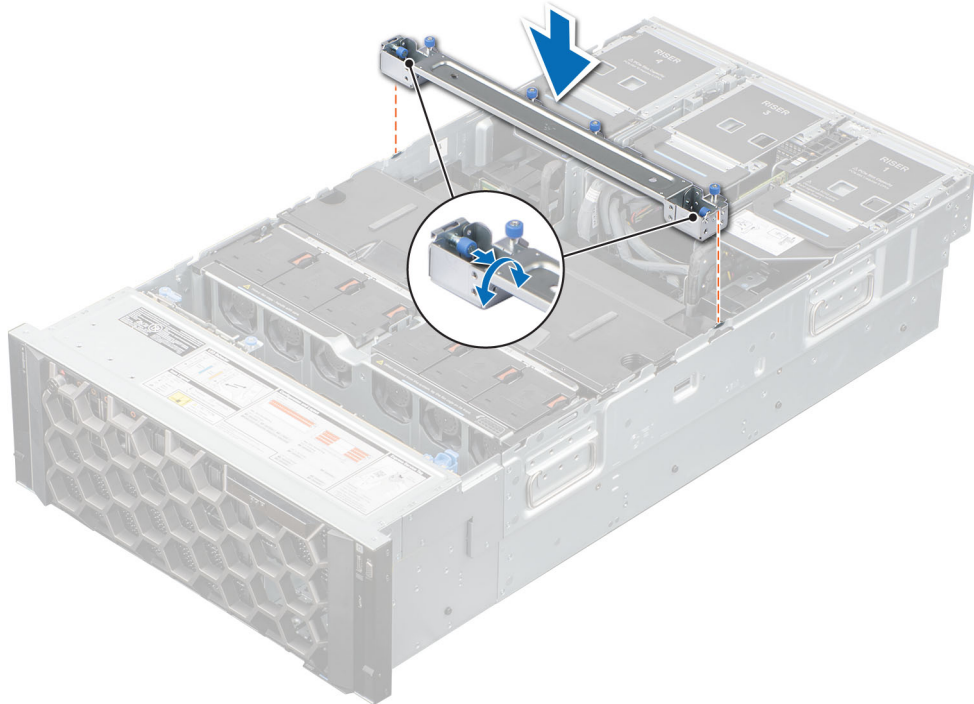

Figure 36. Installing the support bar with half length risers

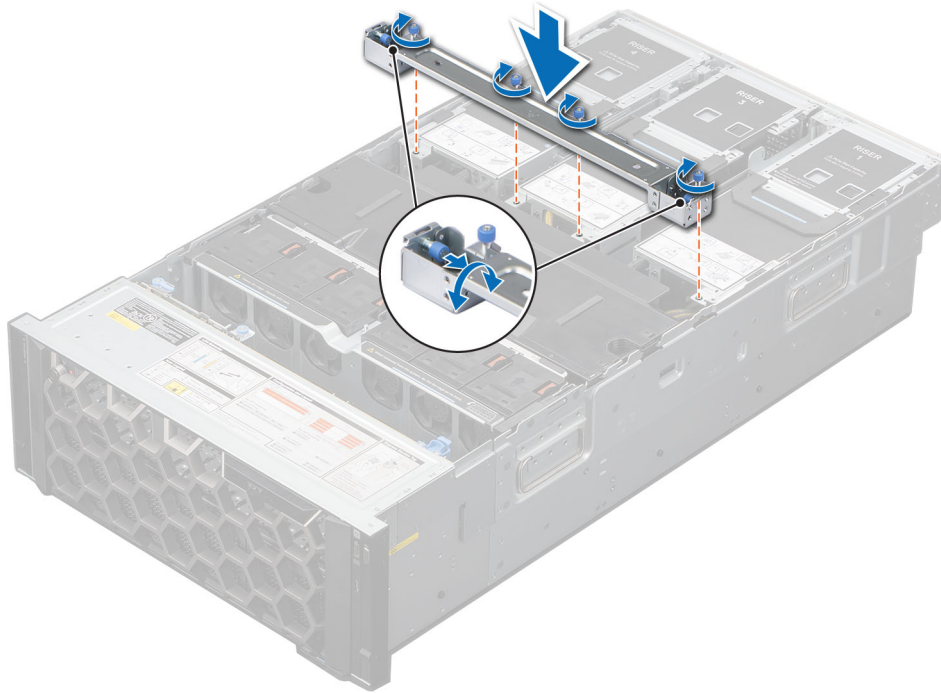

Figure 37. Installing the support bar with full length risers

Next steps

1. Follow the procedure listed in [After working inside your system.](#)

Cooling fans

Removing the cooling fan cage assembly

Prerequisites

1. Follow the safety guidelines listed in the [Safety instructions.](#)
2. Follow the procedure listed in the [Before working inside your system.](#)

Steps

1. Rotate the cooling fan cage handle to unlock the cage assembly from the system.
2. Hold the handle, and lift the cooling fan cage assembly away from the system.

CAUTION: Handle with care because the cooling fan cage assembly is heavy, and lay it down horizontally.

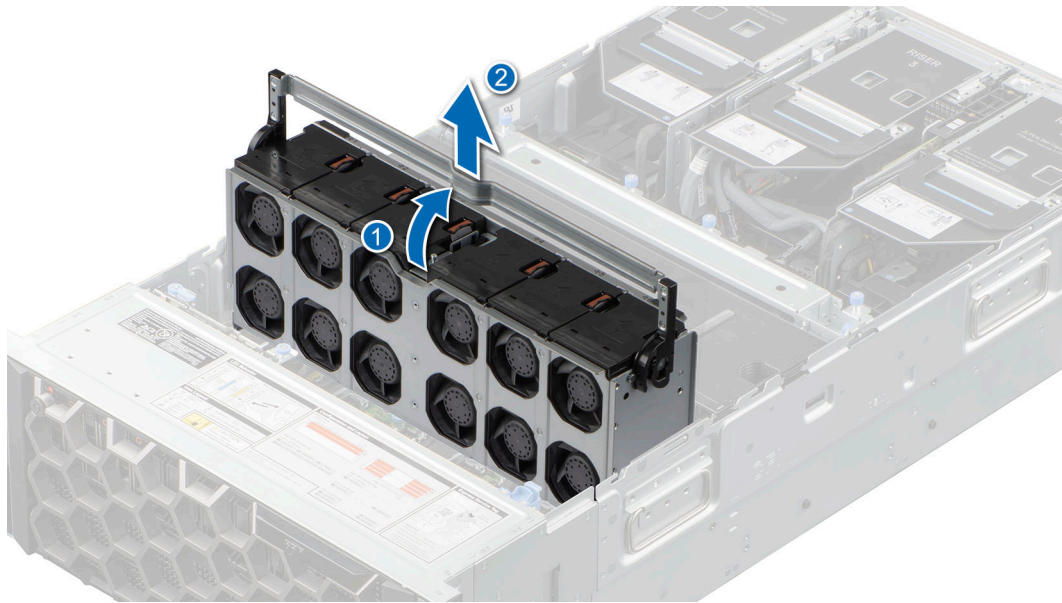

Figure 38. Removing the cooling fan cage assembly

Next steps

1. [Replace the cooling fan cage assembly.](#)

Installing the cooling fan cage assembly

Prerequisites

1. Follow the safety guidelines listed in the [Safety instructions](#).

CAUTION: Ensure that the cables inside the system are correctly installed and retained by the cable retention bracket before installing the cooling fan cage assembly. Incorrectly installed cables may get damaged.

2. Follow the procedure listed in [Before working inside your system](#).

CAUTION: Handle with care because the cooling fan cage assembly is heavy, and lay it down horizontally.

Steps

1. Holding the handle of the cooling fan cage, align the guide rails with the guides on the system.
2. Lower the cooling fan cage assembly into the system until seated firmly.
3. Rotate the handle to lock the cooling fan cage assembly into the system.

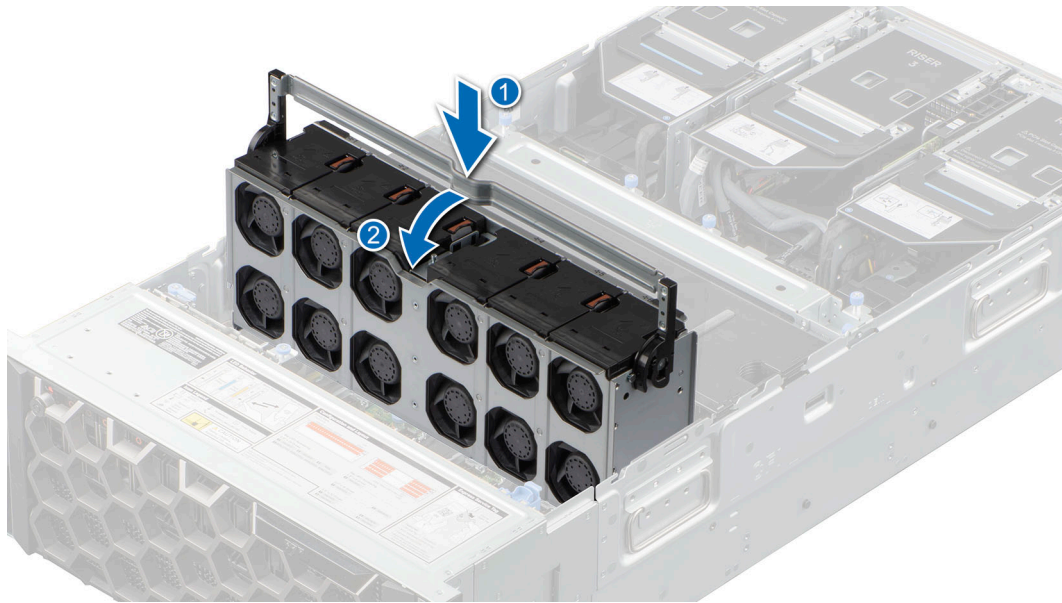

Figure 39. Installing the cooling fan cage assembly

Next steps

1. Follow the procedure listed in [After working inside your system](#).

Removing a cooling fan

Prerequisites

1. Follow the safety guidelines listed in the [Safety instructions](#).
2. Follow the procedure listed in [Before working inside your system](#).

Steps

Press the orange release tab and lift the cooling fan to disconnect the fan from the connector on the system board.

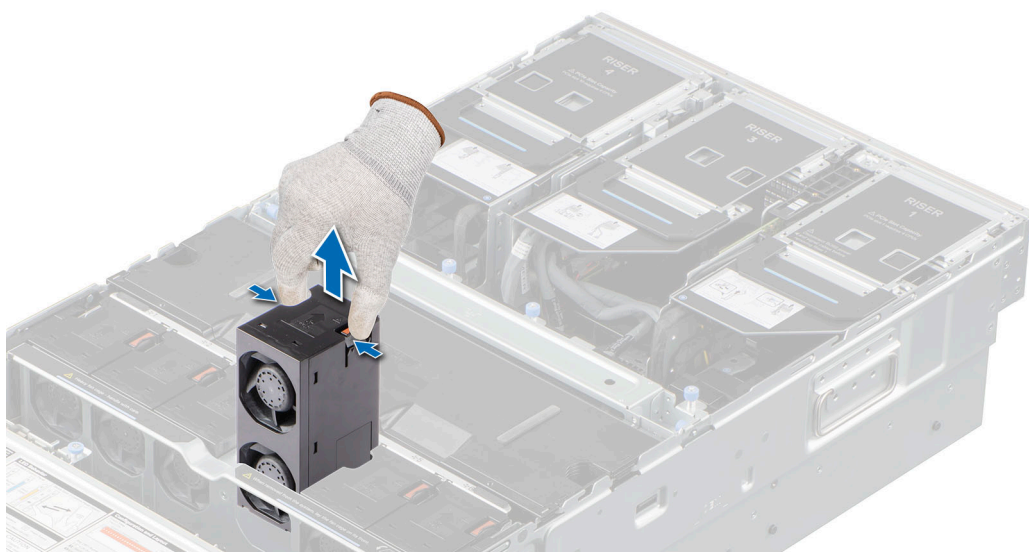

Figure 40. Removing a cooling fan

Next steps

1. [Replace a cooling fan.](#)

Installing a cooling fan

Prerequisites

1. Follow the safety guidelines listed in the [Safety instructions](#).
2. Follow the procedure listed in [Before working inside your system](#).

Steps

Align and lower the cooling fan into the cooling fan assembly until the fan clicks into place.

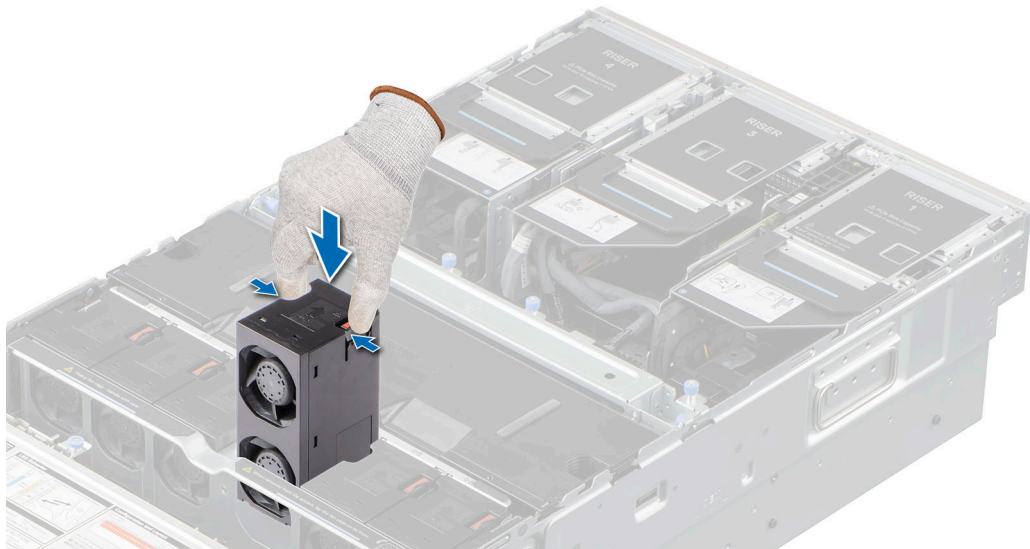

Figure 41. Installing a cooling fan

Next steps

1. Follow the procedure listed in [After working inside your system](#).

Air shrouds

Removing the air shroud top cover

Prerequisites

CAUTION: Never operate your system with the air shroud removed. The system may get overheated quickly, resulting in shutdown of the system and loss of data.

1. Follow the safety guidelines listed in the [Safety instructions](#).
2. Follow the procedure listed in [Before working inside your system](#).
3. [Remove the support bar](#).

Steps

Holding the edges of the air shroud top cover, lift the top cover out of the air shroud.

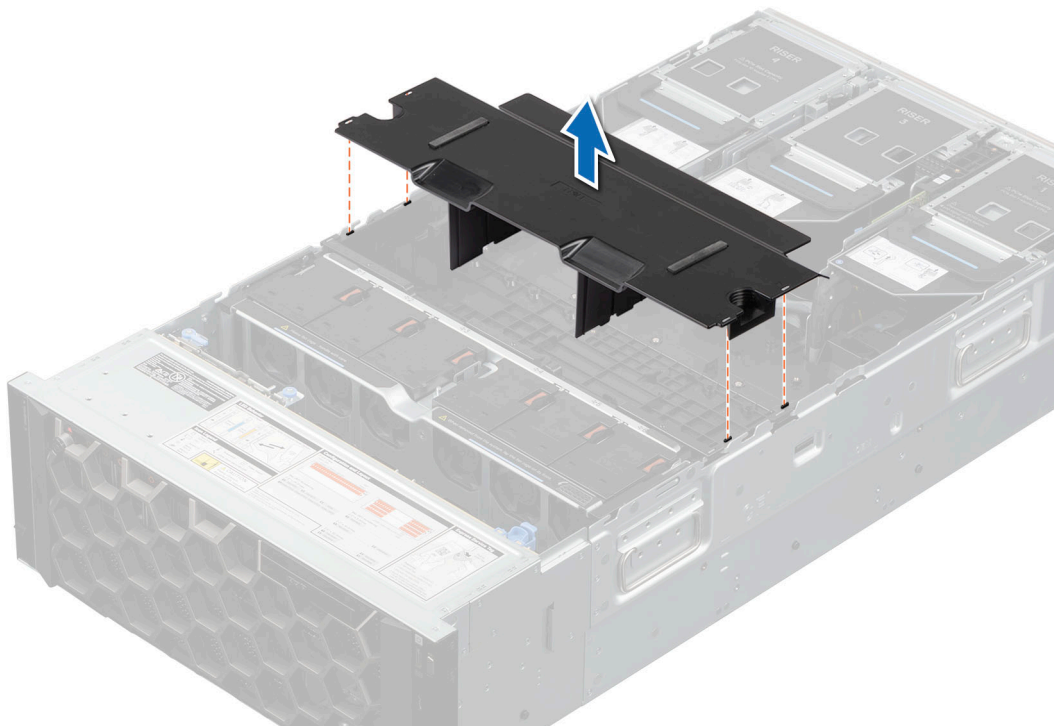

Figure 42. Removing the air shroud top cover

Next steps

1. [Replace the air shroud top cover](#).

Installing the air shroud top cover

Prerequisites

1. Follow the safety guidelines listed in the [Safety instructions](#).
2. Follow the procedure listed in [Before working inside your system](#).
3. [Remove the support bar](#).

Steps

Align the top cover tabs with the slots on the air shroud and lower the top cover until it is firmly seated.

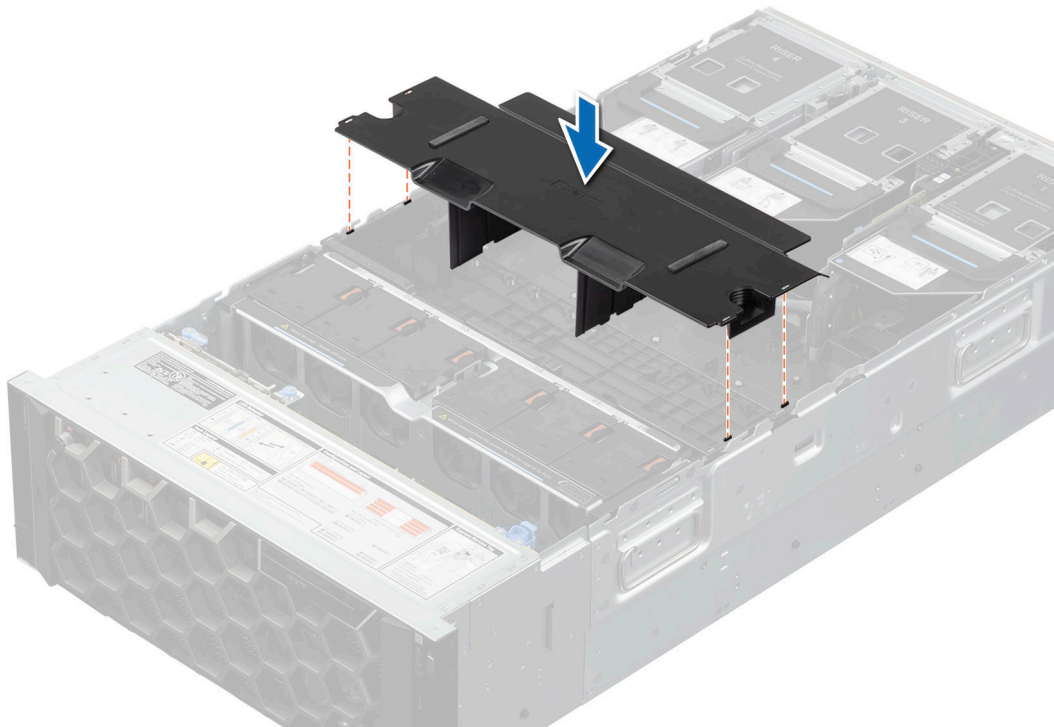

Figure 43. Installing the air shroud top cover

Next steps

1. [Install the support bar.](#)
2. Follow the procedure listed in [After working inside your system.](#)

Removing the air shroud

Prerequisites

CAUTION: Never operate your system with the air shroud removed. The system may get overheated quickly, resulting in shutdown of the system and loss of data.

1. Follow the safety guidelines listed in the [Safety instructions.](#)
2. Follow the procedure listed in [Before working inside your system.](#)
3. [Remove the support bar.](#)
4. [Remove the air shroud top cover.](#)
5. [Remove the cooling fan cage assembly.](#)

Steps

Press the latches on either sides of the air shroud, and lift the air shroud out of the system.

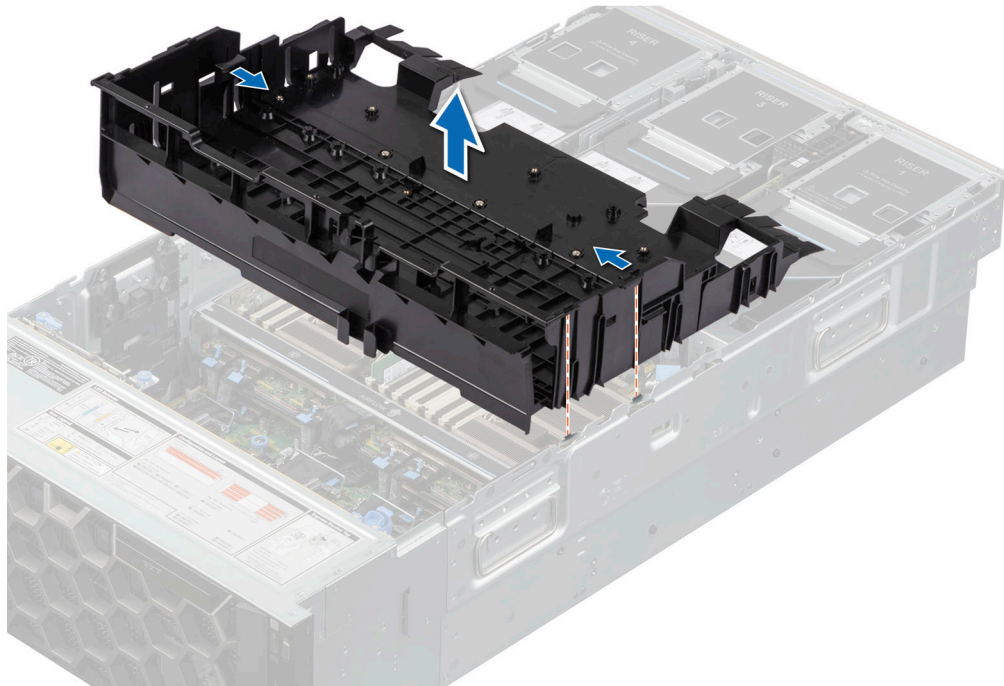

Figure 44. Removing the air shroud

Next steps

1. [Replace the air shroud.](#)

Installing the air shroud

Prerequisites

1. Follow the safety guidelines listed in the [Safety instructions](#).
2. Follow the procedure listed in [Before working inside your system](#).
3. [Remove the support bar.](#)
4. [Remove the air shroud top cover.](#)
5. [Remove the cooling fan cage assembly.](#)

Steps

1. Align the tabs on the air shroud with the slots on the system.
2. Lower the air shroud, until it is firmly seated and secured into the system slots.

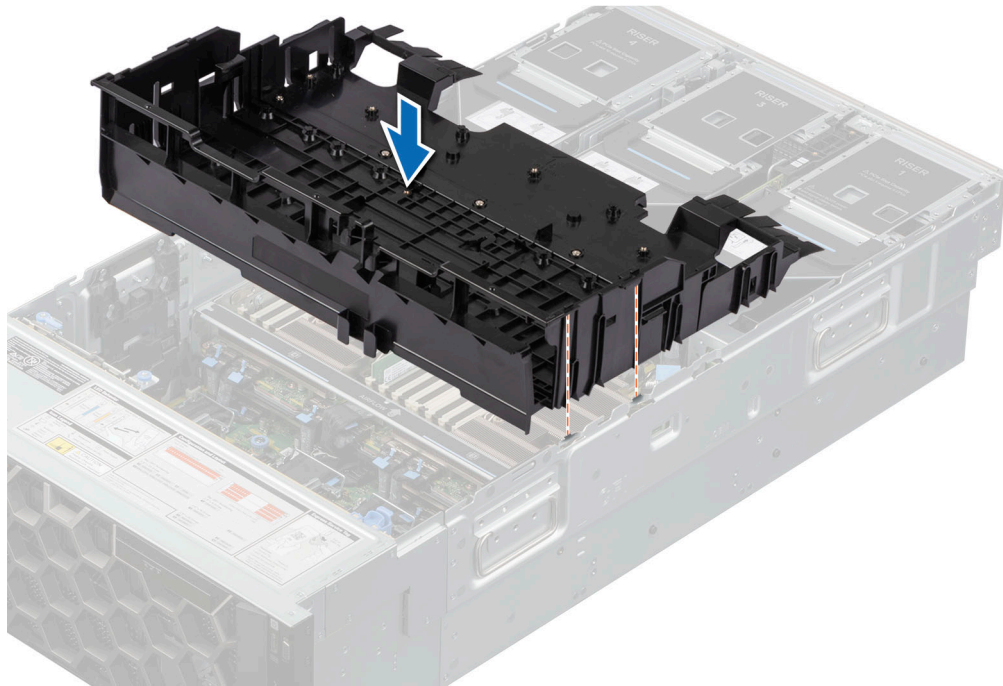

Figure 45. Installing the air shroud

Next steps

1. [Install the cooling fan cage assembly.](#)
2. [Install the air shroud top cover.](#)
3. [Install the support bar.](#)
4. Follow the procedure listed in [After working inside your system.](#)

Removing the GPU air shroud

Prerequisites

CAUTION: Never operate your system with the air shroud removed. The system may get overheated quickly, resulting in shutdown of the system and loss of data.

1. Follow the safety guidelines listed in the [Safety instructions.](#)
2. Follow the procedure listed in [Before working inside your system.](#)
3. [Remove the support bar.](#)
4. [Remove the air shroud top cover.](#)
5. [Remove the cooling fan cage assembly.](#)
6. [Remove the full length expansion card risers.](#)

CAUTION: The full length expansion card risers must be removed before removing the GPU air shroud.

Steps

Press the latches on either sides of the GPU air shroud, and lift the GPU air shroud out of the system.

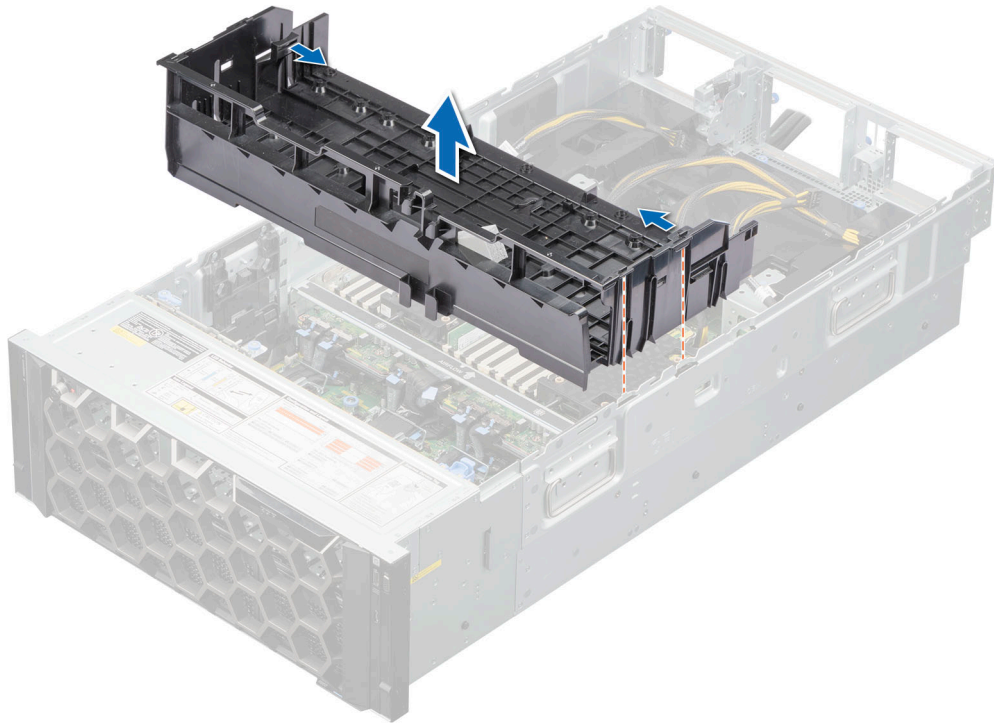

Figure 46. Removing the GPU air shroud

Next steps

1. [Replace the GPU air shroud.](#)

Installing the GPU air shroud

Prerequisites

1. Follow the safety guidelines listed in the [Safety instructions](#).
2. Follow the procedure listed in [Before working inside your system](#).
3. [Remove the support bar.](#)
4. [Remove the air shroud top cover.](#)
5. [Remove the cooling fan cage assembly.](#)
6. [Remove the full length expansion card risers.](#)

Steps

1. Align the tabs on the GPU air shroud with the slots on the system.
2. Lower the GPU air shroud, until it is firmly seated and secured into the system slots.

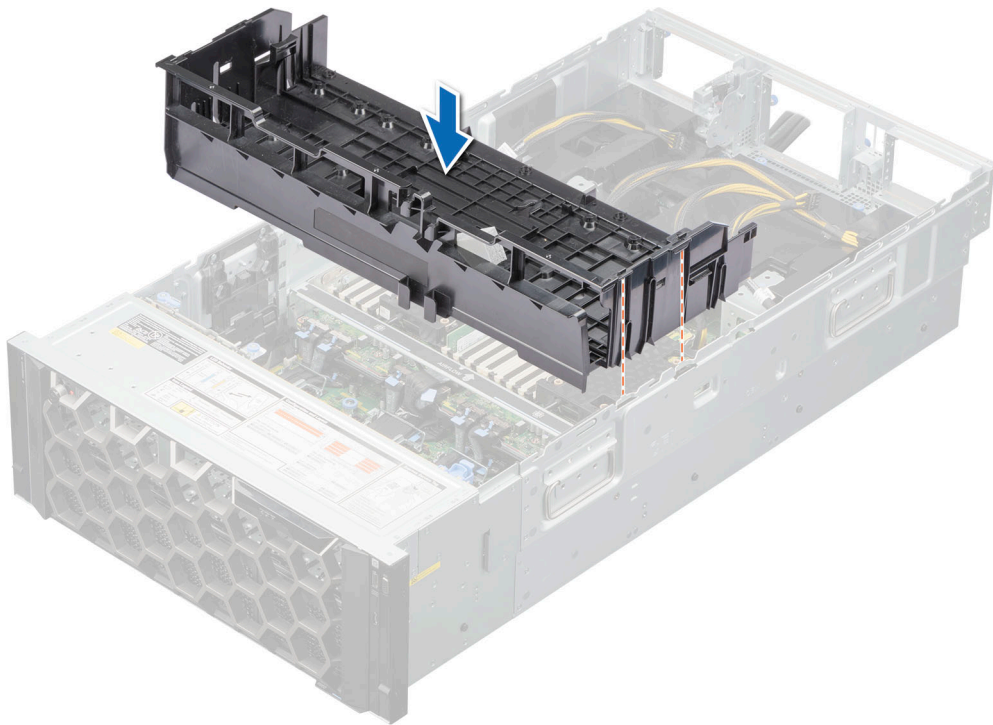

Figure 47. Installing the GPU air shroud

Next steps

1. Install the full length expansion risers.
2. Install the cooling fan cage assembly.
3. Install the air shroud top cover.
4. Install the support bar.
5. Follow the procedure listed in [After working inside your system](#).

Removing the riser air shroud

Prerequisites

⚠ CAUTION: Never operate your system with the air shroud removed. The system may get overheated quickly, resulting in shutdown of the system and loss of data.

1. Follow the safety guidelines listed in the [Safety instructions](#).
2. Follow the procedure listed in [Before working inside your system](#).
3. Remove the support bar.
4. Remove the air shroud top cover
5. Remove the cooling fan cage assembly.
6. If required, remove the air shroud.
7. Remove the expansion card risers or remove the full length expansion card riser.

i NOTE: See [cable routing](#) section for more information.

Steps

1. Holding the latches, slide the riser air shroud to the front of the system.
2. Lift the riser air shroud out of the system.

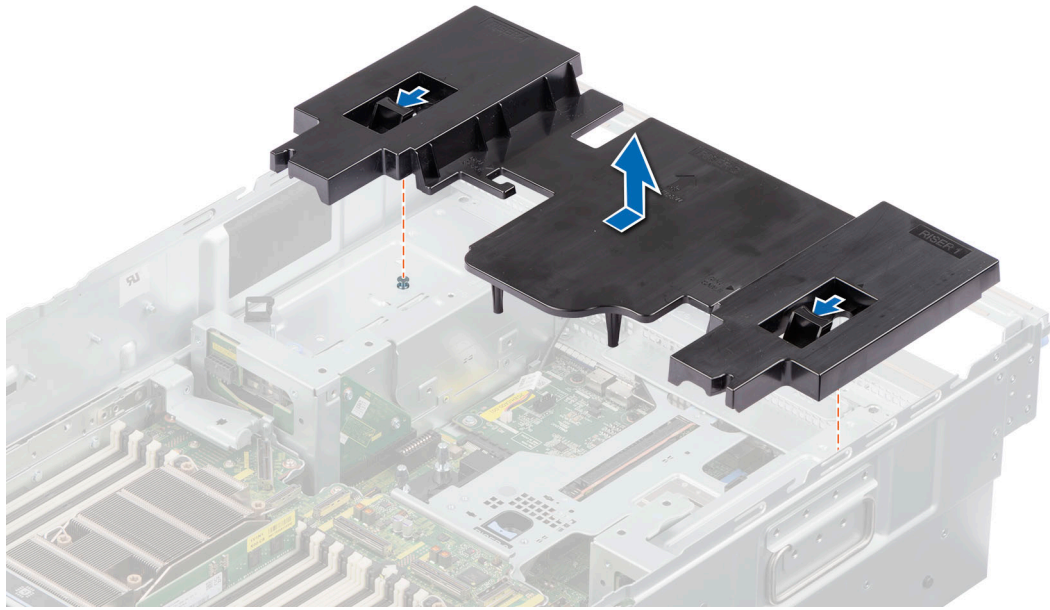

Figure 48. Removing the riser air shroud

Next steps

1. [Replace the riser air shroud.](#)

Installing the riser air shroud

Prerequisites

1. Follow the safety guidelines listed in the [Safety instructions](#).
2. Follow the procedure listed in [Before working inside your system](#).
3. [Remove the support bar.](#)
4. [Remove the air shroud top cover](#)
5. [Remove the cooling fan cage assembly.](#)
6. If required, [remove the air shroud.](#)
7. [Remove the expansion card risers](#) or [remove the full length expansion card riser.](#)

i **NOTE:** See [cable routing](#) section for more information.

Steps

1. Align the slots on the riser air shroud with the guides on the system.
2. Lower the riser air shroud and, using the latches, slide it to the rear of the system until it is firmly seated.

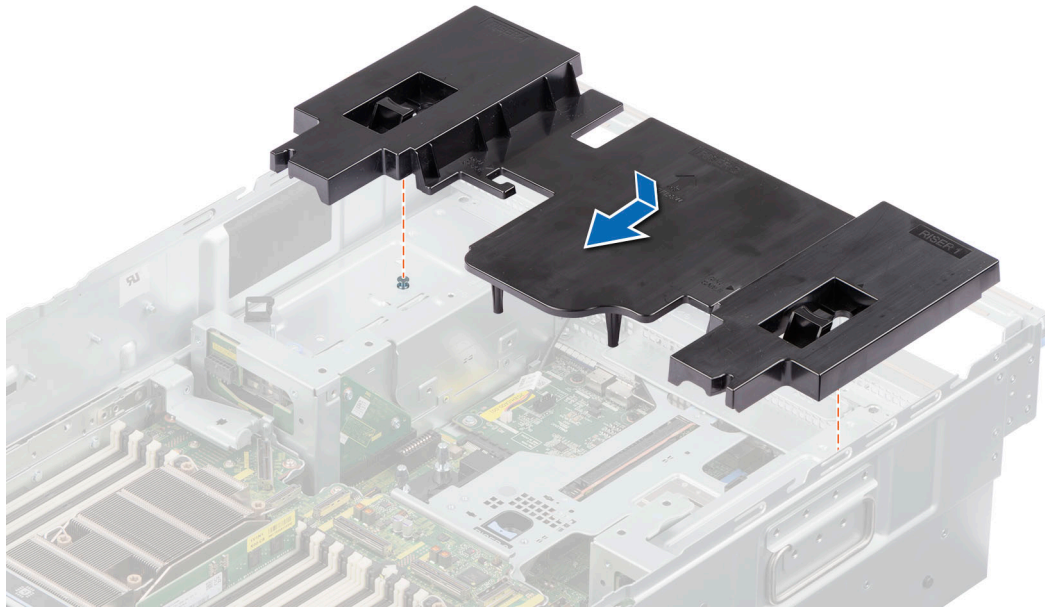

Figure 49. Installing the riser air shroud

Next steps

1. Install the expansion card risers or install the full length expansion card riser.
2. If removed, install the air shroud
3. Install the cooling fan cage assembly.
4. Install the air shroud top cover.
5. Install the support bar.
6. Follow the procedure listed in [After working inside your system](#).

Drives

Removing a drive blank

Prerequisites

1. Follow the safety guidelines listed in the [Safety instructions](#).
2. If installed, [remove the front bezel](#).

CAUTION: To maintain proper system cooling, drive blanks must be installed in all empty drive slots.

Steps

Press the release button, and slide the drive blank out of the drive slot.

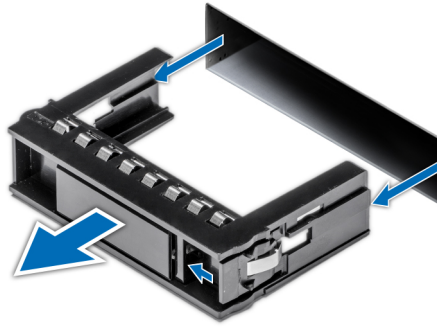

Figure 50. Removing a drive blank

Next steps

1. Replace the drive blank.

Installing a drive blank

Prerequisites

1. Follow the safety guidelines listed in the [Safety instructions](#).
2. If installed, [remove the front bezel](#).

Steps

Slide the drive blank into the drive slot until the release button clicks into place.

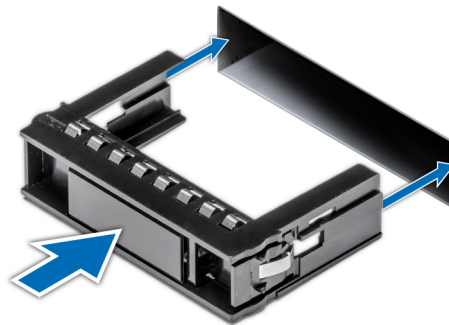

Figure 51. Installing a drive blank

Next steps

1. If removed, [install the front bezel](#).

Removing a drive carrier

Prerequisites

1. Follow the safety guidelines listed in [Safety instructions](#).
2. [Remove the front bezel](#).
3. Using the management software, prepare the drive for removal. If the drive is online, the green activity or fault indicator flashes while the drive is turning off. When the drive indicators are off, the drive is ready for removal. For more information, see the storage controller documentation.

CAUTION: Before attempting to remove or install a drive while the system is running, see the documentation for the storage controller card to ensure that the host adapter is configured correctly to support drive removal and insertion.

CAUTION: To prevent data loss, ensure that your operating system supports drive installation. See the documentation supplied with your operating system.

Steps

1. Press the release button to open the drive carrier release handle.
2. Holding the drive carrier release handle, slide the drive carrier out of the drive slot.

NOTE: If you are not replacing the drive immediately, install a drive blank in the empty drive slot to maintain proper system cooling.



Figure 52. Removing a drive carrier

Next steps

Replace the drive or a drive blank.

Installing the drive carrier

Prerequisites

CAUTION: Before removing or installing a drive while the system is running, see the www.dell.com/storagecontrollermanuals documentation for the storage controller card to ensure that the host adapter is configured correctly to support drive removal and insertion.

CAUTION: Combining SAS and SATA drives in the same RAID volume is not supported.

CAUTION: When installing a drive, ensure that the adjacent drives are fully installed. Inserting a drive carrier and attempting to lock its handle next to a partially installed carrier can damage the partially installed carrier's shield spring and make it unusable.

NOTE: Ensure that the drive carrier's release handle is in the open position before inserting the carrier into the slot.

CAUTION: To prevent data loss, ensure that your operating system supports hot-swap drive installation. See the documentation supplied with your operating system.

CAUTION: When a replacement hot swappable drive is installed and the system is powered on, the drive automatically begins to rebuild. Ensure that the replacement drive is blank or contains data that you wish to overwrite. Any data on the replacement drive is immediately lost after the drive is installed.

1. Follow the safety guidelines listed in [Safety instructions](#).
2. [Remove the front bezel](#).
3. Remove the drive carrier or remove the drive blank when you want to assemble the drive into the system.

Steps

1. Slide the drive carrier into the drive slot and push until the drive connects with the backplane.
2. Close the drive carrier release handle to lock the drive in place.



Figure 53. Installing a drive carrier

Next steps

[Install the front bezel](#).

Removing the drive from the drive carrier

Prerequisites

1. Follow the safety guidelines listed in the [Safety instructions](#).
2. [Remove the drive carrier](#).

Steps

1. Using a Phillips #1 screwdriver, remove the screws from the slide rails on the drive carrier.



NOTE: If the drive carrier has Torx screw , use Torx 6 (for 2.5-inch drive) or Torx 8 (for 3.5-inch drive) screwdriver to remove the drive.

2. Lift the drive out of the drive carrier.



Figure 54. Removing the drive from the drive carrier

Next steps

Install the drive into the drive carrier.

Installing the drive into the drive carrier

Prerequisites

1. Follow the safety guidelines listed in the [Safety instructions](#).
2. [Remove the drive blank](#) or [remove the drive carrier](#).

Steps

1. Insert the drive into the drive carrier with the drive connector facing towards the rear of the carrier.
2. Align the screw holes on the drive with the screws holes on the drive carrier.
3. Using a Phillips #1 screwdriver, secure the drive to the drive carrier with the screws.

i **NOTE:** When installing a drive into the drive carrier, ensure that the screws are torqued to 4 in-lbf.

i **NOTE:** If the drive carrier has Torx screw , use Torx 6 (for 2.5-inch drive) or Torx 8 (for 3.5-inch drive) screwdriver to install the drive.



Figure 55. Installing a drive into the drive carrier

Next steps

1. [Install the drive carrier.](#)

Removing an EDSFF E3.S drive blank

Prerequisites

1. Follow the safety guidelines listed in the [Safety instructions](#).
2. If installed, [remove the front bezel](#).

CAUTION: To maintain proper system cooling, drive blanks must be installed in all empty drive slots.

Steps

Lift the release button, and slide the drive blank out of the drive slot.



Figure 56. Removing an EDSFF E3.S drive blank

Next steps

1. [Replace the EDSFF E3.S drive blank.](#)

Installing an EDSFF E3.S drive blank

Prerequisites

1. Follow the safety guidelines listed in the [Safety instructions](#).
2. If installed, [remove the front bezel](#).

Steps

Slide the drive blank into the drive slot until the release button clicks into place.



Figure 57. Installing an EDSFF E3.S drive blank

Next steps

1. If removed, [install the front bezel](#).

Removing an EDSFF E3.S drive carrier

Prerequisites

1. Follow the safety guidelines listed in [Safety instructions](#).
2. [Remove the front bezel](#).
3. Using the management software, prepare the drive for removal. If the drive is online, the green activity or fault indicator flashes while the drive is turning off. When the drive indicators are off, the drive is ready for removal. For more information, see the storage controller documentation.

CAUTION: Before attempting to remove or install a drive while the system is running, see the documentation for the storage controller card to ensure that the host adapter is configured correctly to support drive removal and insertion.

CAUTION: To prevent data loss, ensure that your operating system supports drive installation. See the documentation supplied with your operating system.

Steps

1. Lift the release button to open the drive carrier release handle.
2. Holding the drive carrier release handle, slide the drive carrier out of the drive slot.

NOTE: If you are not replacing the drive immediately, install an EDSFF E3.S drive blank in the empty drive slot to maintain proper system cooling.

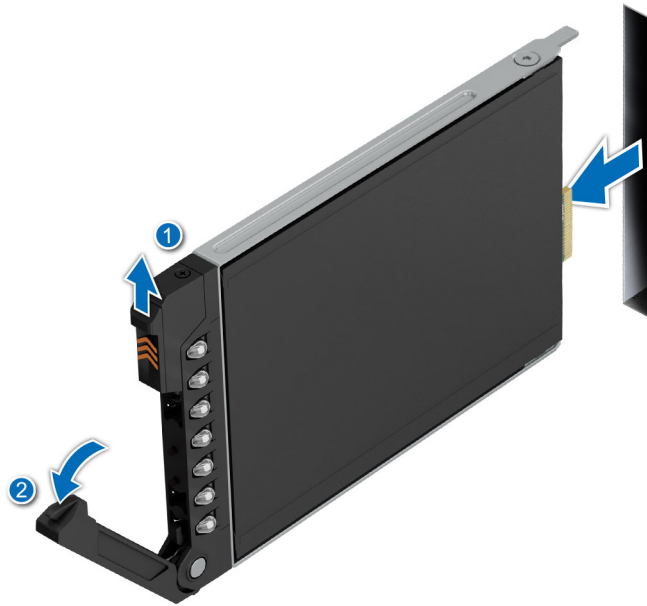

Figure 58. Removing an EDSFF E3.S drive carrier

Next steps

Replace the EDSFF E3.S drive or an EDSFF E3.S drive blank.

Installing an EDSFF E3.S drive carrier

Prerequisites

- ⚠ **CAUTION:** Before removing or installing a drive while the system is running, see the www.dell.com/storagecontrollermanuals documentation for the storage controller card to ensure that the host adapter is configured correctly to support drive removal and insertion.
- ⚠ **CAUTION:** Combining SAS and SATA drives in the same RAID volume is not supported.
- ⚠ **CAUTION:** When installing a drive, ensure that the adjacent drives are fully installed. Inserting a drive carrier and attempting to lock its handle next to a partially installed carrier can damage the partially installed carrier's shield spring and make it unusable.
- ℹ **NOTE:** Ensure that the drive carrier's release handle is in the open position before inserting the carrier into the slot.
- ⚠ **CAUTION:** To prevent data loss, ensure that your operating system supports hot-swap drive installation. See the documentation supplied with your operating system.
- ⚠ **CAUTION:** When a replacement hot swappable drive is installed and the system is powered on, the drive automatically begins to rebuild. Ensure that the replacement drive is blank or contains data that you wish to overwrite. Any data on the replacement drive is immediately lost after the drive is installed.

1. Follow the safety guidelines listed in [Safety instructions](#).
2. [Remove the front bezel](#).
3. Remove the drive carrier or remove the drive blank when you want to assemble the drive into the system.

Steps

1. Slide the drive carrier into the drive slot and push until the drive connects with the backplane.
2. Close the drive carrier release handle to lock the drive in place.

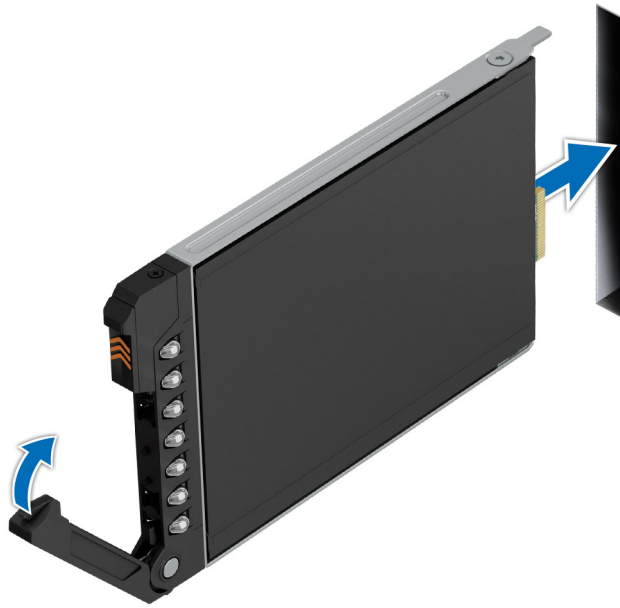

Figure 59. Installing an EDSFF E3.S drive carrier

Next steps

Install the front bezel.

Removing an EDSFF E3.S drive from the drive carrier

Prerequisites

1. Follow the safety guidelines listed in the [Safety instructions](#).
2. [Remove an EDSFF E3.S drive carrier](#).

Steps

1. Using a Torx 6 screwdriver, remove the screws from the slide rails on the drive carrier.



2. Lift the drive out of the drive carrier.

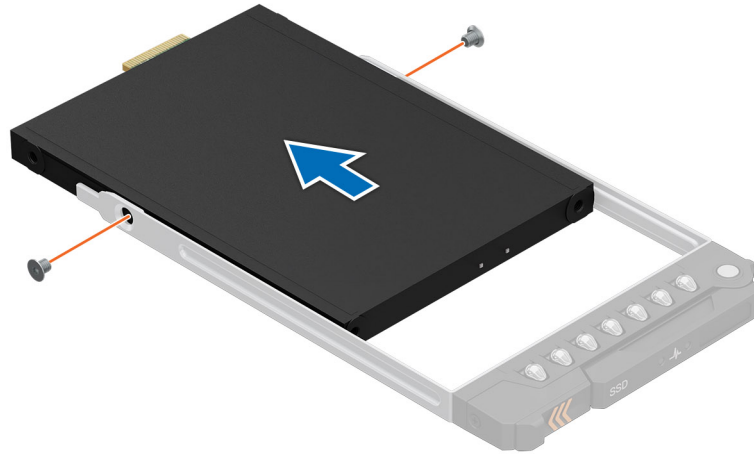

Figure 60. Removing an EDSFF E3.S drive from the drive carrier

Next steps

Install an EDSFF E3.S drive into the drive carrier.

Installing an EDSFF E3.S drive into the drive carrier

Prerequisites

1. Follow the safety guidelines listed in the [Safety instructions](#).
2. [Remove an EDSFF E3.S drive blank](#) or [Remove an EDSFF E3.S drive carrier](#).

Steps

1. Insert the drive into the drive carrier with the drive connector facing towards the rear of the carrier.
2. Align the screw holes on the drive with the screws holes on the drive carrier.
3. Using a Torx 6 screwdriver, secure the drive to the drive carrier with the screws.

NOTE: When installing a drive into the drive carrier, ensure that the screws are torqued to 4 in-lbs.



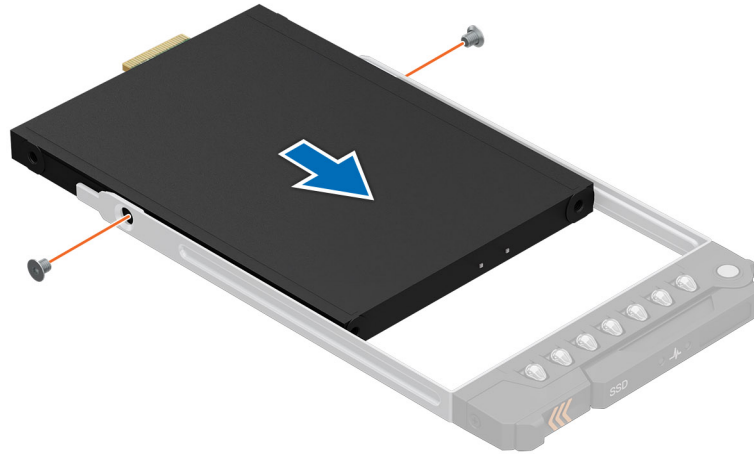

Figure 61. Installing an EDSFF E3.S drive into the drive carrier

Next steps

1. [Install the drive carrier.](#)

Drive backplane

This is a service technician replaceable part only.

Drive backplane

Depending on your system configuration, the drive backplanes that are supported are listed here:

Table 65. Supported backplane options

System	Supported drive backplanes
PowerEdge R960	2.5-inch (x 8) NVMe backplane
	2.5-inch (x 8) SAS, or SATA backplane
	2.5-inch (x 24) NVMe backplane
	EDSFF E3.S (x8) NVMe backplane

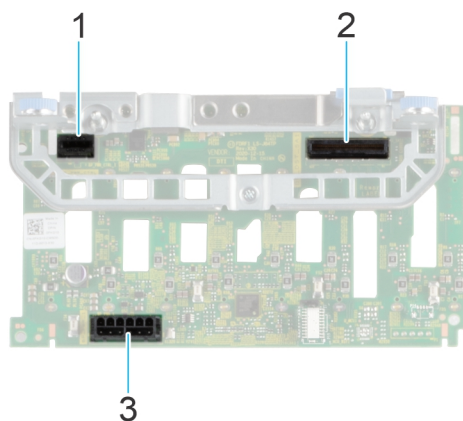

Figure 62. 8 x 2.5-inch NVMe drive backplane

1. BP_PWR_CTRL
2. BP_DST_SA1 (PERC to backplane)
3. BP_PWR_1 (backplane power and signal cable to system board)

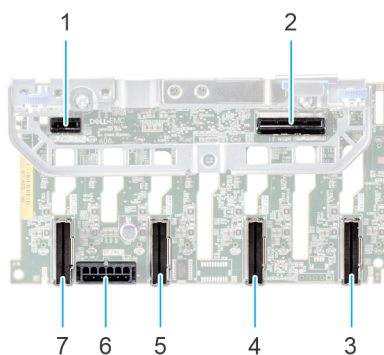

Figure 63. 8 x 2.5-inch SAS or SATA drive backplane

1. BP_PWR_CTRL
2. BP_DST_SA1 (PERC to backplane)
3. BP_DST_PA1 (PCIe/NVMe connector)
4. BP_DST_PB1 (PCIe/NVMe connector)
5. BP_DST_PA2 (PCIe/NVMe connector)
6. BP_PWR_1 (backplane power and signal cable to system board)
7. BP_DST_PB2 (PCIe/NVMe connector)

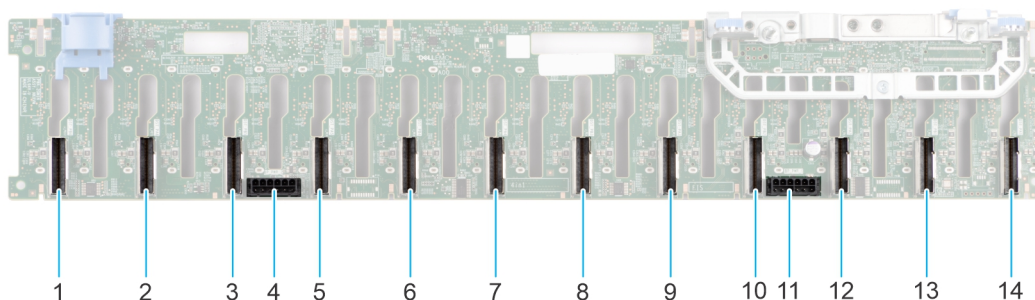

Figure 64. 24 x 2.5-inch NVMe passive backplane

1. BP_DST_PB6 (PCIe/NVMe connector)
2. BP_DST_PA6 (PCIe/NVMe connector)
3. BP_DST_PB5 (PCIe/NVMe connector)
4. BP_PWR_2
5. BP_DST_PA5 (PCIe/NVMe connector)
6. BP_DST_PB4 (PCIe/NVMe connector)
7. BP_DST_PA4 (PCIe/NVMe connector)
8. BP_DST_PB3 (PCIe/NVMe connector)
9. BP_DST_PA3 (PCIe/NVMe connector)
10. BP_DST_PB2 (PCIe/NVMe connector)

- 11. BP_PWR_1
- 12. BP_DST_PA2 (PCIe/NVMe connector)
- 13. BP_DST_PB1 (PCIe/NVMe connector)
- 14. BP_DST_PA1 (PCIe/NVMe connector)

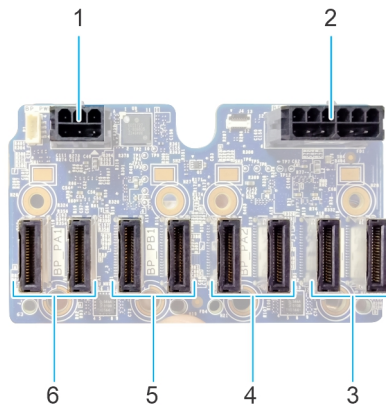

Figure 65. EDSFF E3.S NVMe drive backplane

- 1. BP_PWR_CTRL
- 2. BP_PWR_1 (backplane power cable to system board)
- 3. BP_PB2 (PCIe/NVMe connector)
- 4. BP_PA2 (PCIe/NVMe connector)
- 5. BP_PB1 (PCIe/NVMe connector)
- 6. BP_PA1 (PCIe/NVMe connector)

Removing the drive backplane

Prerequisites

CAUTION: To prevent damage to the drives and backplane, remove the drives from the system before removing the backplane.

CAUTION: Note the number of each drive and temporarily label them before you remove the drive so that you can reinstall them in the same location.

NOTE: The procedure to remove the backplane is similar for all the backplane configurations.

1. Follow the safety guidelines listed in the [Safety instructions](#).
 2. Follow the procedure listed in the [Before working inside your system](#).
 3. If required, [remove the support bar](#).
 4. If required, [remove the air shroud top cover](#).
 5. [Remove the cooling fan cage assembly](#).
 6. If required, [remove the air shroud](#) or [remove the GPU air shroud](#).
- NOTE:** The GPU air shroud can be removed only after the full length expansion card risers have been removed.
7. [Remove the drives](#).
 8. If installed, [remove the rear mounting front PERC module](#).
 9. If required, [remove the PEM](#).
 10. Observe and disconnect the drive backplane cables from the connector on the system board and backplane.

NOTE: See [cable routing](#) section for more information.

Steps

1. Press the release tab to disengage the drive backplane from the hooks on the system.
 2. Lift and pull the drive backplane out of the system.
- NOTE:** To avoid damaging the backplane, remove the disconnected backplane cables from the cable routing clips before removing the backplane.

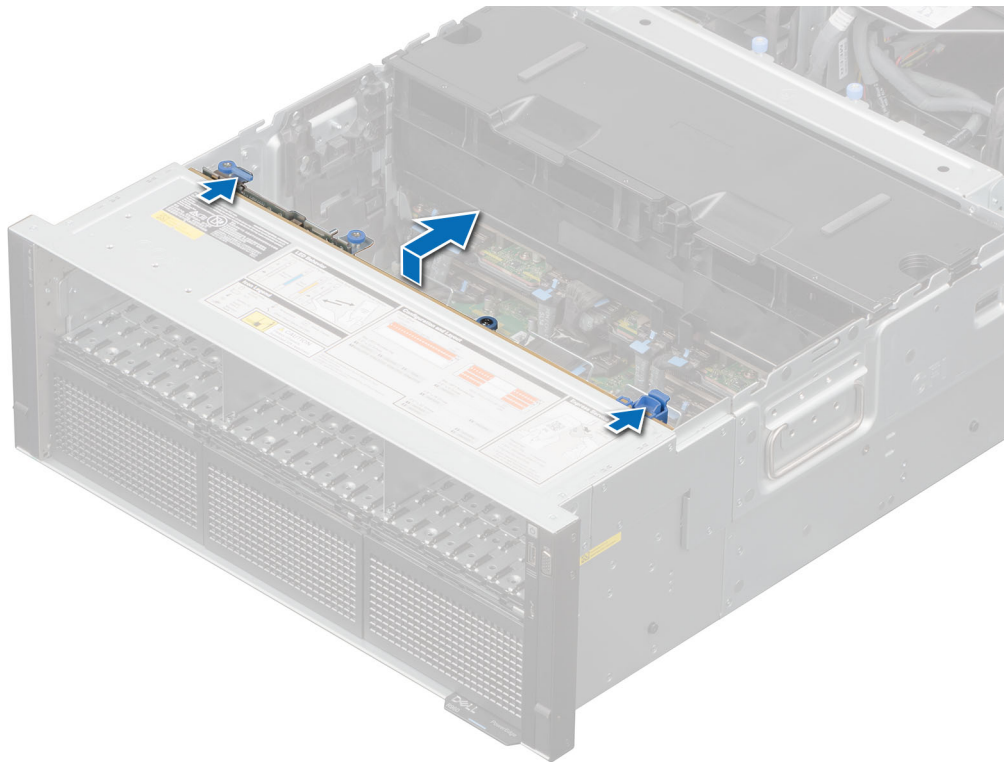

Figure 66. Removing the drive backplane

Next steps

1. [Replace the drive backplane.](#)

Installing the drive backplane

Prerequisites

1. Follow the safety guidelines listed in the [Safety instructions](#).
2. Follow the procedure listed in the [Before working inside your system](#).
3. If required, [remove the support bar](#).
4. If required, [remove the air shroud top cover](#).
5. [Remove the cooling fan cage assembly](#).
6. If required, [remove the air shroud](#) or [remove the GPU air shroud](#).
 - i** **NOTE:** The GPU air shroud can be removed only after the full length expansion card risers have been removed.
7. [Remove the drives](#).
8. If installed, [remove the rear mounting front PERC module](#).
9. If required, [remove the PEM](#).
10. Observe and disconnect the drive backplane cables from the connector on the system board and backplane.
 - i** **NOTE:** See [cable routing](#) section for more information.
 - i** **NOTE:** To avoid damaging the backplane, remove the disconnected backplane cables from the cable routing clips.
 - i** **NOTE:** Route the cable properly when you replace it to prevent the cable from being pinched or crimped.

Steps

1. Align the slots on the drive backplane with the guides on the system.
2. Slide the drive backplane into the guides and lower the backplane until the blue release tab clicks into place.

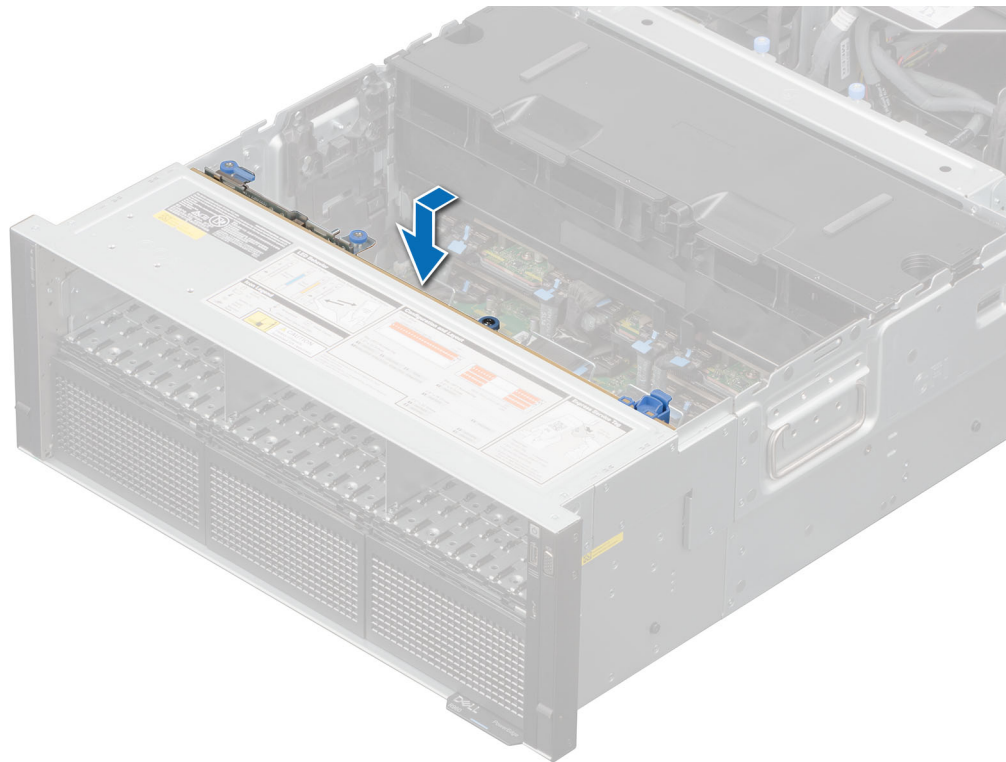

Figure 67. Installing the drive backplane

Next steps

1. Connect the drive backplane cables to the connectors on the system board and backplane.
2. If removed, [install the PEM](#).
3. [Install the drives](#).
4. If removed, [install the rear mounting front PERC module](#).
5. If removed, [install the air shroud](#) or [install the GPU air shroud](#).
6. [Install the cooling fan cage assembly](#).
7. If removed, [install the air shroud top cover](#).
8. If removed, [install the support bar](#).
9. Follow the procedure listed in [After working inside your system](#).

Side wall brackets

Removing the side wall bracket

There are two side wall brackets on either side of the system. The procedure to remove is similar.

Prerequisites

1. Follow the safety guidelines listed in the [Safety instructions](#).
2. Follow the procedure listed in the [Before working inside your system](#).
3. [Remove the support bar](#).
4. [Remove the air shroud top cover](#).
5. [Remove the cooling fan cage assembly](#).
6. If required, [remove the air shroud](#) or [remove the GPU air shroud](#).

i **NOTE:** Ensure that you note the routing of the cables as you remove them from the system board. Route the cables properly when you replace them to prevent the cables from being pinched or crimped.

Steps

1. Press the tabs to release the side wall cable holder.

i **NOTE:** Move the cables out of the side wall cable holder and observe the cable routing.

2. Press the center tab to release the bracket from the chassis, and lift it away from the system.

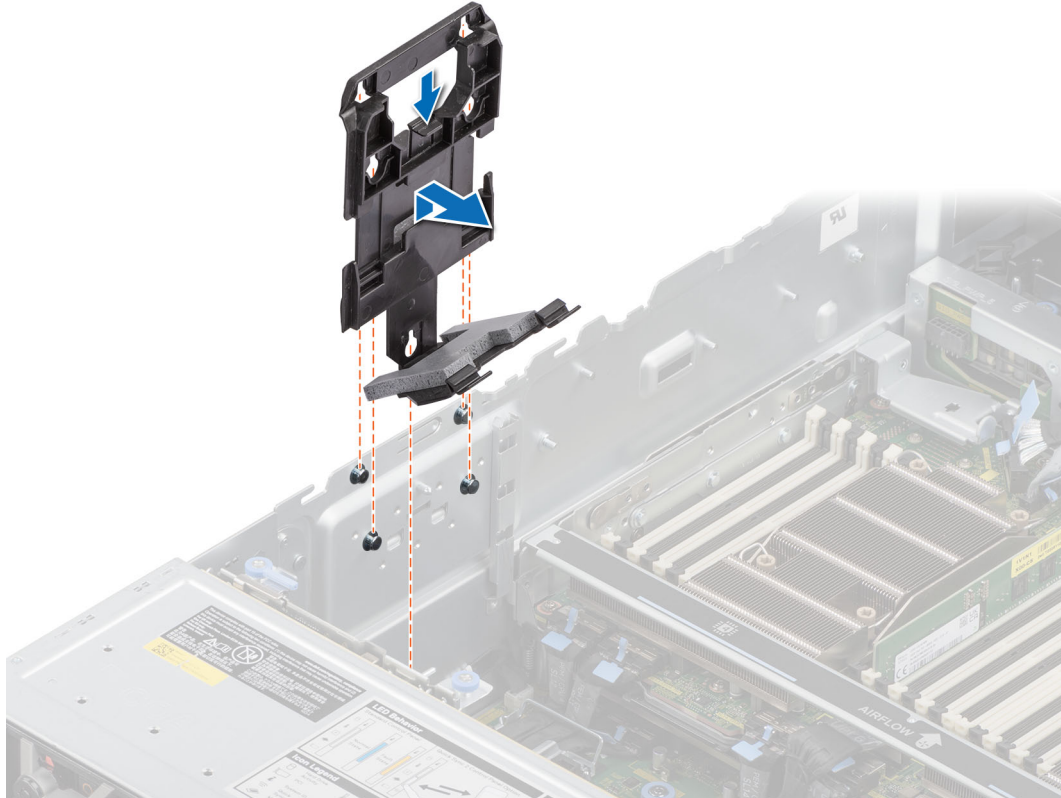

Figure 68. Removing the side wall bracket

Next steps

1. [Replace the side wall bracket.](#)

Installing the side wall bracket

There are two side wall brackets on either side of the system. The procedure to install is similar.

Prerequisites

1. Follow the safety guidelines listed in the [Safety instructions](#).
2. Follow the procedure listed in the [Before working inside your system](#).
3. [Remove the support bar.](#)
4. [Remove the air shroud top cover.](#)
5. [Remove the cooling fan cage assembly.](#)
6. If required, [remove the air shroud](#) or [remove the GPU air shroud](#).

Steps

1. Align the guide slots on the side wall bracket with the guides on the system and slide until the cover is seated firmly.

i **NOTE:** Route the cables through the side wall cable holder properly to prevent the cables being pinched or crimped.

2. Close the side wall cable holder until the holder clicks into place.

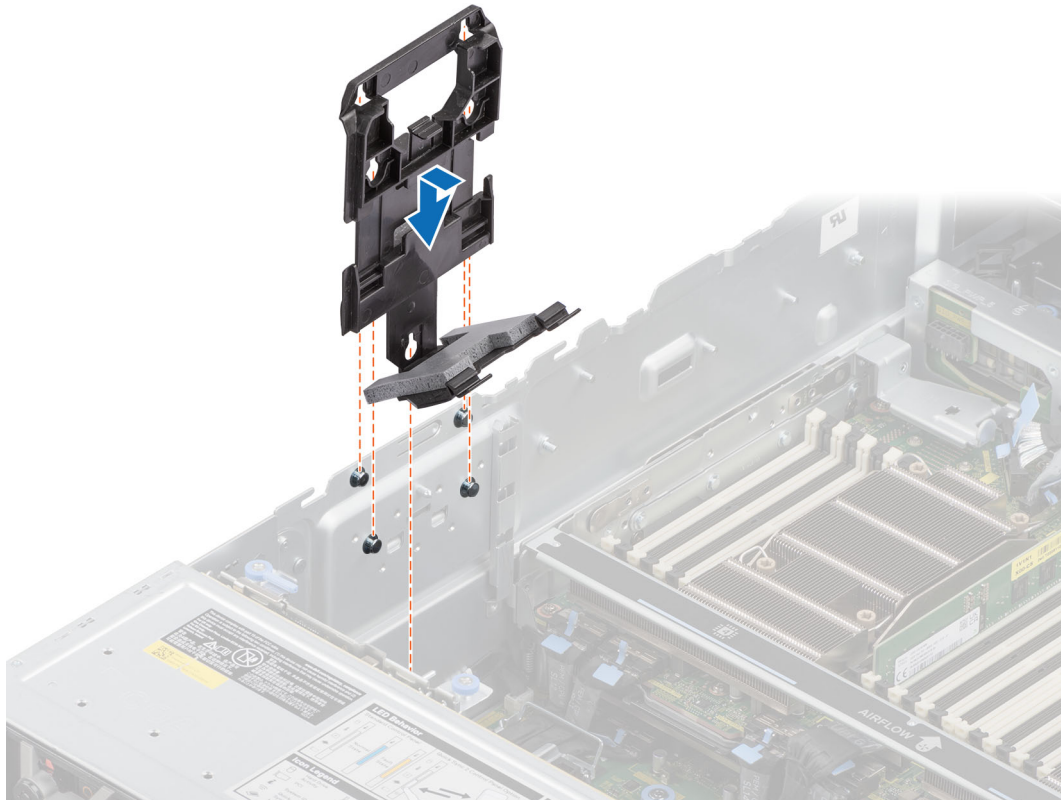

Figure 69. Installing the side wall bracket

Next steps

1. If removed, install the air shroud or install the GPU air shroud.
2. Install the cooling fan cage assembly.
3. Install the air shroud top cover.
4. Install the support bar.
5. Follow the procedure listed in the [After working inside your system](#).

Cable routings

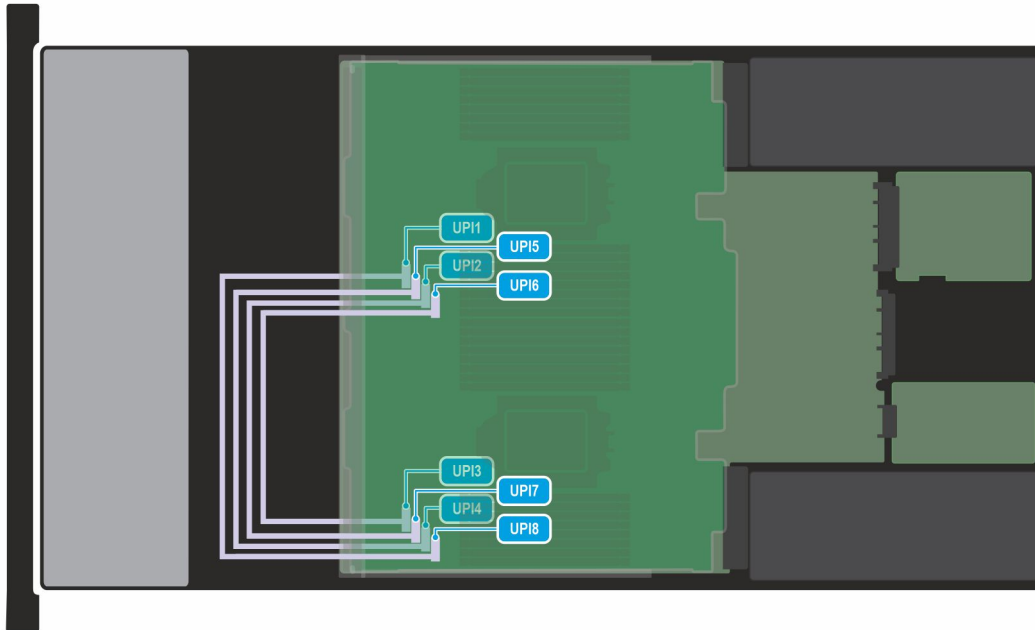

Figure 70. Configuration 0: UPI cables

NOTE: Follow the sequential order as shown in the table to remove the cables, to install the cables follow the reverse sequential order.

Table 66. UPI cables

Order	From	To
1	UPI1 (UPI signal connector on system board)	UPI8 (UPI signal connector on PEM)
2	UPI2 (UPI signal connector on system board)	UPI7 (UPI signal connector on PEM)
3	UPI3 (UPI signal connector on system board)	UPI6 (UPI signal connector on PEM)
4	UPI4 (UPI signal connector on system board)	UPI5 (UPI signal connector on PEM)

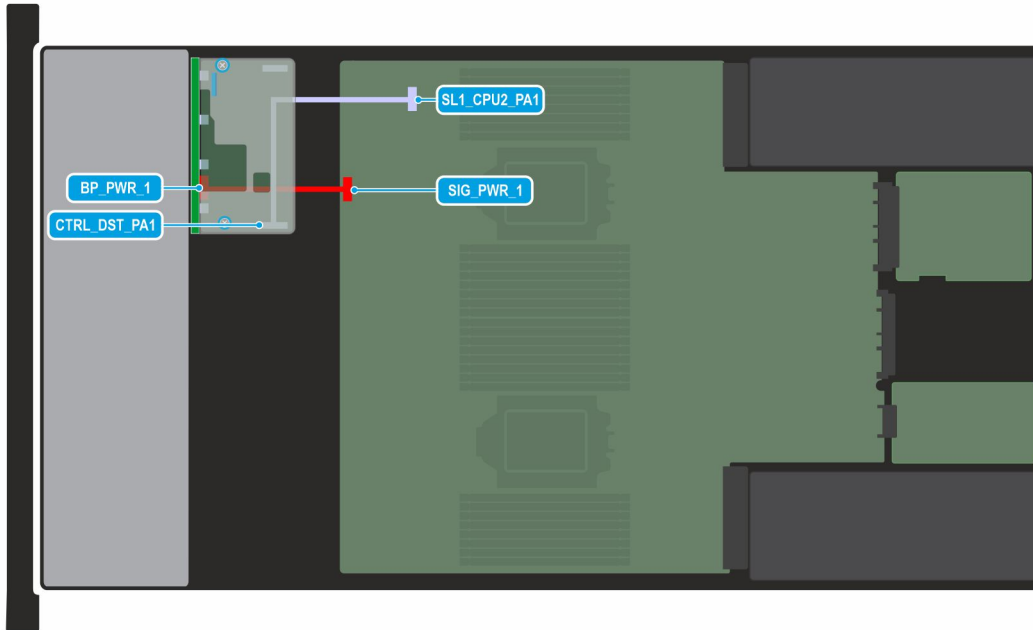

Figure 71. Configuration 1: 8 x 2.5-inch SAS/SATA with fPERC 11

NOTE: Follow the sequential order as shown in the table to remove the cables, to install the cables follow the reverse sequential order.

Table 67. 8 x 2.5-inch SAS/SATA with fPERC 11

Order	From	To
1	SL1_CPU2_PA1 (signal connector on system board)	CTRL_DST_PA1 (fPERC input connector)
2	SIG_PWR_1 (system board power connector)	BP_PWR_1 (backplane power connector)

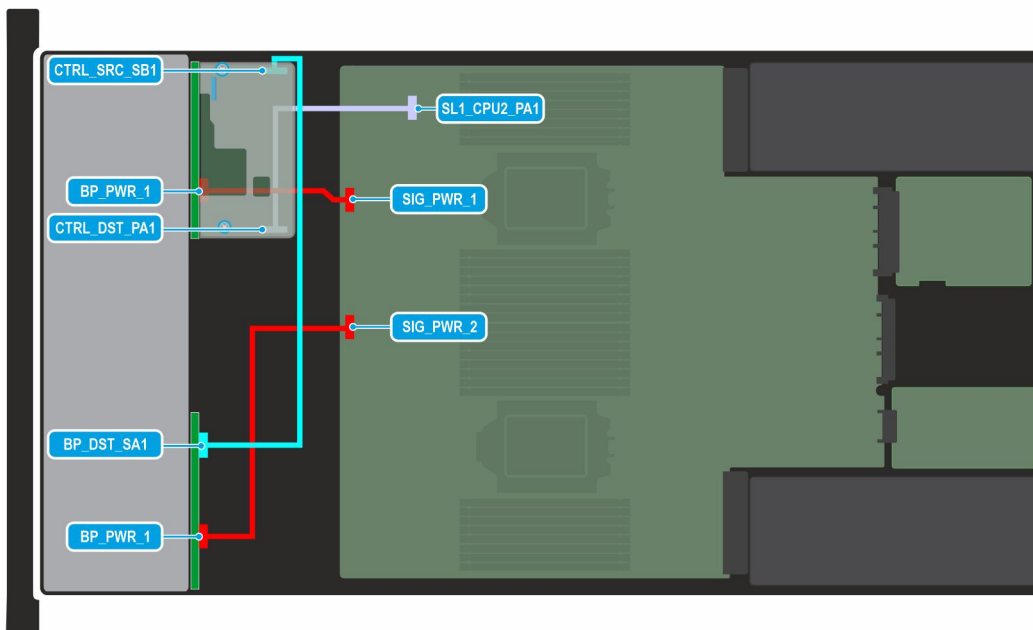

Figure 72. Configuration 2: 16 x 2.5-inch SAS/SATA with fPERC 11

NOTE: Follow the sequential order as shown in the table to remove the cables, to install the cables follow the reverse sequential order.

Table 68. 16 x 2.5-inch SAS/SATA with fPERC 11

Order	From	To
1	SL1_CPU2_PA1 (signal connector on system board)	CTRL_DST_PA1 (fPERC input connector)
2	SIG_PWR_1 (system board power connector)	BP_PWR_1 (backplane power connector)
3	CTRL_SRC_SB1 (fPERC controller connector)	BP_DST_SA1 (backplane signal connector)
4	SIG_PWR_2 (system board power connector)	BP_PWR_1 (backplane power connector)

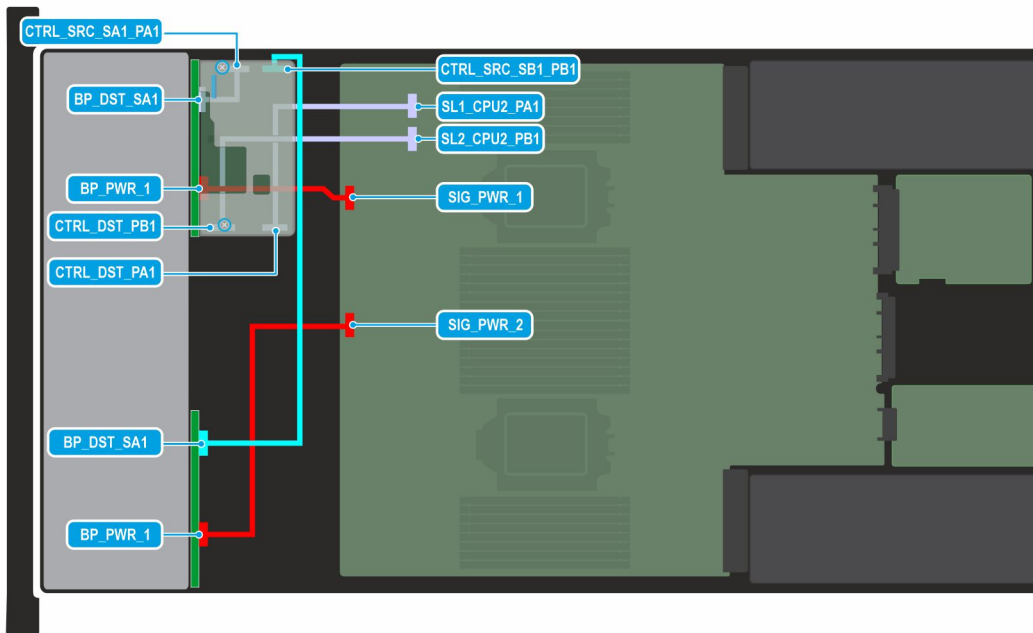

Figure 73. Configuration 3: 16 x 2.5-inch SAS/SATA with fPERC 12

Table 69. 16 x 2.5-inch SAS/SATA with fPERC 12

Order	From	To
1	SL1_CPU2_PA1 (signal connector on system board)	CTRL_DST_PA1 (fPERC input connector)
2	SL2_CPU2_PB1 (signal connector on system board)	CTRL_DST_PB1 (fPERC input connector)
3	SIG_PWR_1 (system board power connector)	BP_PWR_1 (backplane power connector)
4	CTRL_SRC_SA1_PA1 (fPERC controller connector)	BP_DST_SA1 (backplane signal connector)
5	CTRL_SRC_SB1_PB1 (fPERC controller connector)	BP_DST_SA1 (backplane signal connector)
6	SIG_PWR_2 (system board power connector)	BP_PWR_1 (backplane power connector)

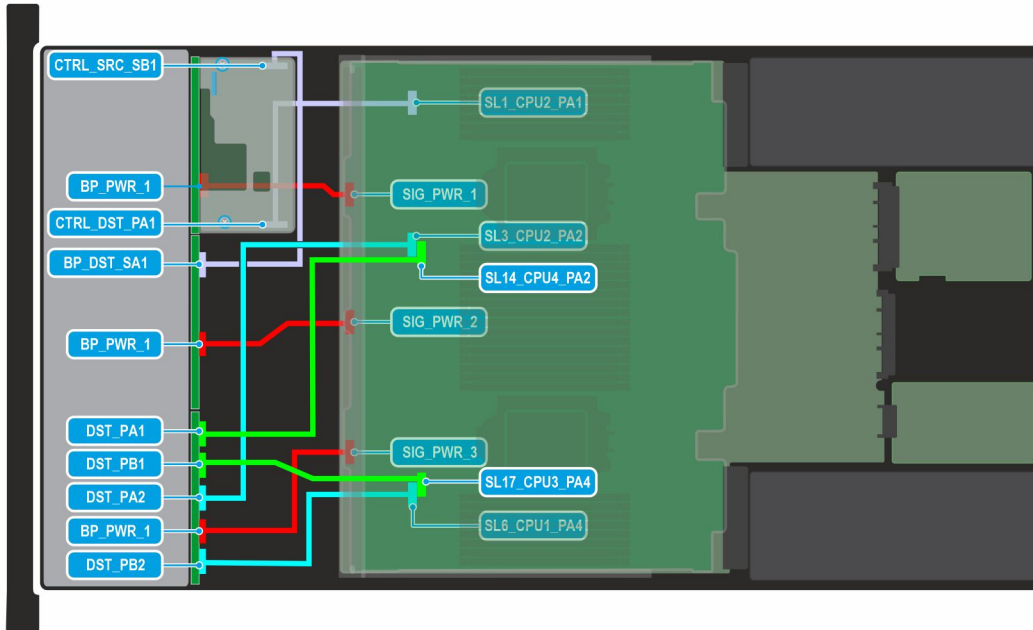

Figure 74. Configuration 4: 16 x 2.5-inch SAS/SATA + 8 x 2.5-inch NVMe with fPERC 11

NOTE: Follow the sequential order as shown in the table to remove the cables, to install the cables follow the reverse sequential order.

Table 70. 16 x 2.5-inch SAS/SATA + 8 x 2.5-inch NVMe with fPERC 11

Order	From	To
1	SL14_CPU4_PA2 (signal connector on PEM)	DST_PA1 (backplane signal connector)
2	SL17_CPU3_PA4 (signal connector on PEM)	DST_PB1 (backplane signal connector)
3	SL1_CPU2_PA1 (signal connector on system board)	CTRL_DST_PA1 (fPERC input connector)
4	CTRL_SRC_SB1 (fPERC controller connector)	BP_DST_SA1 (backplane signal connector)
5	SIG_PWR_1 (system board power connector)	BP_PWR_1 (backplane power connector)
6	SL3_CPU2_PA2 (signal connector on system board)	DST_PA1 (backplane signal connector)
7	SIG_PWR_2 (system board power connector)	BP_PWR_1 (backplane power connector)
8	SIG_PWR_3 (system board power connector)	BP_PWR_1 (backplane power connector)
9	SL6_CPU1_PA4 (signal connector on system board)	DST_PB2 (backplane power connector)

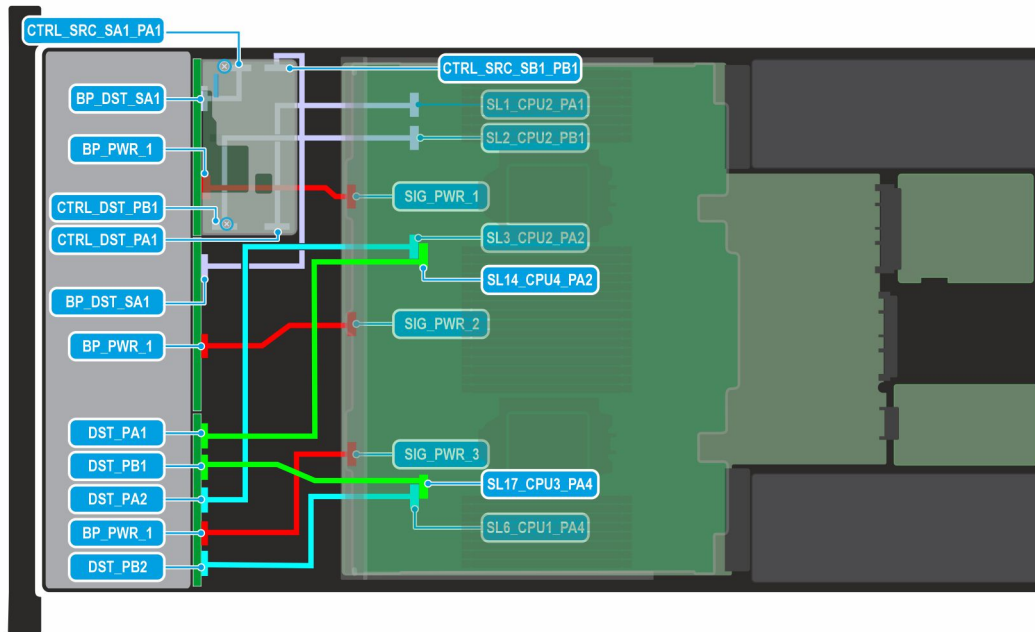

Figure 75. Configuration 5: 16 x 2.5-inch SAS/SATA + 8 x 2.5-inch NVMe with fPERC 12

NOTE: Follow the sequential order as shown in the table to remove the cables, to install the cables follow the reverse sequential order.

Table 71. 16 x 2.5-inch SAS/SATA + 8 x 2.5-inch NVMe with fPERC 12

Order	From	To
1	SL14_CPU4_PA2 (signal connector on PEM)	DST_PA1 (backplane signal connector)
2	SL17_CPU3_PA4 (signal connector on PEM)	DST_PB1 (backplane signal connector)
3	CTRL_SRC_SB1_PB1 (fPERC controller connector)	BP_DST_SA1 (backplane signal connector)
4	SL1_CPU2_PA1 (signal connector on system board)	CTRL_DST_PA1 (fPERC input connector)
5	SL2_CPU2_PB1 (signal connector on system board)	CTRL_DST_PB1 (fPERC input connector)
6	CTRL_SRC_SA1_PA1 (fPERC controller connector)	BP_DST_SA1 (backplane signal connector)
7	SIG_PWR_1 (system board power connector)	BP_PWR_1 (backplane power connector)
8	SL3_CPU2_PA2 (signal connector on system board)	DST_PA1 (backplane signal connector)
9	SIG_PWR_2 (system board power connector)	BP_PWR_1 (backplane power connector)
10	SIG_PWR_3 (system board power connector)	BP_PWR_1 (backplane power connector)
11	SL6_CPU1_PA4 (signal connector on system board)	DST_PB2 (backplane power connector)

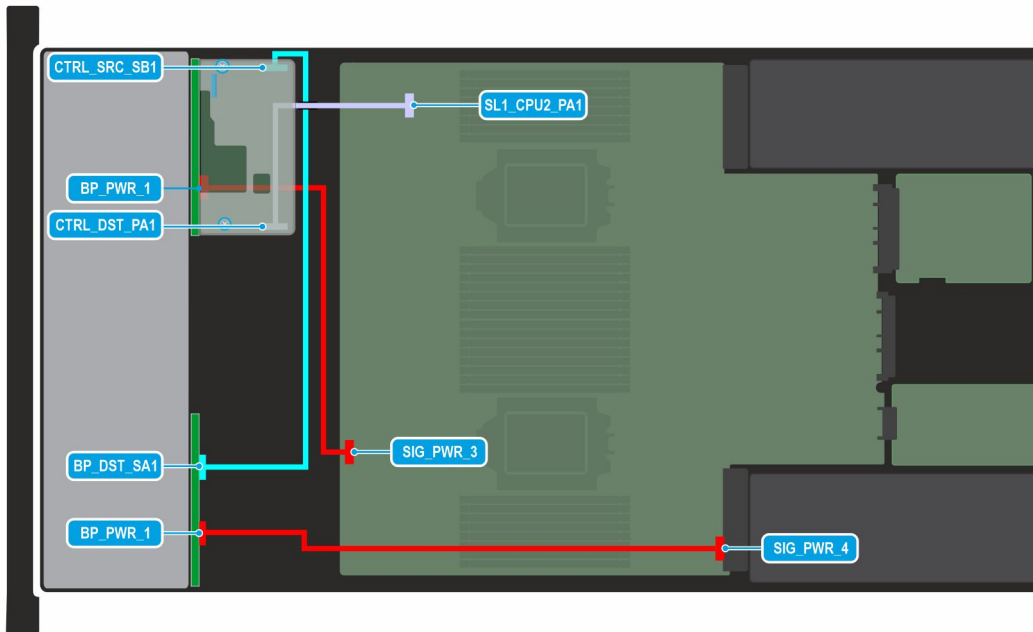

Figure 76. Configuration 6: 32 x 2.5-inch SAS/SATA with fPERC 11 (lower bay)

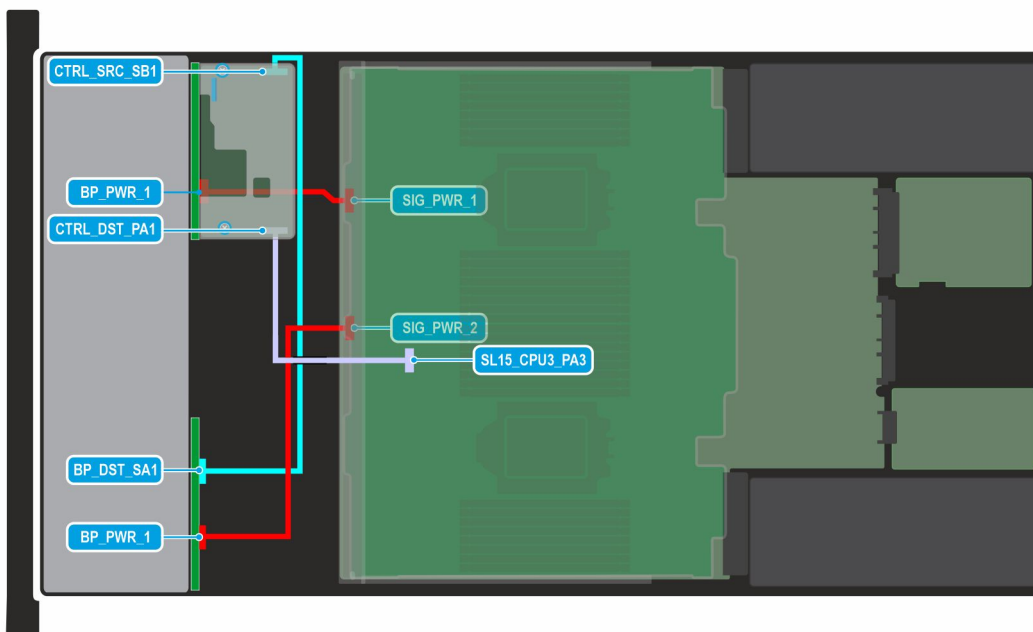

Figure 77. Configuration 6: 32 x 2.5-inch SAS/SATA with fPERC 11 (upper bay)

NOTE: Follow the sequential order as shown in the table to remove the cables, to install the cables follow the reverse sequential order.

Table 72. 32 x 2.5-inch SAS/SATA with fPERC 11 on both upper and lower bay

Order	From	To
1	SL15_CPU3_PA3 (signal connector on PEM)	CTRL_DST_PA1 (fPERC input connector)
2	CTRL_SRC_SB1 (fPERC controller connector)	BP_DST_SA1 (backplane signal connector)
3	SIG_PWR_1 (system board power connector)	BP_PWR_1 (backplane power connector)

Table 72. 32 x 2.5-inch SAS/SATA with fPERC 11 on both upper and lower bay (continued)

Order	From	To
4	SIG_PWR_2 (system board power connector)	BP_PWR_1 (backplane power connector)
5	SL1_CPU2_PA1 (signal connector on system board)	CTRL_DST_PA1 (fPERC input connector)
6	CTRL_SRC_SB1 (fPERC controller connector)	BP_DST_SA1 (backplane signal connector)
7	SIG_PWR_3 (system board power connector)	BP_PWR_1 (backplane power connector)
8	SIG_PWR_4 (PDB power connector)	BP_PWR_1 (backplane power connector)

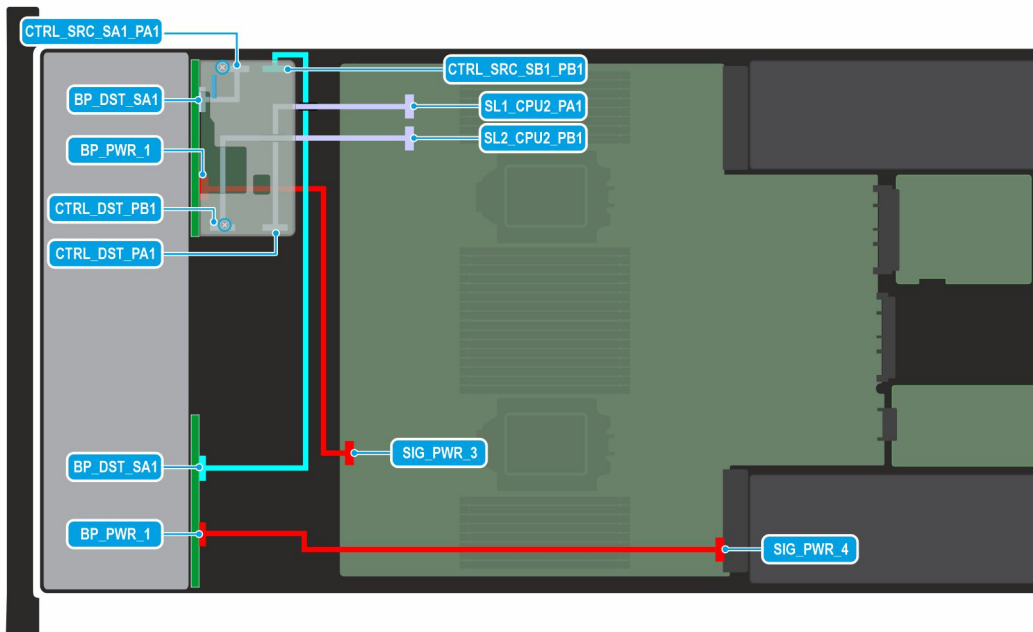

Figure 78. Configuration 7: 32 x 2.5-inch SAS/SATA with fPERC 12 (lower bay)

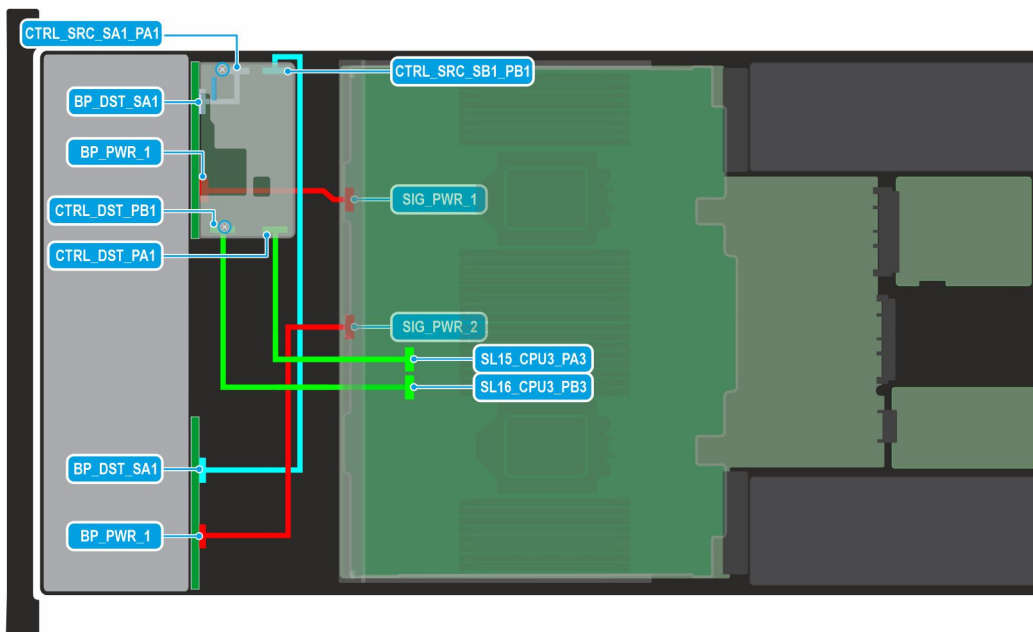

Figure 79. Configuration 7: 32 x 2.5-inch SAS/SATA with fPERC 12 (upper bay)

NOTE: Follow the sequential order as shown in the table to remove the cables, to install the cables follow the reverse sequential order.

Table 73. 32 x 2.5-inch SAS/SATA with fPERC 12 on both upper and lower bay

Order	From	To
1	SL15_CPU3_PA3 (signal connector on PEM)	CTRL_DST_PA1 (fPERC input connector)
2	SL16_CPU3_PB3 (signal connector on PEM)	CTRL_DST_PB1 (fPERC input connector)
3	CTRL_SRC_SB1_PB1 (fPERC controller connector)	BP_DST_SA1 (backplane signal connector)
4	CTRL_SRC_SA1_PA1 (fPERC controller connector)	BP_DST_SA1 (backplane signal connector)
5	SIG_PWR_1 (system board power connector)	BP_PWR_1 (backplane power connector)
6	SIG_PWR_2 (system board power connector)	BP_PWR_1 (backplane power connector)
7	SL1_CPU2_PA1 (signal connector on system board)	CTRL_DST_PA1 (fPERC input connector)
8	SL2_CPU2_PB1 (signal connector on system board)	CTRL_DST_PB1 (fPERC input connector)
9	CTRL_SRC_SB1_PB1 (fPERC controller connector)	BP_DST_SA1 (backplane signal connector)
10	CTRL_SRC_SA1_PA1 (fPERC controller connector)	BP_DST_SA1 (backplane signal connector)
11	SIG_PWR_3 (system board power connector)	BP_PWR_1 (backplane power connector)
12	SIG_PWR_4 (PDB power connector)	BP_PWR_1 (backplane power connector)

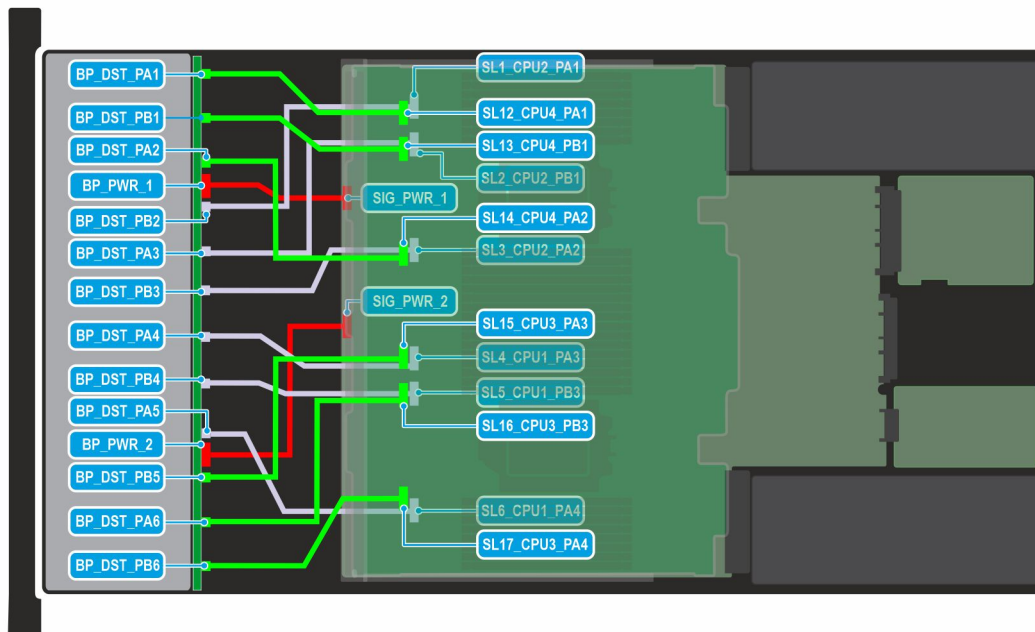

Figure 80. Configuration 8: 24 x 2.5-inch (NVMe Gen4) Passive

NOTE: Follow the sequential order as shown in the table to remove the cables, to install the cables follow the reverse sequential order.

Table 74. 24 x 2.5-inch (NVMe Gen4) Passive

Order	From	To
1	SL12_CPU4_PA1 (signal connector on PEM)	BP_DST_PA1 (backplane signal connector)
2	SL13_CPU4_PB1 (signal connector on PEM)	BP_DST_PB1 (backplane signal connector)

Table 74. 24 x 2.5-inch (NVMe Gen4) Passive (continued)

Order	From	To
3	SL14_CPU4_PA2 (signal connector on PEM)	BP_DST_PA2 (backplane signal connector)
4	SL15_CPU3_PA3 (signal connector on PEM)	BP_DST_PB5 (backplane signal connector)
5	SL16_CPU3_PB3 (signal connector on PEM)	BP_DST_PA6 (backplane signal connector)
6	SL17_CPU3_PA4 (signal connector on PEM)	BP_DST_PB6 (backplane signal connector)
7	SL1_CPU2_PA1 (signal connector on system board)	BP_DST_PB2 (backplane signal connector)
8	SL2_CPU2_PB1 (signal connector on system board)	BP_DST_PA3 (backplane signal connector)
9	SIG_PWR_1 (system board power connector)	BP_PWR_1 (backplane power connector)
10	SL3_CPU2_PA2 (signal connector on system board)	BP_DST_PB3 (backplane signal connector)
11	SIG_PWR_2 (system board power connector)	BP_PWR_2 (backplane power connector)
12	SL4_CPU1_PA3 (signal connector on system board)	BP_DST_PA4 (backplane signal connector)
13	SL5_CPU1_PB3 (signal connector on system board)	BP_DST_PB4 (backplane signal connector)
14	SL6_CPU1_PA4 (signal connector on system board)	BP_DST_PA5 (backplane signal connector)

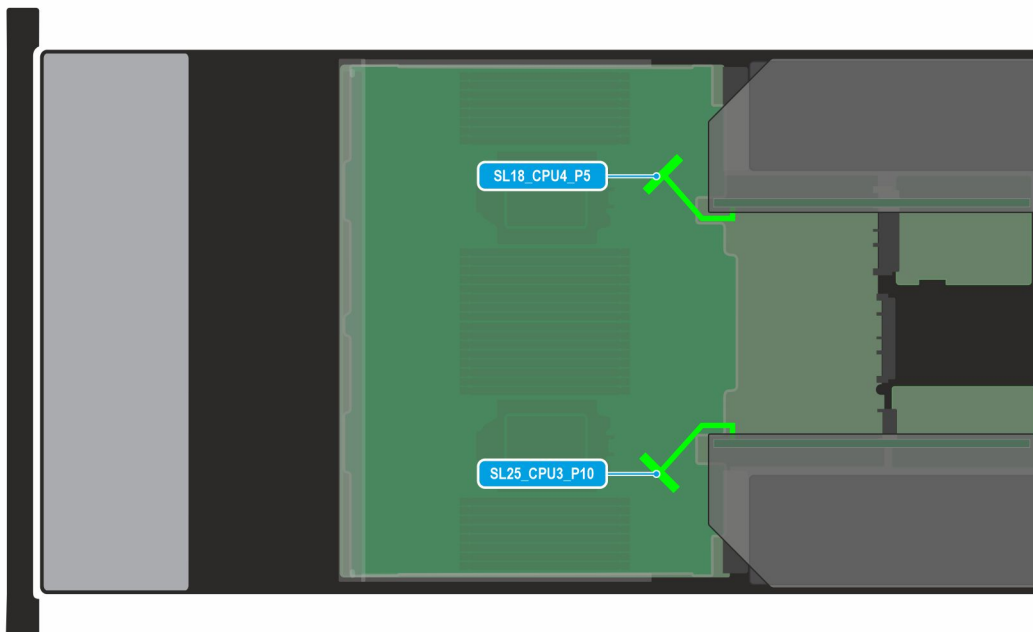

Figure 81. Configuration 9: Basic entry riser configuration

Table 75. Basic entry riser configuration

Order	From	To
1	Riser 1C	SL25_CPU3_P10 (signal connector on PEM)
2	Riser 4C	SL18_CPU4_P5 (signal connector on PEM)

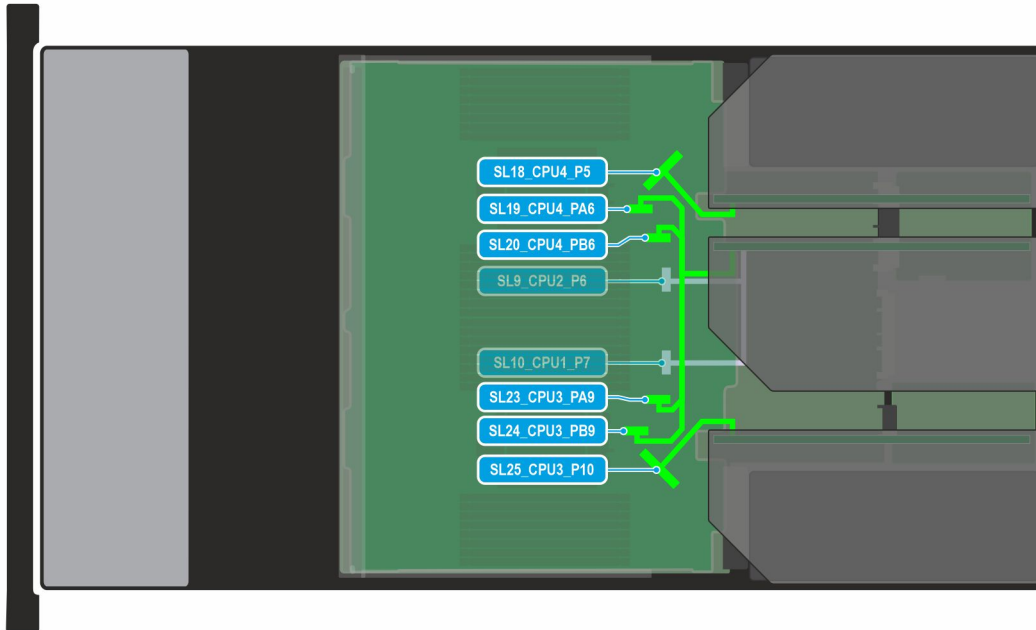

Figure 82. Configuration 10: Scale out riser configuration

Table 76. Scale out riser configuration

Order	From	To
1	Riser 1C	SL25_CPU3_P10 (signal connector on PEM)
2	Riser 3B	SL24_CPU3_PB9 (signal connector on PEM)
		SL23_CPU3_PA9 (signal connector on PEM)
		SL20_CPU4_PB6 (signal connector on PEM)
		SL19_CPU4_PA6 (signal connector on PEM)
		SL9_CPU2_P6 (signal connector on system board)
		SL10_CPU1_P7 (signal connector on system board)
3	Riser 4C	SL18_CPU4_P5 (signal connector on PEM)

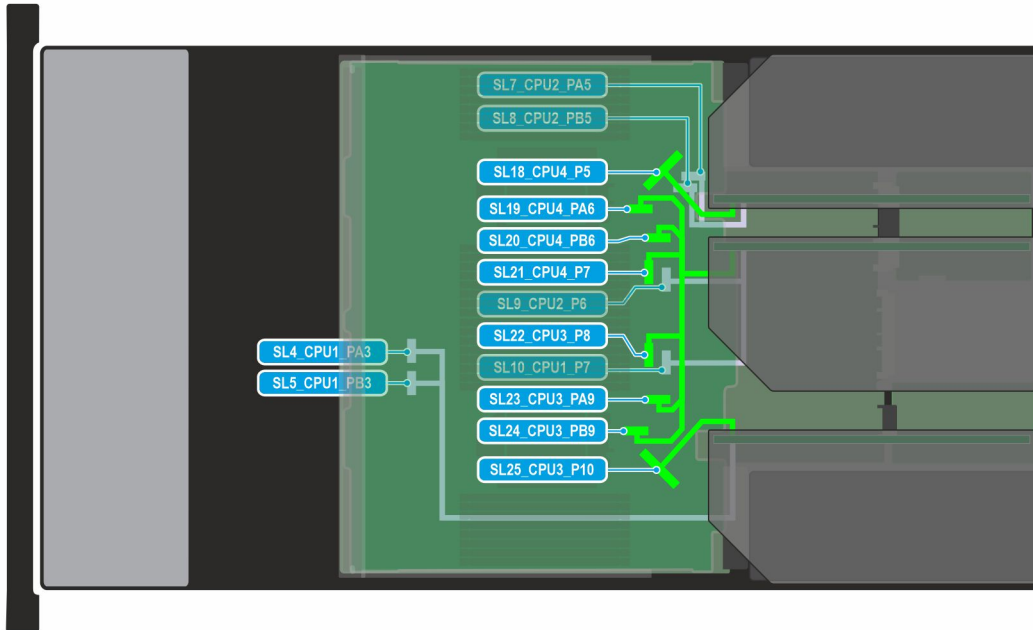

Figure 83. Configuration 11: Maximum I/O riser configuration

Table 77. Maximum I/O riser configuration

Order	From	To
1	Riser 1B	SL25_CPU3_P10 (signal connector on PEM)
		SL5_CPU1_PB3 (signal connector on system board)
		SL4_CPU1_PA3 (signal connector on system board)
2	Riser 2	SL9_CPU2_P6 (signal connector on system board)
		SL10_CPU1_P7 (signal connector on system board)
3	Riser 3B	SL24_CPU3_PB9 (signal connector on PEM)
		SL23_CPU3_PA9 (signal connector on PEM)
		SL22_CPU3_P8 (signal connector on PEM)
		SL21_CPU4_P7 (signal connector on PEM)
		SL20_CPU4_PB6 (signal connector on PEM)
		SL19_CPU4_PA6 (signal connector on PEM)
4	Riser 4B	SL18_CPU4_P5 (signal connector on PEM)
		SL8_CPU2_PB5 (signal connector on system board)
		SL7_CPU1_PA5 (signal connector on system board)

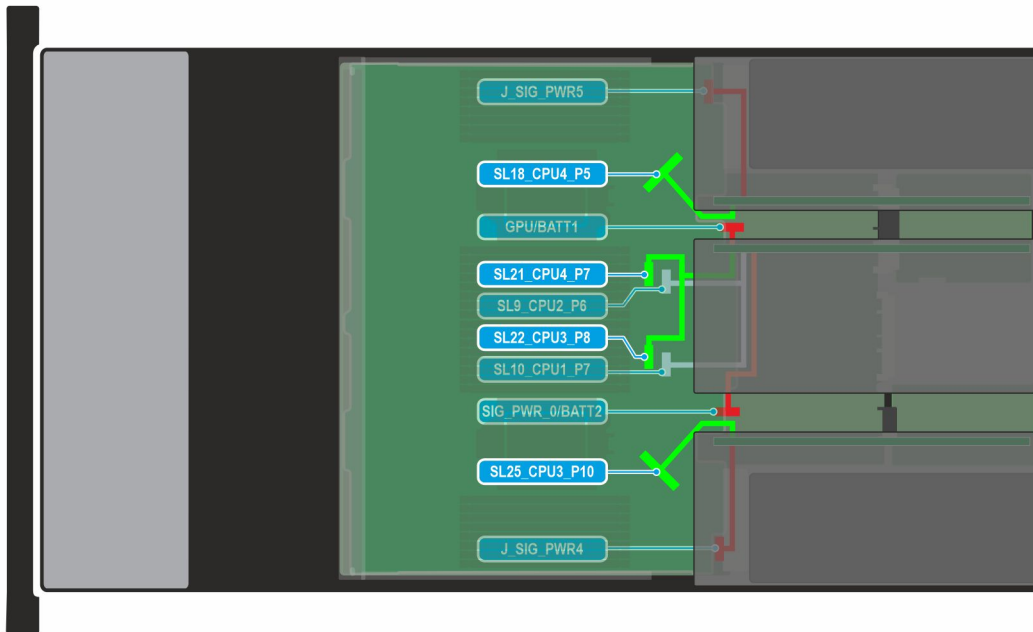

Figure 84. Configuration 12: GPU ready riser configuration

Table 78. GPU ready riser configuration

Order	From	To
1	Riser 1A	SL25_CPU3_P10 (signal connector on PEM)
2	J_SIG_PRW4 (right PDB power connector)	GPU1 in riser 1A (power connector on GPU1)
3	Riser 2	SL9_CPU2_P6 (signal connector on system board)
		SL10_CPU1_P7 (signal connector on system board)
4	Riser 3A	SL22_CPU3_P8 (signal connector on PEM)
		SL21_CPU4_P7 (signal connector on PEM)
5	SIG_PWR_0/BATT2 (power connector on system board)	GPU2 in riser 3A (power connector on GPU2)
6	GPU/BATT1 (power connector on system board)	GPU3 in riser 3A (power connector on GPU3)
7	Riser 4A	SL18_CPU4_P5 (signal connector on PEM)
8	J_SIG_PRW4 (left PDB power connector)	GPU4 in riser 4A (power connector on GPU4)

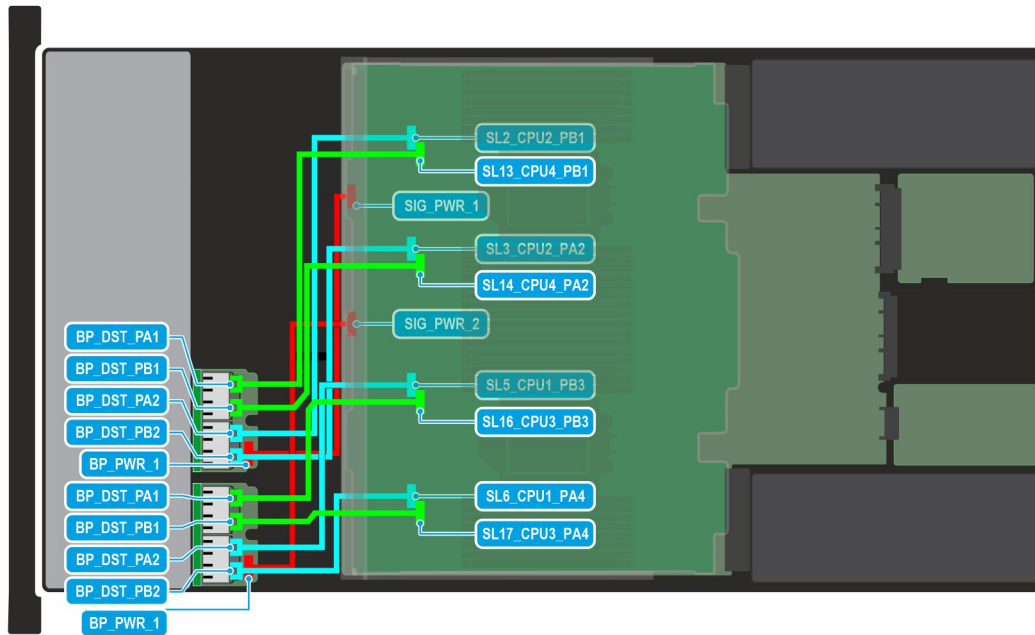

Figure 85. Configuration 13: 16 x EDSFF E3.S NVMe

NOTE: Follow the sequential order as shown in the table to remove the cables, to install the cables follow the reverse sequential order.

Table 79. 16 x EDSFF E3.S NVMe

Order	From	To
1	SL13_CPU4_PB1 (signal connector on PEM)	BP_DST_PA1 (backplane signal connector)
2	SL14_CPU4_PA2 (signal connector on PEM)	BP_DST_PB1 (backplane signal connector)
3	SL16_CPU3_PB3 (signal connector on PEM)	BP_DST_PA1 (backplane signal connector)
4	SL17_CPU3_PA4 (signal connector on PEM)	BP_DST_PB1 (backplane signal connector)
5	SL2_CPU2_PB1 (signal connector on system board)	BP_DST_PA2 (backplane signal connector)
6	SL3_CPU2_PA2 (signal connector on system board)	BP_DST_PB2 (backplane signal connector)
7	SL5_CPU1_PB3 (signal connector on system board)	BP_DST_PA2 (backplane signal connector)
8	SL6_CPU1_PA4 (signal connector on system board)	BP_DST_PB2 (backplane signal connector)
9	SIG_PWR_1 (system board power connector)	BP_PWR_1 (backplane power connector)
10	SIG_PWR_2 (system board power connector)	BP_PWR_1 (backplane power connector)

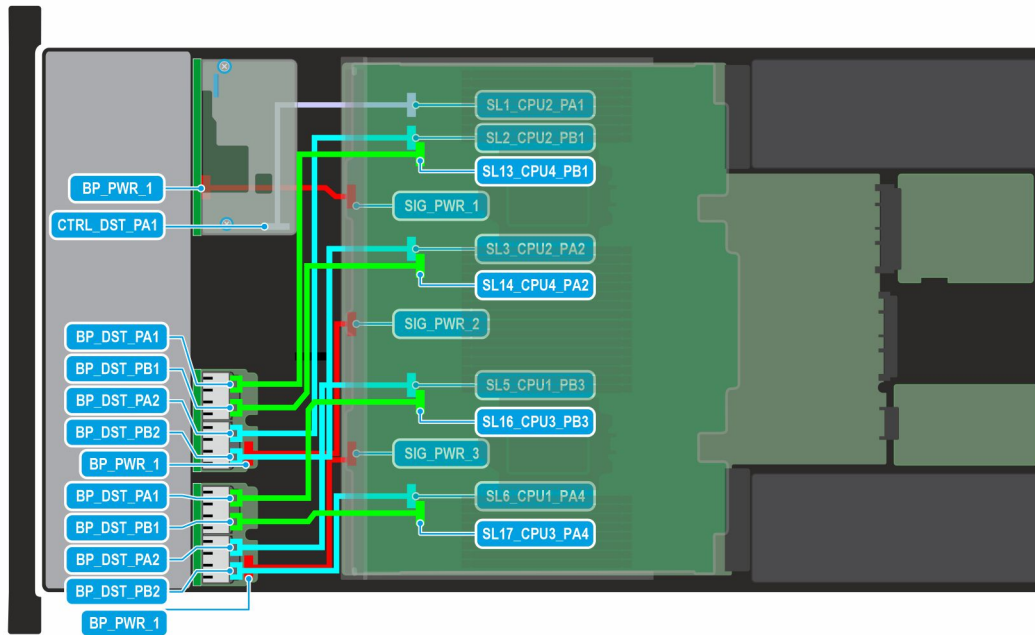

Figure 86. 16 x EDSFF E3.S NVMe + 8 x 2.5-inch SAS/SATA with fPERC 11

NOTE: Follow the sequential order as shown in the table to remove the cables, to install the cables follow the reverse sequential order.

Table 80. 16 x EDSFF E3.S NVMe + 8 x 2.5-inch SAS/SATA with fPERC 11

Order	From	To
1	SL13_CPU4_PB1 (signal connector on PEM)	BP_DST_PA1 (backplane signal connector)
2	SL14_CPU4_PA2 (signal connector on PEM)	BP_DST_PB1 (backplane signal connector)
3	SL16_CPU3_PB3 (signal connector on PEM)	BP_DST_PA1 (backplane signal connector)
4	SL17_CPU3_PA4 (signal connector on PEM)	BP_DST_PB1 (backplane signal connector)
5	SIG_PWR_1 (system board power connector)	BP_PWR_1 (backplane power connector)
6	SL1_CPU2_PA1 (signal connector on system board)	CTRL_DST_PA1 (fPERC input connector)
7	SL2_CPU2_PB1 (signal connector on system board)	BP_DST_PA2 (backplane signal connector)
8	SL3_CPU2_PA2 (signal connector on system board)	BP_DST_PB2 (backplane signal connector)
9	SL5_CPU1_PB3 (signal connector on system board)	BP_DST_PA2 (backplane signal connector)
10	SL6_CPU1_PA4 (signal connector on system board)	BP_DST_PB2 (backplane signal connector)
11	SIG_PWR_1 (system board power connector)	BP_PWR_1 (backplane power connector)
12	SIG_PWR_3 (system board power connector)	BP_PWR_1 (backplane power connector)

PERC module

This is a service technician replaceable part only.

Removing the rear mounting front PERC module

Prerequisites

1. Follow the safety guidelines listed in the [Safety instructions](#).
2. Follow the procedure listed in the [Before working inside your system](#).
3. [Remove the support bar](#).
4. [Remove the air shroud top cover](#).
5. [Remove the cooling fan cage assembly](#).
6. If required, [remove the air shroud](#) or [remove the GPU air shroud](#).
7. Disconnect the cables, observe the cable routing.
i **NOTE:** See [cable routing](#) section for more information.
8. If required, [remove the PEM](#).

Steps

1. Using a Phillips #2 screwdriver, loosen the captive screws on the rear mounting front PERC module.
2. Slide the rear mounting front PERC module to disengage from the connector on the drive backplane.

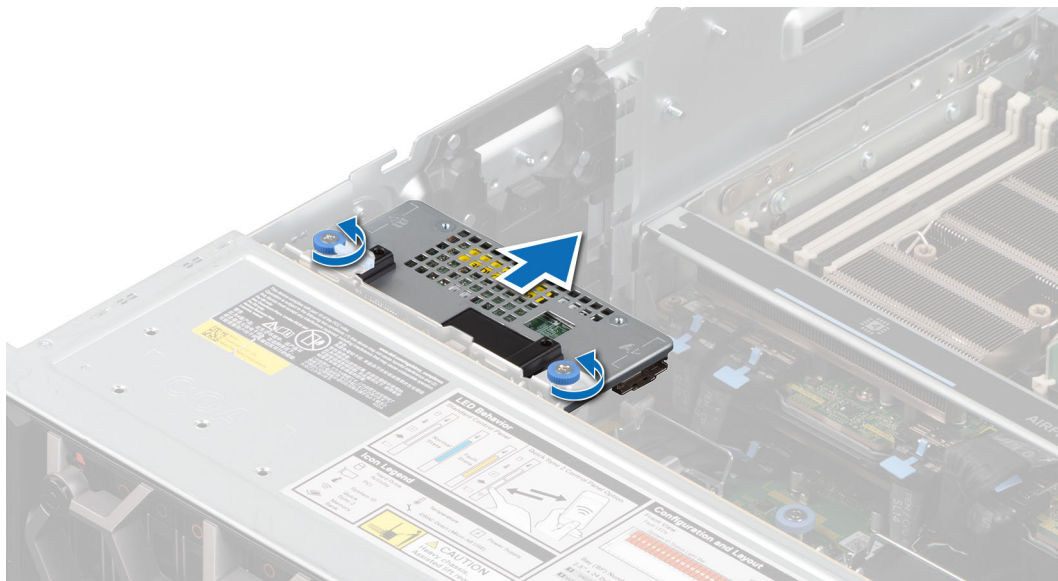

Figure 87. Removing the rear mounting front PERC module

Next steps

1. [Replace the rear mounting front PERC module](#).

Installing the rear mounting front PERC module

Prerequisites

1. Follow the safety guidelines listed in the [Safety instructions](#).
2. Follow the procedure listed in the [Before working inside your system](#).
3. [Remove the support bar](#).
4. [Remove the air shroud top cover](#).

5. Remove the cooling fan cage assembly.
6. If required, [remove the air shroud](#) or [remove the GPU air shroud](#).
7. Disconnect the cables, observe the cable routing.
8. If required, [remove the PEM](#).

NOTE: See [cable routing](#) section for more information.

Steps

1. Align the connectors and guide slots on the rear mounting front PERC module with the connectors and guide pins on the drive backplane.
2. Slide the rear mounting front PERC module until the module is connected to the drive backplane.
3. Using a Phillips #2 screwdriver, tighten the captive screws on the rear mounting front PERC module.

NOTE: The numbers on the image do not depict the exact steps. The numbers are for representation of sequence.

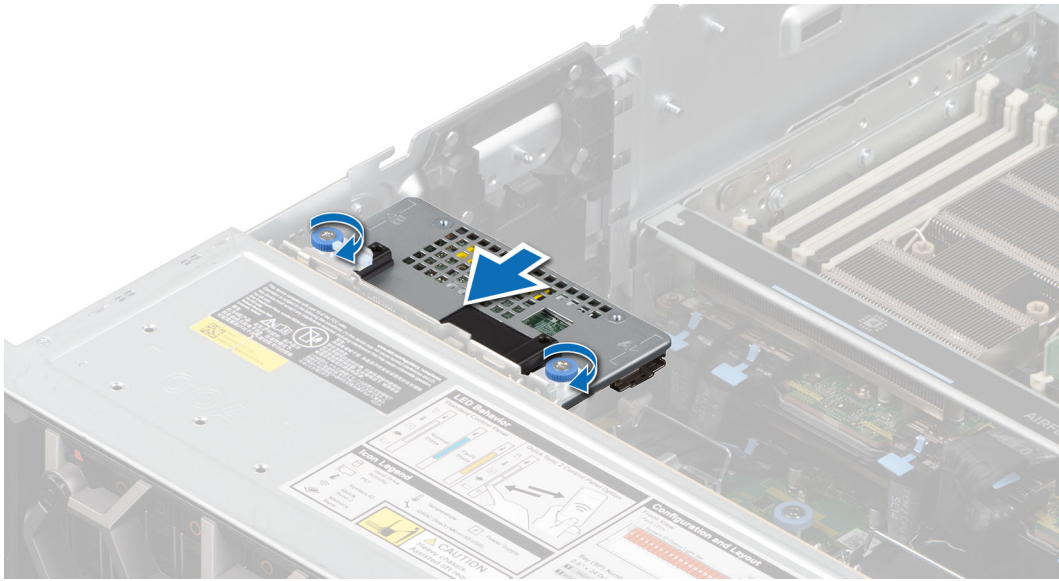

Figure 88. Installing the rear mounting front PERC module

Next steps

1. Connect the cables, observe the cable routing.
2. If removed, [install the PEM](#).
3. If removed, [install the air shroud](#) or [install the GPU air shroud](#).
4. [Install the cooling fan cage assembly](#).
5. [Install the air shroud top cover](#).
6. [Install the support bar](#).
7. Follow the procedure listed in [After working inside your system](#).

EDSFF E3.S backplane module

This is a service technician replaceable part only.

Removing the EDSFF E3.S backplane module

Prerequisites

1. Follow the safety guidelines listed in the [Safety instructions](#).
2. Follow the procedure listed in the [Before working inside your system](#).

3. Remove the front bezel.
4. Remove the EDSFF E3.S drives.
5. Remove the support bar.
6. Remove the air shroud top cover.
7. Remove the cooling fan cage assembly.
8. If required, remove the air shroud or remove the GPU air shroud.
9. Disconnect the cables, observe the cable routing.

NOTE: See [cable routing](#) section for more information.

10. Remove the PEM.

Steps

1. Using a Phillips #2 screwdriver, loosen the captive screws on the EDSFF E3.S backplane module.
2. Slide and remove the EDSFF E3.S backplane module from the system.

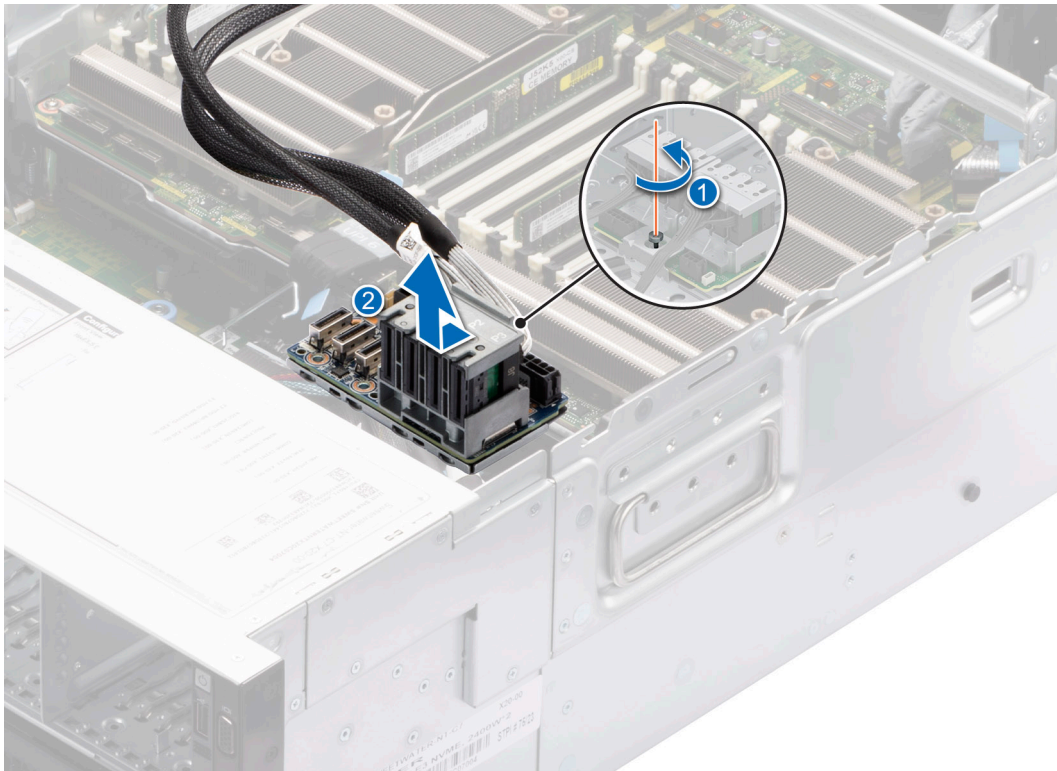

Figure 89. Removing the EDSFF E3.S backplane module

Next steps

1. [Replace the EDSFF E3.S backplane module.](#)

Installing the EDSFF E3.S backplane module

Prerequisites

1. Follow the safety guidelines listed in the [Safety instructions](#).
2. Follow the procedure listed in the [Before working inside your system](#).
3. [Remove the front bezel.](#)
4. [Remove the EDSFF E3.S drives.](#)
5. [Remove the support bar.](#)
6. [Remove the air shroud top cover.](#)
7. [Remove the cooling fan cage assembly.](#)

8. If required, [remove the air shroud](#) or [remove the GPU air shroud](#).
9. Disconnect the cables, observe the cable routing.
i **NOTE:** See [cable routing](#) section for more information.
10. [Remove the PEM](#).

Steps

1. Align the guides on the EDSFF E3.S backplane module with the slots on the system.
2. Slide the EDSFF E3.S backplane module towards the rear of the system, until it is firmly secured.
3. Using a Phillips #2 screwdriver, tighten the captive screw on the EDSFF E3.S backplane module.

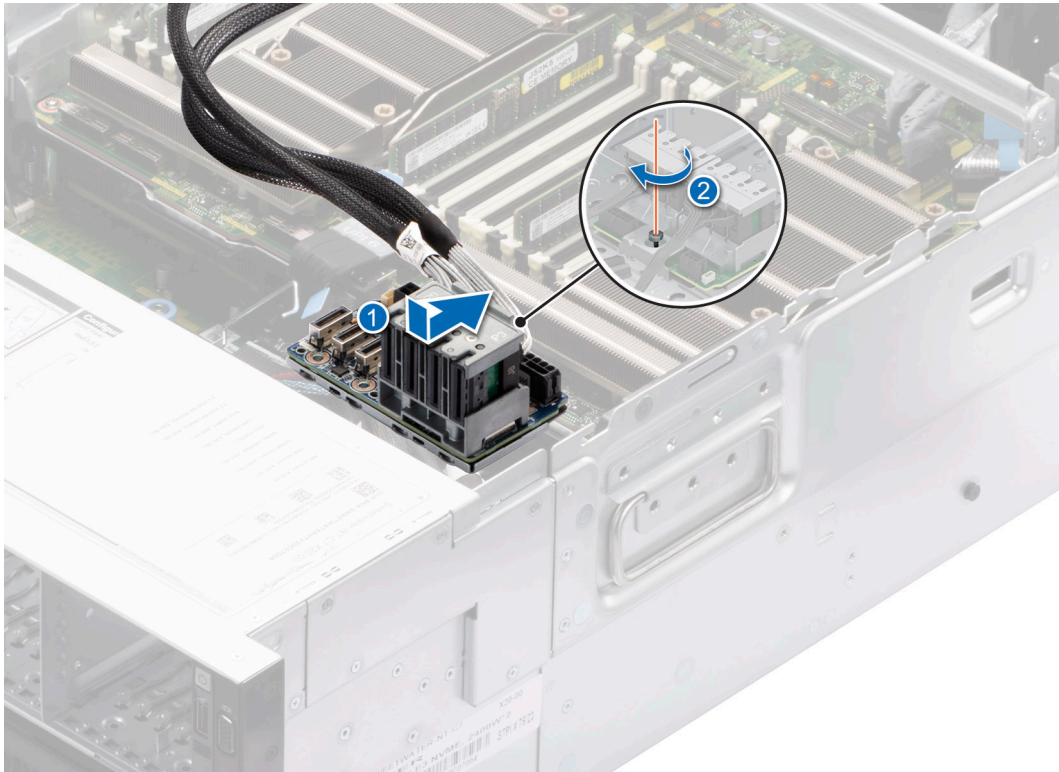

Figure 90. Installing the EDSFF E3.S backplane module

Next steps

1. Connect all the cables, observe the cable routing.
i **NOTE:** See [cable routing](#) section for more information.
2. If removed, [install the PEM](#).
3. If removed, [install the air shroud](#) or [install the GPU air shroud](#).
4. [Install the cooling fan cage assembly](#).
5. [Install the air shroud top cover](#).
6. [Install the support bar](#).
7. [Install the EDSFF E3.S drives](#).
8. [Install the front bezel](#).
9. Follow the procedure listed in [After working inside your system](#).

System memory

System memory guidelines

The PowerEdge R960 system supports DDR5 registered DIMMs (RDIMMs).

Your system memory is organized into eight channels per processor (two memory sockets per channel), 16 memory sockets per processor and 64 memory sockets (32 sockets each on system board and PEM) per system.

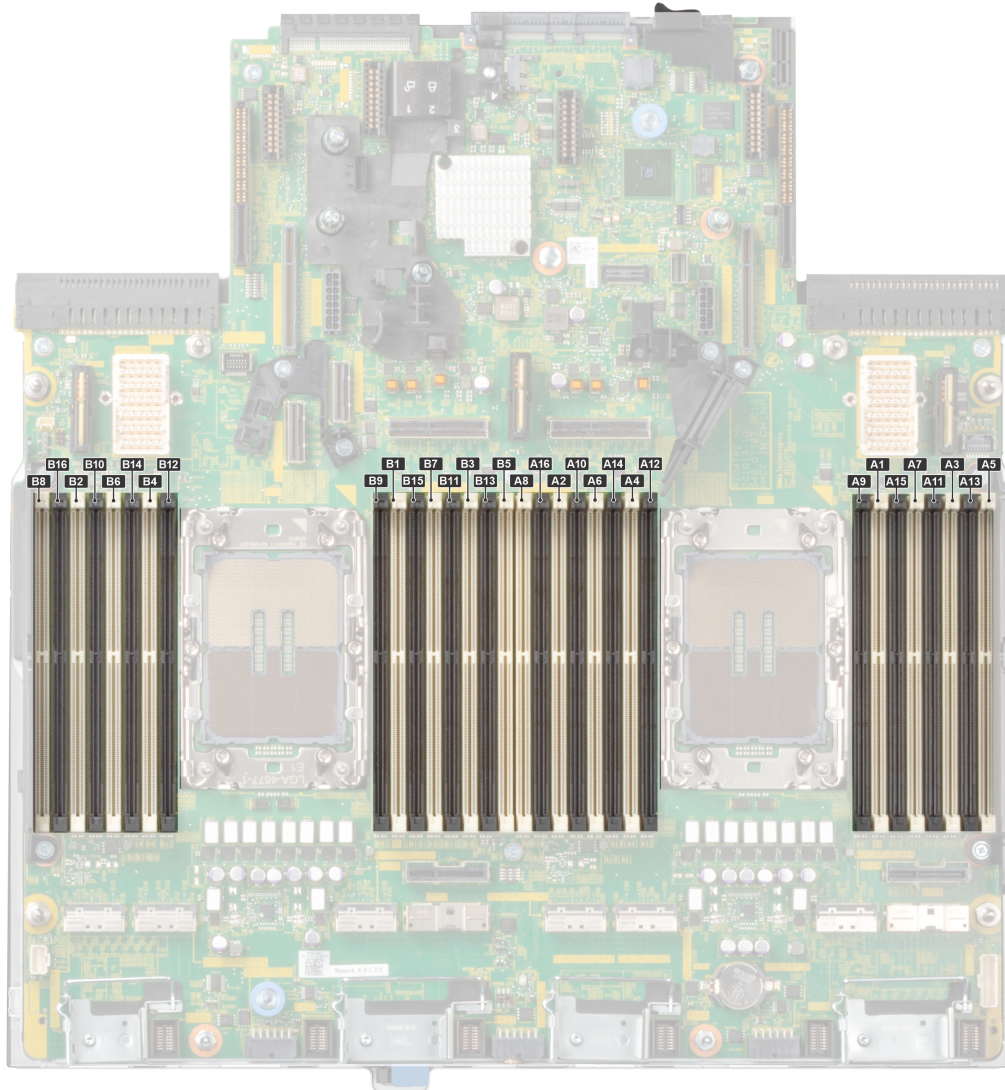

Figure 91. Memory channels on system board

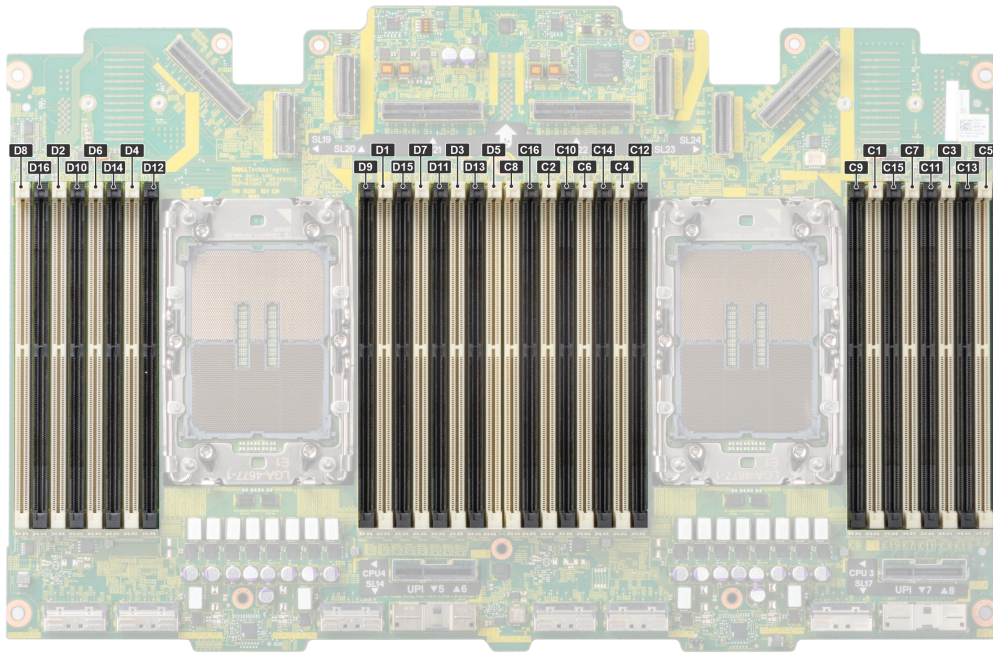

Figure 92. Memory channels on Processor Expansion Module (PEM)board

Memory channels are organized as follows:

Table 81. Memory channels

Processor	Channel A	Channel B	Channel C	Channel D	Channel E	Channel F	Channel G	Channel H
Processor 1	Slots A1 and A9	Slots A7 and A15	Slots A3 and A11	Slots A5 and A13	Slots A4 and A12	Slots A6 and A14	Slots A2 and A10	Slots A8 and A16
Processor 2	Slots B1 and B9	Slots B7 and B15	Slots B3 and B11	Slots B5 and B13	Slots B4 and B12	Slots B6 and B14	Slots B2 and B10	Slots B8 and B16
Processor 3	Slots C1 and C9	Slots C7 and C15	Slots C3 and C11	Slots C5 and C13	Slots C4 and C12	Slots C6 and C14	Slots C2 and C10	Slots C8 and C16
Processor 4	Slots D1 and D9	Slots D7 and D15	Slots D3 and D11	Slots D5 and D13	Slots D4 and D12	Slots D6 and D14	Slots D2 and D10	Slots D8 and D16

Table 82. Supported memory matrix

DIMM type	Rank	Capacity	DIMM rated voltage and speed	Operating Speed	
				1 DIMM per channel (DPC)	2 DIMMs per channel (DPC)
RDIMM	1 R	16 GB	DDR5 (1.1 V), 4800 MT/s	4800 MT/s	4400 MT/s
	2 R	32 GB, 64 GB	DDR5 (1.1 V), 4800 MT/s	4800 MT/s	4400 MT/s
	4 R	128 GB	DDR5 (1.1 V), 4800 MT/s	4800 MT/s	4400 MT/s
	8 R	256 GB	DDR5 (1.1 V), 4800 MT/s	4800 MT/s	4400 MT/s

NOTE: The processor may reduce the performance of the rated DIMM speed.

General memory module installation guidelines

To ensure optimal performance of your system, observe the following general guidelines when configuring your system memory. If your system's memory configuration fails to observe these guidelines, your system might not boot, stop responding during memory configuration, or operate with reduced memory.

The memory bus may operate at speeds of 4800 MT/s, 4400 MT/s, or 4000 MT/s depending on the following factors:

- System profile selected (for example, Performance, Performance Per Watt Optimized (OS), or Custom [can be run at high speed or lower])
- Maximum supported DIMM speed of the processors
- Maximum supported speed of the DIMMs

NOTE: MT/s indicates DIMM speed in MegaTransfers per second.

NOTE: Fault Resilient Memory supports only eight and sixteen DIMMs per processor.

- All DIMMs must be DDR5.
- Memory mixing is not supported for:
 - Different DIMM capacities
 - X4 and X8 DRAM memory modules
 - 3DS and non-3DS RDIMMs
- **NOTE:** 3DS is a DRAM technology that is used to manufacture the highest capacity DIMMs. See your DIMM documentation for additional details.
- If memory modules with different speeds are installed, they operate at the speed of the slowest installed memory module(s).
- Populate memory module sockets only if a processor is installed.
 - For dual-processor systems, sockets A1 to A16 and sockets B1 to B16 are available.
 - For quad-processor systems, sockets A1 to A16, sockets B1 to B16, sockets C1 to C16 and sockets D1 to D16 are available.
 - A minimum of one DIMM must be populated for each installed processor.
- In **Optimizer Mode**, the DRAM controllers operate independently in the 64-bit mode and provide optimized memory performance.

Table 83. Memory population rules

Processor	Memory population	Memory population information
Dual processor (Start with processor1. Processor 1 and processor 2 population should match)	A{1}, B{1}, A{2}, B{2}, A{3}, B{3}, A{4}, B{4}, A{5}, B{5}, A{6}, B{6}, A{7}, B{7}, A{8}, B{8}, A{9}, B{9}, A{10}, B{10}, A{11}, B{11}, A{12}, B{12}, A{13}, B{13}, A{14}, B{14}, A{15}, B{15}, A{16}, B{16}	2, 4, 8, 12, 16, 24, or 32 DIMMs are supported per system.
Quad processor (Start with processor1. Processor 1, Processor 2, Processor 3 and processor 4 population should match)	A{1}, B{1}, C{1}, D{1}, A{2}, B{2}, C{2}, D{2}, A{3}, B{3}, C{3}, D{3}, A{4}, B{4}, C{4}, D{4}, A{5}, B{5}, C{5}, D{5}, A{6}, B{6}, C{6}, D{6}, A{7}, B{7}, C{7}, D{7}, A{8}, B{8}, C{8}, D{8}, A{9}, B{9}, C{9}, D{9}, A{10}, B{10}, C{10}, D{10}, A{11}, B{11}, C{11}, D{11}, A{12}, B{12}, C{12}, D{12}, A{13}, B{13}, C{13}, D{13}, A{14}, B{14}, C{14}, D{14}, A{15}, B{15}, C{15}, D{15}, A{16}, B{16}, C{16}, D{16}	4, 8, 16, 24, 32, 48, or 64 DIMMs are supported per system.

- Populate all the sockets with white release tabs first, followed by the sockets with black release tabs.
- Unbalanced or odd memory configurations result in a performance loss, and the system may not identify the memory modules being installed. Always populate memory channels identically with equal DIMMs for the best performance.
- Supported RDIMM configurations are 1, 2, 4, 6, 8, 12, or 16 DIMMs per processor.

Removing a memory module

Prerequisites

1. Follow the safety guidelines listed in the [Safety instructions](#).
2. Follow the procedure listed in [Before working inside your system](#).
3. [Remove the support bar](#).
4. [Remove the air shroud top cover](#).
5. [Remove the cooling fan cage assembly](#).
6. [Remove the air shroud](#) or [remove the GPU air shroud](#).
i **NOTE:** The GPU air shroud can be removed only after the full length expansion card risers have been removed.
7. If installed, [Remove the full length expansion card risers](#).
8. [Remove the PEM](#), if system board memory modules must be accessed.

⚠ **WARNING:** The memory modules are hot to touch for some time after the system has been powered off. Allow the memory modules to cool before handling them.

i **NOTE:** To ensure proper system cooling, memory module blanks must be installed in any memory socket that is not populated. The memory module blanks compatible with the R960 are DDR5-gray color blanks. Remove the memory module blanks only if you intend to install memory module in these sockets.

Steps

1. Locate the appropriate memory module socket.
2. To release the memory module from the socket, simultaneously press the ejectors on both ends of the memory module socket to fully open.

⚠ **CAUTION:** Handle each memory module only by the card edges, ensuring not to touch the middle of the memory module or metallic contacts.

3. Lift the memory module away from the system.

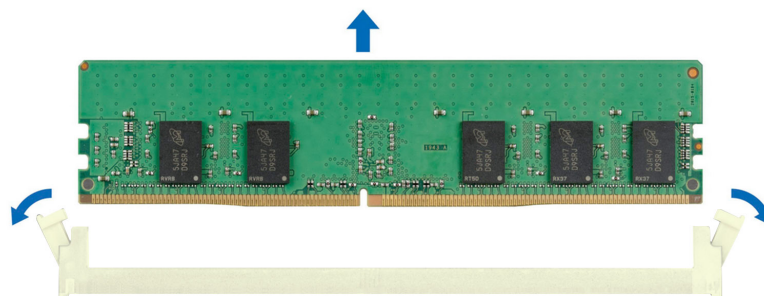

Figure 93. Removing a memory module

Next steps

[Replace the memory module.](#)

Installing a memory module

Prerequisites

1. Follow the safety guidelines listed in the [Safety instructions](#).
2. Follow the procedure listed in [Before working inside your system](#).
3. [Remove the support bar](#).
4. [Remove the air shroud top cover](#).
5. [Remove the cooling fan cage assembly](#).
6. [Remove the air shroud](#) or [remove the GPU air shroud](#).
i **NOTE:** The GPU air shroud can be removed only after the full length expansion card risers have been removed.
7. If installed, [Remove the full length expansion card risers](#).
8. [Remove the PEM](#), if system board memory modules must be accessed.

Steps

1. Locate the appropriate memory module socket.
△ CAUTION: Handle each memory module only by the card edges, ensuring not to touch the middle of the memory module or metallic contacts.
i **NOTE:** Ensure that the socket ejector latches are fully open before installing the memory module.
2. Align the edge connector of the memory module with the alignment key of the memory module socket, and insert the memory module in the socket.
△ CAUTION: To prevent damage to the memory module or the memory module socket during installation, do not bend or flex the memory module; insert both ends of the memory module simultaneously.
i **NOTE:** The memory module socket has an alignment key that enables you to install the memory module in the socket in only one orientation.
△ CAUTION: Do not apply pressure at the center of the memory module; apply pressure at both ends of the memory module evenly.
3. Press the memory module with your thumbs until the ejectors firmly click into place. When the memory module is properly seated in the socket, the levers on the memory module socket align with the levers on the other sockets that have memory modules that are installed.

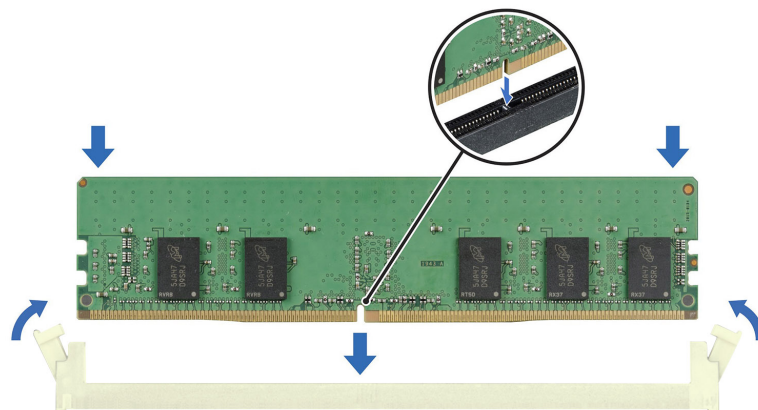

Figure 94. Installing a memory module

Next steps

1. If removed, [install the PEM](#).
2. If removed, [Install the full length expansion risers](#).
i **NOTE:** Before installing the full length expansion card risers, install the GPU air shroud.
3. [Install the air shroud](#) or [install the GPU air shroud](#).
4. [Install the cooling fan cage assembly](#).
5. [Install the air shroud top cover](#).
6. [Install the support bar](#).
7. Follow the procedure listed in [After working inside your system](#).
8. To verify that the memory module has been installed properly, press F2 during reboot and go to **System Setup Main Menu > System BIOS > Memory Settings**. In the **Memory Settings** screen, the System Memory Size must reflect the updated capacity of the installed memory.
9. If the System Memory Size is incorrect, one or more of the memory modules may not be installed properly. Shut down the system and ensure that the memory modules are firmly seated in the correct sockets.
10. Run the system memory test in system diagnostics.

Expansion cards and expansion card risers

i **NOTE:** When an expansion card is not supported or missing, the iDRAC and Lifecycle Controller logs an event. This does not prevent your system from booting. However, if a F1/F2 pause occurs with an error message, see *Troubleshooting expansion cards* section in the *PowerEdge Servers Troubleshooting Guide* at www.dell.com/poweredgemanuals.

Expansion card installation guidelines

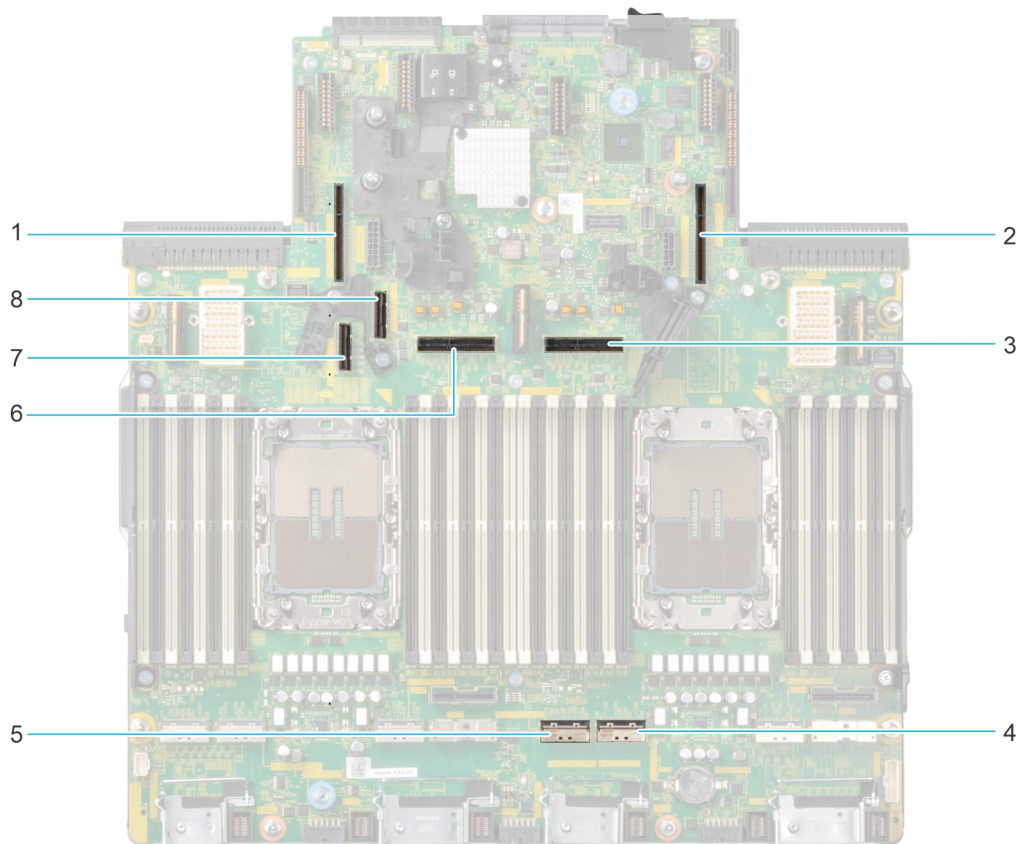

Figure 95. Expansion card riser slot connectors on system board

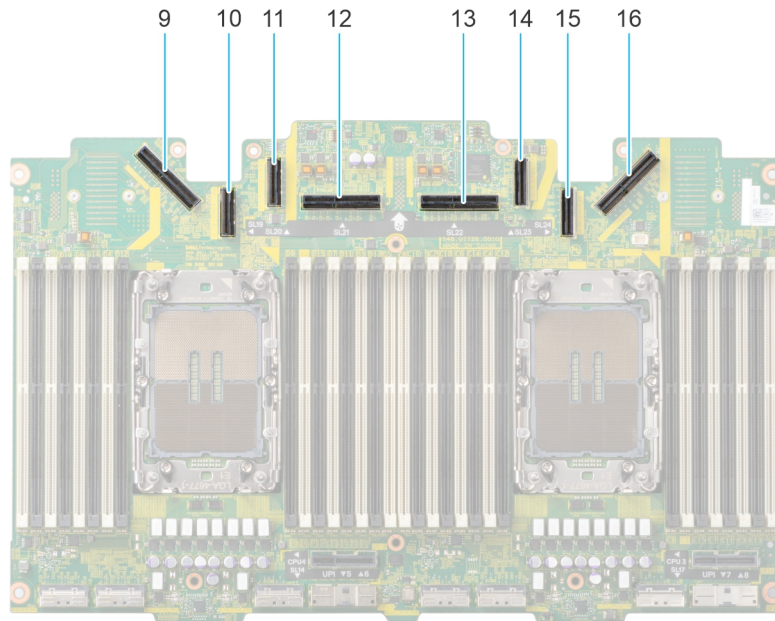

Figure 96. Expansion card riser slot connectors on processor expansion module (PEM) board

- | | |
|---|---|
| 1. Riser 4A/4B/4C slot | 2. Riser 1A/1B/1C slot |
| 3. Riser 2 cable slot / Riser 3B cable slot | 4. Riser 1B cable slot |
| i NOTE: If present, riser 2 uses the connector, otherwise riser 3B uses it. | |
| 5. Riser 1B cable slot | 6. Riser 2 cable slot / Riser 3B cable slot |
| | i NOTE: If present, riser 2 uses the connector, otherwise riser 3B uses it. |
| 7. Riser 4B cable slot | 8. Riser 4B cable slot |
| 9. Riser 4A/4B/4C cable slot | 10. Riser 3B cable slot |
| 11. Riser 3B cable slot | 12. Riser 3A/3B cable slot |
| | i NOTE: If riser 2 is present, riser 3A/3B uses this connector. |
| 13. Riser 3A/3B cable slot | 14. Riser 3B cable slot |
| i NOTE: If riser 2 is present, riser 3A/3B uses this connector. | |
| 15. Riser 3B cable slot | 16. Riser 1A/1B/1C cable slot |

i **NOTE:** A riser can be connected to the riser slot or riser cable slot or both depending on the type of riser used.

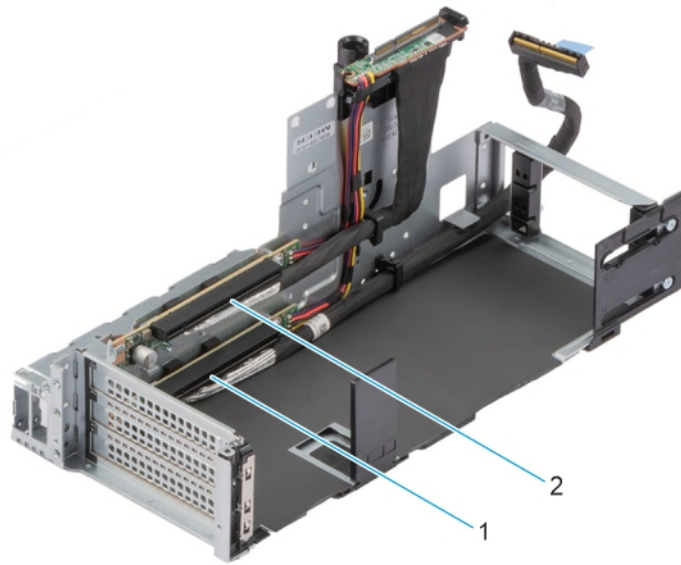

Figure 97. Riser 1A (FL)

- 1. Slot 1
- 2. Slot 3

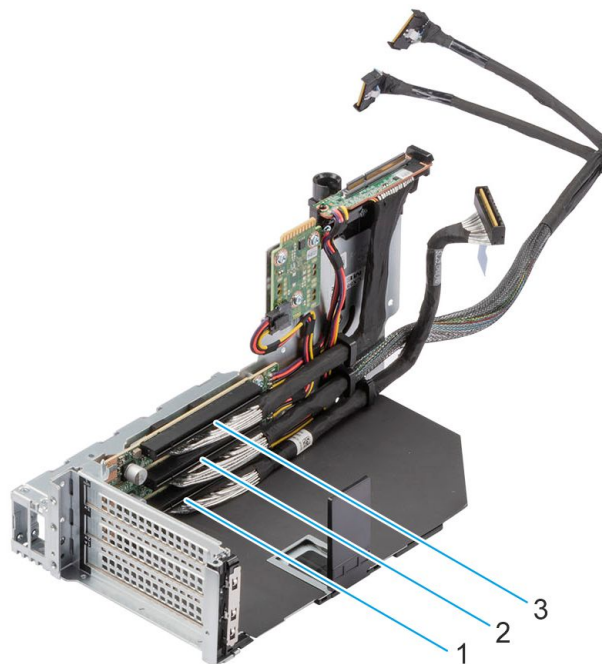

Figure 98. Riser 1B

- 1. Slot 1
- 2. Slot 2
- 3. Slot 3

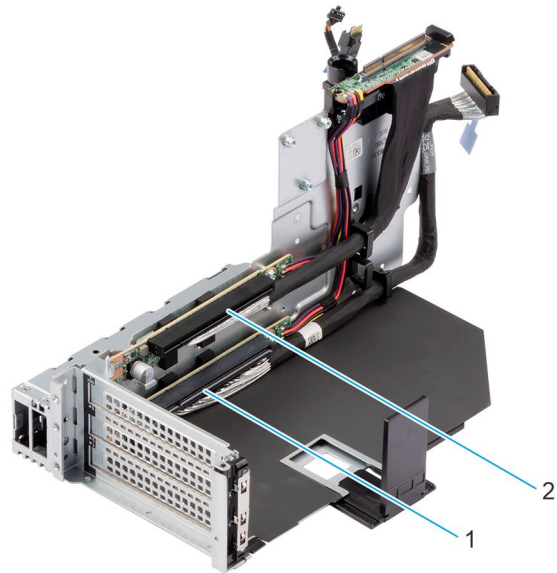

Figure 99. Riser 1C

- 1. Slot 1
- 2. Slot 3

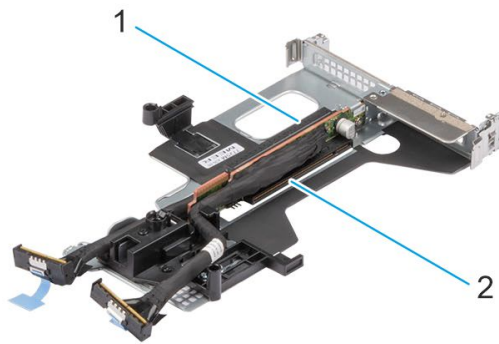

Figure 100. Riser 2

- 1. Slot 4
- 2. Slot 9

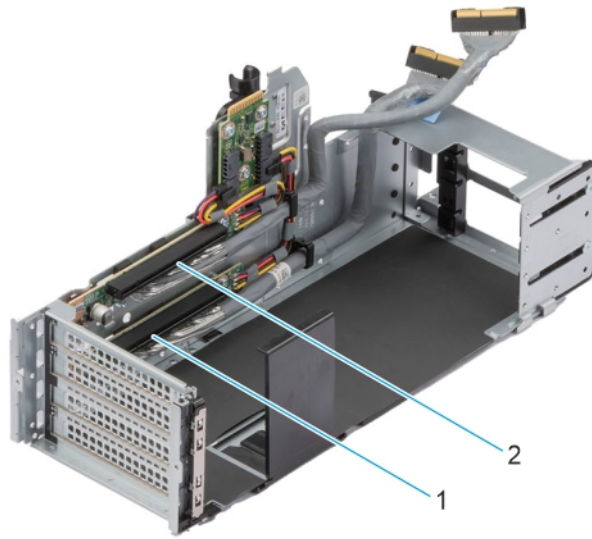

Figure 101. Riser 3A (FL)

- 1. Slot 6
- 2. Slot 8

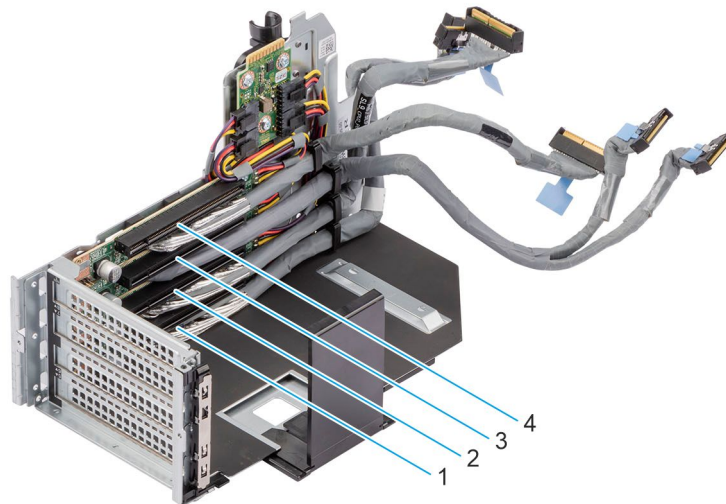

Figure 102. Riser 3B

- 1. Slot 5
- 2. Slot 6
- 3. Slot 7
- 4. Slot 8

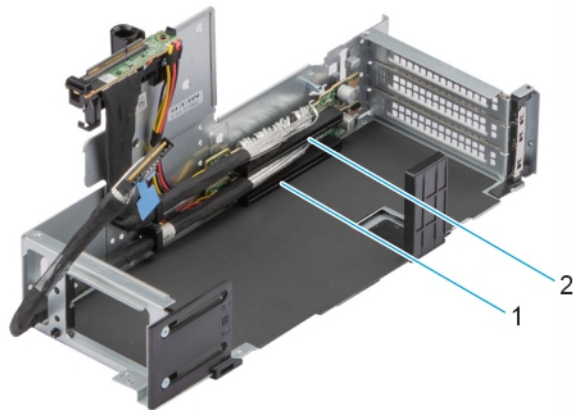

Figure 103. Riser 4A (FL)

1. Slot 10
2. Slot 11

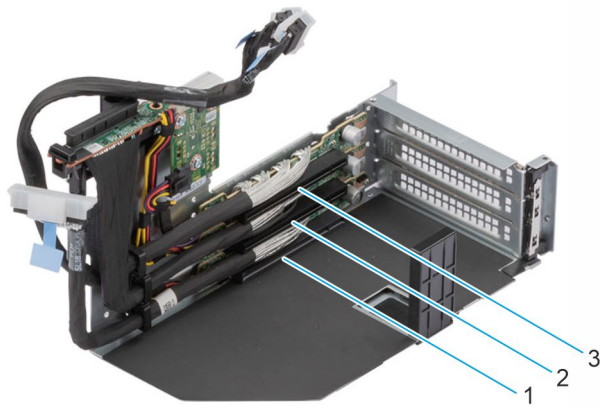

Figure 104. Riser 4B

1. Slot 10
2. Slot 11
3. Slot 12

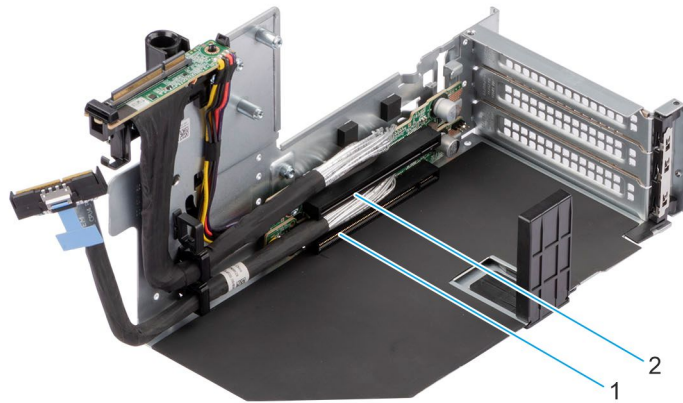

Figure 105. Riser 4C

1. Slot 10
2. Slot 11

NOTE: The expansion-card slots are not hot-swappable.

The following table provides guidelines for installing expansion cards to ensure proper cooling and mechanical fit. The expansion cards with the highest priority should be installed first using the slot priority indicated. All the other expansion cards should be installed in the card priority and slot priority order.

Table 84. Expansion card riser configurations

Configurations	Expansion card risers	PCIe Slots	Form factor	Controlling processor	Slot's electrical bandwidth/ physical connector
Config0-1. 4 x16 FH	R1C	1	Full Height	Processor 3	PCIe Gen5 x16 (x16 connector)
		3	Full Height	Processor 1	PCIe Gen5 x16 (x16 connector)
	R4C	10	Full Height	Processor 4	PCIe Gen5 x16 (x16 connector)
		11	Full Height	Processor 2	PCIe Gen5 x16 (x16 connector)
Config0-2. 2 x16 FH	R1C	3	Full Height	Processor 1	PCIe Gen5 x16 (x16 connector)
	R4C	11	Full Height	Processor 2	PCIe Gen5 x16 (x16 connector)
Config1. 8 x16 FH	R1C	1	Full Height	Processor 3	PCIe Gen5 x16 (x16 connector)
		3	Full Height	Processor 1	PCIe Gen5 x16 (x16 connector)
	R3B	5	Full Height	Processor 4	PCIe Gen5 x16 (x16 connector)
		6	Full Height	Processor 2	PCIe Gen5 x16 (x16 connector)

Table 84. Expansion card riser configurations (continued)

Configurations	Expansion card risers	PCIe Slots	Form factor	Controlling processor	Slot's electrical bandwidth/ physical connector
		7	Full Height	Processor 3	PCIe Gen5 x16 (x16 connector)
		8	Full Height	Processor 1	PCIe Gen5 x16 (x16 connector)
	R4C	10	Full Height	Processor 4	PCIe Gen5 x16 (x16 connector)
		11	Full Height	Processor 2	PCIe Gen5 x16 (x16 connector)
Config2. 2 x16 LP + 10 x16 FH	R1B	1	Full Height	Processor 3	PCIe Gen5 x16 (x16 connector)
		2	Full Height	Processor 1	PCIe Gen5 x16 (x16 connector)
		3	Full Height	Processor 1	PCIe Gen5 x16 (x16 connector)
	R2	4	Low Profile	Processor 2	PCIe Gen5 x16 (x16 connector)
		9	Low Profile	Processor 1	PCIe Gen5 x16 (x16 connector)
	R3B	5	Full Height	Processor 4	PCIe Gen5 x16 (x16 connector)
		6	Full Height	Processor 4	PCIe Gen5 x16 (x16 connector)
		7	Full Height	Processor 3	PCIe Gen5 x16 (x16 connector)
		8	Full Height	Processor 3	PCIe Gen5 x16 (x16 connector)
	R4B	10	Full Height	Processor 4	PCIe Gen5 x16 (x16 connector)
		11	Full Height	Processor 2	PCIe Gen5 x16 (x16 connector)
		12	Full Height	Processor 2	PCIe Gen5 x16 (x16 connector)
Config3. 2 x16 LP + 2 x16 FH + 4 x16 DW	R1A	1	Full Height	Processor 3	PCIe Gen5 x16 (x16 connector)
		3	Full Height (DW)	Processor 1	PCIe Gen5 x16 (x16 connector)
	R2	4	Low Profile	Processor 2	PCIe Gen5 x16 (x16 connector)
		9	Low Profile	Processor 1	PCIe Gen5 x16 (x16 connector)
	R3A	6	Full Height (DW)	Processor 4	PCIe Gen5 x16 (x16 connector)
		8	Full Height (DW)	Processor 3	PCIe Gen5 x16 (x16 connector)

Table 84. Expansion card riser configurations (continued)

Configurations	Expansion card risers	PCIe Slots	Form factor	Controlling processor	Slot's electrical bandwidth/ physical connector
	R4A	10	Full Height	Processor 4	PCIe Gen5 x16 (x16 connector)
		11	Full Height (DW)	Processor 2	PCIe Gen5 x16 (x16 connector)

Table 85. Configuration 0-1: R1C+R4C

Card type	Slot priority	Maximum number of cards
Inventec (Serial)	INT	1
Compal (Serial)	INT	1
Amphenol Bizlink Luxshare (VGA)	INT	1
Foxconn (Front PERC) H755	INT	2
Inventec (LOM Card) 1GX2, 16G	INT	1
Broadcom (OCP: 100 Gb) 2P, Q56	INT	1
Broadcom (OCP: 10 Gb) 4P, BT	INT	1
Intel (OCP: 1 Gb) 4P, V2	INT	1
Intel (OCP: 25 Gb) 4P, V2	INT	1
Intel (OCP: 25 Gb) 2P, V2	INT	1
Foxconn (BOSS-N1, Monolithic)	INT	1
Dell (LOM Card) 1GX2, V2, 16G	INT	1
Foxconn (Front PERC) H965i	INT	2
Foxconn (Front PERC) H755	INT	2
Foxconn (Front PERC) H355	INT	2
Mellanox (NIC: NDR400) FH, 1P,OSF	1, 3, 10, 11	2
Mellanox (NIC: NDR200) FH, 1P,OSF	1, 3, 10, 11	4
Marvell (HBA: FC32) FH, 1P, S28, F1	3, 10, 11	3
Broadcom (HBA: FC32) FH, 1P,SPDM	3, 10, 11	3
Marvell (HBA: FC32) FH, 2P, S28, F1	3, 10, 11	3
Broadcom (HBA: FC32) FH, 2P,SPDM	3, 10, 11	3
Broadcom (HBA: FC64) FH, 2P,SPDM	3, 10, 11	3
Broadcom (NIC: 10 Gb) DP,57416,FH	1, 3, 11	3
Broadcom (NIC: 100 Gb) FH, 2P, Q56	1, 3, 10, 11	4
Intel (NIC: 100 Gb) FH, 2P, Q28	1, 3, 10, 11	4
Mellanox (NIC: 100 Gb) FH, 2P, Q56	1, 3, 10, 11	4
Intel (NIC: 25 Gb) FH, 2P, S28	1, 3, 10, 11	4
Intel (NIC: 25 Gb) FH, 4P, S28	1, 3, 10, 11	4
Mellanox (NIC: 25 Gb) FH, 2P, S28	1, 3, 10, 11	4
Broadcom (NIC: 25 Gb) FH, 4P, S28	1, 3, 10, 11	4

Table 85. Configuration 0-1: R1C+R4C (continued)

Card type	Slot priority	Maximum number of cards
Broadcom (NIC: 10 Gb) FH, 4P,BT	1, 3, 10, 11	4
Intel (NIC: 10 Gb) FH, 4P,BT	1, 3, 10, 11	4
Intel (NIC: 10 Gb) FH, 2P,BT	1, 3, 10, 11	4
Mellanox (NIC: HDR100 VPI) CX6,SP,F,ML	1, 3, 10, 11	4
Intel (NIC: 1 GB) QP, F1	1, 3, 10, 11	4
Broadcom (NIC: 1 GB) FH, 4P, F1	1, 3, 10, 11	4
Broadcom (NIC: 25 GB) FH, 2P,SFP,F1	1, 3, 10, 11	4
Foxconn (Front PERC) HBA355i, V2	INT	2
Broadcom (OCP: 25 Gb) 4P, V3	INT	1
Broadcom (OCP: 25 Gb) 2P, V3	INT	1
Broadcom (OCP: 25 Gb) 2P,V2	INT	1
Broadcom (OCP: 1 Gb) 4P,BT,V2	INT	1

Table 86. Configuration 0-2: R1C+R4C

Card type	Slot priority	Maximum number of cards
Inventec (Serial)	INT	1
Compal (Serial)	INT	1
Amphenol Bizlink Luxshare (VGA)	INT	1
Foxconn (Front PERC) H755	INT	2
Inventec (LOM Card) 1GX2, 16G	INT	1
Broadcom (OCP: 100 Gb) 2P, Q56	INT	1
Broadcom (OCP: 10 Gb) 4P, BT	INT	1
Intel (OCP: 1 Gb) 4P, V2	INT	1
Intel (OCP: 25 Gb) 4P, V2	INT	1
Intel (OCP: 25 Gb) 2P, V2	INT	1
Foxconn (BOSS-N1, Monolithic)	INT	1
Dell (LOM Card) 1GX2, V2, 16G	INT	1
Foxconn (Front PERC) H965i	INT	2
Foxconn (Front PERC) H755	INT	2
Foxconn (Front PERC) H355	INT	2
Mellanox (NIC: NDR400) FH, 1P,OSF	3, 11	2
Mellanox (NIC: NDR200) FH, 1P,OSF	3, 11	2
Marvell (HBA: FC32) FH, 1P, S28, F1	3, 11	2
Broadcom (HBA: FC32) FH, 1P,SPDM	3, 11	2
Marvell (HBA: FC32) FH, 2P, S28, F1	3, 11	2
Broadcom (HBA: FC32) FH, 2P,SPDM	3, 11	2
Broadcom (HBA: FC64) FH, 2P,SPDM	3, 11	2

Table 86. Configuration 0-2: R1C+R4C (continued)

Card type	Slot priority	Maximum number of cards
Broadcom (NIC: 10 Gb) DP,57416,FH	3, 11	2
Broadcom (NIC: 100 Gb) FH, 2P, Q56	3, 11	2
Intel (NIC: 100 Gb) FH, 2P, Q28	3, 11	2
Mellanox (NIC: 100 Gb) FH, 2P, Q56	3, 11	2
Intel (NIC: 25 Gb) FH, 2P, S28	3, 11	2
Intel (NIC: 25 Gb) FH, 4P, S28	3, 11	2
Mellanox (NIC: 25 Gb) FH, 2P, S28	3, 11	2
Broadcom (NIC: 25 Gb) FH, 4P, S28	3, 11	2
Broadcom (NIC: 10 Gb) FH, 4P,BT	3, 11	2
Intel (NIC: 10 Gb) FH, 4P,BT	3, 11	2
Intel (NIC: 10 Gb) FH, 2P,BT	3, 11	2
Mellanox (NIC: HDR100 VPI) CX6,SP,F,ML	3, 11	2
Intel (NIC: 1 GB) QP, F1	3, 11	2
Broadcom (NIC: 1 GB) FH, 4P, F1	3, 11	2
Broadcom (NIC: 25 GB) FH, 2P,SFP,F1	3, 11	2
Foxconn (Front PERC) HBA355i, V2	INT	2
Broadcom (OCP: 25 Gb) 4P, V3	INT	1
Broadcom (OCP: 25 Gb) 2P, V3	INT	1
Broadcom (OCP: 25 Gb) 2P, V2	INT	1
Broadcom (OCP: 1 Gb) 4P,BT,V2	INT	1

Table 87. Configuration 1: R1C+R3B+R4C

Card type	Slot priority	Maximum number of cards
Inventec (Serial)	INT	1
Compal (Serial)	INT	1
Amphenol Bizlink Luxshare (VGA)	INT	1
Foxconn (Front PERC) H755	INT	2
Inventec (LOM Card) 1GX2, 16G	INT	1
Broadcom (OCP: 100 Gb) 2P, Q56	INT	1
Broadcom (OCP: 10 Gb) 4P, BT	INT	1
Intel (OCP: 1 Gb) 4P, V2	INT	1
Intel (OCP: 25 Gb) 4P, V2	INT	1
Intel (OCP: 25 Gb) 2P, V2	INT	1
Foxconn (BOSS-N1, Monolithic)	INT	1
Dell (LOM Card) 1GX2, V2, 16G	INT	1
Foxconn (Front PERC) H965i	INT	2
Foxconn (Front PERC) H755	INT	2

Table 87. Configuration 1: R1C+R3B+R4C (continued)

Card type	Slot priority	Maximum number of cards
Foxconn (Front PERC) H355	INT	2
Mellanox (NIC: NDR400) FH, 1P,OSF	1, 3, 5, 6, 7, 8, 10, 11	8
Mellanox (NIC: NDR200) FH, 1P,OSF	1, 3, 5, 6, 7, 8, 10, 11	8
Marvell (HBA: FC32) FH, 1P, S28, F1	3, 6, 7, 10, 8, 11	6
Broadcom (HBA: FC32) FH, 1P,SPDM	3, 6, 7, 10, 8, 11	6
Marvell (HBA: FC32) FH, 2P, S28, F1	3, 6, 7, 10, 8, 11	6
Broadcom (HBA: FC32) FH, 2P,SPDM	3, 6, 7, 10, 8, 11	6
Broadcom (HBA: FC64) FH, 2P,SPDM	3, 6, 7, 10, 8, 11	6
Broadcom (NIC: 10 Gb) DP,57416,FH	1, 3, 5, 6, 7, 8, 11	7
Broadcom (NIC: 100 Gb) FH, 2P, Q56	1, 3, 5, 6, 7, 8, 10, 11	8
Intel (NIC: 100 Gb) FH, 2P, Q28	1, 3, 5, 6, 7, 8, 10, 11	8
Mellanox (NIC: 100 Gb) FH, 2P, Q56	1, 3, 5, 6, 7, 8, 10, 11	8
Intel (NIC: 25 Gb) FH, 2P, S28	1, 3, 5, 6, 7, 8, 10, 11	8
Intel (NIC: 25 Gb) FH, 4P, S28	1, 3, 5, 6, 7, 8, 10, 11	8
Mellanox (NIC: 25 Gb) FH, 2P, S28	1, 3, 5, 6, 7, 8, 10, 11	8
Broadcom (NIC: 25 Gb) FH, 4P, S28	1, 3, 5, 6, 7, 8, 10, 11	8
Broadcom (NIC: 10 Gb) FH, 4P,BT	1, 3, 5, 6, 7, 8, 10, 11	8
Intel (NIC: 10 Gb) FH, 4P,BT	1, 3, 5, 6, 7, 8, 10, 11	8
Intel (NIC: 10 Gb) FH, 2P,BT	1, 3, 5, 6, 7, 8, 10, 11	8
Mellanox (NIC: HDR100 VPI) CX6,SP,F,ML	1, 3, 5, 6, 7, 8, 10, 11	8
Intel (NIC: 1 GB) QP, F1	1, 3, 5, 6, 7, 8, 10, 11	8
Broadcom (NIC: 1 GB) FH, 4P, F1	1, 3, 5, 6, 7, 8, 10, 11	8
Broadcom (NIC: 25 GB) FH, 2P,SFP,F1	1, 3, 5, 6, 7, 8, 10, 11	8
Foxconn (Front PERC) HBA355i, V2	INT	2
Broadcom (OCP: 25 Gb) 4P, V3	INT	1
Broadcom (OCP: 25 Gb) 2P, V3	INT	1
Broadcom (OCP: 25 Gb) 2P, V2	INT	1
Broadcom (OCP: 1 Gb) 4P,BT,V2	INT	1

Table 88. Configuration 2: R1B+R2+R3B+R4B

Card type	Slot priority	Maximum number of cards
Inventec (Serial)	INT	1
Compal (Serial)	INT	1
Amphenol Bizlink Luxshare (VGA)	INT	1
Foxconn (Front PERC) H755	INT	2
Inventec (LOM Card) 1GX2, 16G	INT	1
Broadcom (OCP: 100 Gb) 2P, Q56	INT	1

Table 88. Configuration 2: R1B+R2+R3B+R4B (continued)

Card type	Slot priority	Maximum number of cards
Broadcom (OCP: 10 Gb) 4P, BT	INT	1
Intel (OCP: 1 Gb) 4P, V2	INT	1
Intel (OCP: 25 Gb) 4P, V2	INT	1
Intel (OCP: 25 Gb) 2P, V2	INT	1
Foxconn (BOSS-N1, Monolithic)	INT	1
Dell (LOM Card) 1GX2, V2, 16G	INT	1
Foxconn (Front PERC) H965i	INT	2
Foxconn (Front PERC) H755	INT	2
Foxconn (Front PERC) H355	INT	2
Foxconn (Adapter PERC) HBA355E Kit	4, 9	2
Foxconn (Adapter PERC) H965e	4, 9	1
Mellanox (NIC: NDR400) LP, 1P,OSF	4, 9	2
Mellanox (NIC: NDR200) LP, 1P,OSF	4, 9	2
Mellanox (NIC: NDR400) FH, 1P,OSF	1, 3, 5, 11, 6, 7, 2, 12, 8, 10	10
Mellanox (NIC: NDR200) FH, 1P,OSF	1, 3, 5, 11, 6, 7, 2, 12, 8, 10	10
Marvell (HBA: FC32) FH, 1P, S28, F1	3, 6, 7, 11, 10, 2, 8	7
Broadcom (HBA: FC32) FH, 1P,SPDM	3, 6, 7, 11, 10, 2, 8	7
Marvell (HBA: FC32) FH, 2P, S28, F1	3, 6, 7, 11, 10, 2, 8	7
Broadcom (HBA: FC32) FH, 2P,SPDM	3, 6, 7, 11, 10, 2, 8	7
Broadcom (HBA: FC64) FH, 2P,SPDM	3, 6, 7, 11, 10, 2, 8	7
Broadcom (NIC: 10 Gb) DP,57416,FH	1, 3, 5, 11, 6, 7, 2, 12, 8	9
Broadcom (NIC: 100 Gb) FH, 2P, Q56	1, 3, 5, 11, 6, 7, 2, 12, 8, 10	10
Intel (NIC: 100 Gb) FH, 2P, Q28	1, 3, 5, 11, 6, 7, 2, 12, 8, 10	10
Mellanox (NIC: 100 Gb) FH, 2P, Q56	1, 3, 5, 11, 6, 7, 2, 12, 8, 10	10
Intel (NIC: 25 Gb) FH, 2P, S28	1, 3, 5, 11, 6, 7, 2, 12, 8, 10	10
Intel (NIC: 25 Gb) FH, 4P, S28	1, 3, 5, 11, 6, 7, 2, 12, 8, 10	10
Mellanox (NIC: 25 Gb) FH, 2P, S28	1, 3, 5, 11, 6, 7, 2, 12, 8, 10	10
Broadcom (NIC: 25 Gb) FH, 4P, S28	1, 3, 5, 11, 6, 7, 2, 12, 8, 10	10
Broadcom (NIC: 10 Gb) FH, 4P,BT	1, 3, 5, 11, 6, 7, 2, 12, 8, 10	10
Intel (NIC: 10 Gb) FH, 4P,BT	1, 3, 5, 11, 6, 7, 2, 12, 8, 10	10
Intel (NIC: 10 Gb) FH, 2P,BT	1, 3, 5, 11, 6, 7, 2, 12, 8, 10	10
Mellanox (NIC: HDR100 VPI) CX6,SP,F,ML	1, 3, 5, 11, 6, 7, 2, 12, 8, 10	10
Intel (NIC: 1 GB) QP, F1	1, 3, 5, 11, 6, 7, 2, 12, 8, 10	10
Broadcom (NIC: 1 GB) FH, 4P, F1	1, 3, 5, 11, 6, 7, 2, 12, 8, 10	10
Broadcom (NIC: 25 GB) FH, 2P,SFP,F1	1, 3, 5, 11, 6, 7, 2, 12, 8, 10	10
Broadcom (NIC: 100 Gb) LP, 2P, Q56	4, 9	2
Intel (NIC: 100 Gb) LP, 2P, Q28	4, 9	2

Table 88. Configuration 2: R1B+R2+R3B+R4B (continued)

Card type	Slot priority	Maximum number of cards
Mellanox (NIC: 100 Gb) LP, 2P, Q56	4,	1
Intel (NIC: 25 Gb) LP, 2P, S28	4, 9	2
Mellanox (NIC: 25 Gb) LP, 2P, S28	4	10
Broadcom (NIC: 10 Gb) LP, 4P,BT	4, 9	2
Broadcom (NIC: 10 Gb) DP,57416,LP	4, 9	2
Intel (NIC: 10 Gb) LP, 4P,BT	4, 9	2
Intel (NIC: 10 Gb) LP, 2P,BT	4, 9	2
Mellanox (NIC: HDR100 VPI) CX6,SP,L,ML	4, 9	2
Intel (NIC: 1 GB) QP,LP,F1	4, 9	2
Broadcom (NIC: 1 GB) LP, 4P, F1	4, 9	2
Broadcom (NIC: 25 GB) LP,SFP,F1	4, 9	2
Marvell (HBA: FC32) LP, 1P, S28, F1	4, 9	2
Broadcom (HBA: FC32) LP, 1P,SPDM	4, 9	2
Marvell (HBA: FC32) LP, 2P, S28, F1	4, 9	2
Broadcom (HBA: FC32) LP, 2P,SPDM	4, 9	2
Broadcom (HBA: FC64) LP, 2P,SPDM	4, 9	2
Foxconn (Front PERC) HBA355i, V2	INT	2
Broadcom (OCP: 25 Gb) 4P, V3	INT	1
Broadcom (OCP: 25 Gb) 2P, V3	INT	1
Broadcom (OCP: 25 Gb) 2P, V2	INT	1
Broadcom (OCP: 1 Gb) 4P,BT,V2	INT	1

Table 89. Configuration 3: R1A+R2+R3A+R4A

Card type	Slot priority	Maximum number of cards
Inventec (Serial)	INT	1
Compal (Serial)	INT	1
Amphenol Bizlink Luxshare (VGA)	INT	1
Foxconn (Front PERC) H755	INT	2
Inventec (LOM Card) 1GX2, 16G	INT	1
Broadcom (OCP: 100 Gb) 2P, Q56	INT	1
Broadcom (OCP: 10 Gb) 4P, BT	INT	1
Intel (OCP: 1 Gb) 4P, V2	INT	1
Intel (OCP: 25 Gb) 4P, V2	INT	1
Intel (OCP: 25 Gb) 2P, V2	INT	1
Foxconn (BOSS-N1, Monolithic)	INT	1
Dell (LOM Card) 1GX2, V2, 16G	INT	1
Foxconn (Front PERC) H965i	INT	2

Table 89. Configuration 3: R1A+R2+R3A+R4A (continued)



Card type	Slot priority	Maximum number of cards
Foxconn (Front PERC) H755	INT	2
Foxconn (Front PERC) H355	INT	2
Foxconn (Adapter PERC) HBA355E Kit	4, 9	2
Foxconn (Adapter PERC) H965e	4, 9	1
NVIDIA (GPU) A800,80 Gb,300 W	3, 6, 8, 11	4
NVIDIA (GPU) A100,80 Gb,V2	3, 6, 8, 11	4
NVIDIA (GPU) A16,64 Gb,V2	3, 6, 8, 11	4
Mellanox (NIC: NDR400) LP, 1P,OSF	4, 9	2
Mellanox (NIC: NDR200) LP, 1P,OSF	4, 9	2
Mellanox (NIC: NDR400) FH, 1P,OSF	3, 6, 8, 11, 1, 10	6
Mellanox (NIC: NDR200) FH, 1P,OSF	3, 6, 8, 11, 1, 10	6
Marvell (HBA: FC32) FH, 1P, S28, F1	3, 6, 8, 11, 10	5
Broadcom (HBA: FC32) FH, 1P,SPDM	3, 6, 8, 11, 10	5
Marvell (HBA: FC32) FH, 2P, S28, F1	3, 6, 8, 11, 10	5
Broadcom (HBA: FC32) FH, 2P,SPDM	3, 6, 8, 11, 10	5
Broadcom (HBA: FC64) FH, 2P,SPDM	3, 6, 8, 11, 10	5
Broadcom (NIC: 10 Gb) DP,57416,FH	3, 6, 8, 11, 1	5
Broadcom (NIC: 100 Gb) FH, 2P, Q56	3, 6, 8, 11, 1, 10	6
Intel (NIC: 100 Gb) FH, 2P, Q28	3, 6, 8, 11, 1, 10	6
Mellanox (NIC: 100 Gb) FH, 2P, Q56	3, 6, 8, 11, 1, 10	6
Intel (NIC: 25 Gb) FH, 2P, S28	3, 6, 8, 11, 1, 10	6
Intel (NIC: 25 Gb) FH, 4P, S28	3, 6, 8, 11, 1, 10	6
Mellanox (NIC: 25 Gb) FH, 2P, S28	3, 6, 8, 11, 1, 10	6
Broadcom (NIC: 25 Gb) FH, 4P, S28	3, 6, 8, 11, 1, 10	6
Broadcom (NIC: 10 Gb) FH, 4P,BT	3, 6, 8, 11, 1, 10	6
Intel (NIC: 10 Gb) FH, 4P,BT	3, 6, 8, 11, 1, 10	6
Intel (NIC: 10 Gb) FH, 2P,BT	3, 6, 8, 11, 1, 10	6
Mellanox (NIC: HDR100 VPI) CX6,SP,F,ML	3, 6, 8, 11, 1, 10	6
Intel (NIC: 1 GB) QP, F1	3, 6, 8, 11, 1, 10	6
Broadcom (NIC: 1 GB) FH, 4P, F1	3, 6, 8, 11, 1, 10	6
Broadcom (NIC: 25 GB) FH, 2P,SFP,F1	3, 6, 8, 11, 1, 10	6
Broadcom (NIC: 100 Gb) LP, 2P, Q56	4, 9	2
Intel (NIC: 100 Gb) LP, 2P, Q28	4, 9	2
Mellanox (NIC: 100 Gb) LP, 2P, Q56	4	1
Intel (NIC: 25 Gb) LP, 2P, S28	4, 9	2
Mellanox (NIC: 25 Gb) LP, 2P, S28	4	1
Broadcom (NIC: 10 Gb) LP, 4P,BT	4, 9	2

Table 89. Configuration 3: R1A+R2+R3A+R4A (continued)

Card type	Slot priority	Maximum number of cards
Broadcom (NIC: 10 Gb) DP,57416,LP	4, 9	2
Intel (NIC: 10 Gb) LP, 4P,BT	4, 9	2
Intel (NIC: 10 Gb) LP, 2P,BT	4, 9	2
Mellanox (NIC: HDR100 VPI) CX6,SP,L,ML	4, 9	2
Intel (NIC: 1 GB) QP,LP,F1	4, 9	2
Broadcom (NIC: 1 GB) LP, 4P, F1	4, 9	2
Broadcom (NIC: 25 GB) LP,SFP,F1	4, 9	2
Marvell (HBA: FC32) LP, 1P, S28, F1	4, 9	2
Broadcom (HBA: FC32) LP, 1P,SPDM	4, 9	2
Marvell (HBA: FC32) LP, 2P, S28, F1	4, 9	2
Broadcom (HBA: FC32) LP, 2P,SPDM	4, 9	2
Broadcom (HBA: FC64) LP, 2P,SPDM	4, 9	2
Foxconn (Front PERC) HBA355i, V2	INT	2
Broadcom (OCP: 25 Gb) 4P, V3	INT	1
Broadcom (OCP: 25 Gb) 2P, V3	INT	1
Broadcom (OCP: 25 Gb) 2P, V2	INT	1
Broadcom (OCP: 1 Gb) 4P,BT,V2	INT	1

Removing the expansion card risers

Prerequisites

1. Follow the safety guidelines listed in the [Safety instructions](#).
2. Follow the procedure listed in the [Before working inside your system](#).
3. [Remove the support bar](#).
4. [Remove the air shroud top cover](#).
5. [Remove the cooling fan cage assembly](#).
6. [Remove the air shroud](#).
7.  **NOTE:** If BOSS-N1 module is installed, be sure to disconnect the BOSS-N1 power cable and signal cable before removing the riser 1 cage.
8. Disconnect the riser cables from the PEM connectors, observe the cable routing.
 -  **NOTE:** See [cable routing](#) section for more information.
9. If required, disconnect all the UPI cables from the PEM connectors.
10. If required, [remove the PEM](#) to disconnect the riser cable connectors from the system board.
11. [Remove the riser air shroud](#) to access VGA bracket and riser 2.
12. If required, open the cable holder on the system board to access riser cables.
13. For supported riser configurations, see the [Expansion card installation guidelines](#) section.

Steps

1. Loosen the captive screws on the riser and system.
2. Rotate the riser handle to unlock the riser from the system.
3. Holding the riser handle and edges lift the expansion card risers from the connector on the system board.
 -  **NOTE:** The numbers on the image do not depict the exact steps. The numbers are for representation of sequence.

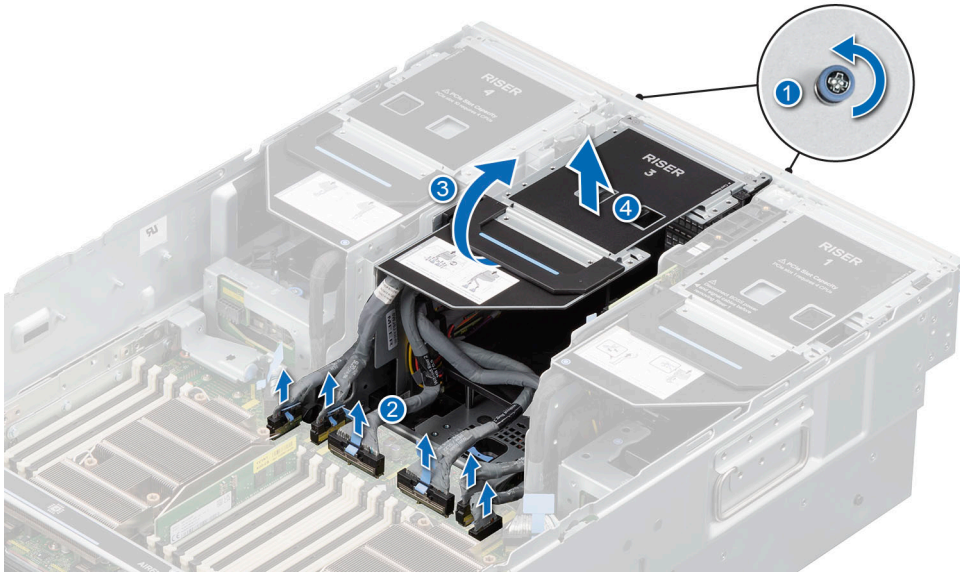

Figure 106. Removing the expansion card riser 3

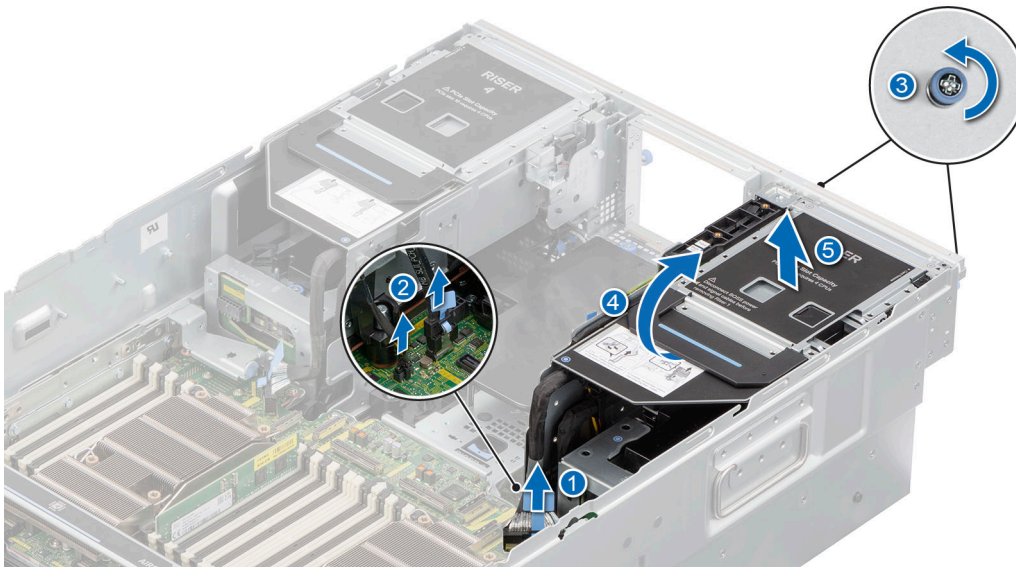

Figure 107. Removing the expansion card riser 1

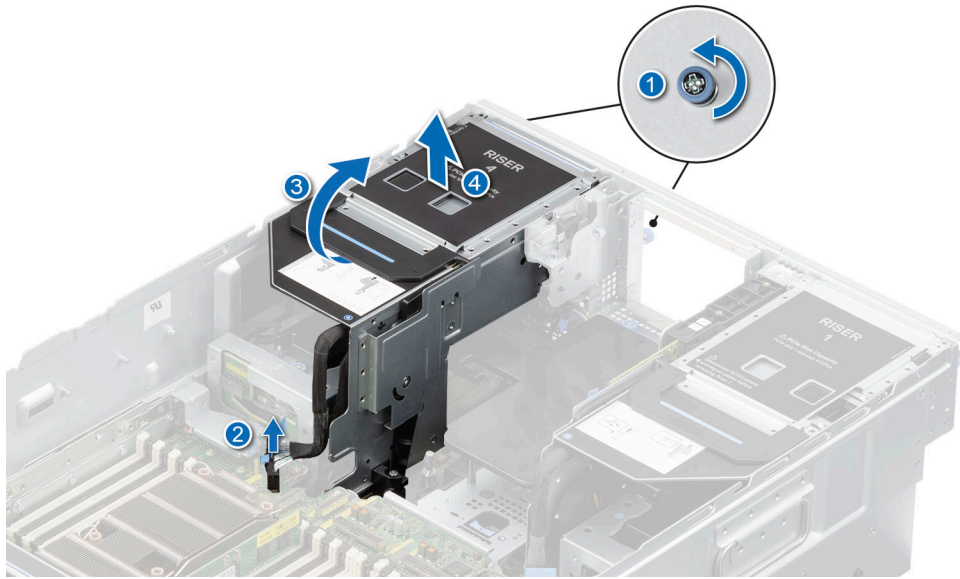

Figure 108. Removing the expansion card riser 4

NOTE: Remove the riser air shroud to access the VGA bracket and the riser 2.

4. Loosen the captive screws and lift the VGA bracket from the system.

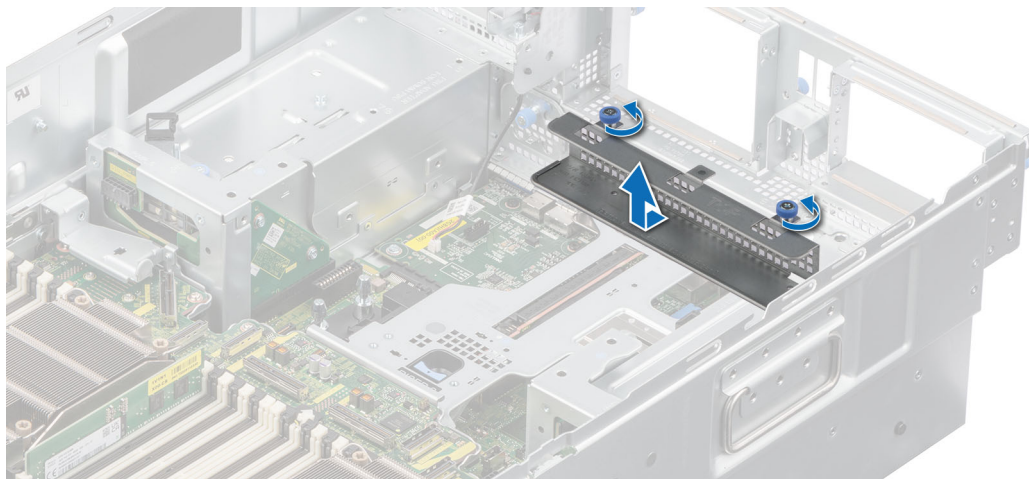

Figure 109. Removing the VGA bracket

5. Press the blue release tab on the riser 2 and holding the riser by the blue touch points, lift the riser 2 from the system board.

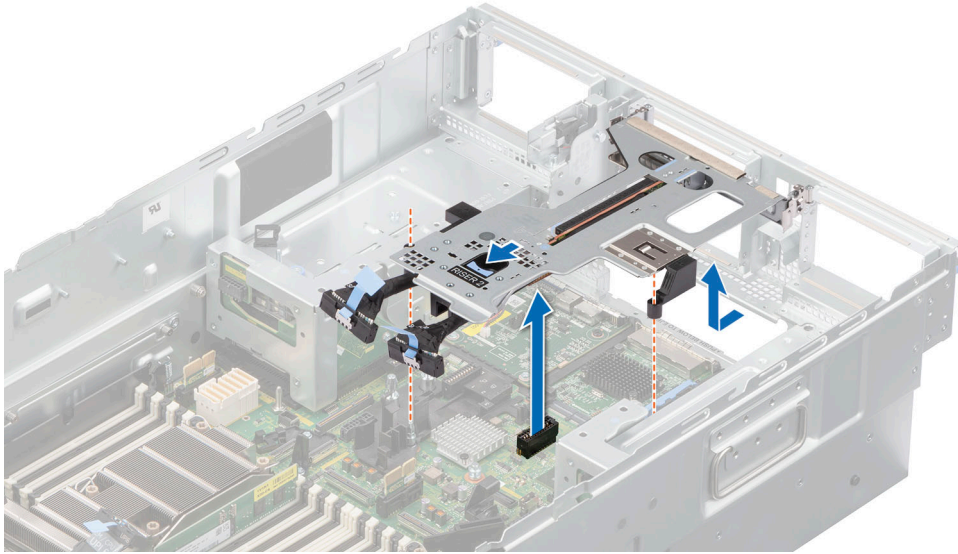

Figure 110. Removing the expansion card riser 2

6. If the risers are not going to be replaced, install riser blanks, and if required tighten the captive screws.

i **NOTE:** You must install a filler bracket over an empty expansion card slot to maintain Federal Communications Commission (FCC) certification of the system. The brackets also keep dust and dirt out of the system and aid in proper cooling and airflow inside the system.

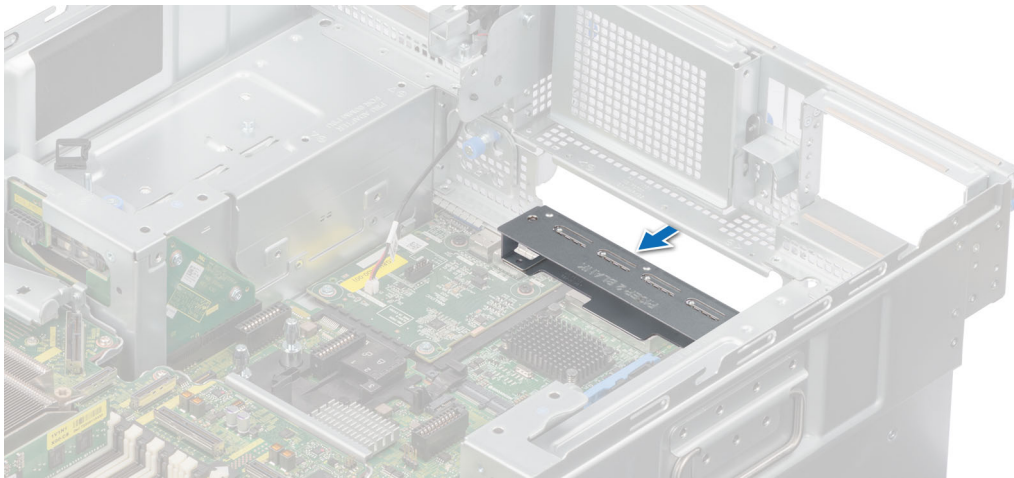

Figure 111. Installing the Riser 2 blank

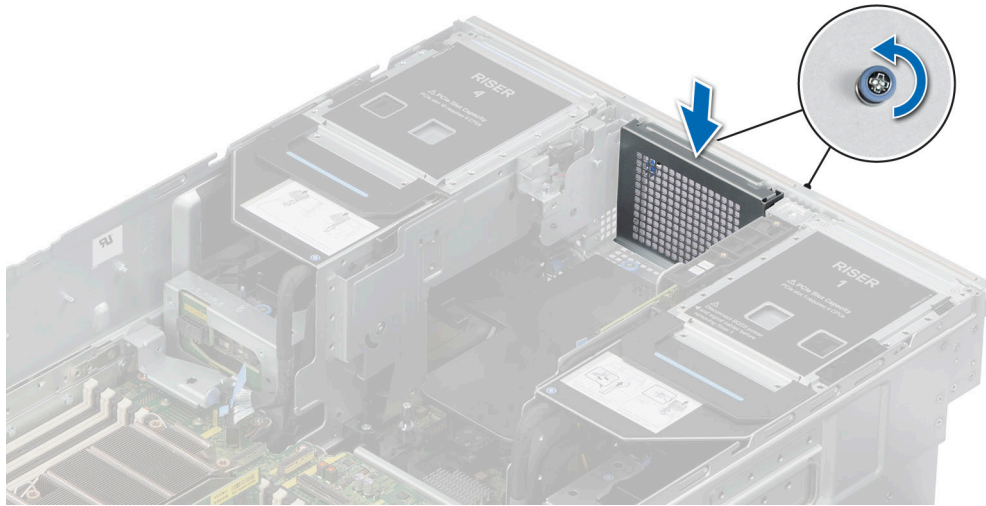

Figure 112. Installing the Riser 3 blank

Next steps

1. [Replace the expansion card riser.](#)

Installing the expansion card risers

Prerequisites

1. Follow the safety guidelines listed in the [Safety instructions](#).
2. Follow the procedure listed in the [Before working inside your system](#).
3. [Remove the support bar.](#)
4. [Remove the air shroud top cover.](#)
5. [Remove the cooling fan cage assembly.](#)
6. [Remove the air shroud.](#)
7. **i** **NOTE:** If BOSS-N1 module is installed, be sure to disconnect the BOSS-N1 power cable and signal cable before removing the riser 1 cage.
8. Disconnect the riser cables from the PEM connectors, observe the cable routing.
 - i** **NOTE:** See [cable routing](#) section for more information.
9. If required, disconnect all the UPI cables from the PEM connectors.
10. If required, [remove the PEM](#) to disconnect the riser cable connectors from the system board.
11. [Remove the riser air shroud](#) to access VGA bracket and riser 2.
12. If required, open the cable holder on the system board to access riser cables.
13. For supported riser configurations, see the [Expansion card installation guidelines](#) section.

⚠ CAUTION: Do not install GPUs, network cards, or other PCIe devices on your system that are not validated and tested by Dell. Damage caused by unauthorized and invalidated hardware installation will null and void the system warranty.

Steps

1. If installed, remove the riser blanks and if required loosen the captive screws.
 - i** **NOTE:** Store the riser blanks for future use. Filler brackets must be installed in empty expansion card slots to maintain Federal Communications Commission (FCC) certification of the system. The brackets also keep dust and dirt out of the system and aid in proper cooling and airflow inside the system.

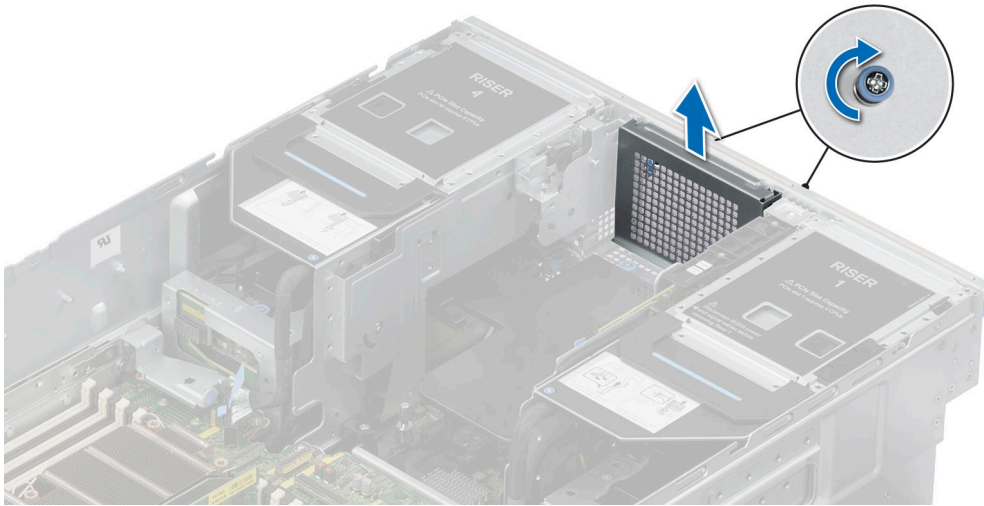

Figure 113. Removing the Riser 3 blank

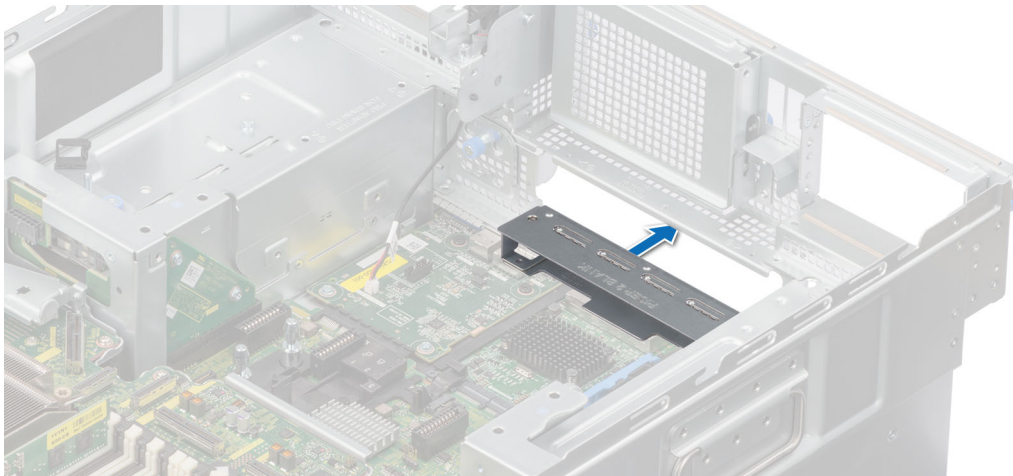

Figure 114. Removing the Riser 2 blank

2. Holding the touch points, align the holes on the expansion card riser 2 with the guides on the system board.
3. Lower the expansion card riser into place and press the touch points until the expansion card riser connector is fully seated on the system board.

(i) NOTE: Connect the riser 2 cables to the system board connectors.

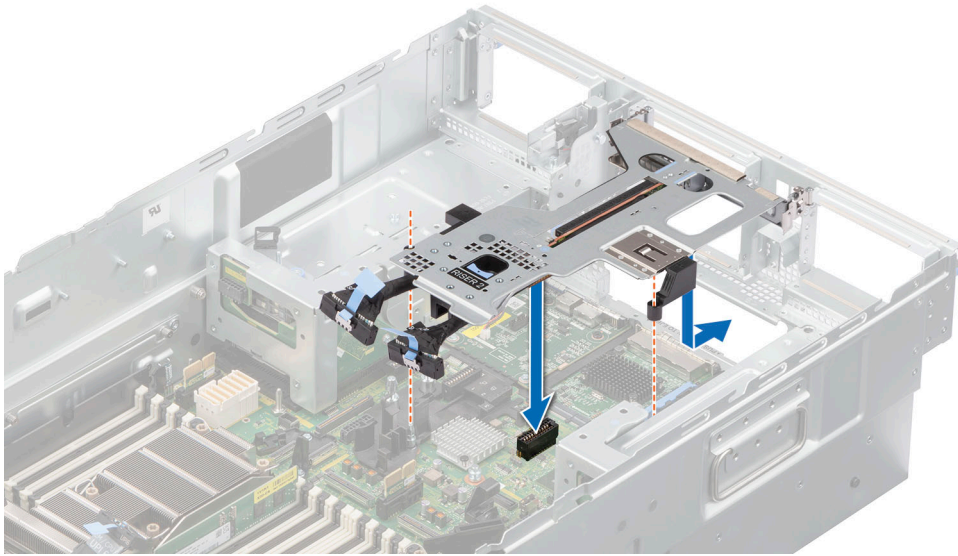

Figure 115. Installing the expansion card riser 2

4. Align the guide pin on the VGA bracket with the slot on the riser 2.
5. Lower the VGA bracket and tighten the captive screws.

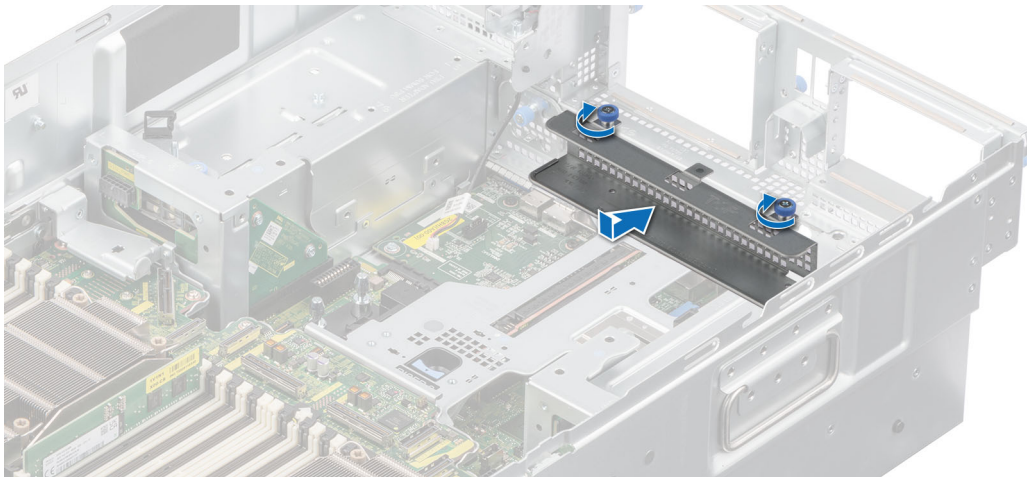

Figure 116. Installing the VGA bracket

i **NOTE:** Install the riser air shroud after installing the riser 2 and the VGA bracket.

6. Holding the riser handle, align the holes on the expansion card riser with the guides on the system.

i **NOTE:** If required, connect the cables from the risers to the system board.

7. Lower the expansion card riser into place and press the touch points until the expansion card riser connector is fully seated on the system board connector.
8. Tighten the captive screws on the risers and system if any.

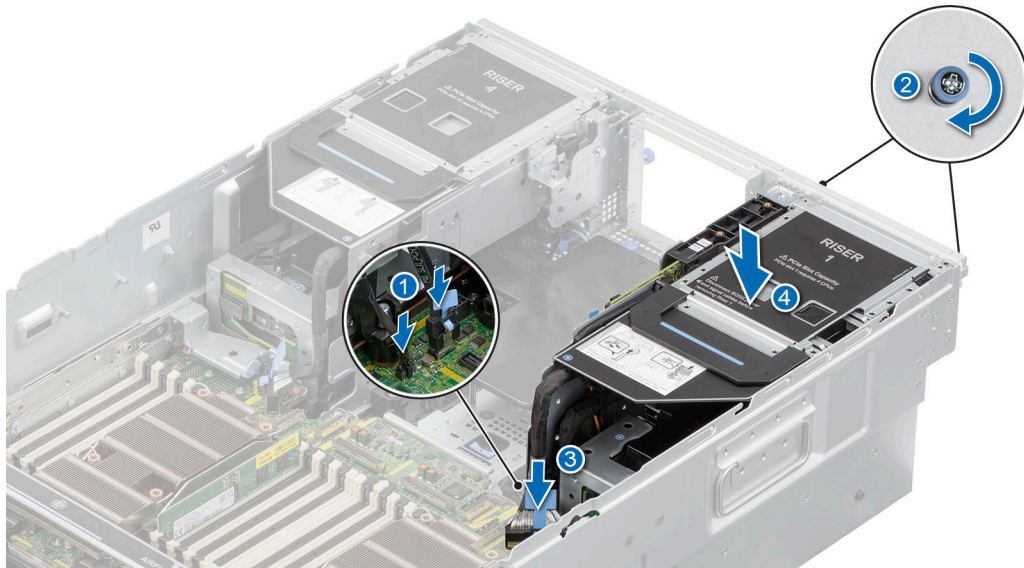

Figure 117. Installing the expansion card riser 1

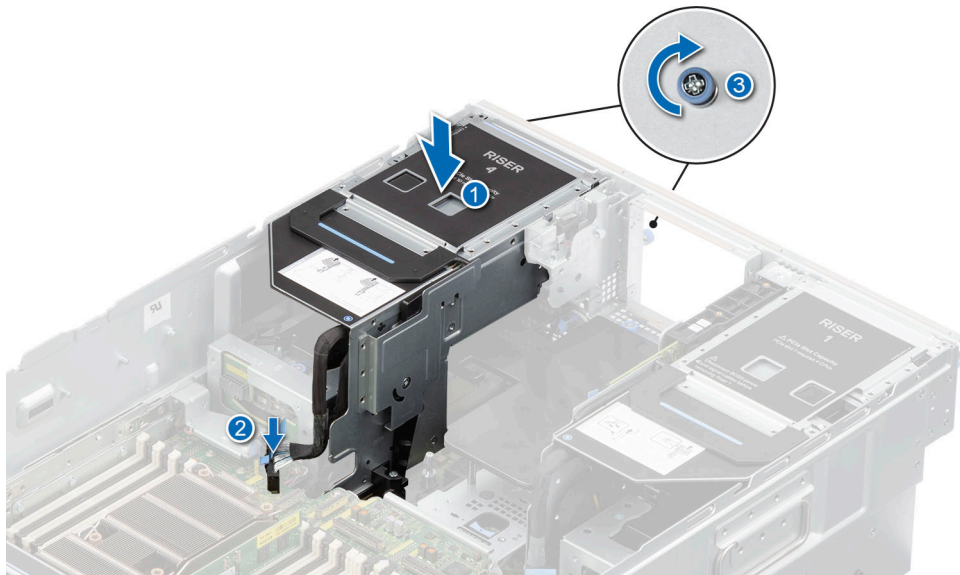

Figure 118. Installing the expansion card riser 4

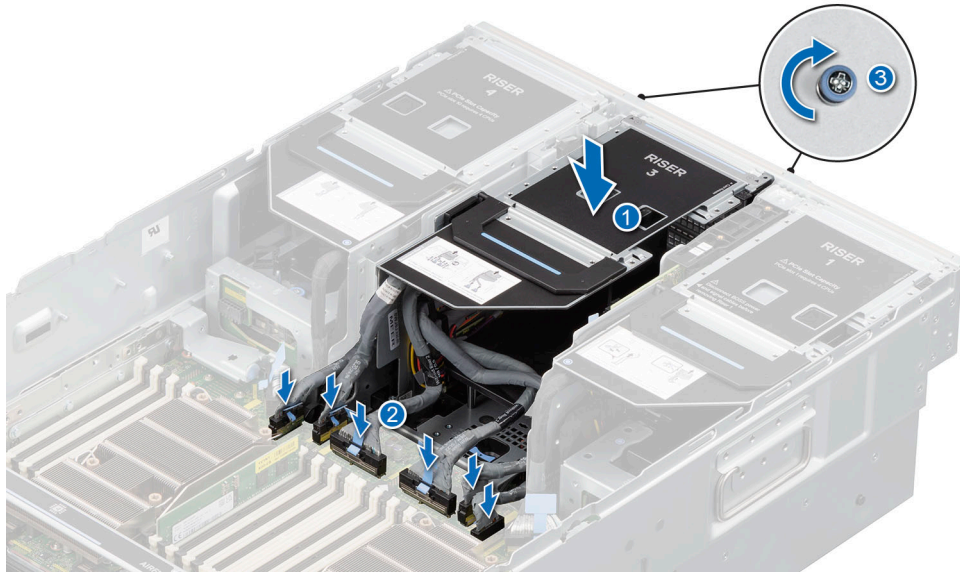

Figure 119. Installing the expansion card riser 3

Next steps

1. If opened, close the cable holder on the system board.
2. If removed, [install the PEM](#).
3. Connect all the UPI cables and riser cables to the PEM connectors, observe the cable routing.
i **NOTE:** See [cable routing](#) section for more information.
4. If removed, connect the BOSS-N1 signal and power cable to the connectors on the BOSS module.
5. [Install the air shroud](#).
6. [Install the cooling fan cage assembly](#).
7. [Install the air shroud top cover](#).
8. [Install the support bar](#).
9. Follow the procedure listed in [After working inside your system](#).
10. Install any device drivers required for the card as described in the documentation for the card.

Removing expansion card from the expansion card riser

Prerequisites

1. Follow the safety guidelines listed in the [Safety instructions](#).
2. Follow the procedure listed in the [Before working inside your system](#).
3. [Remove the support bar](#).
4. [Remove the air shroud top cover](#).
5. [Remove the cooling fan cage assembly](#).
6. [Remove the air shroud](#).
7. i **NOTE:** If BOSS-N1 module is installed, be sure to disconnect the BOSS-N1 power cable and Signal cable before removing the riser 1 cage.
8. If required, disconnect the UPI and riser cables from the PEM, observe the cable routing.
i **NOTE:** See [cable routing](#) section for more information.
9. [Remove the expansion card riser](#)
10. If required, [remove the PEM](#) to disconnect the riser cable connectors from the system board.
11. [Remove the riser air shroud](#) to access VGA bracket and riser 2.
12. If required, open the cable holder on the system board to access riser cables.
13. For supported riser configurations, see the [Expansion card installation guidelines](#) section.

Steps

1. Press the retention latch touch point and tilt the expansion card retention latch lock to open.
2. Before removing the card from the riser, tilt the card holder by pressing the touch point on the card holder.
3. Hold the expansion card by the edges and pull the card from the riser.

i **NOTE:** The numbers on the image do not depict the exact steps. The numbers are for representation of sequence.

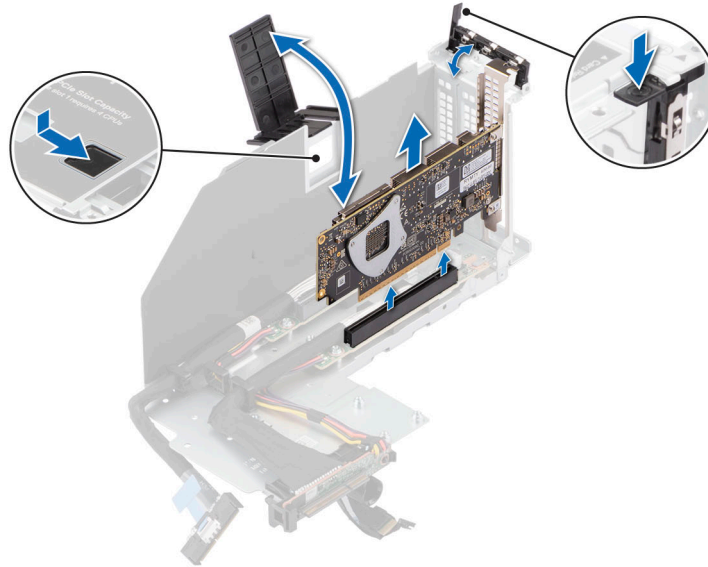

Figure 120. Removing expansion card from the expansion card riser

4. If the expansion card is not going to be replaced, install a filler bracket and close the card retention latch.

i **NOTE:** You must install a filler bracket over an empty expansion card slot to maintain Federal Communications Commission (FCC) certification of the system. The brackets also keep dust and dirt out of the system and aid in proper cooling and airflow inside the system.

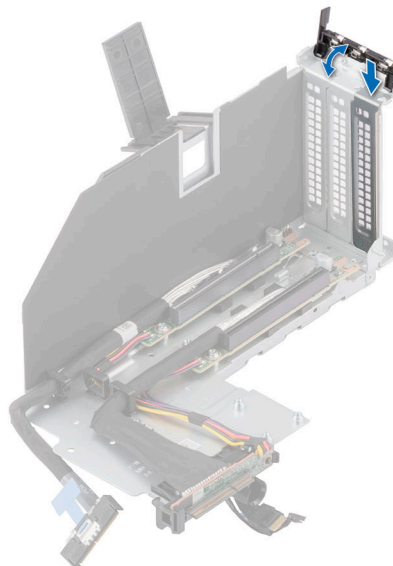





Figure 121. Installing the filler bracket

Next steps

1. If applicable, [install an expansion card into the expansion card riser](#).

Installing an expansion card into the expansion card riser

Prerequisites

1. Follow the safety guidelines listed in the [Safety instructions](#).
2. Follow the procedure listed in the [Before working inside your system](#).
3. [Remove the air shroud top cover](#).
4. [Remove the cooling fan cage assembly](#).
5. [Remove the air shroud](#).
6.  **NOTE:** If BOSS-N1 module is installed, be sure to disconnect the BOSS-N1 power cable and Signal cable before removing the riser 1 cage.
7. If required, disconnect the UPI and riser cables from the PEM, observe the cable routing.
 **NOTE:** See [cable routing](#) section for more information.
8. [Remove the expansion card riser](#)
9. If required, [remove the PEM](#) to disconnect the riser cable connectors from the system board.
10. [Remove the riser air shroud](#) to access VGA bracket and riser 2.
11. If required, open the cable holder on the system board to access riser cables.
12. For supported riser configurations, see the [Expansion card installation guidelines](#) section.
13. If installing a new expansion card, unpack it and prepare the card for installation.
 **NOTE:** For instructions, see the documentation accompanying the card.

 **CAUTION:** Do not install GPUs, network cards, or other PCIe devices on your system that are not validated and tested by Dell. Damage caused by unauthorized and invalidated hardware installation will null and void the system warranty.

Steps

1. Press the retention latch touch point and tilt the expansion card retention latch lock to open.
2. If installed, remove the filler bracket.
 **NOTE:** Store the filler bracket for future use. Filler brackets must be installed in empty expansion card slots to maintain Federal Communications Commission (FCC) certification of the system. The brackets also keep dust and dirt out of the system and aid in proper cooling and airflow inside the system.

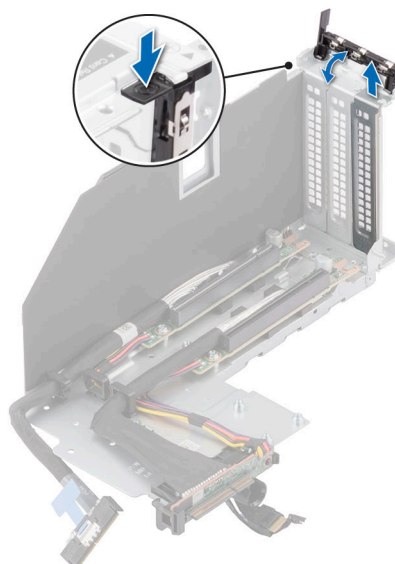

Figure 122. Removing the filler bracket

3. Hold the card by edges, and align the card with the connector on the riser.
4. Insert the card firmly into the expansion card connector until seated.
5. Close the expansion card retention latch.

6. Tilt and push the card holder to hold the card in the riser.

i **NOTE:** The numbers on the image do not depict the exact steps. The numbers are for representation of sequence.



Figure 123. Installing an expansion card into the expansion card riser

Next steps

1. If required, connect the cables from the risers to the system board.
2. [Install the expansion card risers.](#)
3. [Install the riser air shroud](#) after installing the riser 2 and VGA bracket.
4. If opened, close the cable holder on the system board.
5. If removed, [install the PEM.](#)
6. If removed, connect all the UPI cables and riser cables to the PEM connectors, observe the cable routing.
i **NOTE:** See [cable routing](#) section for more information.
7. If removed, connect the BOSS-N1 signal and power cable to the connectors on the BOSS module.
8. [Install the air shroud.](#)
9. [Install the cooling fan cage assembly.](#)
10. [Install the air shroud top cover.](#)
11. [Install the support bar.](#)
12. Follow the procedure listed in [After working inside your system.](#)
13. Install any device drivers required for the card as described in the documentation for the card.

Removing the full length expansion card risers

Prerequisites

1. Follow the safety guidelines listed in the [Safety instructions.](#)
2. Follow the procedure listed in the [Before working inside your system.](#)
3. [Remove the support bar.](#)
4. [Remove the air shroud top cover.](#)
5. [Remove the cooling fan cage assembly.](#)
6. **i** **NOTE:** If BOSS-N1 module is installed, be sure to disconnect the BOSS-N1 power cable and signal cable before removing the riser 1 cage.
7. Disconnect all the riser cables from the PEM connectors, observe the cable routing.
i **NOTE:** See [cable routing](#) section for more information.
8. For supported riser configurations, see the [Expansion card installation guidelines](#) section.

Steps

To remove full length expansion card riser:

- a. Loosen the captive screws on the riser and system.
- b. Rotate the riser handle to unlock the riser from the system.
- c. Holding the riser handle and edges lift the expansion card risers from the connector on the system board.

CAUTION: To avoid damaging the riser connectors, place the riser on the riser air shroud or the adjacent riser facing card holder side on top.

- d. Disconnect the GPU power cables and signal cables from the system board, PEM, and power distribution board (PDB).

NOTE: The numbers on the image do not depict the exact steps. The numbers are for representation of sequence.

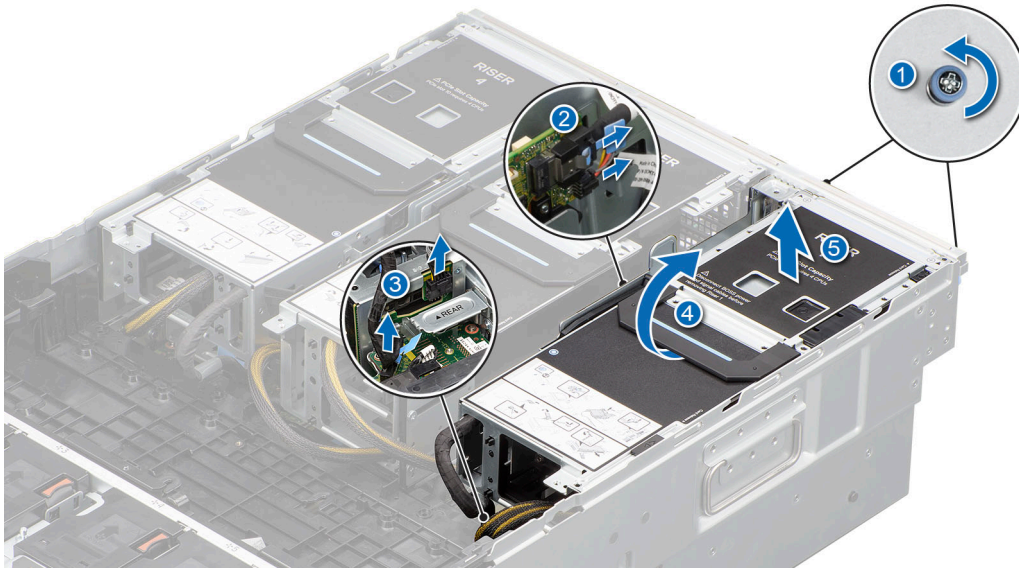

Figure 124. Removing the expansion card riser 1

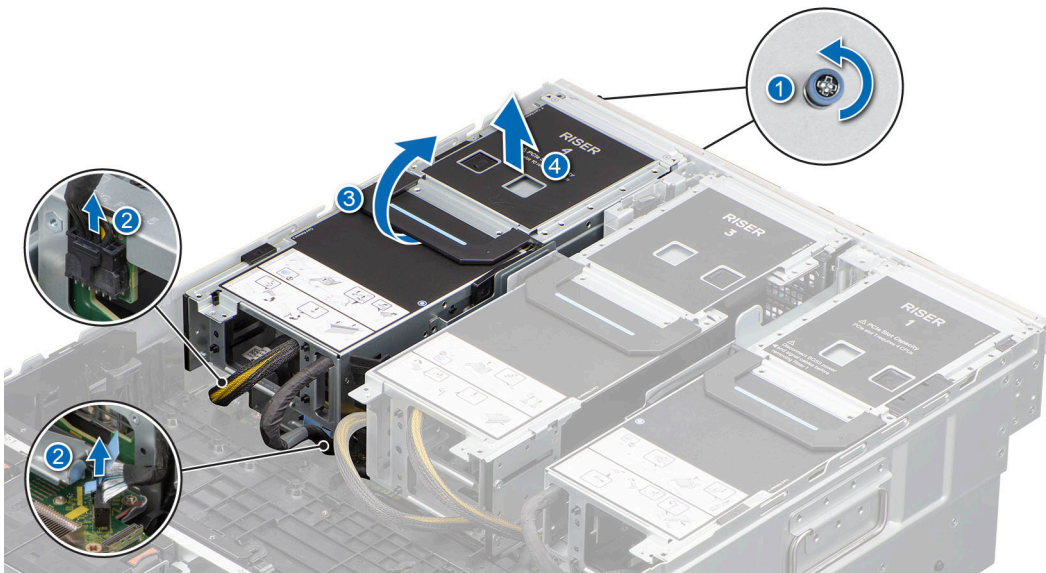

Figure 125. Removing the expansion card riser 4

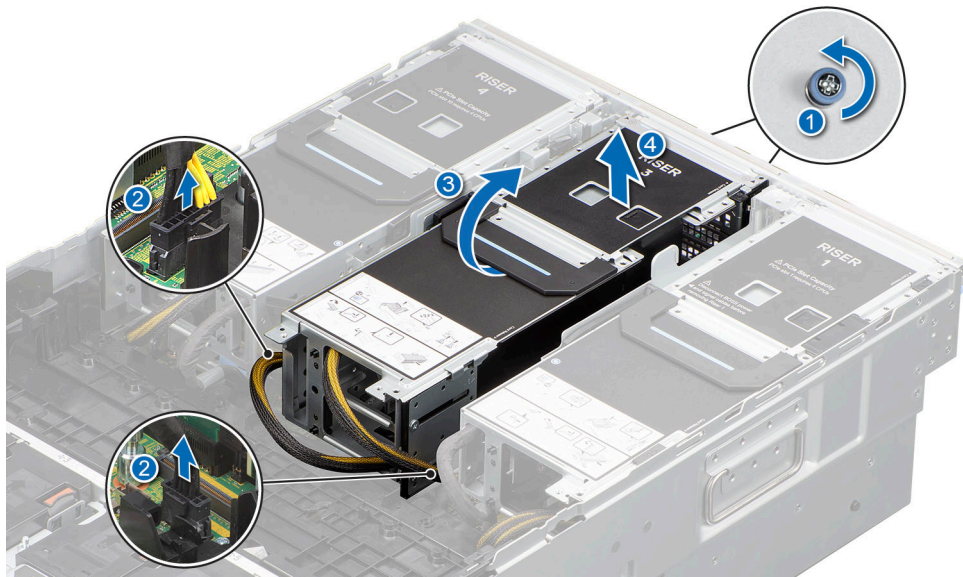

Figure 126. Removing the expansion card riser 3

CAUTION: To remove riser 3, disconnect the riser 3 signal cable connectors from the PEM and remove riser 1 and riser 4 to access riser 3 power cables on the system board.

Next steps

1. [Replace the full length expansion card riser.](#)

Installing the full length expansion card risers

Prerequisites

1. Follow the safety guidelines listed in the [Safety instructions](#).
 2. Follow the procedure listed in the [Before working inside your system](#).
 3. [Remove the support bar](#).
 4. [Remove the air shroud top cover](#).
 5. [Remove the cooling fan cage assembly](#).
 6. **i** **NOTE:** If BOSS-N1 module is installed, be sure to disconnect the BOSS-N1 power cable and Signal cable before removing the Riser 1 cage.
 7. Disconnect all the riser cables from the PEM connectors, observe the cable routing.
 - i** **NOTE:** See [cable routing](#) section for more information.
 8. If removed, [install the GPU into the expansion card risers](#).
 9. For supported riser configurations, see the [Expansion card installation guidelines](#) section.
- i** **NOTE:** Full length risers are supported only in riser 1, riser 3, and riser 4 slot.

Steps

To install the full length expansion card risers:

- a. Place the riser on the riser air shroud or the adjacent riser, facing card holder side on top.
- b. Connect the GPU power cables and signal cables to the system board, PEM, and power distribution board (PDB).
- c. Holding the riser handle, align the holes on the expansion card riser with the guides on the system board.
- d. Lower the expansion card riser into place and press the touch points until the expansion card riser connector is fully seated on the system board connector.
- e. Tighten the captive screws on the risers and system if any.
 - i** **NOTE:** To avoid damaging to the cables, route the cables properly.

NOTE: The numbers on the image do not depict the exact steps. The numbers are for representation of sequence.

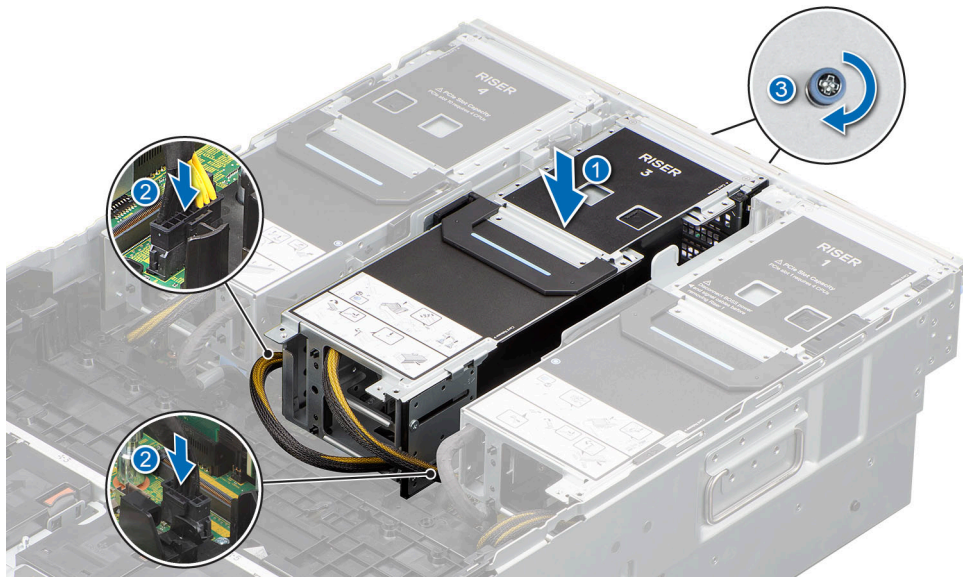

Figure 127. Installing the expansion card riser 3

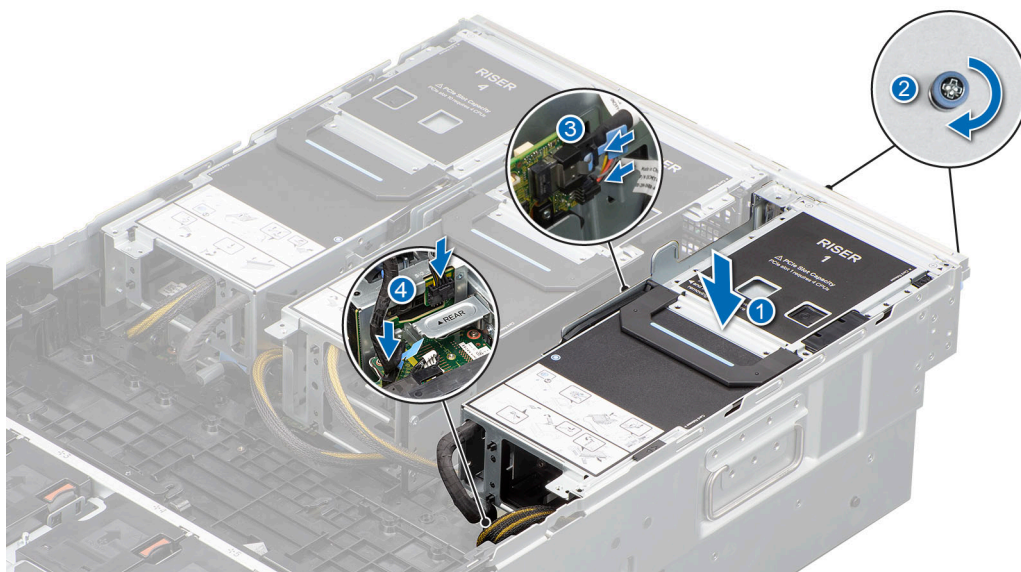

Figure 128. Installing the expansion card riser 1

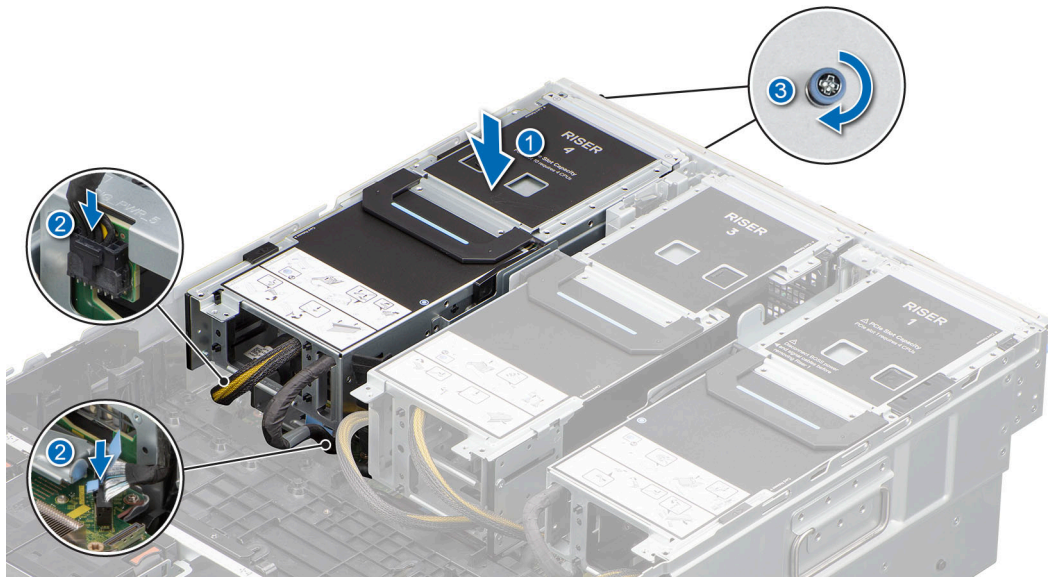

Figure 129. Installing the expansion card riser 4

Next steps

1. Connect all the riser cables to the PEM connectors, observe the cable routing.
 - i** **NOTE:** See [cable routing](#) section for more information.
2. If removed, connect the BOSS-N1 signal and power cable to the connectors on the BOSS module.
3. [Install the cooling fan cage assembly.](#)
4. [Install the air shroud top cover.](#)
5. [Install the support bar.](#)
6. Follow the procedure listed in [After working inside your system.](#)
7. Install any device drivers required for the card as described in the documentation for the card.

Removing a GPU

Prerequisites

1. Follow the safety guidelines listed in the [Safety instructions.](#)
2. Follow the procedure listed in the [Before working inside your system.](#)
3. [Remove the support bar.](#)
4. [Remove the air shroud top cover.](#)
5. [Remove the cooling fan cage assembly.](#)
6. [Remove the full length expansion card riser.](#)

i **NOTE:** See [cable routing](#) section for more information.

Steps

1. To remove the GPU from Risers:
 - a. Slide the expansion card retention latch on the riser .
 - b. Before removing the card from the riser, pull and tilt the card holder by pressing the touch point on the card holder.
 - c. Press and tilt the expansion card holder latch on the riser.
 - d. Disconnect the GPU power cable from the GPU card.
 - e. Hold the GPU card by the edges and pull the card from the riser.

i **NOTE:** The numbers on the image do not depict the exact steps. The numbers are for representation of sequence.

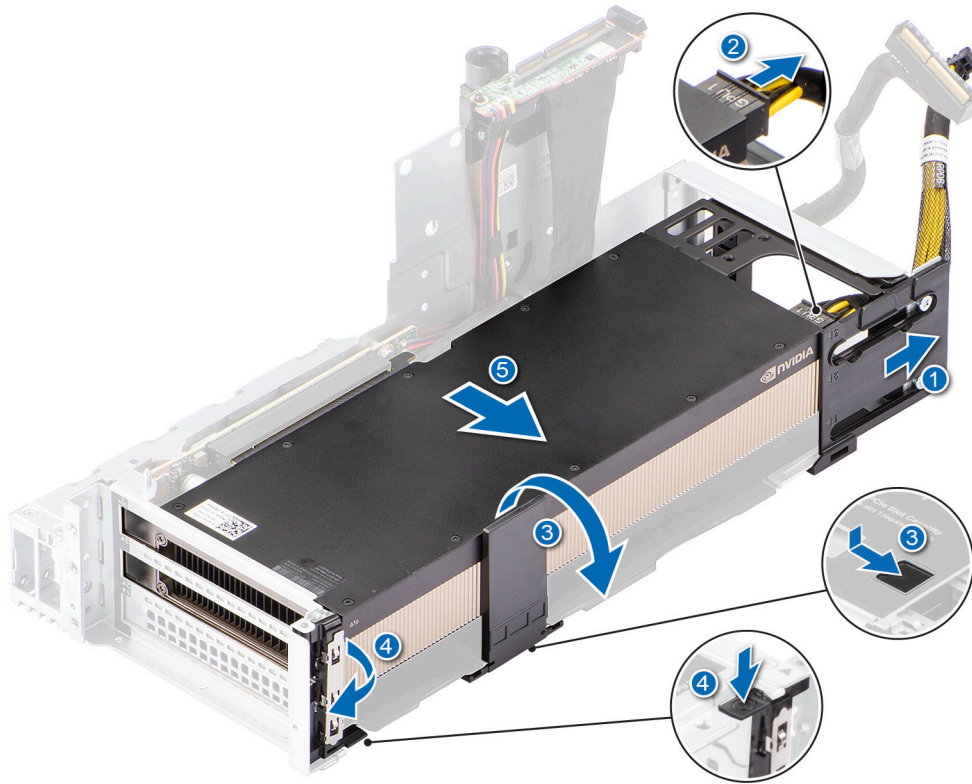

Figure 130. Removing the GPU from Riser 1

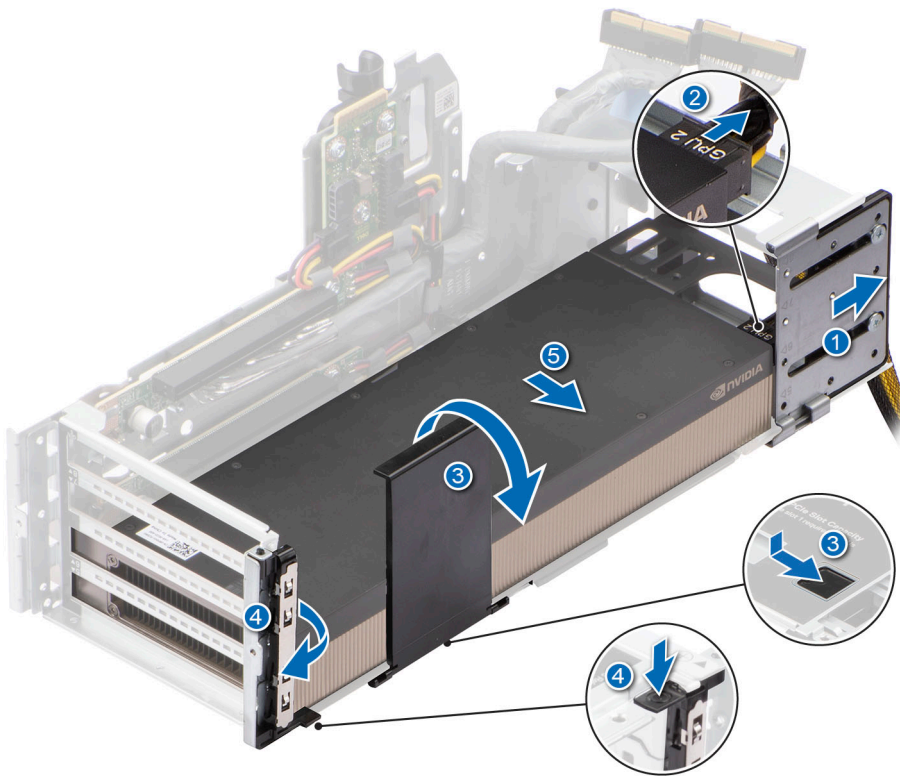

Figure 131. Removing the GPU from Riser 3

NOTE: Follow the same procedure, if two GPU cards are available in riser3.

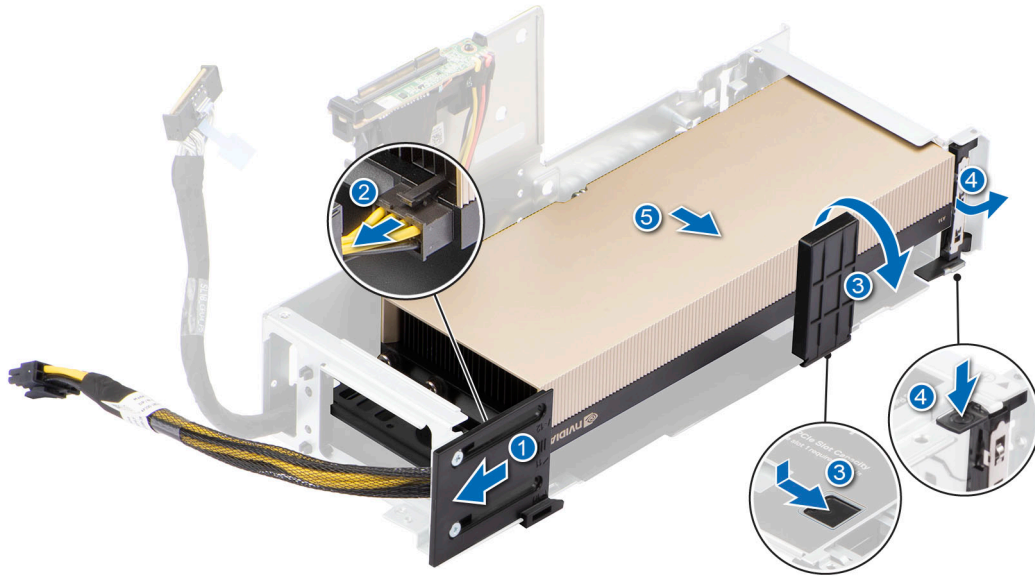

Figure 132. Removing the GPU from Riser 4

2. If removing the GPU permanently, install a filler bracket.

NOTE: You must install a filler bracket over an empty expansion card slot to maintain Federal Communications Commission (FCC) certification of the system. The brackets also keep dust and dirt out of the system and aid in proper cooling and airflow inside the system. The filler bracket is necessary to maintain proper thermal conditions.

3. Install a metal filler bracket over the empty expansion slot opening and close the expansion card latch.

Next steps

1. [Replace the GPU.](#)

Installing a GPU

Prerequisites

1. Follow the safety guidelines listed in the [Safety instructions](#).
2. Follow the procedure listed in the [Before working inside your system](#).
3. [Remove the support bar.](#)
4. [Remove the air shroud top cover.](#)
5. [Remove the cooling fan cage assembly.](#)
6. [Remove the full length expansion card riser.](#)

NOTE: See [cable routing](#) section for more information.

CAUTION: Do not install GPUs, network cards, or other PCIe devices on your system that are not validated and tested by Dell. Damage caused by unauthorized and invalidated hardware installation will null and void the system warranty.

WARNING: Consumer-Grade GPU should not be installed or used in the Enterprise Server products.

CAUTION: Do not mix the GPUs, as all the installed GPUs must be of the same type and model.

Steps

1. If installed, remove the filler bracket.

NOTE: Store the filler bracket for future use. Filler brackets must be installed in empty expansion card slots to maintain Federal Communications Commission (FCC) certification of the system. The brackets also keep dust and dirt out of the system and aid in proper cooling and airflow inside the system.

2. To install the GPU on Risers:
 - a. Connect the GPU power cable to the GPU card.
 - b. Align the connector on the GPU with the connector on the riser.
 - c. Insert the GPU into the riser until firmly seated.
 - d. Tilt the expansion card holder latch.
 - e. Tilt and push the card holder latch to secure the GPU card to the riser.
 - f. Slide the expansion card latch on the riser.

NOTE: The numbers on the image do not depict the exact steps. The numbers are for representation of sequence.

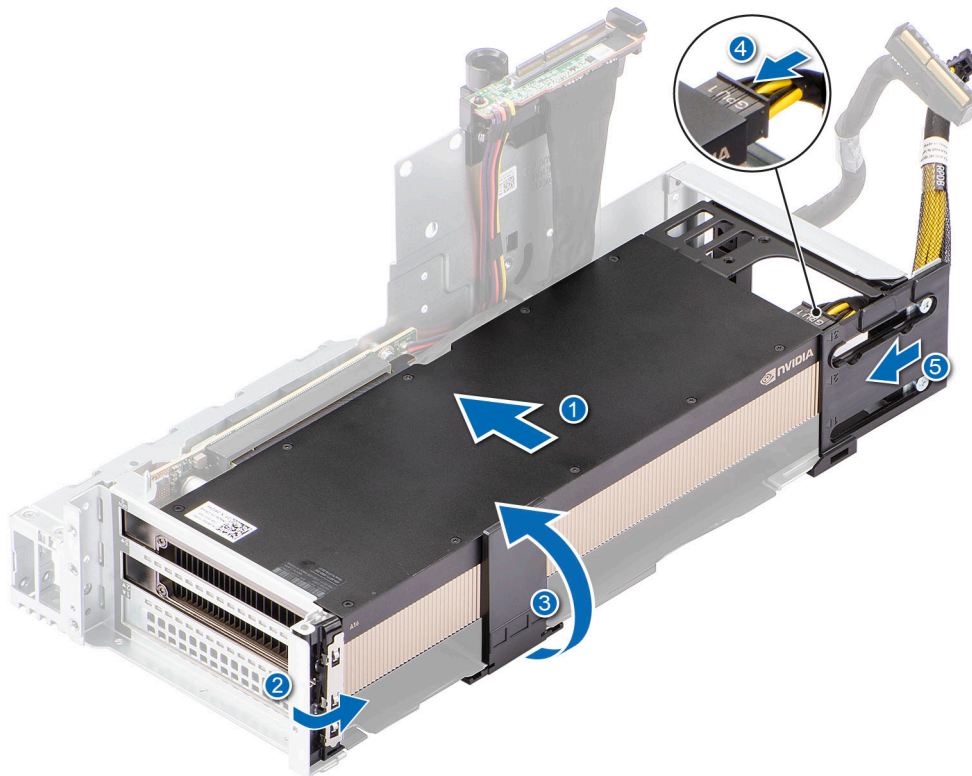

Figure 133. Installing GPU on Riser 1

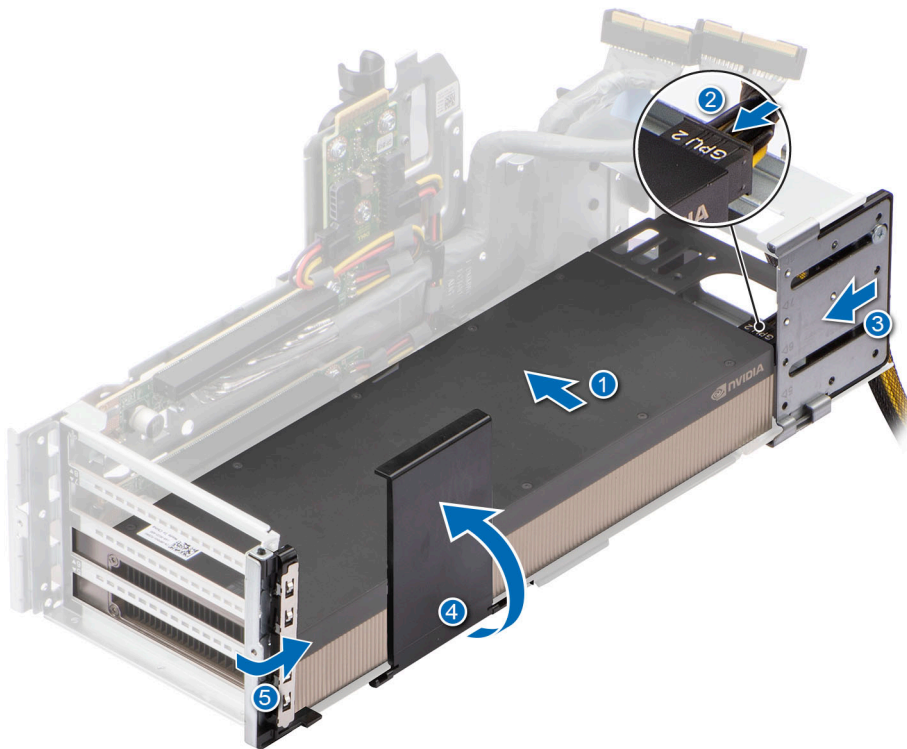

Figure 134. Installing GPU on Riser 3

NOTE: Follow the same procedure, if two GPU cards are available in riser3.

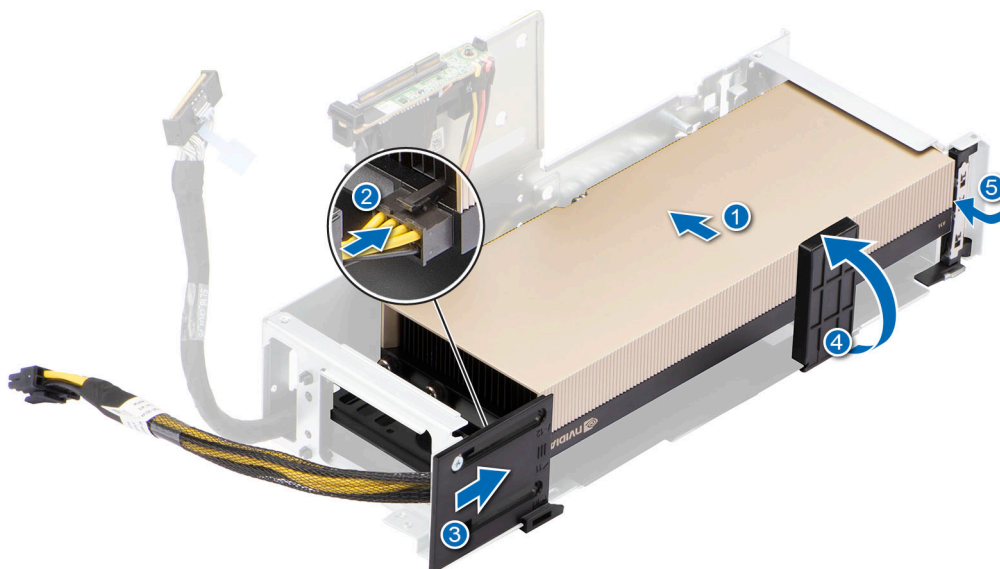

Figure 135. Installing GPU on Riser 4

Next steps

1. If removed, connect the BOSS-N1 signal and power cable to the connectors on the BOSS module.
2. Install the full length expansion card riser
3. Install the cooling fan cage assembly.
4. Install the air shroud top cover.

5. [Install the support bar.](#)
6. Follow the procedure listed in [After working inside your system.](#)
7. Install any device drivers required for the card as described in the documentation for the card.

Power distribution board

This is a service technician replaceable part only.

Removing the power distribution board

There are power distribution boards (PDB) on either side of the system. The procedure to remove is similar.

Prerequisites

1. Follow the safety guidelines listed in the [Safety instructions.](#)
2. Follow the procedure listed in the [Before working inside your system.](#)
3. [Remove the support bar.](#)
4. [Remove the air shroud top cover.](#)
5. [Remove the cooling fan cage assembly.](#)
6. If required, [Remove the air shroud.](#)
7. [Remove the expansion card risers](#) or [remove the full length expansion card riser.](#)
i **NOTE:** See [cable routing](#) section for more information.
8. [Remove the riser air shroud.](#)
9. [Remove the PSU.](#)

Steps

1. Loosen the captive screw.
2. Holding the touch point firmly lift the PDB from the system.

i **NOTE:** The numbers on the image do not depict the exact steps. The numbers are for representation of sequence.

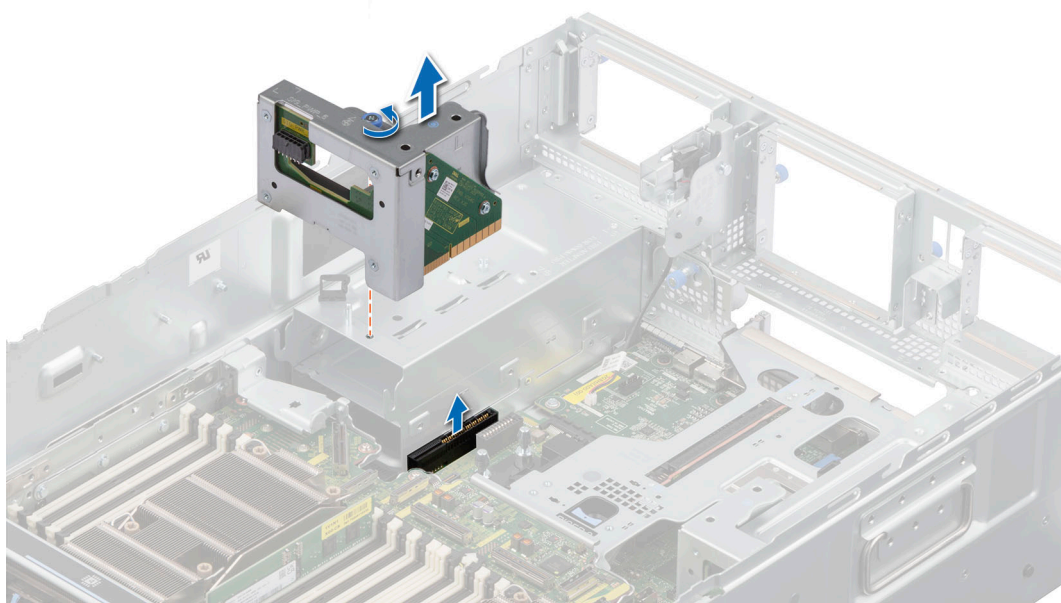

Figure 136. Removing the PDB

Next steps

1. [Replace the power distribution board.](#)

Installing the power distribution board

Prerequisites

1. Follow the safety guidelines listed in the [Safety instructions](#).
2. Follow the procedure listed in the [Before working inside your system](#).
3. [Remove the support bar.](#)
4. [Remove the air shroud top cover.](#)
5. [Remove the cooling fan cage assembly.](#)
6. If required, [Remove the air shroud.](#)
7. [Remove the expansion card risers](#) or [remove the full length expansion card riser.](#)

i **NOTE:** See [cable routing](#) section for more information.

8. [Remove the riser air shroud.](#)
9. [Remove the PSU.](#)

Steps

1. Align and lower the power distribution board (PDB) into the system board slot.
2. Press the blue touch point on the PDB until seated firmly.
3. Tighten the captive screw.

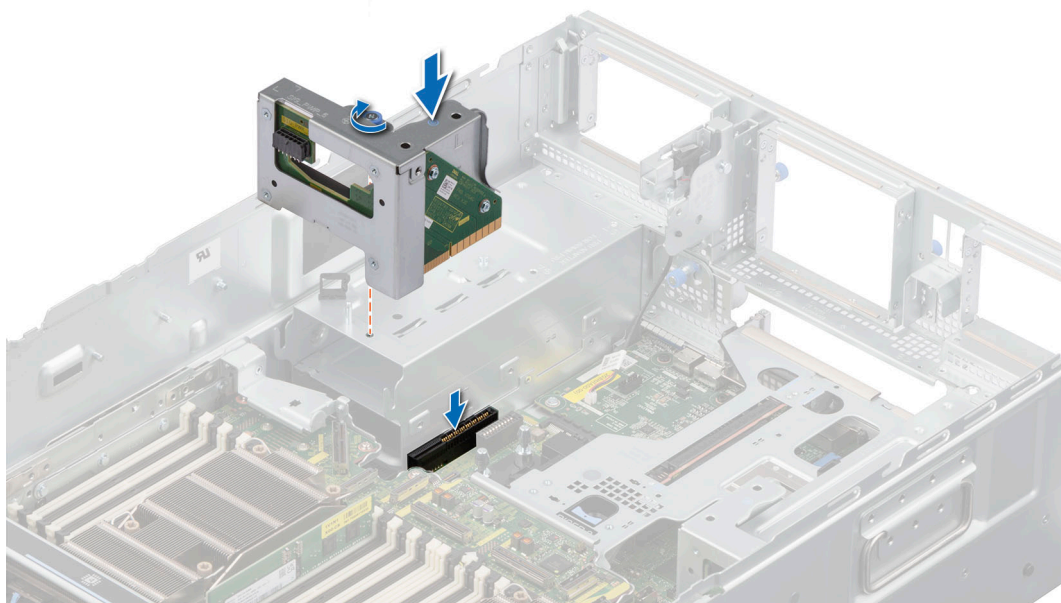

Figure 137. Installing the PDB

Next steps

1. [Install the PSU.](#)
2. [Install the riser air shroud.](#)
3. [Install the expansion card risers](#) or [Install the full length expansion card riser.](#)
4. If removed, [Install the air shroud](#)
5. [Install the cooling fan cage assembly.](#)
6. [Install the air shroud top cover.](#)
7. [Install the support bar.](#)
8. Follow the procedure listed in [After working inside your system](#).

Processor and heat sink module

This is a service technician replaceable part only.

Removing the processor and heat sink module

Prerequisites

1. Follow the safety guidelines listed in the [Safety instructions](#).
2. Follow the procedure listed in the [Before working inside your system](#).
3. [Remove the support bar](#).
4. [Remove the air shroud top cover](#).
5. [Remove the cooling fan cage assembly](#).
6. [Remove the air shroud](#) or [remove the GPU air shroud](#).
i **NOTE:** The GPU air shroud can be removed only after the full length expansion card risers have been removed.
7. If installed, [Remove the full length expansion card risers](#).
i **NOTE:** The heat sink and processor are hot to touch for some time after the system has been powered off. Allow the heat sink and processor to cool down before handling them.
8. [Remove the PEM](#), if the system board processor and heat sink module (PHM) must be accessed.

Steps

1. Ensure all four anti-tilt wires are in the locked position (outward position), and then using a Torx T30 screwdriver, loosen the captive nuts on the PHM in the order that is mentioned below:
 - a. Loosen the first nut three turns.
 - b. Loosen the nut diagonally opposite to the nut you loosened first.
 - c. Repeat the procedure for the remaining two nuts.
 - d. Return to the first nut and loosen it completely.
i **NOTE:** Ensure that the anti-tilt wires on the PHM are in locked position when loosening the captive nuts.
2. Set all the anti-tilt wires to unlocked position (inward position).

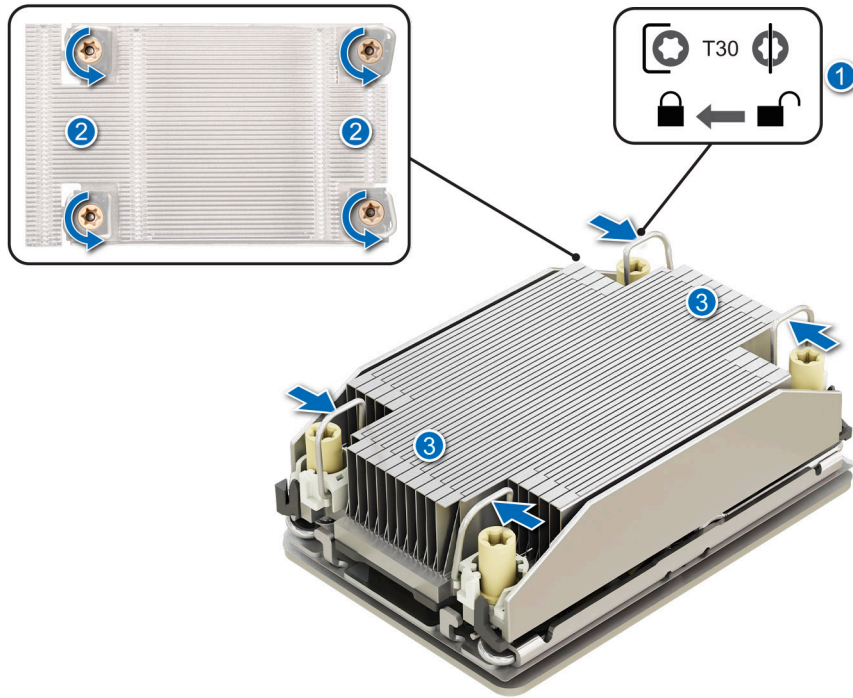

Figure 138. Removing the processor heat sink module

3. Lift the PHM from the system board or processor expansion module and set the PHM aside with the processor side facing up.

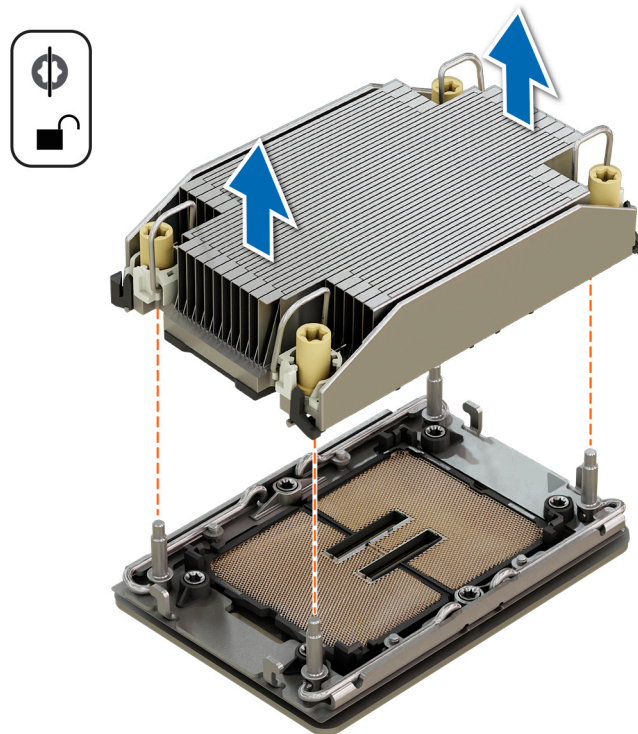

Figure 139. Removing a heat sink

Next steps

If you are removing a faulty heat sink, [replace the heat sink](#), if not, [remove the processor](#).

Removing the processor

Prerequisites

⚠ WARNING: Remove the processor from processor and heat sink module (PHM) only if you are replacing the processor or heat sink.

1. Follow the safety guidelines listed in the [Safety instructions](#).
2. Follow the procedure listed in the [Before working inside your system](#).
3. [Remove the support bar](#).
4. [Remove the air shroud top cover](#).
5. [Remove the cooling fan cage assembly](#).
6. [Remove the air shroud or remove the GPU air shroud](#).

i NOTE: The GPU air shroud can be removed only after the full length expansion card risers have been removed.

7. [Remove the PEM](#), if the system board processor and heat sink module (PHM) must be accessed.
8. If required, [Remove the full length expansion card risers](#).
9. [Remove the processor heat sink module](#).

⚠ CAUTION: You may find the CMOS battery loss or CMOS checksum error that is displayed during the first instance of powering on the system after the processor or system board replacement which is expected. To fix this, simply go to setup option to configure the system settings.

Steps

1. Place the heat sink with the processor side facing up.
2. Using your thumb, lift the thermal interface material (TIM) break lever to release the processor from the TIM and retaining clip.
3. Holding the processor by the edges, lift the processor away from the retaining clip.

i NOTE: Ensure to hold the retaining clip to the heat sink as you lift the TIM break lever.

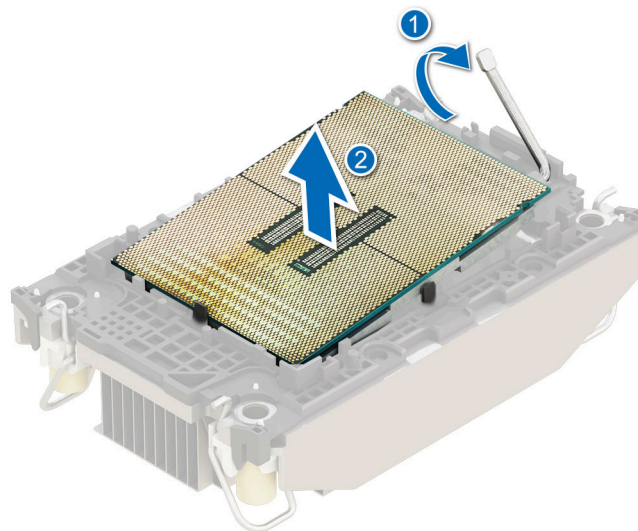

Figure 140. Removing the processor

i NOTE: Ensure to return the TIM break lever back to original position.

4. Using your thumb and index finger, first hold the retaining clip release tab at the pin 1 connector, pull out the tip of the retaining clip release tab, and then lift the retaining clip partially from the heat sink.
5. Repeat the procedure at the remaining three corners of the retaining clip.
6. After all the corners are released from the heat sink, lift the retaining clip from the pin 1 corner of the heat sink.

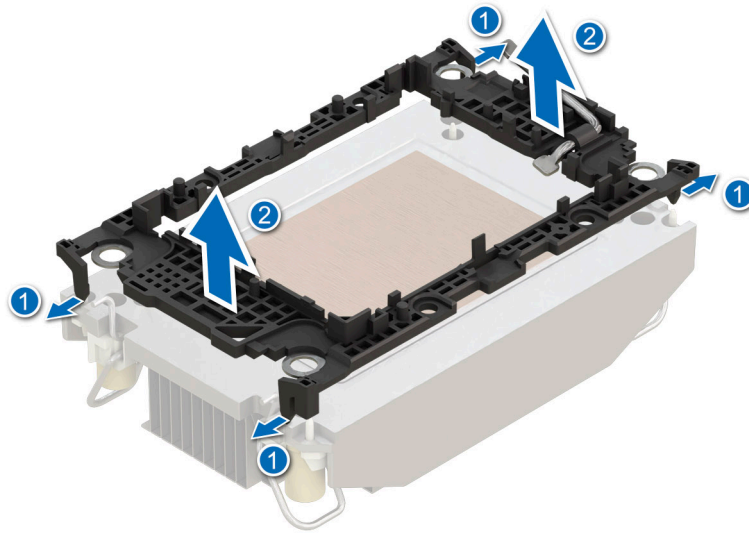

Figure 141. Removing the retaining clip

Next steps

Replace the processor.

Installing the processor

Prerequisites

1. Follow the safety guidelines listed in the [Safety instructions](#).
2. Follow the procedure listed in the [Before working inside your system](#).
3. [Remove the support bar](#).
4. [Remove the air shroud top cover](#).
5. [Remove the cooling fan cage assembly](#).
6. [Remove the air shroud](#) or [remove the GPU air shroud](#).
i **NOTE:** The GPU air shroud can be removed only after the full length expansion card risers have been removed.
7. [Remove the PEM](#), if the system board processor and heat sink module (PHM) must be accessed.
8. If required, [Remove the full length expansion card risers](#).
9. [Remove the processor heat sink module](#).

Steps

1. Place the processor in the processor tray.
i **NOTE:** Ensure the pin 1 indicator on the processor tray is aligned with the pin 1 indicator on the processor.
2. Place the retaining clip on top of the processor in the processor tray aligning pin 1 indicator on the processor.
i **NOTE:** Ensure the pin 1 indicator on the retaining clip is aligned with the pin 1 indicator on the processor before placing the retaining clip on the processor.
i **NOTE:** Before you install the heat sink, ensure to place the processor and retaining clip in the tray.

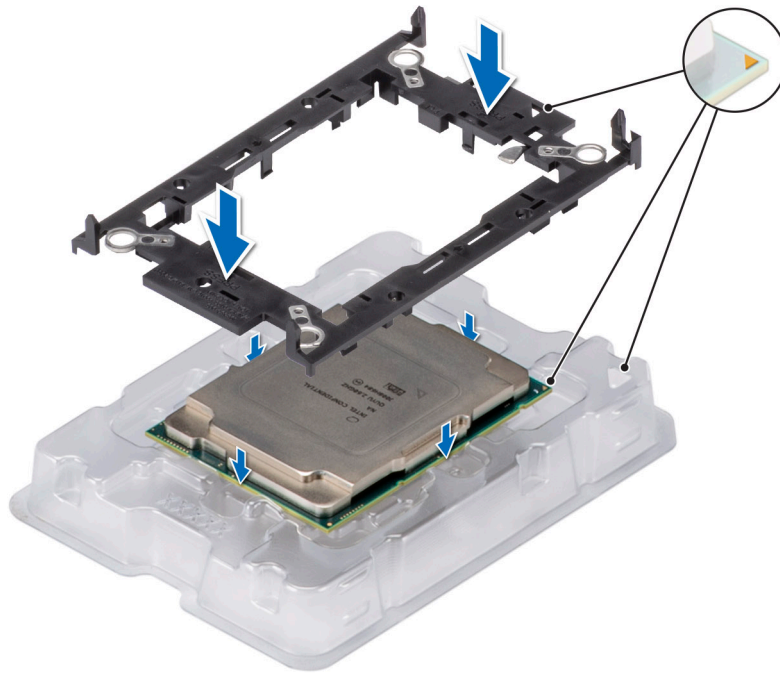

Figure 142. Installing the retaining clip

3. Align the processor with retaining clip, by using your fingers press the retaining clip on all the four sides until it clicks into place.

i **NOTE:** Ensure that the processor is securely latched to the retaining clip.

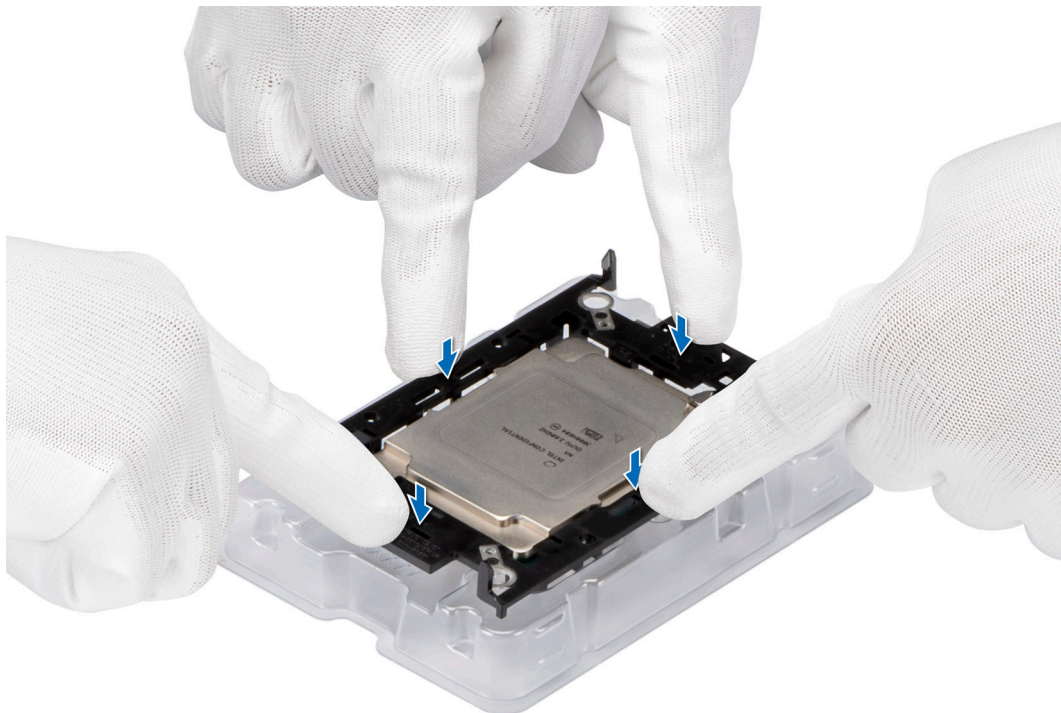

Figure 143. Press the retaining clip on the four sides

4. If you are using an existing heat sink, remove the thermal grease from the heat sink by using a clean lint-free cloth.
5. Apply the thermal grease in a thin spiral design on the bottom of the heat sink.

⚠ CAUTION: Applying too much thermal grease can result in excess grease coming in contact with and contaminating the processor socket.

NOTE: The thermal grease syringe is intended for single use only. Dispose the syringe after you use it.

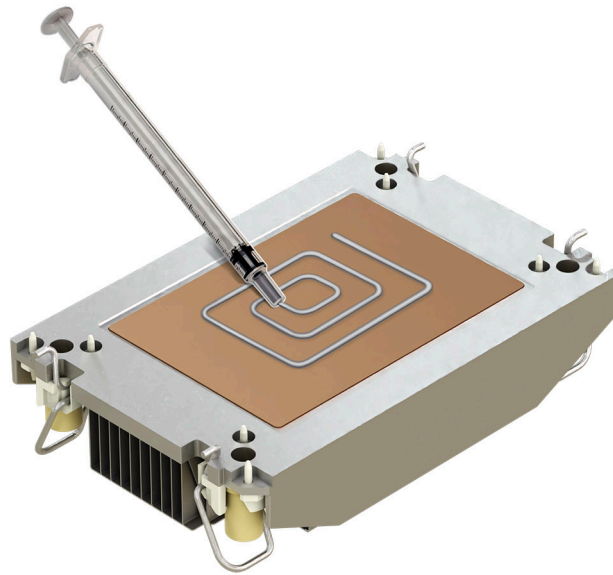

Figure 144. Applying thermal grease

6. For new heat sink, pull and remove the plastic cover from the base of heat sink.

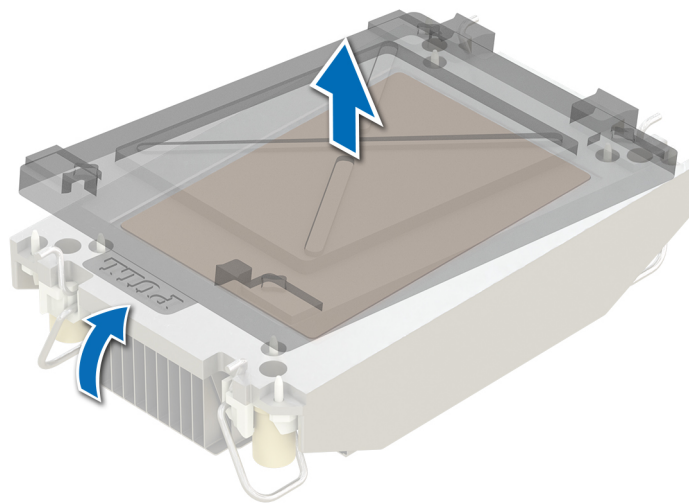

Figure 145. Removing the cover

7. Place the heat sink on the processor and press the base of the heat sink until the retaining clip locks onto the heat sink at all the four corners.

CAUTION: To avoid damaging the fins on the heat sink, do not press down on the heat sink fins.

NOTE:

- Ensure latching features on retaining clip, and heat sink are aligned during assembly.
- Ensure that the pin 1 indicator on the heat sink is aligned with the pin 1 indicator on the retaining clip before placing the heat sink onto the retaining clip.

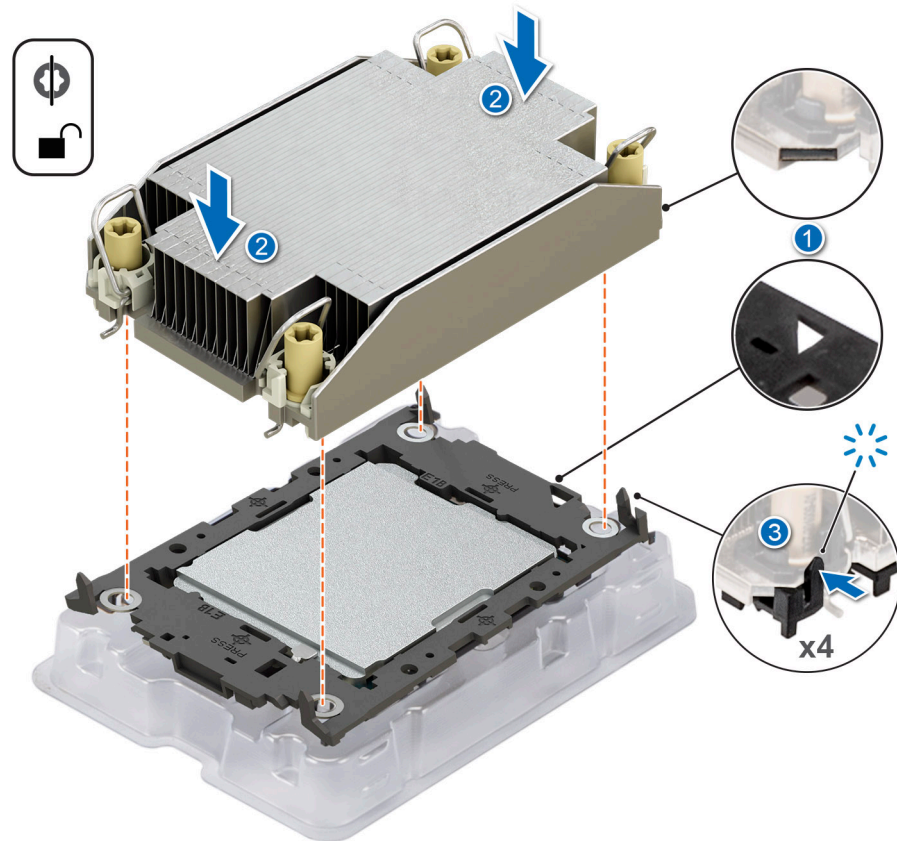

Figure 146. Installing the heat sink onto the processor

Next steps

1. Install the processor heat sink module.
2. If removed, install the PEM.
3. If removed, install the full length expansion risers.
4. **NOTE:** Before installing the full length expansion card risers, install the GPU air shroud.
5. Install the air shroud or install the GPU air shroud.
6. Install the cooling fan cage assembly.
7. Install the air shroud top cover.
8. Install the support bar.
9. Follow the procedure listed in *After working inside your system*.

Installing the processor and heat sink module

Prerequisites

Never remove the heat sink from a processor unless you intend to replace the processor or heat sink. The heat sink is necessary to maintain proper thermal conditions.

1. Follow the safety guidelines listed in the *Safety instructions*.
2. Follow the procedure listed in the *Before working inside your system*.
3. Remove the support bar.
4. Remove the air shroud top cover.
5. Remove the cooling fan cage assembly.
6. Remove the air shroud or remove the GPU air shroud.

7. **NOTE:** The GPU air shroud can be removed only after the full length expansion card risers have been removed.
8. If installed, Remove the full length expansion card risers.

NOTE: The heat sink and processor are hot to touch for some time after the system has been powered off. Allow the heat sink and processor to cool down before handling them.

8. Remove the PEM, if the system board processor and heat sink module (PHM) must be accessed.

Steps

1. Set the anti-tilt wires to the unlocked position on the heat sink (inward position).
2. Align the pin 1 indicator of the heat sink to the system board or processor expansion module, and then place the PHM on the processor socket.

CAUTION: To avoid damaging the fins on the heat sink, do not press down on the heat sink fins.

NOTE: Ensure that the PHM is held parallel to the system board to prevent damaging the components.

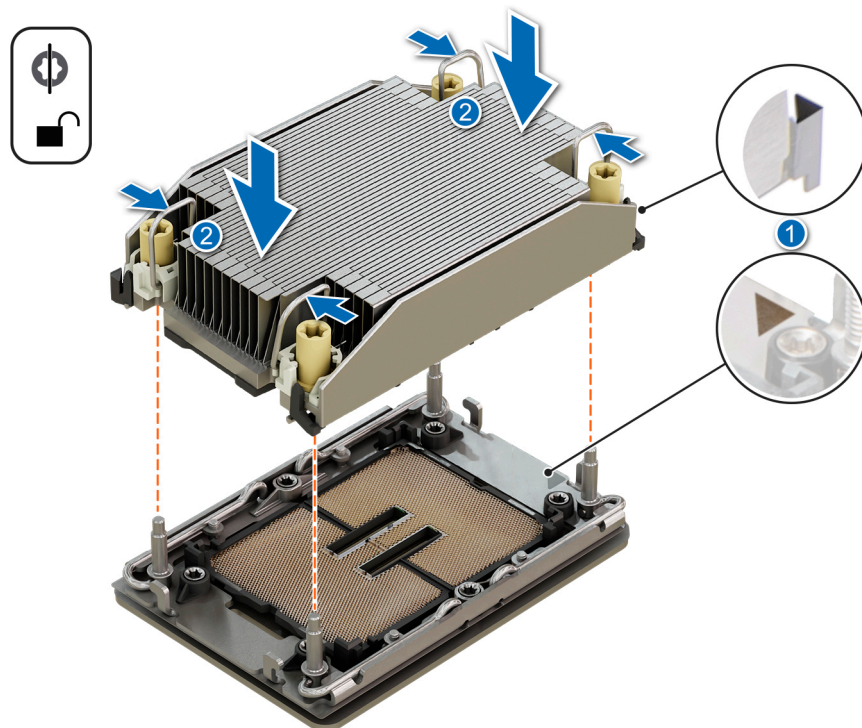

Figure 147. Installing the processor heat sink

3. Set the anti-tilt wires to the locked position (outward position), and then using the Torx T30 screwdriver, tighten the captive nuts (8 in-lbf) on the heat sink in the order below:
 - a. In a random order, tighten the first nut three turns.
 - b. Tighten the nut diagonally opposite to the nut that you tighten first.
 - c. Repeat the procedure for the remaining two nuts.
 - d. Return to the first nut to tighten it completely.
 - e. Check all the nuts to ensure they are firmly secured.

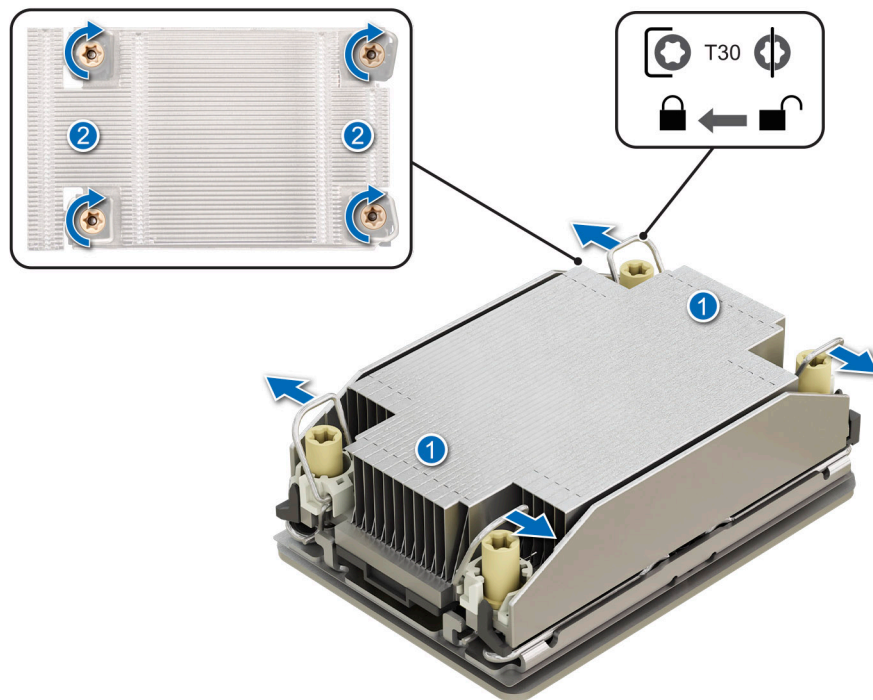

Figure 148. Set the anti-tilt wires to the locked position and tightening the nuts

Next steps

1. If removed, [install the PEM](#).
2. If removed, [install the full length expansion risers](#).
 - i** **NOTE:** Before installing the full length expansion card risers, install the GPU air shroud.
3. [Install the air shroud](#) or [install the GPU air shroud](#).
4. [Install the cooling fan cage assembly](#).
5. [Install the air shroud top cover](#).
6. [Install the support bar](#).
7. Follow the procedure listed in the [After working inside your system](#).

Processor expansion module

This is a service technician replaceable part only.

Removing the processor expansion module (PEM)

Prerequisites

- i** **NOTE:** A PEM is required to install the third and the fourth processors. In order to replace the PEM board, the complete PEM must be replaced.
- i** **NOTE:** Remove the faulty PEM from the system and transfer the DIMMs and processor heat sink modules to the replacement PEM before installing it in the system.

⚠ CAUTION: Do not lift the PEM board by holding the memory module, processor, or any other components. Use the handle bar on the module to lift.

1. Follow the safety guidelines listed in the [Safety instructions](#).
2. Follow the procedure listed in the [Before working inside your system](#).
3. [Remove the support bar](#).

4. Remove the air shroud top cover.
5. Remove the cooling fan cage assembly.
6. Remove the air shroud or remove the GPU air shroud.
 - i** **NOTE:** The GPU air shroud can be removed only after the full length expansion card risers have been removed.
7. Disconnect all the UPI and riser cables from the PEM, observe the cable routing.
 - i** **NOTE:** See [cable routing](#) section for more information.
8. If installed, remove the full length expansion card risers.
9. If required, remove the processor and heat sink module on the PEM
 - i** **NOTE:** Rotate the PEM handle to the mid position to remove the cables/connectors and the heat sink modules that are installed on the PEM board.

Steps

1. Rotate the PEM handle to unlock the PEM from the system.
2. Hold the handle, and lift the PEM away from the system.

⚠ CAUTION: Handle with care because the PEM is heavy, and lay it down on a flat surface.

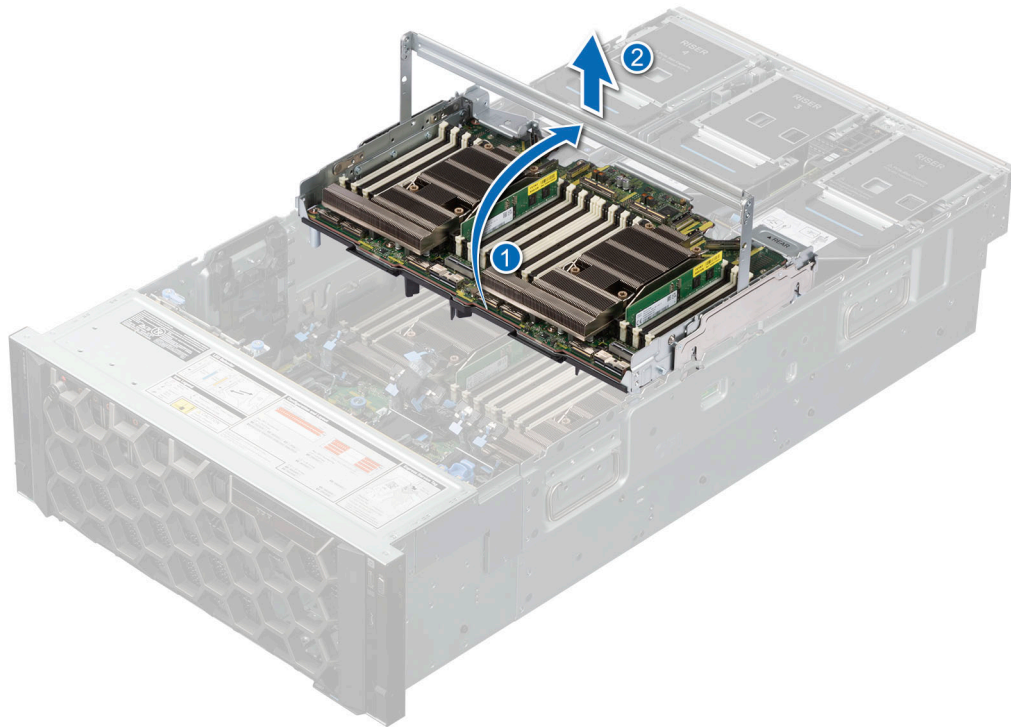

Figure 149. Removing the PEM

Next steps

1. Before replacing the processor expansion module (PEM):
 - a. Remove [Memory modules](#) from the faulty PEM
 - b. Remove [Processor and heat sink module](#) from the faulty PEM
 - i** **NOTE:** Rotate the PEM handle to the mid position to remove the heat sink modules installed on the faulty PEM.
 - c. Install [Processor and heat sink module](#) into the replacement PEM
 - i** **NOTE:** Rotate the PEM handle to the mid position to install the heat sink modules to the replacement PEM.
 - d. Install [Memory modules](#) into the replacement PEM
2. [Replace the processor expansion module.](#)

Installing the processor expansion module (PEM)

Prerequisites

i **NOTE:** A PEM is required to install the third and the fourth processors. In order to replace the PEM board, the complete PEM must be replaced.

i **NOTE:** Remove the faulty PEM from the system and transfer the DIMMs and processor heat sink modules to the replacement PEM before installing it in the system.

△ **CAUTION:** Do not lift the PEM by holding the memory module, processor, or any other components. Use the handle bar on the module to lift.

1. Follow the safety guidelines listed in the [Safety instructions](#).
2. Follow the procedure listed in the [Before working inside your system](#).
3. [Remove the support bar](#).
4. [Remove the air shroud top cover](#).
5. [Remove the cooling fan cage assembly](#).
6. [Remove the air shroud](#) or [remove the GPU air shroud](#).
i **NOTE:** The GPU air shroud can be removed only after the full length expansion card risers have been removed.
7. Disconnect all the UPI and riser cables from the PEM, observe the cable routing.
i **NOTE:** See [cable routing](#) section for more information.
8. If installed, [remove the full length expansion card risers](#).
9. If you are replacing the PEM, remove all the components that are listed in the [removing the processor expansion module](#) section.
10. Before replacing the processor expansion module (PEM):
 - a. Remove [Memory modules](#) from the faulty PEM
 - b. Remove [Processor and heat sink module](#) from the faulty PEM
i **NOTE:** Rotate the PEM handle to the mid position to remove the heat sink modules installed on the faulty PEM.
 - c. Install [Processor and heat sink module](#) into the replacement PEM
i **NOTE:** Rotate the PEM handle to the mid position to install the heat sink modules to the replacement PEM.
 - d. Install [Memory modules](#) into the replacement PEM

Steps

1. Holding the handle of the PEM, align the guide rails with the guides on the system.
2. Lower the PEM into the system until seated firmly.
3. Rotate the handle to lock the PEM into the system.

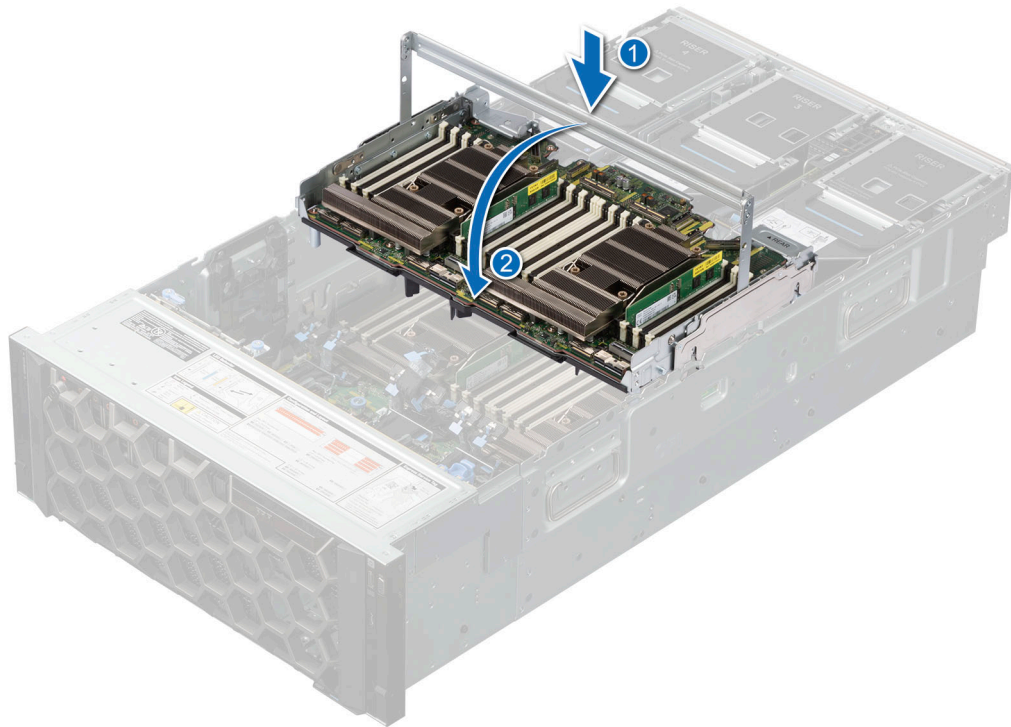

Figure 150. Installing the PEM

Next steps

1. If removed, [install processor and heat sink module](#) on the PEM.
i **NOTE:** Rotate the PEM module handle to the mid position to install the cables/connectors and the heat sink modules to the PEM board.
2. Connect all the UPI and riser cables to the PEM, observe the cable routing.
3. If removed, [Install the full length expansion risers](#).
i **NOTE:** Before installing the full length expansion card risers, install the GPU air shroud.
4. [Install the air shroud](#) or [install the GPU air shroud](#).
5. [Install the cooling fan cage assembly](#).
6. [Install the air shroud top cover](#).
7. [Install the support bar](#).
8. Follow the procedure listed in [After working inside your system](#).

PEM power board

This is a service technician replaceable part only.

Removing the PEM power board

There are three PEM power boards on the system board. The procedure to remove is similar.

Prerequisites

1. Follow the safety guidelines listed in the [Safety instructions](#).
2. Follow the procedure listed in the [Before working inside your system](#).
3. [Remove the support bar](#).
4. [Remove the air shroud top cover](#).
5. [Remove the cooling fan cage assembly](#).

6. If installed, [remove the air shroud](#) or [remove the GPU air shroud](#).

i **NOTE:** The GPU air shroud can be removed only after the full length expansion card risers have been removed.

7. If installed, [Remove the full length expansion card riser](#).

i **NOTE:** See [cable routing](#) section for more information.

8. Disconnect the UPI and riser cables from the PEM.

9. [Remove the PEM](#).

Steps

1. Using a flat blade screwdriver remove the PEM power board cover.

2. Holding the PEM power board by its edges lift the power board from the connector on the system board.

i **NOTE:** The numbers on the image do not depict the exact steps. The numbers are for representation of sequence.

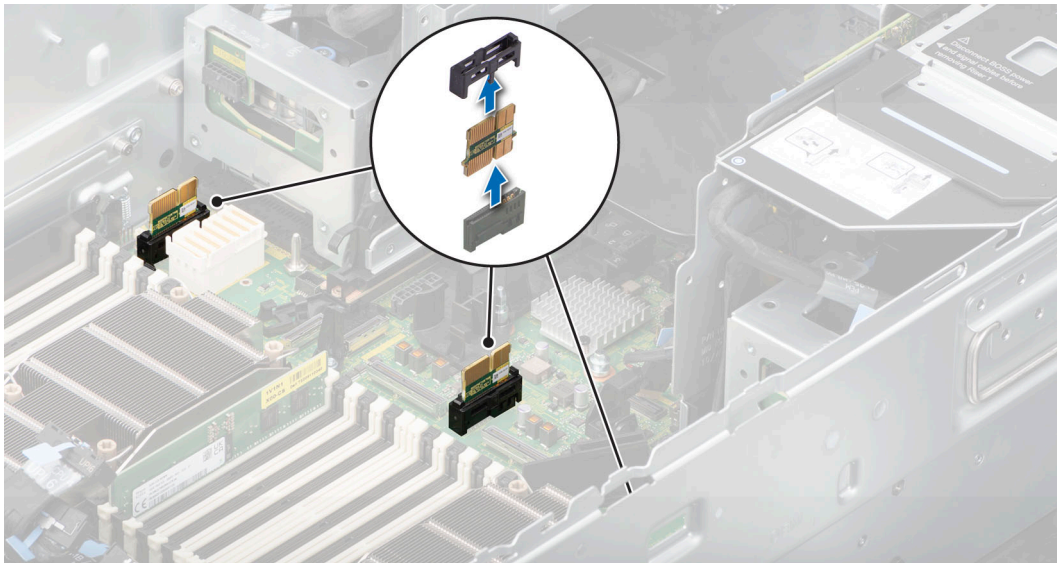

Figure 151. Removing the PEM power board

Next steps

1. [Replace the power distribution board](#).

Installing the PEM power board

Prerequisites

1. Follow the safety guidelines listed in the [Safety instructions](#).
2. Follow the procedure listed in the [Before working inside your system](#).
3. [Remove the support bar](#).
4. [Remove the air shroud top cover](#).
5. [Remove the cooling fan cage assembly](#).
6. If installed, [remove the air shroud](#) or [remove the GPU air shroud](#).

i **NOTE:** The GPU air shroud can be removed only after the full length expansion card risers have been removed.

7. If installed, [Remove the full length expansion card riser](#).

i **NOTE:** See [cable routing](#) section for more information.

8. Disconnect the UPI and riser cables from the PEM.

9. [Remove the PEM](#).

Steps

1. Align and lower the PEM power board into the system board connector.
2. Press the power board until seated firmly.
3. Insert the PEM power board cover.

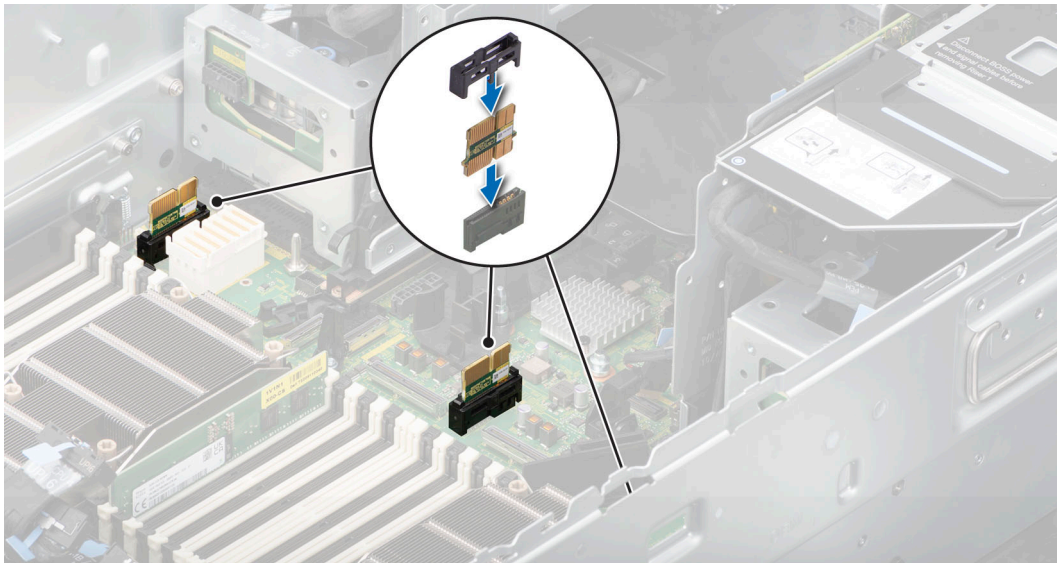

Figure 152. Installing the PEM power board

Next steps

1. [Install the PEM.](#)
2. Connect the UPI and riser cables to the PEM.
3. If removed, [install the full length expansion card riser.](#)
NOTE: Before installing the full length expansion card risers, install the GPU air shroud.
4. [Install the air shroud or install the GPU air shroud.](#)
5. [Install the cooling fan cage assembly.](#)
6. [Install the air shroud top cover.](#)
7. [Install the support bar.](#)
8. Follow the procedure listed in [After working inside your system.](#)

Optional BOSS-N1 module

Removing the BOSS-N1 module blank

Prerequisites

1. Follow the safety guidelines listed in the [Safety instructions.](#)
2. Follow the procedure listed in [Before working inside your system.](#)

Steps

Use a screwdriver to push out the blank from the BOSS-N1 module bay.

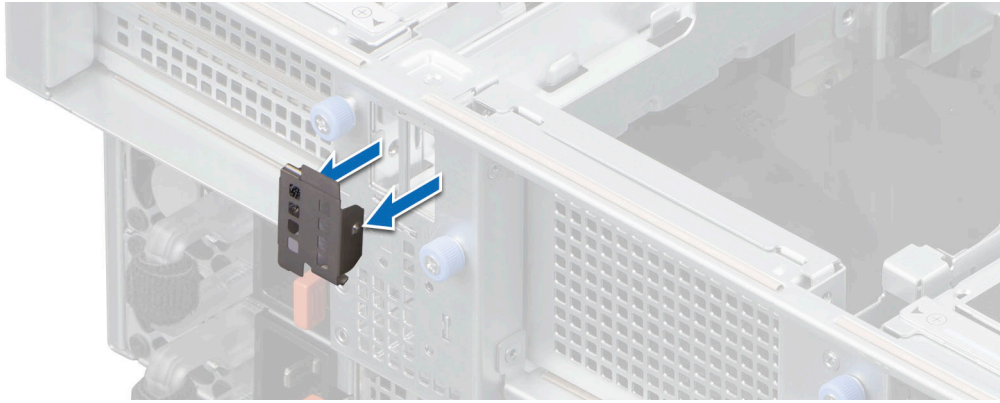

Figure 153. Removing the BOSS-N1 module blank

Next steps

1. [Replace the BOSS-N1 module blank or install BOSS-N1 module.](#)

Installing the BOSS-N1 module blank

Prerequisites

Follow the safety guidelines listed in the [Safety instructions](#).

Steps

Align the blank with the BOSS-N1 module bay and push it into the bay until it clicks into place.

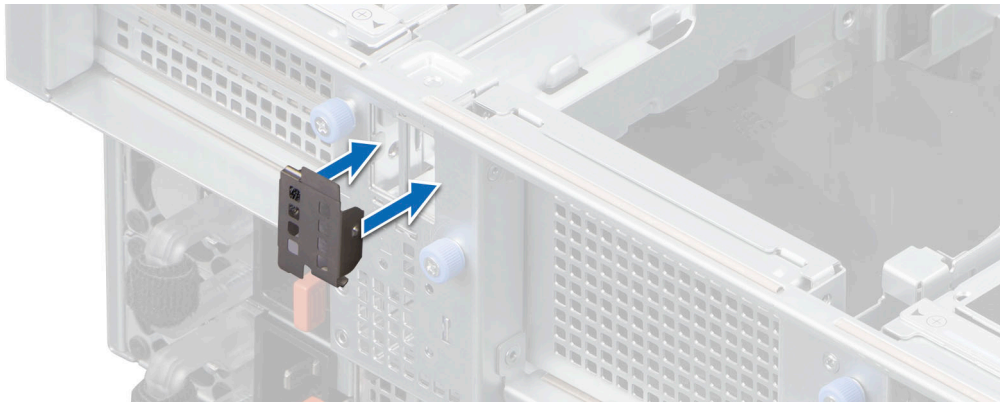

Figure 154. Installing the BOSS-N1 module blank

Next steps

1. Follow the procedure listed in [After working inside your system](#).

Removing the BOSS-N1 card carrier blank

Prerequisites

1. Follow the safety guidelines listed in the [Safety instructions](#).
2. Follow the procedure listed in [Before working inside your system](#).

Steps

Press and pull the BOSS-N1 card carrier blank out from the BOSS-N1 module.

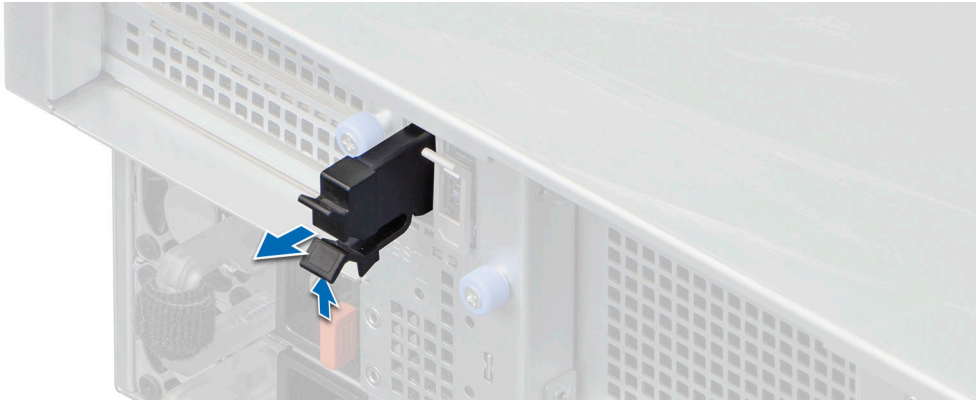

Figure 155. Removing the BOSS-N1 card carrier blank

Next steps

1. [Replace the BOSS-N1 card carrier blank](#) or install BOSS-N1 card carrier.

Installing the BOSS-N1 card carrier blank

Prerequisites

1. Follow the safety guidelines listed in the [Safety instructions](#).

Steps

Align the blank with the BOSS-N1 module bay and push it into the bay until it clicks into place.

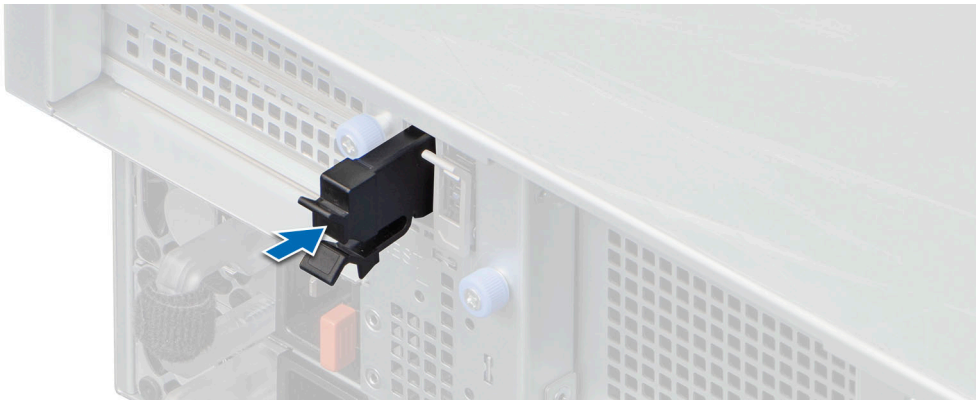

Figure 156. Installing the BOSS-N1 card carrier blank

Removing the BOSS-N1 module

Prerequisites

1. Follow the safety guidelines listed in the [Safety instructions](#).
2. Follow the procedure listed in the [Before working inside your system](#).
3. If required, [Remove the support bar](#).
4. If required, [Remove the air shroud top cover](#).
5. If required, [Remove the cooling fan cage assembly](#).

6. If required, [Remove the air shroud](#).

Steps

1. Pull and lift the BOSS-N1 card carrier retention latch lock to open.
2. Slide the BOSS-N1 card carrier out.

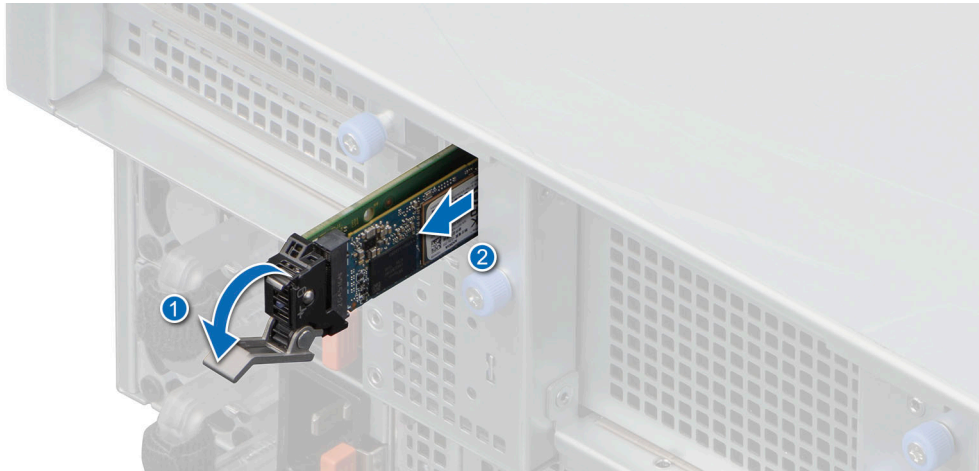

Figure 157. Removing the BOSS-N1 card carrier

3. Using the Phillips #1 screwdriver remove the M3 x 0.5 x 4.5 mm screw that secures the M.2 NVMe SSD to the BOSS-N1 card carrier.
4. Slide the M.2 NVMe SSD out from the BOSS-N1 card carrier.

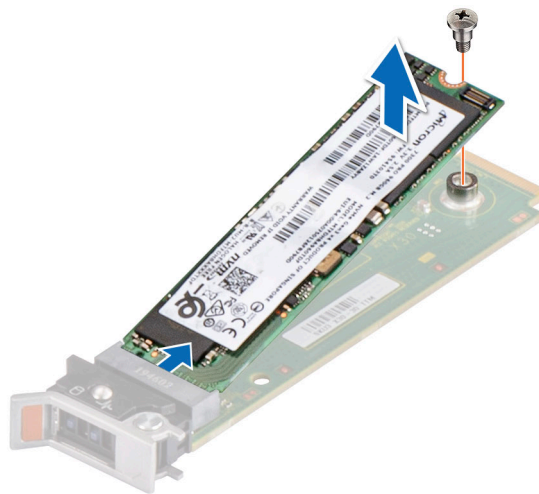

Figure 158. Removing the M.2 NVMe SSD

5. Disconnect the BOSS-N1 power and signal cable from the system board.
6. Using the Phillips #1 screwdriver remove the M3 x 0.5 x 4.5 mm screw that secures the BOSS-N1 module on Riser 1.
7. Slide the BOSS-N1 module towards the front of the chassis and lift the module.

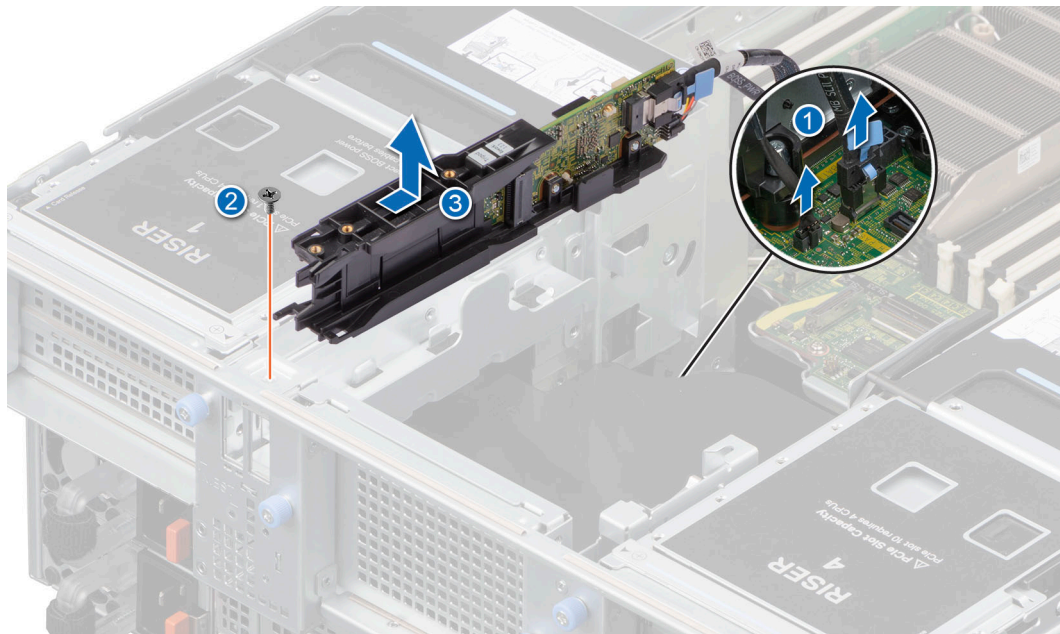

Figure 159. Removing the BOSS-N1 module

8. Pull the blue tag to remove the BOSS-N1 signal cable from the BOSS-N1 module.
9. Remove the BOSS-N1 power cable from the BOSS-N1 module.

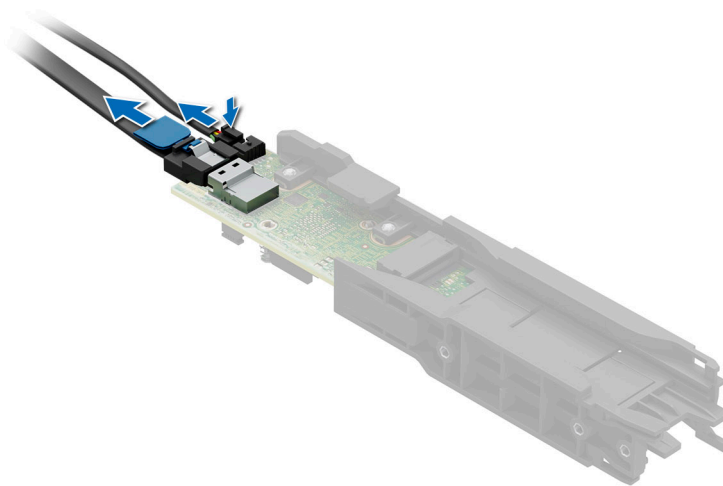

Figure 160. Removing the BOSS-N1 power and signal cable from the BOSS-N1 module

Next steps

1. [Replace the BOSS-N1 module](#) or [Install the BOSS-N1 module blank](#).

Installing the BOSS-N1 module

Prerequisites

1. Follow the safety guidelines listed in the [Safety instructions](#).
2. Follow the procedure listed in the [Before working inside your system](#).
3. If required, [Remove the support bar](#).
4. If required, [Remove the air shroud top cover](#).

5. If required, Remove the cooling fan cage assembly.
6. If required, Remove the air shroud.
7. If installed, remove the BOSS module blank.

Steps

1. Connect the BOSS-N1 power and signal cables to the connectors on the BOSS-N1 module.

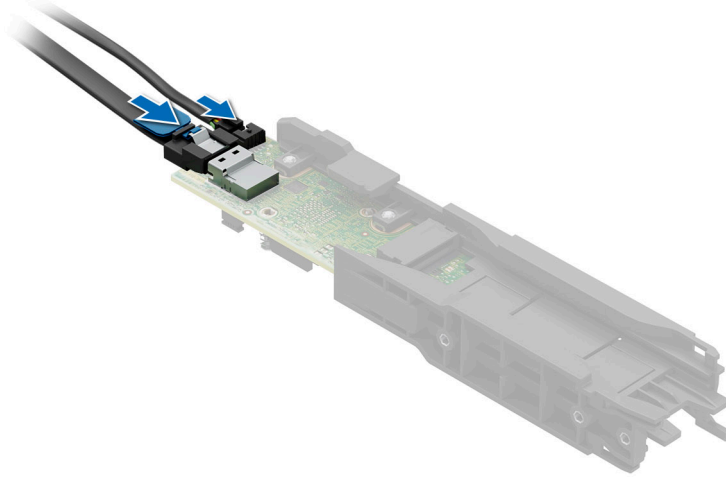

Figure 161. Connecting the BOSS-N1 power and signal cables to the BOSS-N1 module

2. Align the BOSS-N1 module at an angle with the controller card module slot.
3. Insert the BOSS-N1 module and push the module horizontally towards the rear of the system until firmly seated.
4. Using the Phillips #1 screwdriver, secure the BOSS-N1 module with the M3 x 0.5 x 4.5 mm screw.
5. Connect the BOSS-N1 power and signal cable to the connectors on the system board.

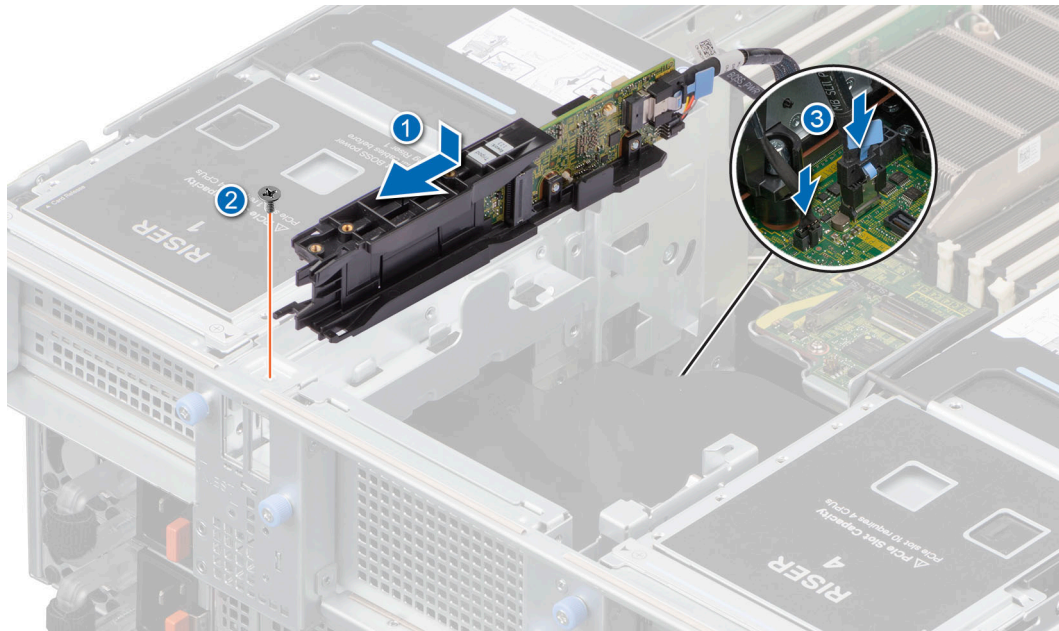

Figure 162. Installing the BOSS-N1 module

6. Align the M.2 NVMe SSD at an angle with the BOSS-N1 card carrier.
7. Insert the M.2 NVMe SSD until it is firmly seated in the BOSS-N1 card carrier.
8. Using the Phillips #1 screwdriver, secure the M.2 NVMe SSD on the BOSS-N1 card carrier with the M3 x 0.5 x 4.5 mm screw.

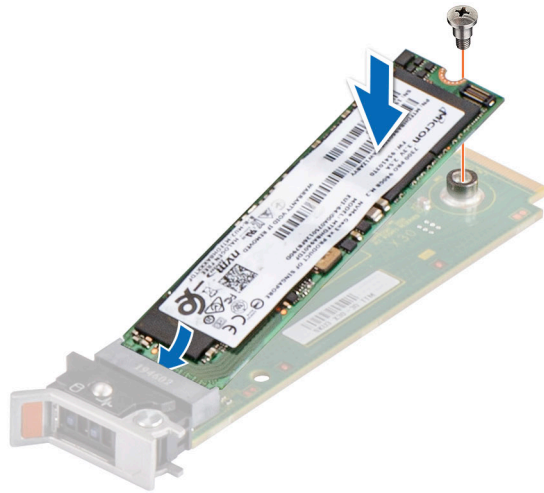

Figure 163. Installing the M.2 NVMe SSD

9. Slide the BOSS-N1 card carrier into the BOSS-N1 module slot.
10. Close the BOSS-N1 card carrier release latch to lock the carrier in place.

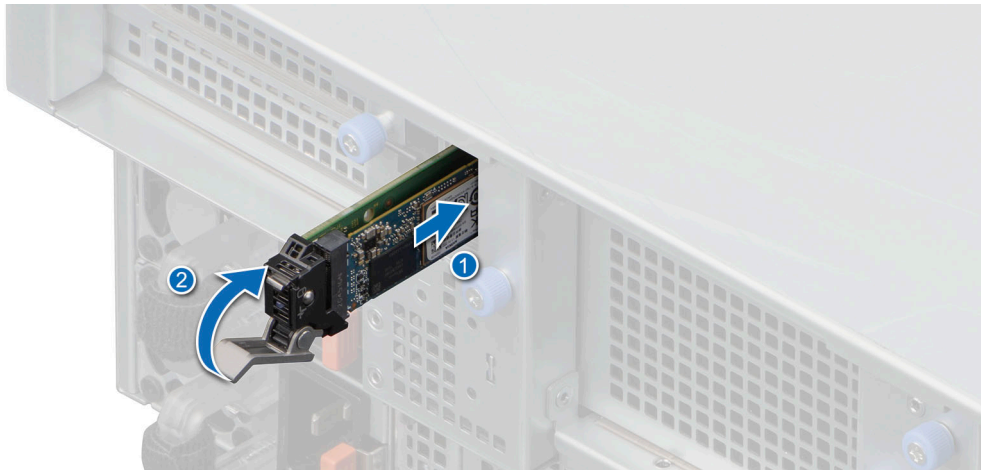

Figure 164. Installing the BOSS-N1 card carrier

Next steps

1. If removed, [install the air shroud](#)
2. [Install the cooling fan cage assembly.](#)
3. [Install the air shroud top cover.](#)
4. [Install the support bar.](#)
5. Follow the procedure listed in the [After working inside your system.](#)

System battery

This is a service technician replaceable part only.

Replacing the system battery

Prerequisites

⚠️ WARNING: There is a danger of a new battery exploding if it is incorrectly installed. Replace the battery only with the same or equivalent type that is recommended by the manufacturer. Discard used batteries according to the manufacturer's instructions. See the Safety instructions that came with your system for more information.

1. Follow the safety guidelines listed in the [Safety instructions](#).
2. Follow the procedure listed in the [Before working inside your system](#).
3. If applicable, disconnect the power or data cables from the expansion cards.
4. [Remove the cooling fan cage assembly](#).

Steps

1. To remove the battery:
 - a. Use a plastic scribe to pry out the system battery.

⚠️ CAUTION: To avoid damage to the battery connector, you must firmly support the connector while installing or removing a battery.

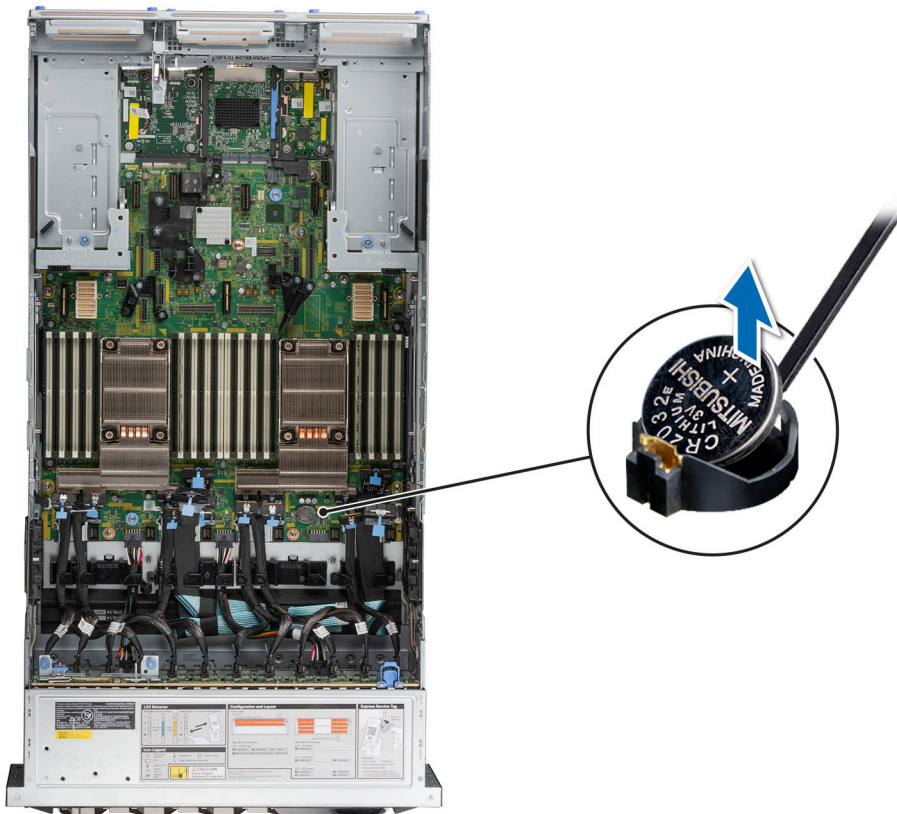

Figure 165. Removing the system battery

2. To install a new system battery:
 - a. Hold the battery with the positive side facing up and slide it under the securing tabs.
 - b. Press the battery into the connector until it snaps into place.

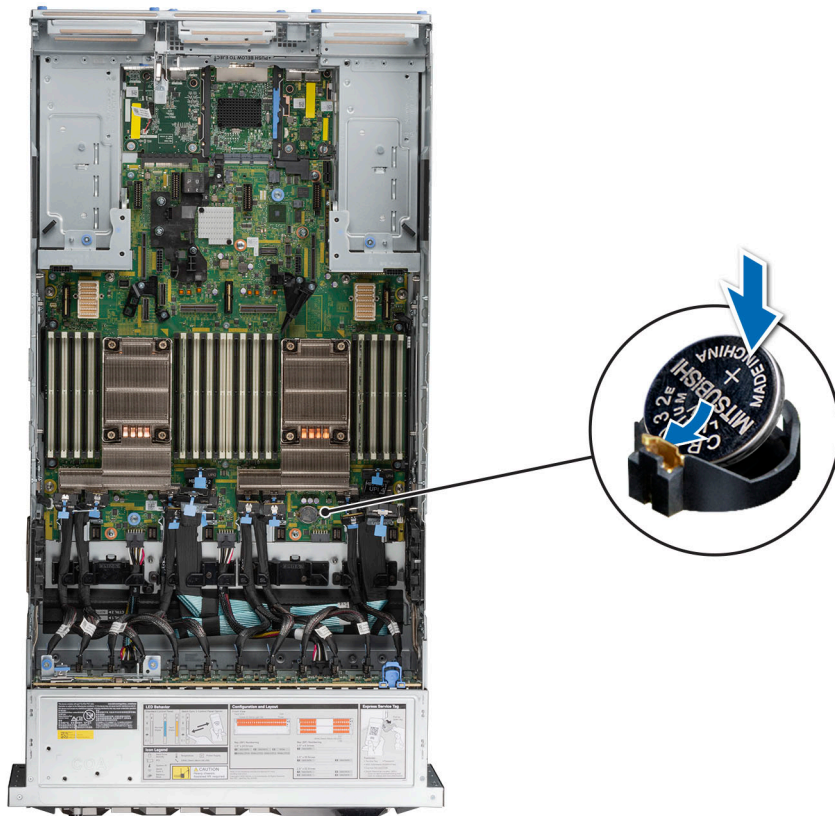

Figure 166. Installing the system battery

Next steps

1. [Install the cooling fan cage assembly.](#)
2. Follow the procedure listed in [After working inside your system.](#)
3. Confirm that the battery is operating properly, by performing the following steps:
 - a. Enter the System Setup, while booting, by pressing F2.
 - b. Enter the correct time and date in the System Setup **Time** and **Date** fields.
 - c. **Exit** the System Setup.
 - d. To test the newly installed battery, check the time and date at least an hour after installing the battery.
 - e. Enter the System Setup and if the time and date are still incorrect, see [Getting help](#) section.

Optional internal USB card

NOTE: To locate the internal USB port on the system board, see the [System board jumpers and connectors](#) section.

Removing the internal USB card

Prerequisites

CAUTION: To avoid interference with other components in the server, the maximum permissible dimensions of the USB memory key are 15.9 mm wide x 57.15 mm long x 7.9 mm high.

1. Follow the safety guidelines listed in the [Safety instructions.](#)
2. Follow the procedure listed in the [Before working inside your system.](#)
3. [Remove the support bar.](#)
4. [Remove the air shroud top cover.](#)
5. [Remove the cooling fan cage assembly.](#)

6. Remove the air shroud.
7. Remove the expansion card risers or remove the full length expansion card riser.
 - i** **NOTE:** See [cable routing](#) section for more information.
8. Remove the riser air shroud.
9. If required, remove the PEM.

Steps

1. Holding the blue tag, lift the internal USB card to disconnect from the connector on the system board.
2. Remove the USB memory key from the internal USB card.

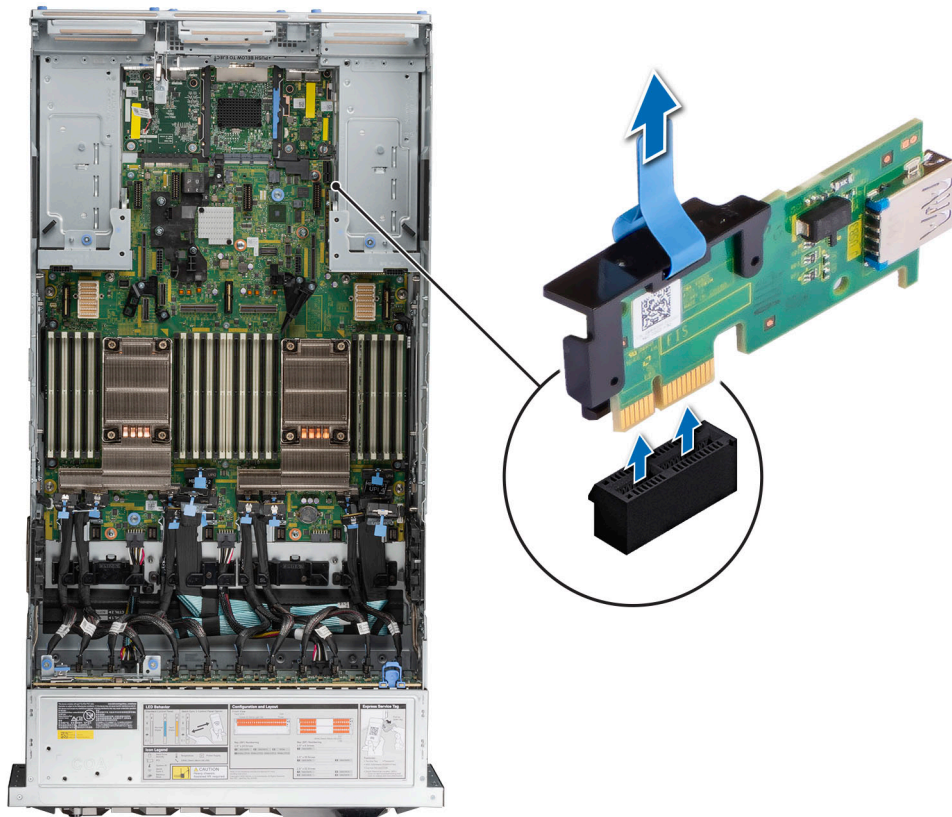

Figure 167. Removing the internal USB card

Next steps

1. [Replace the internal USB card.](#)

Installing the internal USB card

Prerequisites

1. Follow the safety guidelines listed in the [Safety instructions](#).
2. Follow the procedure listed in the [Before working inside your system](#).
3. [Remove the support bar.](#)
4. [Remove the air shroud top cover.](#)
5. [Remove the cooling fan cage assembly.](#)
6. [Remove the air shroud.](#)
7. [Remove the expansion card risers](#) or [remove the full length expansion card riser](#).
 - i** **NOTE:** See [cable routing](#) section for more information.
8. [Remove the riser air shroud.](#)

9. If required, [remove the PEM](#).

Steps

1. Connect the USB key to the internal USB card.

i **NOTE:** For information about the exact location of USB on system board, see [System board jumpers and connectors](#) section.

2. Align the internal USB card with the connector on the system board and press firmly until the internal USB card is seated.

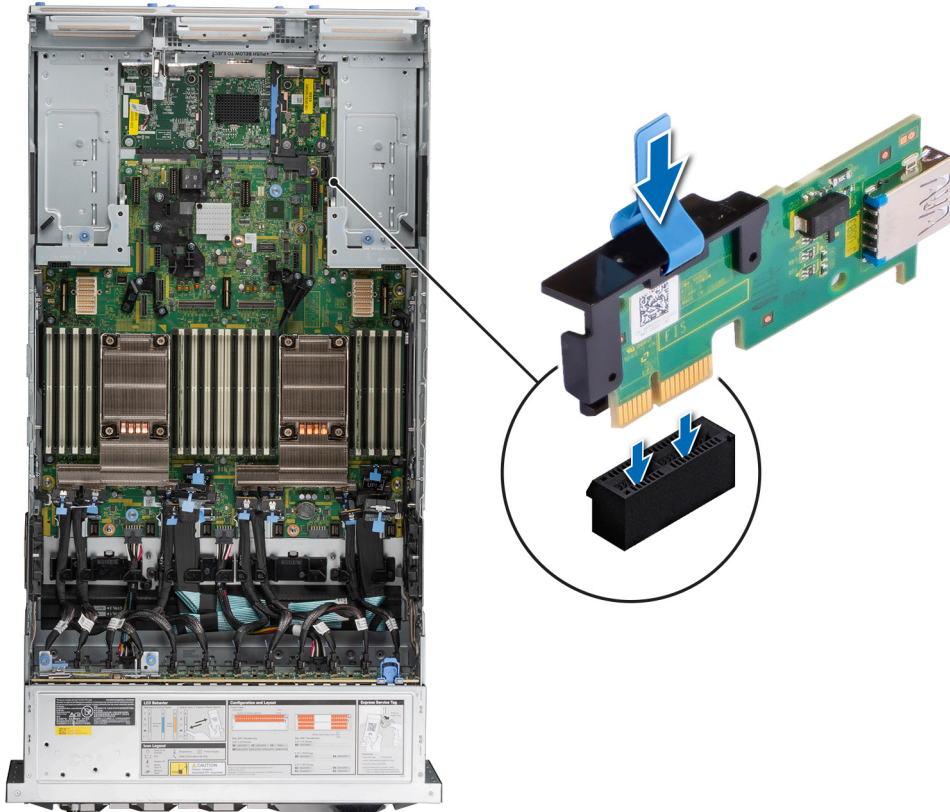

Figure 168. Installing the internal USB card

Next steps

1. If removed, [install the PEM](#).
2. [Install the riser air shroud](#).
3. [Install the expansion card risers](#) or [Install the full length expansion card riser](#).
4. [Install the air shroud](#)
5. [Install the cooling fan cage assembly](#).
6. [Install the air shroud top cover](#).
7. [Install the support bar](#).
8. Follow the procedure listed in [After working inside your system](#).
9. While booting, press F2 to enter **System Setup** and verify that the system detects the USB memory key.

Intrusion switch

This is a service technician replaceable part only.

Removing the intrusion switch module

Prerequisites

1. Follow the safety guidelines listed in the [Safety instructions](#).
2. Follow the procedure listed in the [Before working inside your system](#).
3. [Remove the support bar](#).
4. [Remove the air shroud top cover](#).
5. [Remove the cooling fan cage assembly](#).
6. [Remove the air shroud](#).
7. [Remove the expansion card risers](#) or [remove the full length expansion card riser](#).

i **NOTE:** See [cable routing](#) section for more information.

8. [Remove the riser air shroud](#).
9. If required, [remove the PEM](#).

i **NOTE:** Ensure that you note the routing of the cable as you remove it from the system board. Route the cable properly when you replace it to prevent the cable from being pinched or crimped.

Steps

1. Disconnect the intrusion switch cable from the connector on the rear I/O board.

i **NOTE:** Remove the intrusion switch cable from the cable clip.

2. Using a Phillips #1 screwdriver, loosen the screw on the intrusion switch module.
3. Lift the intrusion switch module out of the slot on the system.

i **NOTE:** The numbers on the image do not depict the exact steps. The numbers are for representation of sequence.

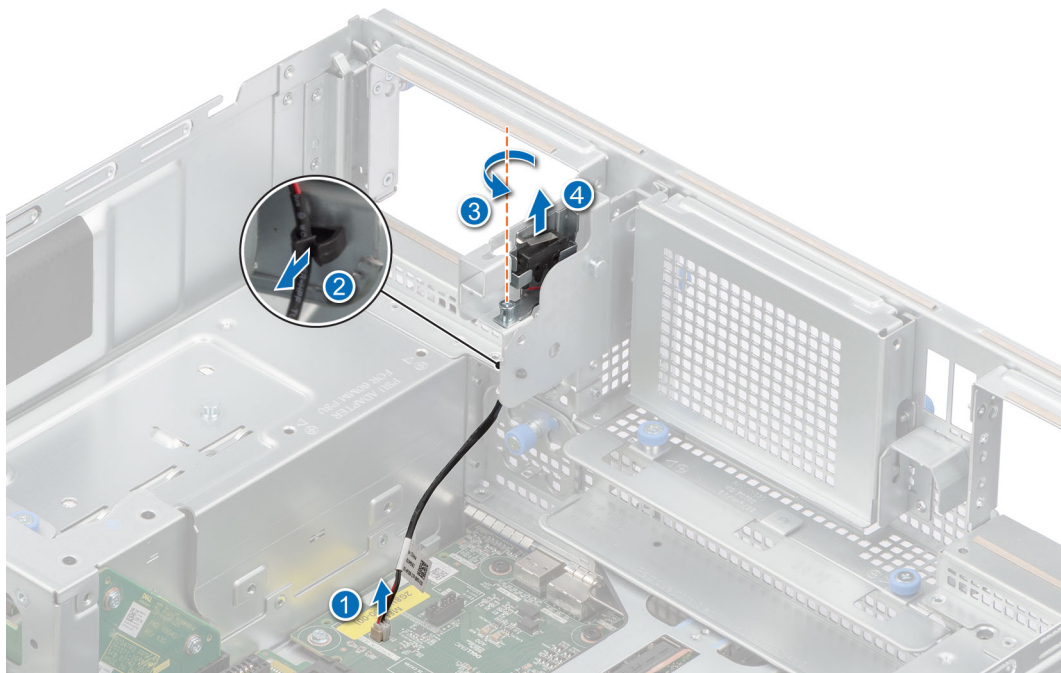

Figure 169. Removing the intrusion switch module

Next steps

1. [Replace the intrusion switch module.](#)

Installing the intrusion switch module

Prerequisites

1. Follow the safety guidelines listed in the [Safety instructions](#).
2. Follow the procedure listed in the [Before working inside your system](#).
3. [Remove the support bar.](#)
4. [Remove the air shroud top cover.](#)
5. [Remove the cooling fan cage assembly.](#)
6. [Remove the air shroud.](#)
7. [Remove the expansion card risers or remove the full length expansion card riser.](#)

i **NOTE:** See [cable routing](#) section for more information.

8. [Remove the riser air shroud.](#)
9. If required, [remove the PEM.](#)

i **NOTE:** Ensure that you note the routing of the cable as you remove it from the system board. Route the cable properly when you replace it to prevent the cable from being pinched or crimped.

Steps

1. Align and lower the intrusion switch module into the slot in the system until firmly seated.
2. Using a Phillips #1 screwdriver, tighten the screw on the intrusion switch module.

i **NOTE:** Secure the intrusion switch cable to the cable clip.

3. Connect the intrusion switch cable to the connector on the rear I/O board.

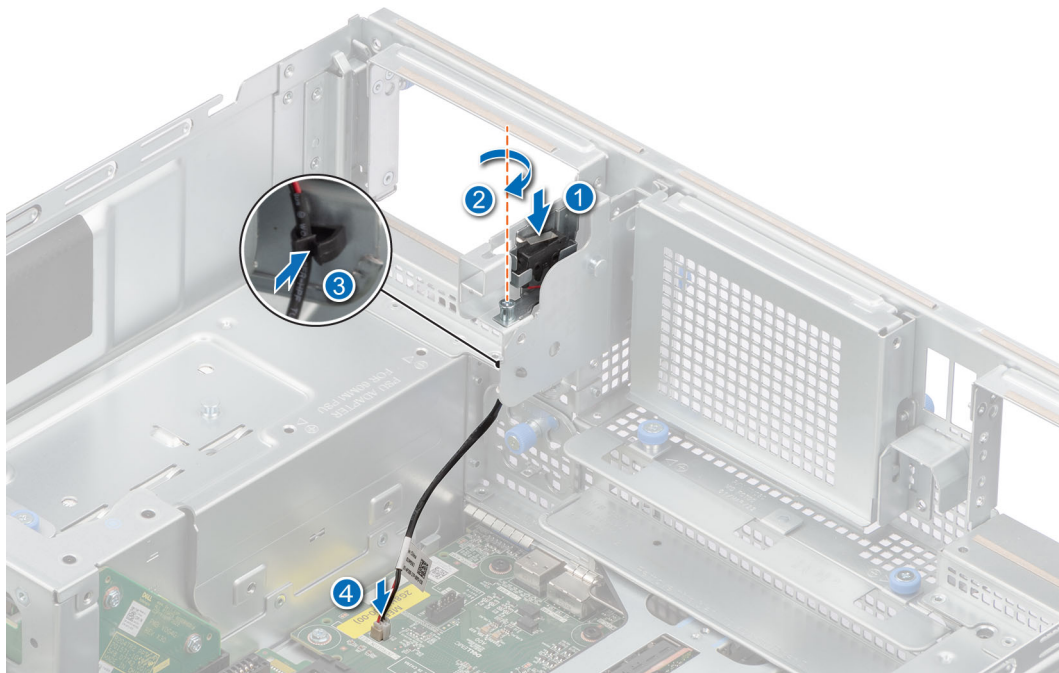

Figure 170. Installing the intrusion switch module

Next steps

1. If removed, [install the PEM.](#)
2. [Install the riser air shroud.](#)

3. Install the expansion card risers or Install the full length expansion card riser.
4. Install the air shroud
5. Install the cooling fan cage assembly.
6. Install the air shroud top cover.
7. Install the support bar.
8. Follow the procedure listed in [After working inside your system](#).

Optional OCP card

Removing the OCP card

Prerequisites

1. Follow the safety guidelines listed in the [Safety instructions](#).
2. Follow the procedure listed in the [Before working inside your system](#).
3. Remove the support bar.
4. Remove the air shroud top cover.
5. Remove the cooling fan cage assembly.
6. Remove the air shroud.
7. Remove the expansion card risers or remove the full length expansion card riser.
i **NOTE:** See [cable routing](#) section for more information.
8. Remove the riser air shroud.
9. If required, remove the PEM.

Steps

1. Open the blue latch to disengage the OCP card.
2. Push the OCP card towards the rear end of the system to disconnect from the connector on the system board.
3. Slide the OCP card out of the slot on the system.

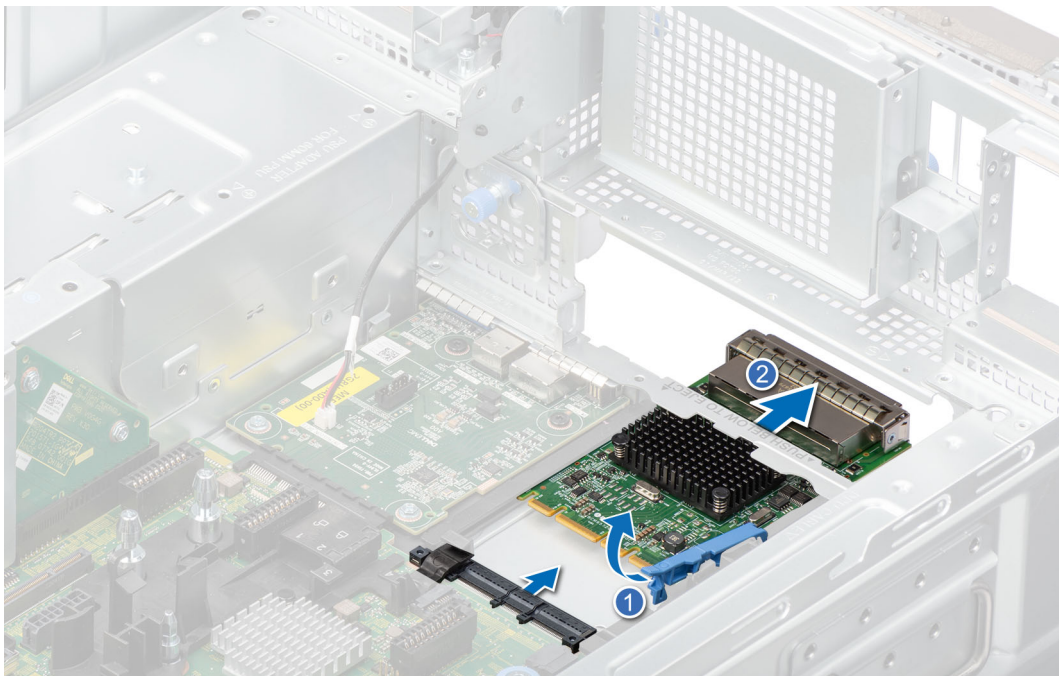

Figure 171. Removing the OCP card

4. If the OCP card is not going to be replaced, install a filler bracket .

NOTE: You must install a filler bracket over an empty expansion card slot to maintain Federal Communications Commission (FCC) certification of the system. The brackets also keep dust and dirt out of the system and aid in proper cooling and airflow inside the system.

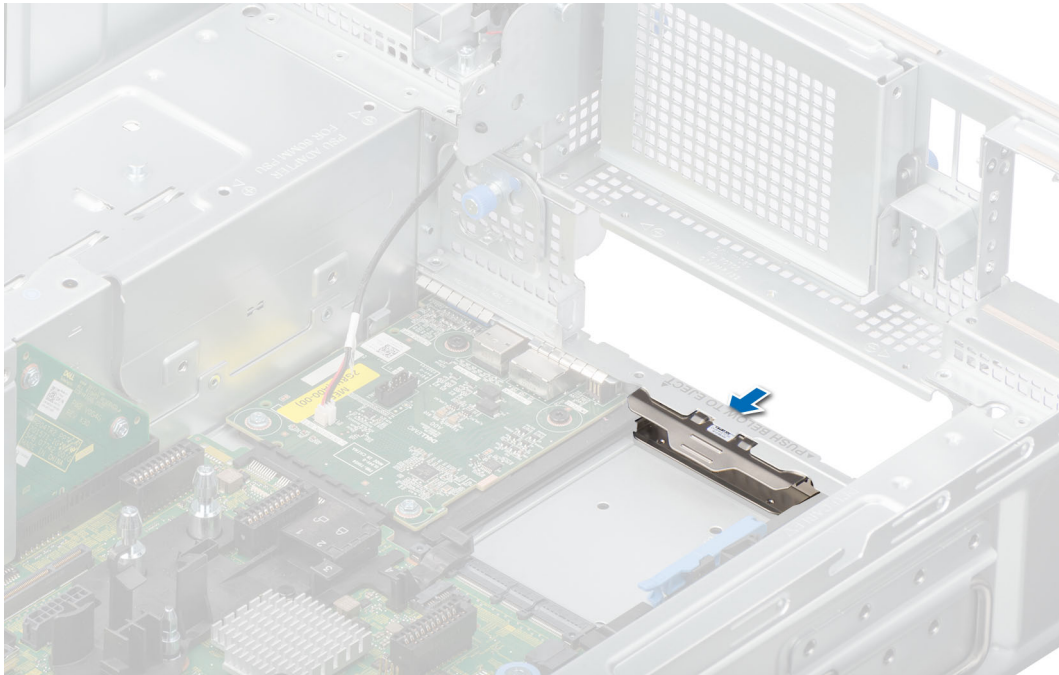

Figure 172. Installation of filler bracket

Next steps

1. Replace the OCP card.

Installing the OCP card

Prerequisites

1. Follow the safety guidelines listed in the [Safety instructions](#).
2. Follow the procedure listed in the [Before working inside your system](#).
3. [Remove the support bar](#).
4. [Remove the air shroud top cover](#).
5. [Remove the cooling fan cage assembly](#).
6. [Remove the air shroud](#).
7. [Remove the expansion card risers](#) or [remove the full length expansion card riser](#).

NOTE: See [cable routing](#) section for more information.

8. [Remove the riser air shroud](#).
9. If required, [remove the PEM](#).

CAUTION: Do not install GPUs, network cards, or other PCIe devices on your system that are not validated and tested by Dell. Damage caused by unauthorized and invalidated hardware installation will null and void the system warranty.

Steps

1. If installed, remove the filler bracket.

NOTE: Store the filler bracket for future use. Filler brackets must be installed in empty expansion card slots to maintain Federal Communications Commission (FCC) certification of the system. The brackets also keep dust and dirt out of the system and aid in proper cooling and airflow inside the system.

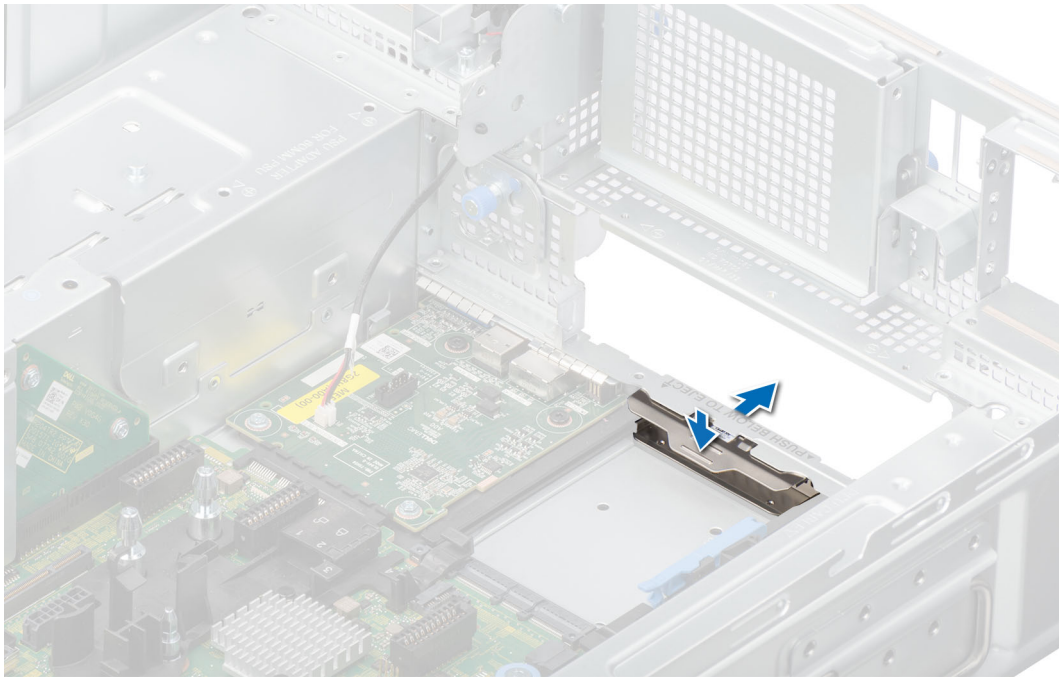

Figure 173. Removal of filler bracket

2. Open the blue latch on the system board.
3. Slide the OCP card into the slot in the system.
4. Push until the OCP card is connected to the connector on the system board.
5. Close the blue latch to lock the OCP card to the system.

NOTE: The numbers on the image do not depict the exact steps. The numbers are for representation of sequence.

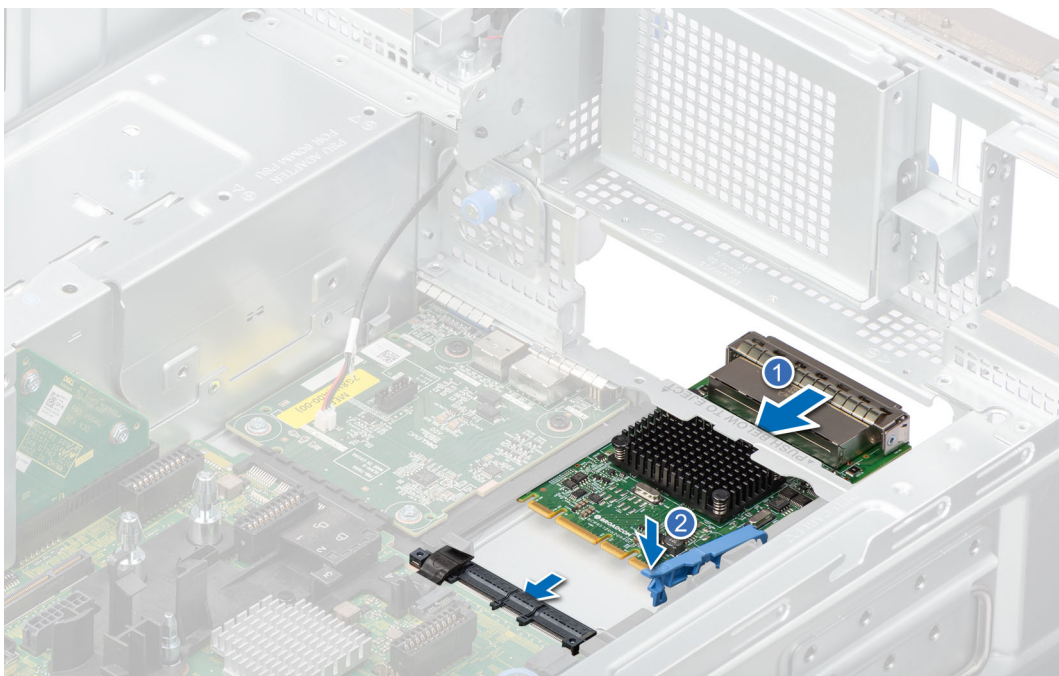

Figure 174. Installing the OCP card

Next steps

1. If removed, [install the PEM](#).
2. [Install the riser air shroud](#).
3. [Install the expansion card risers](#) or [Install the full length expansion card riser](#).
4. [Install the air shroud](#)
5. [Install the cooling fan cage assembly](#).
6. [Install the air shroud top cover](#).
7. [Install the support bar](#).
8. Follow the procedure listed in [After working inside your system](#).

Power supply unit

NOTE: While replacing the hot swappable PSU, after next server boot; the new PSU automatically updates to the same firmware and configuration of the replaced one. For updating to the latest firmware and changing the configuration, see the *Lifecycle Controller User's Guide* at <https://www.dell.com/idracmanuals>.

Hot spare feature

Your system supports the hot spare feature that significantly reduces the power overhead associated with the power supply unit (PSU) redundancy.

When the hot spare feature is enabled, one of the redundant PSUs is switched to the sleep state. The active PSU supports 100 percent of the system load, thus operating at higher efficiency. The PSU in the sleep state monitors output voltage of the active PSU. If the output voltage of the active PSU drops, the PSU in the sleep state returns to an active output state.

If having both PSUs active is more efficient than having one PSU in the sleep state, the active PSU can also activate the sleeping PSU.

The default PSU settings are as follows:

- If the load on the active PSU is more than 50 percent of PSU rated power wattage, then the redundant PSU is switched to the active state.
- If the load on the active PSU falls below 20 percent of PSU rated power wattage, then the redundant PSU is switched to the sleep state.

You can configure the hot spare feature by using the iDRAC settings. For more information, see the *iDRAC User's Guide* available at www.dell.com/poweredgemanuals.

Removing a power supply unit blank

Prerequisites

Follow the safety guidelines listed in the [Safety instructions](#).

Steps

Pull the blank out of the system.

CAUTION: To ensure proper system cooling, the PSU blank must be installed in the empty PSU bay in a non-redundant configuration. Remove the PSU blank only if you are installing a PSU.

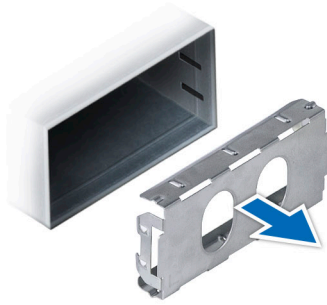

Figure 175. Removing a power supply unit blank

Next steps

1. Replace the PSU blank or install the PSU.

Installing a power supply unit blank

Prerequisites

1. Follow the safety guidelines listed in the [Safety instructions](#).
2. If required, [Remove the PSU](#).

Steps

Align the PSU blank with the PSU bay and push it into the PSU bay until it clicks into place.

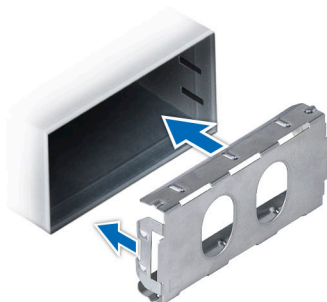

Figure 176. Installing a power supply unit blank

Removing a power supply unit adapter

Remove the PSU adapter, when installing PSU with 86 mm wide form factor.

Prerequisites

1. Follow the safety guidelines listed in the [Safety instructions](#).
2. Follow the procedure listed in [Before working inside your system](#).
3. [Remove the support bar](#).
4. [Remove the air shroud top cover](#).
5. [Remove the cooling fan cage assembly](#).
6. [Remove the air shroud](#) or [remove the GPU air shroud](#).
i **NOTE:** The GPU air shroud can be removed only after the full length expansion card risers have been removed.
7. [Remove the expansion card risers](#) or [remove the full length expansion card riser](#).

NOTE: See [cable routing](#) section for more information.

8. Remove the riser air shroud.
9. Remove the PSU.

Steps

Using a Phillips #1 screwdriver, loosen the screws and remove the power supply unit adapter.

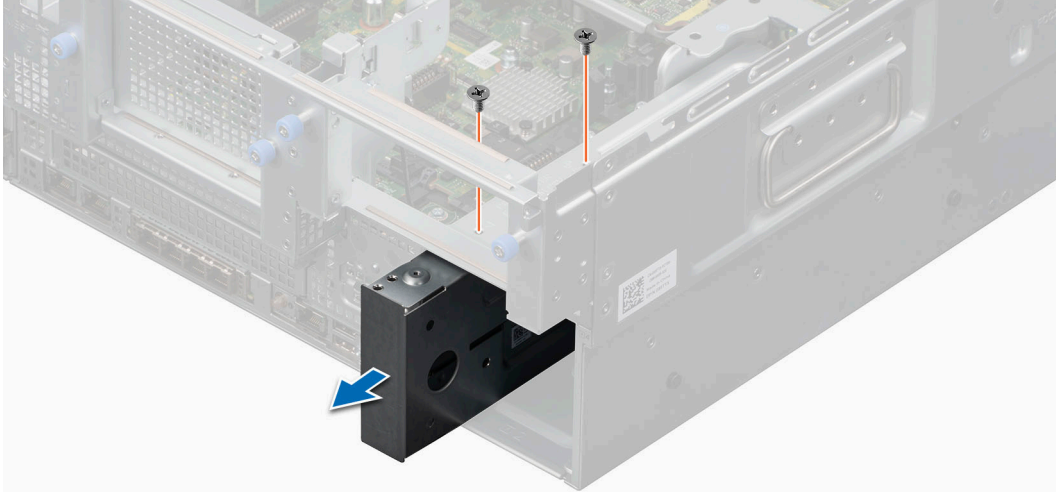

Figure 177. Removing a power supply unit adapter

Next steps

1. Replace the PSU adapter or Install the PSU.

Installing a power supply unit adapter

Prerequisites

1. Follow the safety guidelines listed in the [Safety instructions](#).
2. Follow the procedure listed in [Before working inside your system](#).
3. Remove the support bar.
4. Remove the air shroud top cover.
5. Remove the cooling fan cage assembly.
6. Remove the air shroud or remove the GPU air shroud.
 - NOTE:** The GPU air shroud can be removed only after the full length expansion card risers have been removed.
7. Remove the expansion card risers or remove the full length expansion card riser.
 - NOTE:** See [cable routing](#) section for more information.
8. Remove the riser air shroud.
9. Remove the PSU.

NOTE: Remove the PSU adapter, when installing PSU with 86 mm wide form factor.

Steps

1. Align and insert the power supply unit adapter.
2. Using a phillips #1 screwdriver, tighten the screws.

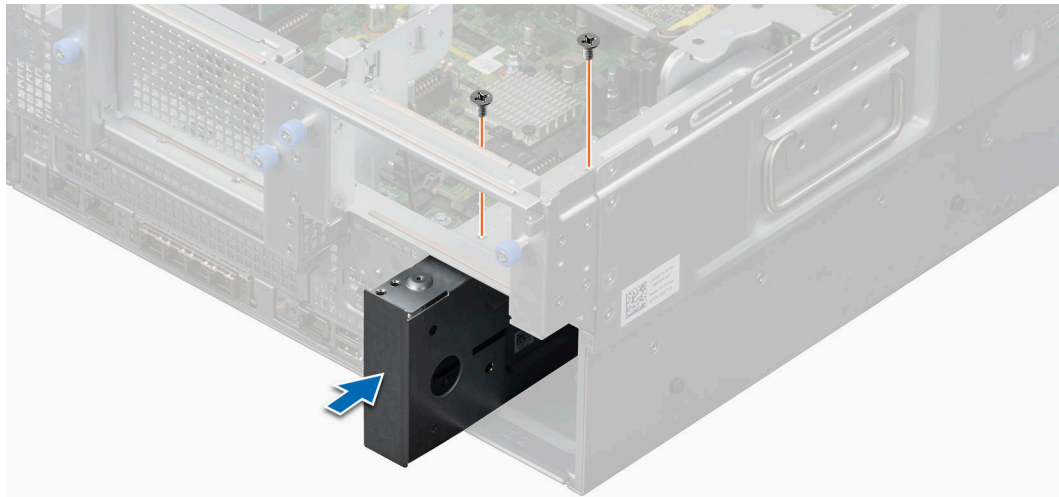

Figure 178. Installing a power supply unit adapter

Next steps

1. Install the expansion card risers or [Install the full length expansion card riser](#).
i **NOTE:** Before installing the full length expansion card risers, install the GPU air shroud.
2. [Install the air shroud](#) or [install the GPU air shroud](#)
3. [Install the cooling fan cage assembly](#).
4. [Install the air shroud top cover](#).
5. [Install the support bar](#).
6. [Install the PSU](#).
7. Follow the procedure listed in [After working inside your system](#).

Removing a power supply unit

Prerequisites

⚠ CAUTION: The system requires one power supply unit (PSU) for normal operation. On power-redundant systems, remove and replace only one PSU at a time in a system that is powered on.

1. Follow the safety guidelines listed in the [Safety instructions](#).
2. Disconnect the power cable from the power outlet and from the PSU that you intend to remove.
3. Remove the cable from the strap on the PSU handle.
4. Unlatch and lift or remove the optional cable management accessory if it interferes with the PSU removal.
i **NOTE:** For information about the cable management when the PSU is removed or installed while the system is in a rack, see the system's cable management arm documentation at <https://www.dell.com/poweredgemanuals>.

Steps

Press the release latch and holding the PSU handle, slide the PSU out of the bay.

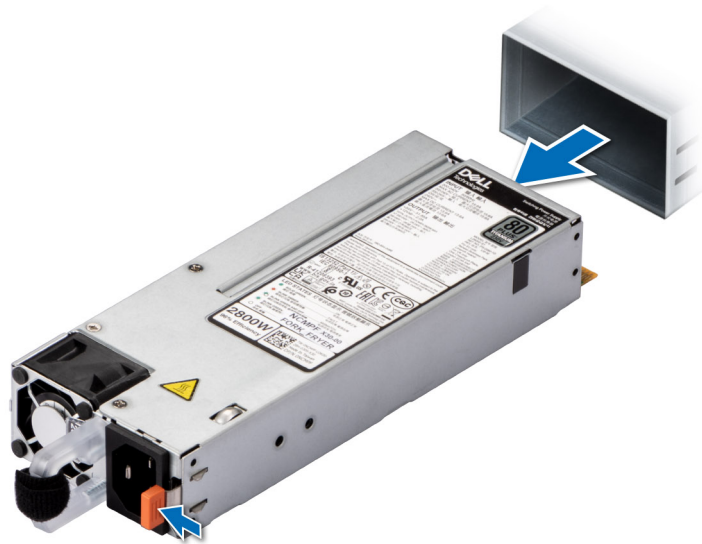

Figure 179. Removing a power supply unit

Next steps

1. [Replace the PSU](#) or [install the PSU blank](#).

Installing a power supply unit

Prerequisites

1. Follow the safety guidelines listed in the [Safety instructions](#).
2. For systems that supports redundant PSU, ensure that both the PSUs are of the same type and have the same maximum output power.
 - i** **NOTE:** The maximum output power (shown in watts) is listed on the PSU label.
3. If required, [Remove the PSU blank](#).

Steps

Slide the PSU into the PSU bay until the release latch snaps into place.



Figure 180. Installing a power supply unit

Next steps

1. If you have unlatched or removed the cable management accessory, reinstall or relatch it. For information about the cable management when the PSU is removed or installed while the system is in the rack, see the system's cable management accessory documentation at <https://www.dell.com/poweredgemanuals>.
2. Connect the power cable to the PSU, and plug the cable into a power outlet.

CAUTION: When connecting the power cable to the PSU, secure the cable to the PSU with the strap.

NOTE: When installing hot swapping, or hot adding a new PSU, wait for 15 s for the system to recognize the PSU and determine its status. The PSU redundancy may not occur until discovery is complete. The PSU status indicator turns green to indicate that the PSU is functioning properly.

Trusted Platform Module

This is a service technician replaceable part only.

Upgrading the Trusted Platform Module

Removing the TPM

Prerequisites

1. Follow the safety guidelines listed in the [Safety instructions](#).
2. Follow the procedure listed in [Before working inside your system](#).

NOTE:

- Ensure the operating system is compatible with the TPM version you are installing.
- Ensure that you download and install the latest BIOS firmware on your system.
- Ensure that the BIOS is configured to enable UEFI boot mode.

CAUTION: The TPM plug-in module is cryptographically bound to that particular system board after it is installed. When the system is powered on, any attempt to remove an installed TPM plug-in module breaks the cryptographic binding, and the removed TPM cannot be installed on another system board. Ensure any keys you have stored on the TPM have been securely transferred.

Steps

1. Locate the TPM connector on the system board. For more information, see [system board connectors](#) .
2. Press to hold the module down and remove the screw using the security Torx 8-bit shipped with the TPM module.
3. Slide the TPM module out from its connector.
4. Push the plastic rivet away from the TPM connector and rotate it 90° counterclockwise to release it from the system board.
5. Pull the plastic rivet out of its slot on the system board.

Installing the TPM

Prerequisites

1. Follow the safety guidelines listed in the [Safety instructions](#).
2. Follow the procedure listed in [Before working inside your system](#).

Steps

1. To install the TPM, align the edge connectors on the TPM with the slot on the TPM connector.
2. Insert the TPM into the TPM connector such that the plastic rivet aligns with the slot on the system board.
3. Press the plastic rivet until the rivet snaps into place.
4. Replace the screw that secures the TPM to the system board.

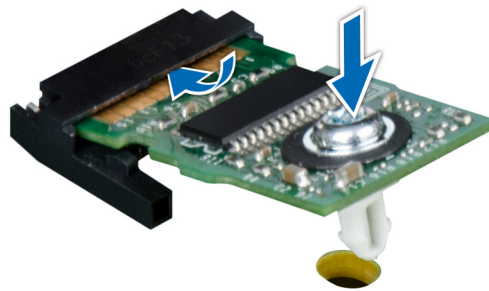

Figure 181. Installing the TPM

Initializing TPM for users

Steps

1. Initialize the TPM.
For more information, see [Initializing the TPM 2.0 for users](#).
2. The **TPM Status** changes to **Enabled, Activated**.

Initializing the TPM 2.0 for users

Steps

1. While booting your system, press F2 to enter System Setup.
2. On the **System Setup Main Menu** screen, click **System BIOS > System Security Settings**.
3. From the **TPM Security** option, select **On**.
4. Save the settings.
5. Restart your system.

System board

This is a service technician replaceable part only.

Removing the system board

Prerequisites

CAUTION: If you are using the Trusted Platform Module (TPM) with an encryption key, you may be prompted to create a recovery key during program or System Setup. Be sure to create and safely store this recovery key. If you replace this system board, you must supply the recovery key when you restart your system or program before you can access the encrypted data on your drives.

1. Follow the safety guidelines listed in the [Safety instructions](#).
 2. Follow the procedure listed in the [Before working inside your system](#).
 3. Remove the following components:
 - a. [Support bar](#)
 - b. [Air shroud top cover](#)
 - c. [Cooling fan cage assembly](#)
 - d. [Air shroud](#) or [GPU air shroud](#)
NOTE: The GPU air shroud can be removed only after the full length expansion card risers have been removed.
 - e. [BOSS-N1 module](#)
 - f. Disconnect the cables from the PEM.
 - g. [Processor expansion module \(PEM\)](#)
 - h. [Expansion card risers](#) or [full length expansion card riser](#)
 - i. [Riser air shroud](#)
 - j. [Power distribution board \(PDB\)](#)
 - k. [Side wall bracket](#)
 - l. [Memory modules](#)
 - m. [Processor and heat sink module from the system board](#)
 - n. [Internal USB card \(if installed\)](#)
 - o. [OCP card \(if installed\)](#)
 - p. [Power supply units \(PSU\)](#)
 - q. Disconnect all the cables from the system board and make note of all the cable connections.
NOTE: See [cable routing](#) section for more information.
- CAUTION:** Take care not to damage the system identification button while removing the system board from the system.
- CAUTION:** Do not lift the system board by holding a memory module, processor, or other components.

Steps

1. Using the system board holder and plunger, slide the system board towards the front of the system.
2. At a tilted angle, lift the system board out of the chassis.

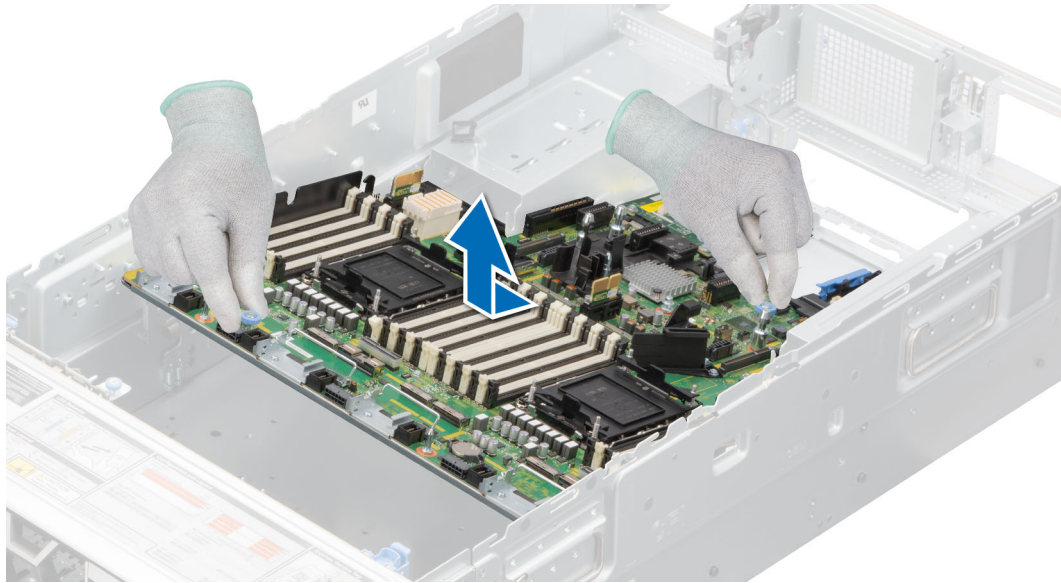

Figure 182. Removing the system board

Next steps

1. [Install the system board.](#)

Installing the system board

Prerequisites

NOTE: Before replacing the system board, replace the old iDRAC MAC address label on the Express Service Tag with the iDRAC MAC address label of the replacement system board.

1. Follow the safety guidelines listed in the [Safety instructions](#).
2. Follow the procedure listed in [Before working inside your system](#).
3. If you are replacing the system board, remove all the components that are listed in the [removing the system board](#) section.

NOTE: Take care not to damage the system board with the chassis pins and clips.

Steps

1. Unpack the new system board assembly.

CAUTION: Do not lift the system board by holding a memory module, processor, or other components.

CAUTION: Take care not to damage the system identification button while placing the system board into the chassis.

2. Holding the system board holder and plunger, lower the system board at a tilted angle into the system.

NOTE: Align the system board with the system board alignment mark on the chassis.

3. Slide the system board towards the rear of the chassis until the connectors are firmly seated in the slots.

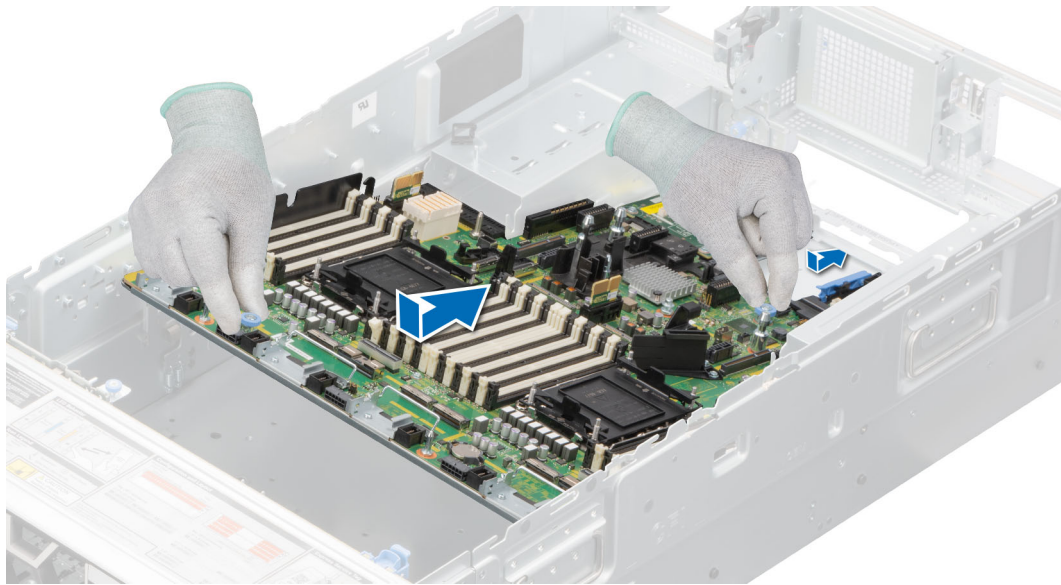

Figure 183. Installing the system board

Next steps

1. Replace the following components:
 - a. [Trusted Platform Module \(TPM\)](#)
 - i** **NOTE:** The TPM Module must be replaced only while installing new system board.
 - b. [OCP card \(if removed\)](#)
 - c. [Internal USB card \(if removed\)](#)
 - d. [Processor and heat sink module to the system board](#) or
 - e. Connect all the removed cables to the system board.
 - f. [Memory modules](#)
 - g. [Power distribution board \(PDB\)](#)
 - h. [Riser air shroud](#)
 - i. [Processor expansion module \(PEM\)](#)
 - j. Connect all the removed cables to the PEM.
 - i** **NOTE:** See [cable routing](#) section for more information.
 - k. [Expansion card risers](#) or [full length expansion card riser](#)
 - i** **NOTE:** Before installing the full length expansion card risers, install the GPU air shroud.
 - l. [Install the air shroud](#) or [install the GPU air shroud](#)
 - m. [BOSS-N1 module](#)
 - n. [Side wall bracket](#)
 - o. [Cooling fan cage assembly](#)
 - p. [Air shroud top cover](#)
 - q. [Support bar](#)
 - r. [Power supply units \(PSU\)](#)
2. Reconnect all cables to the system board.
 - i** **NOTE:** Ensure that the cables inside the system are routed along the chassis wall and secured using the cable securing bracket.
3. Ensure that you perform the following steps:
 - a. Use the Easy Restore feature to restore the Service Tag. See the [Restoring the system by using the Easy Restore feature](#) section.
 - b. If the service tag is not backed up in the backup flash device, enter the system service tag manually. See the [Manually update the Service Tag](#) by using System Setup section.
 - c. Update the BIOS and iDRAC versions.
 - d. Re-enable the Trusted Platform Module (TPM). See the [Upgrading the Trusted Platform Module](#) section.

4. Follow the procedure listed in [After working inside your system](#).

Restoring the system using Easy Restore

The Easy Restore feature enables you to restore your service tag, license, UEFI configuration, and the system configuration data after replacing the system board. All data is backed up in a backup flash device automatically. If BIOS detects a new system board, and the service tag in the backup flash device, BIOS prompts the user to restore the backup information.

About this task

Below is a list of options/steps available:

Steps

1. Restore the service tag, license, and diagnostics information, press **Y**
2. Navigate to the Lifecycle Controller based restore options, press **N**
3. Restore data from a previously created **Hardware Server Profile**, press **F10**

 **NOTE:** When the restore process is complete, BIOS prompts to restore the system configuration data.

4. Restore data from a previously created **Hardware Server Profile**, press **F10**
5. To restore the system configuration data, press **Y**
6. To use the default configuration settings, press **N**

 **NOTE:** After the restore process is complete, system reboots.

Manually update the Service Tag

After replacing a system board, if Easy Restore fails, follow this process to manually enter the Service Tag, using **System Setup**.

About this task

If you know the system service tag, use the **System Setup** menu to enter the service tag.

Steps

1. Power on the system.
2. To enter the **System Setup**, press **F2**.
3. Click **Service Tag Settings**.
4. Enter the service tag.

 **NOTE:** You can enter the service tag only when the **Service Tag** field is empty. Ensure that you enter the correct service tag. Once the service tag is entered, it cannot be updated or changed. Incorrectly entered service tag will lead to system board replacement.

5. Click **OK**.

LOM card, MIC card, and rear I/O board

Removing the LOM card and rear I/O board

Prerequisites

1. Follow the safety guidelines listed in the [Safety instructions](#).
2. Follow the procedure listed in the [Before working inside your system](#).
3. [Remove the system board](#).

Steps

1. Using a Phillips # 2 screwdriver, remove the screws that secure the LAN on Motherboard (LOM) card and rear I/O board to the system board.
2. Holding the edges, pull the LOM card or rear I/O board to disconnect from the connector on the system board.

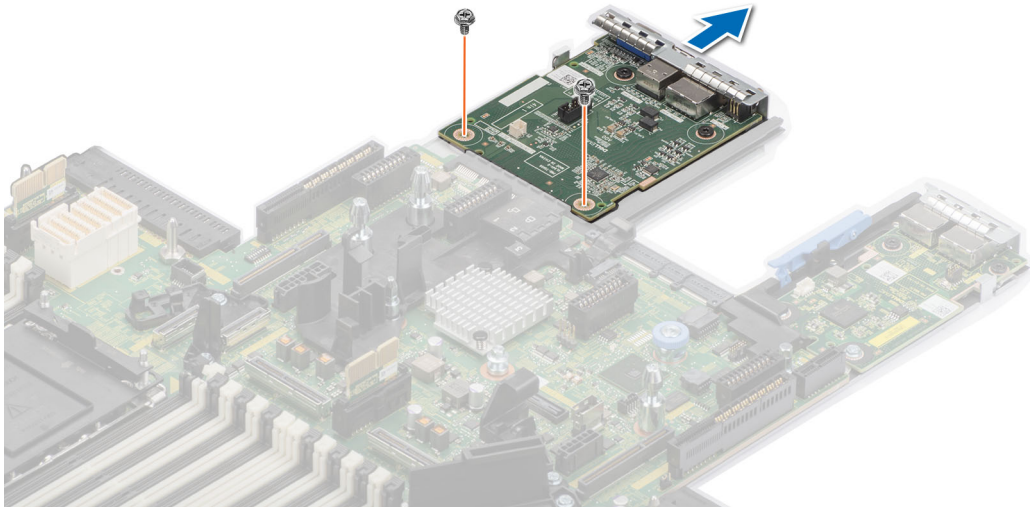

Figure 184. Removing the rear I/O board

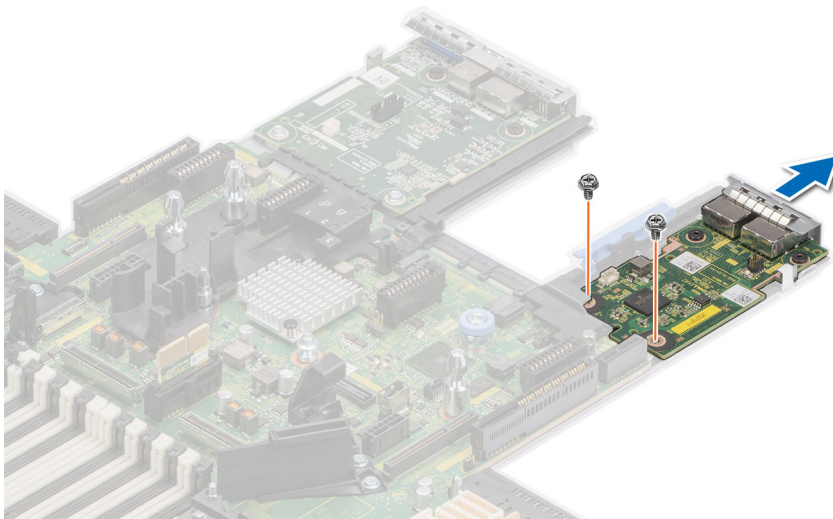

Figure 185. Removing the LOM card

3. If the LOM card is not going to be replaced, install a LOM card blank and tighten the screws.

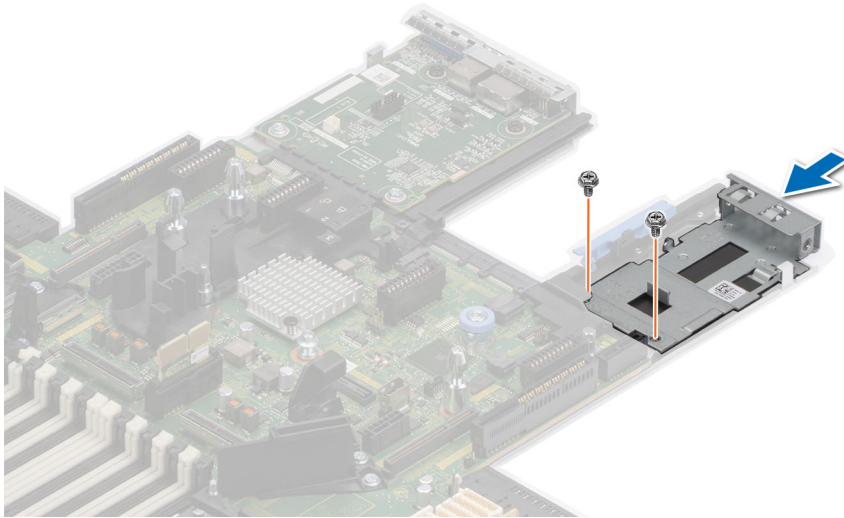

Figure 186. Installing the LOM card blank

Next steps

1. [Replace the LOM card and rear I/O board.](#)

Installing the LOM card and rear I/O board

Prerequisites

1. Follow the safety guidelines listed in the [Safety instructions](#).
2. Follow the procedure listed in the [Before working inside your system](#).
3. [Remove the system board.](#)

Steps

1. If installed, loosen the screws and remove the LOM card blank.

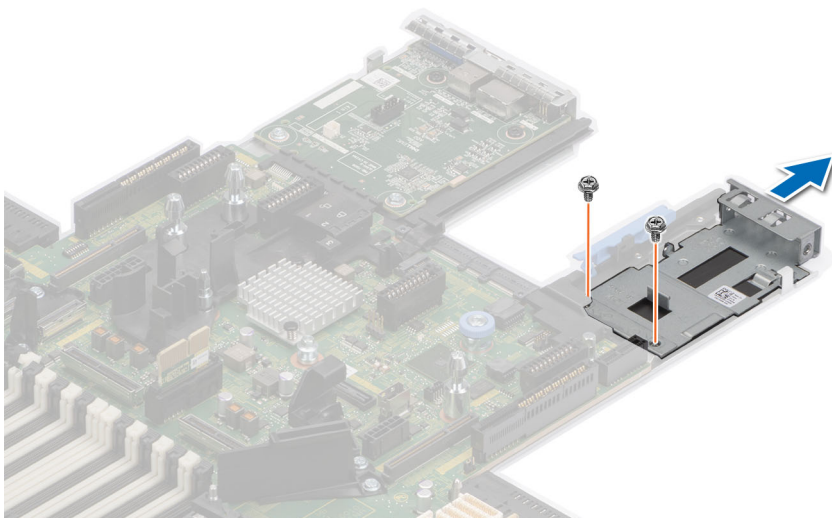

Figure 187. Removing the LOM card blank

2. Align the connectors and slots on the LOM card or rear I/O board with the connector and standoffs on the system board.
3. Press the LOM card or rear I/O board until firmly seated on the system board connector.

- Using a Phillips #2 screwdriver, secure the LOM card or rear I/O board to the system board with screws.

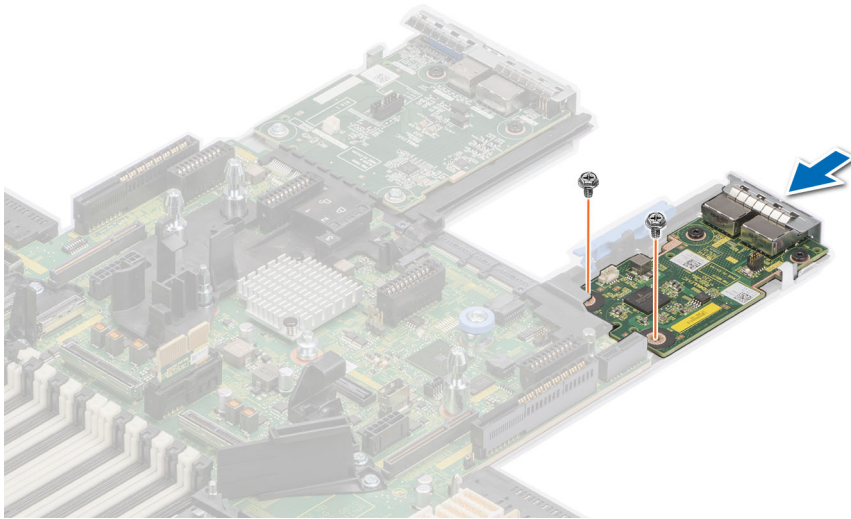

Figure 188. Installing the LOM card

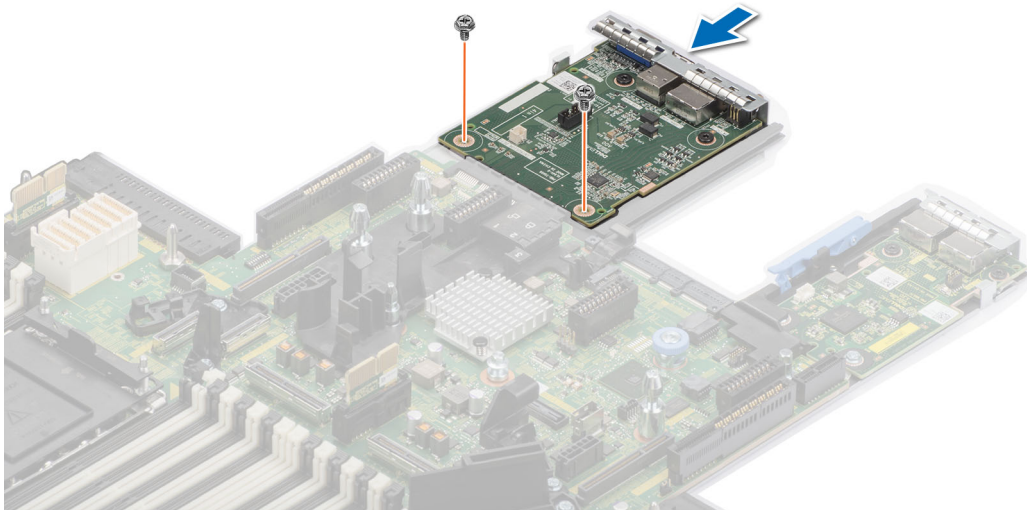

Figure 189. Installing the rear I/O board

Next steps

- [Install the system board.](#)
- Follow the procedure listed in [After working inside your system.](#)

Control panel

This is a service technician replaceable part only.

Removing the right control panel

Prerequisites

- Follow the safety guidelines listed in the [Safety instructions.](#)
- Follow the procedure listed in the [Before working inside your system.](#)

3. Remove the support bar.
4. Remove the air shroud top cover.
5. Remove the cooling fan cage assembly.
6. If installed, [Remove the air shroud](#) or [remove the GPU air shroud](#).
 - i** **NOTE:** The GPU air shroud can be removed only after the full length expansion card risers have been removed.
7. If required, [Remove the expansion card risers](#) or [remove the full length expansion card riser](#).
 - i** **NOTE:** See [cable routing](#) section for more information.
8. Disconnect the UPI and riser cables from the PEM.
9. [Remove the PEM](#).
10. [Remove the side wall bracket](#).

Steps

1. Using the Phillips #1 screwdriver, remove the screws that secure the right control panel and cable cover to the system.
 2. Remove the cable cover away from the system.
 3. Disconnect the right control panel cable and the VGA cable from the connectors on the system board.
 4. Holding the right control panel and VGA cable assembly, slide the right control panel out of the system.
- i** **NOTE:** Observe the routing of the cable assembly as you remove the right control panel from the system.
 - i** **NOTE:** The numbers on the image do not depict the exact steps. The numbers are for representation of sequence.

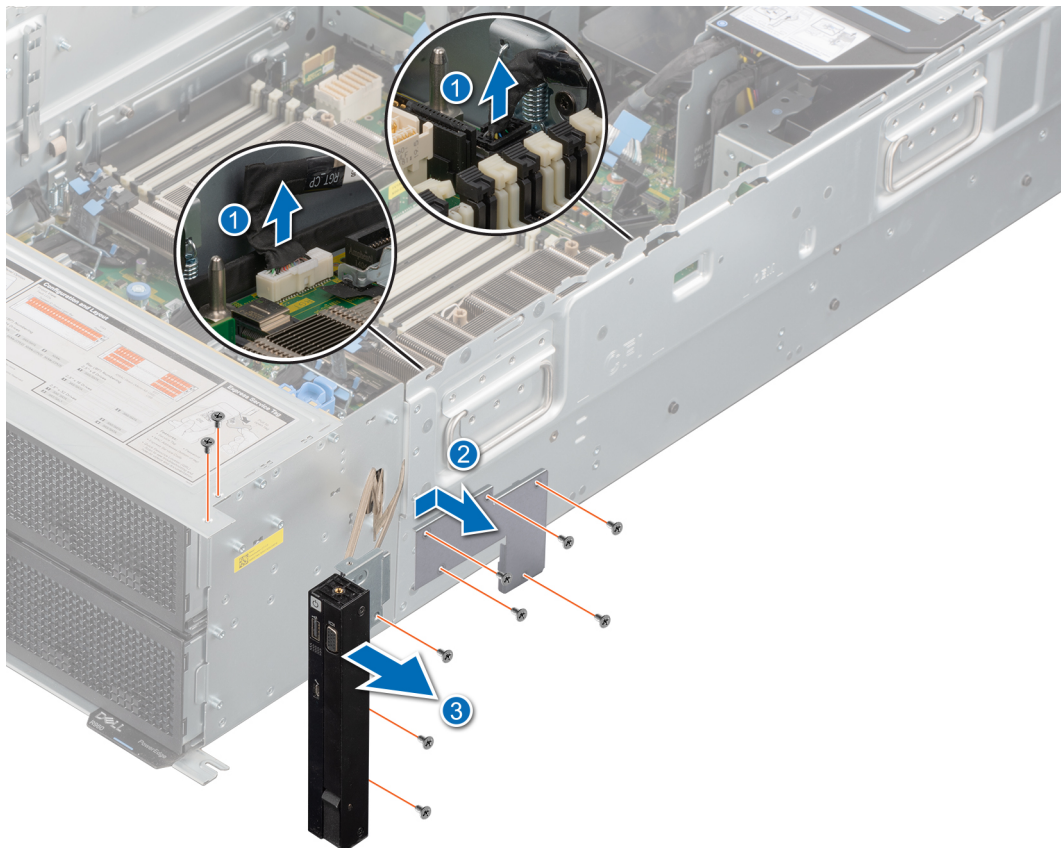

Figure 190. Removing the right control panel

Next steps

1. [Replace the right control panel](#).

Installing the right control panel

Prerequisites

1. Follow the safety guidelines listed in the [Safety instructions](#).
2. Follow the procedure listed in the [Before working inside your system](#).
3. [Remove the support bar](#).
4. [Remove the air shroud top cover](#).
5. [Remove the cooling fan cage assembly](#).
6. If installed, [Remove the air shroud](#) or [remove the GPU air shroud](#).
i **NOTE:** The GPU air shroud can be removed only after the full length expansion card risers have been removed.
7. If required, [Remove the expansion card risers](#) or [remove the full length expansion card riser](#).
i **NOTE:** See [cable routing](#) section for more information.
8. Disconnect the UPI and riser cables from the PEM.
9. [Remove the PEM](#).
10. [Remove the side wall bracket](#).

Steps

1. Align and slide the right control panel into the slot on the system.
2. Route the right control panel cable through the side wall of the system.
3. Align and slide the right control panel cable cover in the slot on the system.
i **NOTE:** Route the cable properly to prevent the cable from being pinched or crimped.
4. Connect the right control panel cable and VGA cable to the connectors on the system board.
5. Using the Phillips #1 screwdriver, tighten the screws that secure the right control panel and the cable cover to the system.
i **NOTE:** The numbers on the image do not depict the exact steps. The numbers are for representation of sequence.

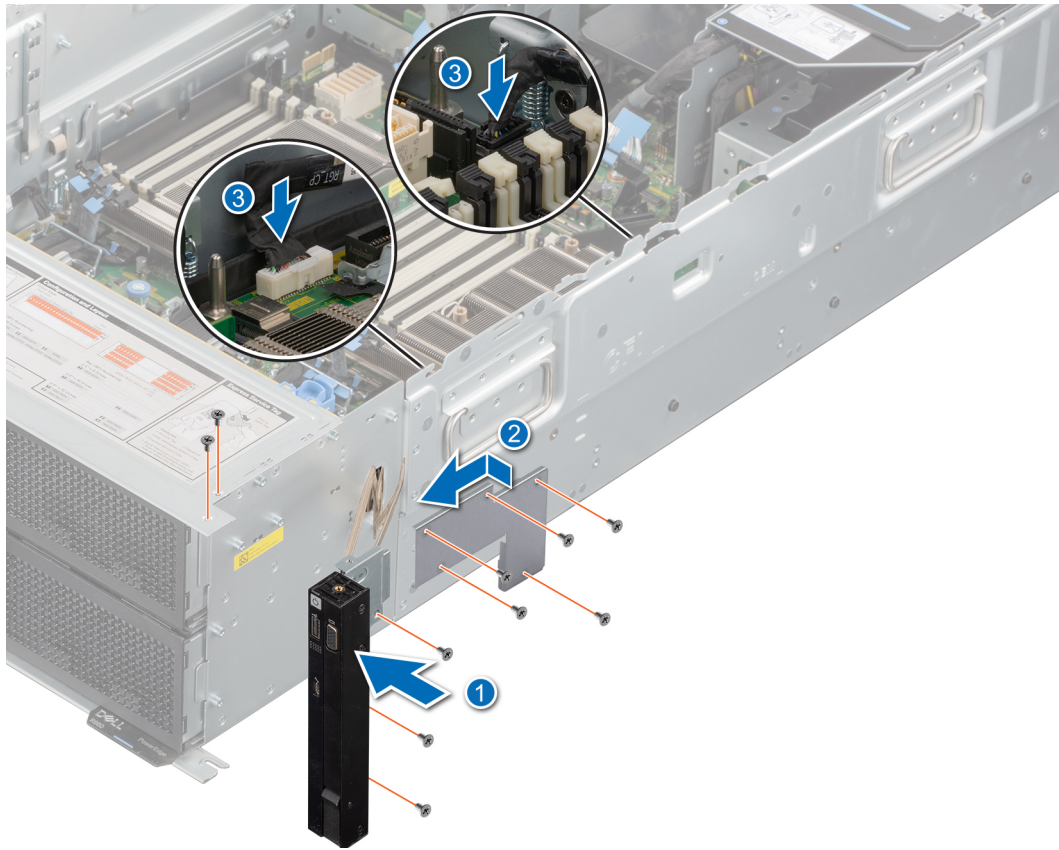

Figure 191. Installing the right control panel

Next steps

1. Install the PEM.
2. If removed, install the expansion card risers or install the full length expansion card riser.
 - i** **NOTE:** Before installing the full length expansion card risers, install the GPU air shroud.
3. Install the side wall bracket.
4. Install the air shroud or install the GPU air shroud.
5. Install the cooling fan cage assembly.
6. Install the air shroud top cover.
7. Install the support bar.
8. Follow the procedure listed in [After working inside your system](#).

Removing the left control panel

Prerequisites

1. Follow the safety guidelines listed in the [Safety instructions](#).
2. Follow the procedure listed in the [Before working inside your system](#).
3. [Remove the support bar](#).
4. [Remove the air shroud top cover](#).
5. [Remove the cooling fan cage assembly](#).
6. If required, [Remove the air shroud](#) or [remove the GPU air shroud](#).
 - i** **NOTE:** The GPU air shroud can be removed only after the full length expansion card risers have been removed.
7. If required, [Remove the expansion card risers](#) or [remove the full length expansion card riser](#).
 - i** **NOTE:** See [cable routing](#) section for more information.
8. Disconnect the UPI and riser cables from the PEM.

9. If required, [remove the PEM](#).
10. [Remove the side wall bracket](#).

Steps

1. Using the Phillips #1 screwdriver, remove the screws that secure the left control panel and the cable cover to the system.
2. Remove the cable cover away from the system.
3. Disconnect the control panel cable from the connector on the system board.
4. Holding the cable, slide the left control panel out of the system.

i **NOTE:** Observe the routing of the cable as you remove the left control panel from the system.

i **NOTE:** The numbers on the image do not depict the exact steps. The numbers are for representation of sequence.

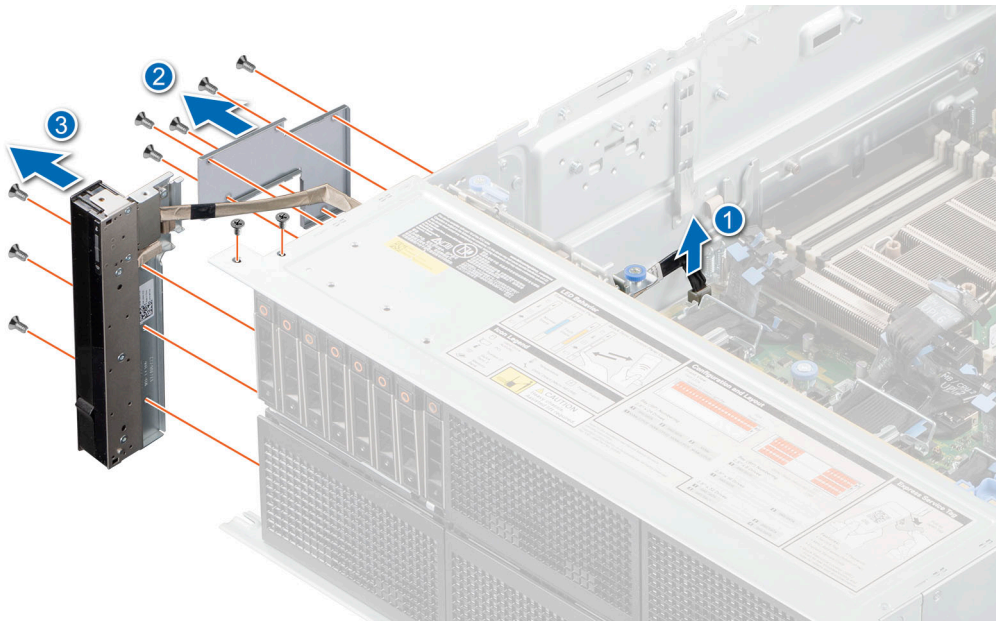

Figure 192. Removing the left control panel

Next steps

1. [Replace the left control panel](#).

Installing the left control panel

Prerequisites

1. Follow the safety guidelines listed in the [Safety instructions](#).
2. Follow the procedure listed in the [Before working inside your system](#).
3. [Remove the support bar](#).
4. [Remove the air shroud top cover](#).
5. [Remove the cooling fan cage assembly](#).
6. If required, [Remove the air shroud](#) or [remove the GPU air shroud](#).
i **NOTE:** The GPU air shroud can be removed only after the full length expansion card risers have been removed.
7. If required, [Remove the expansion card risers](#) or [remove the full length expansion card riser](#).
i **NOTE:** See [cable routing](#) section for more information.
8. Disconnect the UPI and riser cables from the PEM.
9. If required, [remove the PEM](#).
10. [Remove the side wall bracket](#).

Steps

1. Align and slide the left control panel in the slot on the system.
2. Route the left control panel cable through the side wall of the system.
3. Align and slide the left control panel cable cover in the slot on the system.
i **NOTE:** Route the cable properly to prevent the cable from being pinched or crimped.
4. Connect the left control panel cable to the connector on the system board .
5. Using the Phillips #1 screwdriver, tighten the screws to secure the left control panel and the cable cover to the system.
i **NOTE:** The numbers on the image do not depict the exact steps. The numbers are for representation of sequence.

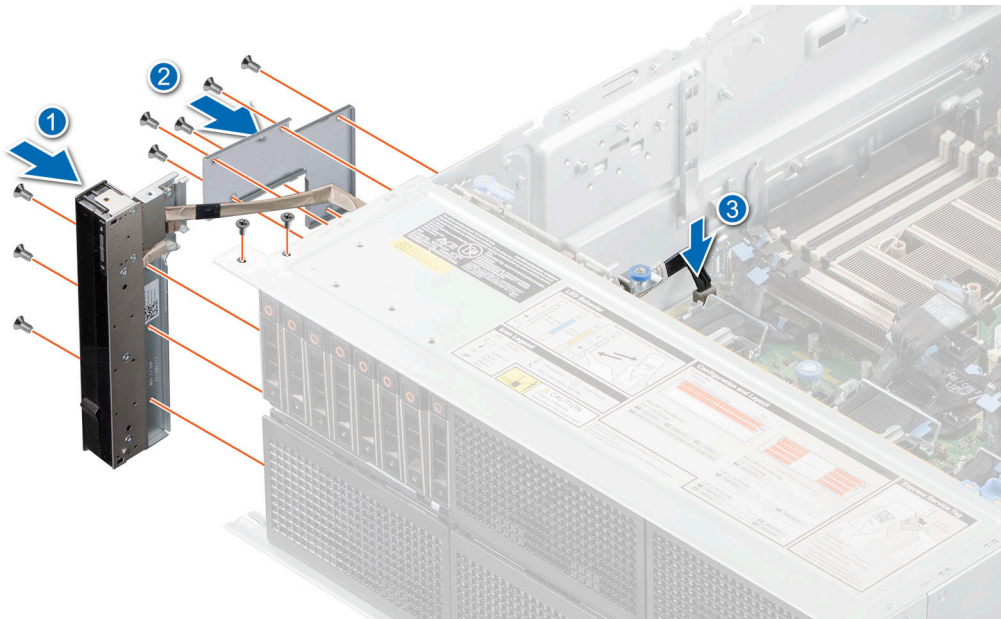

Figure 193. Installing the left control panel

Next steps

1. If removed, [install the PEM](#).
2. If removed, [install the expansion card risers](#) or [install the full length expansion card riser](#).
i **NOTE:** Before installing the full length expansion card risers, install the GPU air shroud.
3. [Install the side wall bracket](#).
4. If removed, [install the air shroud](#) or [install the GPU air shroud](#).
5. [Install the cooling fan cage assembly](#).
6. [Install the air shroud top cover](#).
7. [Install the support bar](#).
8. Follow the procedure listed in [After working inside your system](#).

Upgrade Kits

The table lists the available After Point Of Sale [APOS] kits.

Table 90. Upgrade kits

Kits	Related links to service instructions
Bezel	See Installing the front bezel
M.2 NVMe SSD	See Installing the M.2 NVMe SSD module
BOSS-N1	See Installing the BOSS-N1 controller card module
GPU	See GPU and also see the document included with the GPU cable kit.
Drives	See Installing the drive
Memory	See Installing a memory module
PERC	See Installing the rear mounting front PERC module
Network cards (Standard PCIe adapter LP/FH)	See Installing the LOM card and rear I/O board
Network cards (OCP)	See Installing the OCP card
PCIe SSD card	See Installing the drive
Power cords	Offered, but without special service instructions
Power supplies	See Installing a power supply unit
Quick sync	Offered, but without special service instructions
TPM	See Upgrading the Trusted Platform Module
Processor enablement thermal kits	See Installing the processor
Cables	Offered, but without special service instructions
Heat sink	See Installing a processor heat sink module
Risers	Not available as APOS kits, upgrades offered only with the "Basic Deployment Upgrade of Dell Server" service.
Rail	Offered, but without special service instructions
Cable Management Arm (CMA)	Offered, but without special service instructions

Topics:

- [BOSS-N1 module kit](#)

BOSS-N1 module kit

The BOSS-N1 module supports up to two M.2 NVMe SSDs.

Before you begin the installation or removal process, follow the [safety guidelines](#) and [before working inside the system](#) instructions.

Table 91. BOSS-N1 module kit components

Components in kit	R960 (quantity)
BOSS-N1 controller card module	1
BOSS-N1 card carrier	1 or 2*
M.2 NVMe SSD	1 or 2*
M.2 NVMe SSD capacity label	1 or 2†
BOSS-N1 card carrier blank	1
M3 x 0.5 x 4.5 mm screws	1
BOSS-N1 power cable for Riser 1	1
BOSS-N1 signal cable for Riser 1	1

NOTE: *The quantity depends on the purchase order.

NOTE: †The quantity depends on the BOSS-N1 card carrier.

To remove the BOSS blank :

1. Power off the system and [remove the system cover](#).
2. Use a screwdriver to push out the blank from the BOSS-N1 module bay.

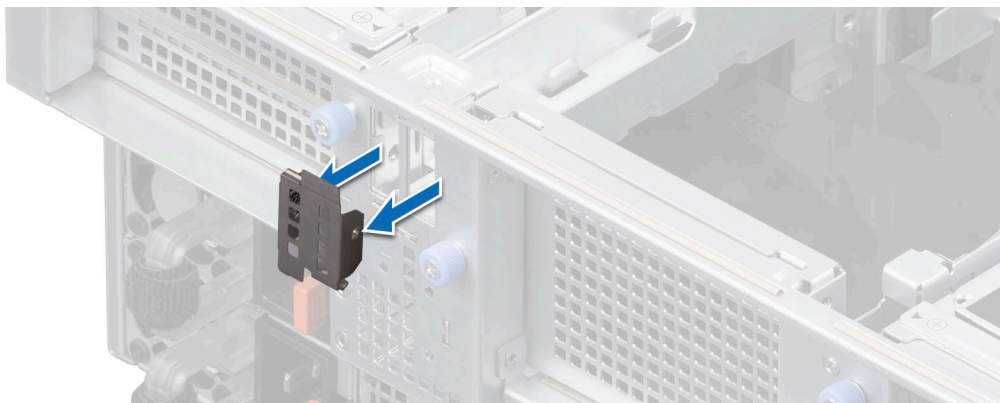

Figure 194. Removing the BOSS-N1 module blank

To install the BOSS-N1 module:

1. To install the BOSS-N1 module , see [installing the BOSS-N1 module](#) steps 1 to 5.
2. To install the M.2 NVMe SSD and BOSS-N1 card carrier, see [installing the BOSS-N1 module](#) steps 6 to 10.

NOTE: Install a BOSS-N1 card carrier blank if you are only using one BOSS-N1 card carrier.

NOTE: See [cable routing](#) section, for more information about connecting the BOSS cables to system board connectors.

NOTE: Installing the BOSS-N1 card carrier does not require the system to be powered off. System shutdown is only required when installing the BOSS-N1 controller card module.

Jumpers and connectors

This topic provides some basic and specific information about jumpers and switches. It also describes the connectors on the various boards in the system. Jumpers on the system board help to disable the system and reset the passwords. To install components and cables correctly, you must know the connectors on the system board.

Topics:

- [System board Connectors](#)
- [System board jumper settings](#)
- [Disabling a forgotten password](#)

System board Connectors

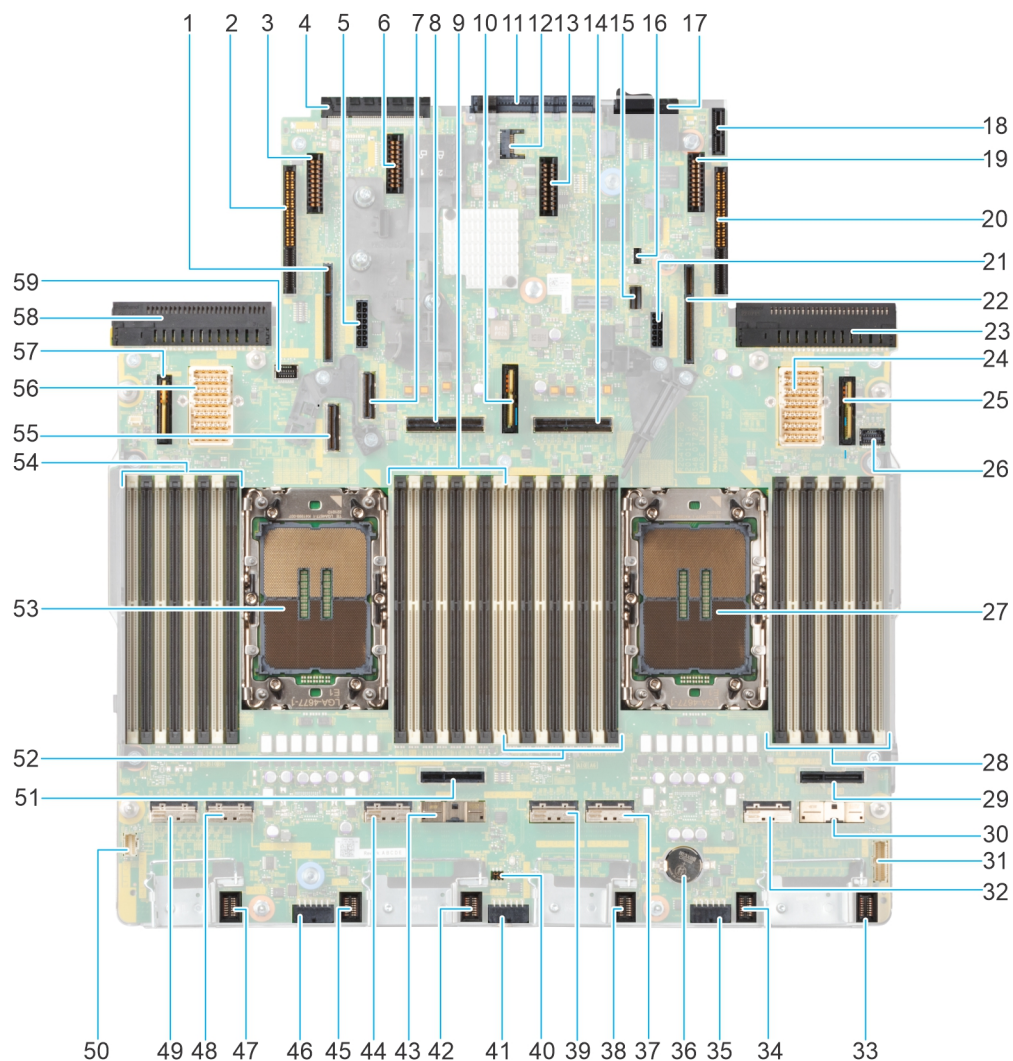

Figure 195. System board jumpers and connectors

Table 92. System board jumpers and connectors

Item	Connector	Description
1.	IO_Riser4 (CPU 2)	Riser 4 slot connector
2.	PPT2	Left PDB Connector
3.	R4_PWR1	Riser 4 Power
4.	RIO	Rear I/O Connector
5.	GPU BATT1	GPU Power 1
6.	R3_PWR1	Riser 3 Power
7.	SL8_CPU2_PB5	PCIe Connector 8
8.	SL9_CPU2_P6	PCIe Connector 9
9.	B9, B1, B15, B7, B11, B3, B13, and B5	DIMMs for CPU 2 for channels A, B, C, and D
10.	PEM PWR 2	PEM Power 2
11.	OCP	OCP NIC 3.0 Connector
12.	TPM	TPM Connector
13.	R2_PWR1	Riser 2 Power
14.	SL10_CPU1_P7	PCIe Connector 10
15.	SL11_PCH_PA8	PCIe Connector 11
16.	BOSS_PWR1	BOSS Card Power
17.	LOM	LOM Connector
18.	Internal USB	Internal USB Connector
19.	R1_ PWR1	Riser 1 Power
20.	PPT1	Right PDB Connector
21.	SIG_PWR0_BATT1	Bay 0 Power
22.	IO_Riser1 (CPU1)	Riser 1 slot connector
23.	PSU1	PSU Connector 1
24.	UPI_PF2	UPI PF 2
25.	PEM_PWR 3	PEM Power 3
26.	VGA	Front VGA Connector
27.	CPU 1	Processor 1
28.	A9, A1, A15, A7, A11, A3, A13, and A5	DIMMs for CPU 1 for channels A, B, C, and D
29.	UPI4	UPI Connector 4
30.	UPI3	UPI Connector 3
31.	CP2	Right Control Panel Connector
32.	SL6_CPU1_PA4	PCIe Connector 6
33.	FAN6	FAN 6
34.	FAN5	FAN 5
35.	PWR3	Bay 3 Power
36.	Battery	Coin cell battery
37.	SL5_CPU1_PB3	PCIe Connector 5

Table 92. System board jumpers and connectors (continued)

Item	Connector	Description
38.	FAN4	FAN 4
39.	SL4_CPU1_PA3	PCIe Connector 4
40.	PWRD_EN and NVRAM_CLR	Jumper
41.	PWR2	Bay 2 Power
42.	FAN3	FAN 3
43.	UPI1	UPI Connector 1
44.	SL3_CPU2_PA2	PCIe Connector 3
45.	FAN2	FAN 2
46.	PWR1	Bay 1 Power
47.	FAN1	FAN 1
48.	SL2_CPU2_PB1	PCIe Connector 2
49.	SL1_CPU2_PA1	PCIe Connector 1
50.	CP1	Left Control Panel Connector
51.	UPI2	UPI Connector 2
52.	A12, A4, A14, A6, A10, A2, A16, and A8	DIMMs for CPU 1 for channels E, F, G, and H
53.	CPU 2	Processor 2
54.	B12, B4, B14, B6, B10, B2, B16, and B8	DIMMs for CPU 2 for channels E, F, G, and H
55.	SL7_CPU2_PA5	PCIe Connector 7
56.	UPI_PF2	UPI PF 2
57.	PEM PWR1	PEM Power 1
58.	PSU2	PSU Connector 2
59.	BBU	Battery Signal Connector

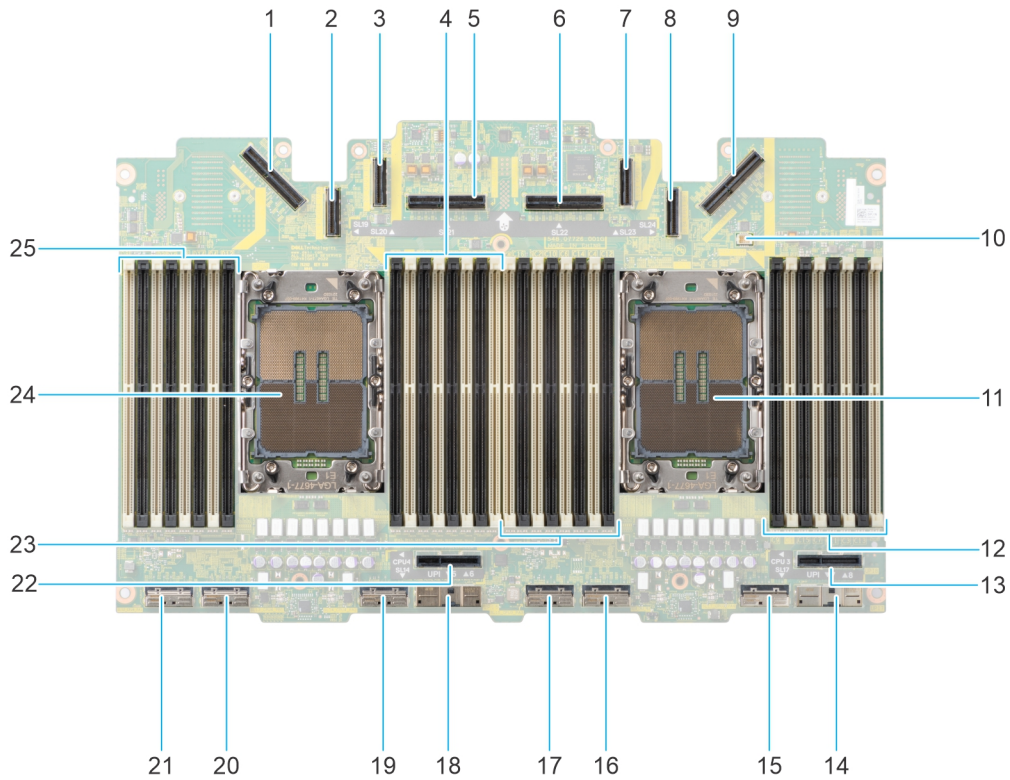

Figure 196. PEM jumpers and connectors

Table 93. PEM board jumpers and connectors

Item	Connector	Description
1.	SL18_CPU4_P5	PCIe Connector 18
2.	SL19_CPU4_PA6	PCIe Connector 19
3.	SL20_CPU4_PB6	PCIe Connector 20
4.	D9, D1, D15, D7, D11, D3, D13, and D5	DIMMs for CPU 4 for channels A, B, C, and D
5.	SL21_CPU4_P7	PCIe Connector 21
6.	SL22_CPU3_P8	PCIe Connector 22
7.	SL23_CPU3_PA9	PCIe Connector 23
8.	SL24_CPU3_PB9	PCIe Connector 24
9.	SL25_CPU3_P10	PCIe Connector 25
10.	PEM_LEAK	PEM Liquid Leak Detect Connector
11.	CPU 3	Processor 3
12.	C9, C1, C15, C7, C11, C3, C13, and C5	DIMMs for CPU 3 for channels A, B, C, and D
13.	UPI8	UPI Connector 8
14.	UPI7	UPI Connector 7
15.	SL17_CPU3_PA4	PCIe Connector 17
16.	SL16_CPU3_PB3	PCIe Connector 16
17.	SL15_CPU3_PA3	PCIe Connector 15
18.	UPI 5	UPI Connector 5
19.	SL14_CPU4_PA2	PCIe Connector 14





Table 93. PEM board jumpers and connectors (continued)

Item	Connector	Description
20.	SL13_CPU4_PB1	PCIe Connector 13
21.	SL12_CPU4_PA1	PCIe Connector 12
22.	UPI6	UPI Connector 6
23.	C12, C4, C14, C6, C10, C2, C16, and C8	DIMMs for CPU 3 for channels E, F, G, and H
24.	CPU4	Processor 4
25.	D12, D4, D14, D6, D10, D2, D16, and D8	DIMMs for CPU 4 for channels E, F, G, and H

System board jumper settings

For information about resetting the password jumper to disable a password, see the [Disabling a forgotten password](#) section.

Table 94. System board jumper settings

Jumper	Setting	Description
PWRD_EN	 2 4 6 (default)	The BIOS password feature is enabled.
	 2 4 6	The BIOS password feature is disabled. The BIOS password is now disabled and you are not allowed to set a new password.
NVRAM_CLR	 1 3 5 (default)	The BIOS configuration settings are retained at system boot.
	 1 3 5	The BIOS configuration settings are cleared at system boot.

CAUTION: You should be cautious when changing the BIOS settings. The BIOS interface is designed for advanced users. Any changes in the setting might prevent your system from starting correctly and may even result in data loss.

Disabling a forgotten password

The software security features of the system include a system password and a setup password. The password jumper enables or disables password features and clears any password(s) currently in use.

Prerequisites

CAUTION: Many repairs may only be done by a certified service technician. You should only perform troubleshooting and simple repairs as authorized in your product documentation, or as directed by the online or telephone service and support team. Damage due to servicing that is not authorized by Dell is not covered by your warranty. Read and follow the safety instructions that are shipped with your product.

Steps

1. Power off the system and all attached peripherals. Disconnect the system from the electrical outlet, and disconnect the peripherals.
2. [Remove the system cover.](#)
3. Move the jumper on the system board from pins 2 and 4 to pins 4 and 6.
4. [Replace the system cover.](#)

NOTE: The existing passwords are not disabled (erased) until the system boots with the jumper on pins 4 and 6. However, before you assign a new system and/or setup password, you must move the jumper back to pins 2 and 4.

 **NOTE:** If you assign a new system and/or setup password with the jumper on pins 4 and 6, the system disables the new password(s) the next time it boots.

5. Reconnect the peripherals and connect the system to the electrical outlet, and then power on the system.
6. Power off the system.
7. [Remove the system cover.](#)
8. Move the jumper on the system board from pins 4 and 6 to pins 2 and 4.
9. [Replace the system cover.](#)
10. Reconnect the peripherals and connect the system to the electrical outlet, and then power on the system.
11. Assign a new system and/or setup password.

System diagnostics and indicator codes

The diagnostic indicators on the system front panel display system status during system startup.

Topics:

- Power button LED
- Status LED indicators
- System health and system ID indicator codes
- iDRAC Quick Sync 2 indicator codes
- iDRAC Direct LED indicator codes
- LCD panel
- NIC indicator codes
- Power supply unit indicator codes
- Drive indicator codes
- EDSFF E3.S drive led codes
- Using system diagnostics

Power button LED

The power button LED is on the front panel of your system.



Figure 197. Power button LED

Table 95. Power button LED

Power button LED indicator code	Condition
Off	System is not operating, regardless of power supply available.
On	System is operating, one or more of the non-standby power supply units are active.
Slowly blinking	System is performing powering on sequence, and iDRAC is still booting.

Status LED indicators

NOTE: The indicators display solid amber if any error occurs.

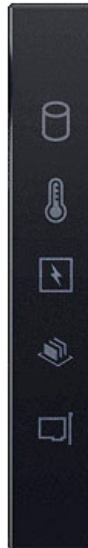







Figure 198. Status LED indicators

Table 96. Status LED indicators and descriptions

Icon	Description	Condition	Corrective action
	Drive indicator	The indicator turns solid amber if there is a drive error.	<ul style="list-style-type: none"> • Check the System Event Log to determine if the drive has an error. • Run the appropriate Online Diagnostics test. Restart the system and run embedded diagnostics (ePSA). • If the drives are configured in a RAID array, restart the system, and enter the host adapter configuration utility program.
	Temperature indicator	The indicator turns solid amber if the system experiences a thermal error (for example, the ambient temperature is out of range or there is a fan failure).	<p>Ensure that none of the following conditions exist:</p> <ul style="list-style-type: none"> • A cooling fan has been removed or has failed. • System cover, air shrouds, or back filler bracket has been removed. • Ambient temperature is too high. • External airflow is obstructed. <p>If the problem persists, see the Getting help section.</p>
	Electrical indicator	The indicator turns solid amber if the system experiences an electrical error (for example, voltage out of range, or a failed power supply unit (PSU) or voltage regulator).	<p>Check the System Event Log or system messages for the specific issue. If it is due to a problem with the PSU, check the LED on the PSU. Reseat the PSU.</p> <p>If the problem persists, see the Getting help section.</p>
	Memory indicator	The indicator turns solid amber if a memory error occurs.	<p>Check the System Event Log or system messages for the location of the failed memory. Reseat the memory module.</p> <p>If the problem persists, see the Getting help section.</p>
	PCIe indicator	The indicator turns solid amber if a PCIe card experiences an error.	<p>Restart the system. Update any required drivers for the PCIe card. Reinstall the card.</p> <p>If the problem persists, see the Getting help section.</p>

System health and system ID indicator codes

The system health and system ID indicator is located on the left control panel of the system.



Figure 199. System health and system ID indicator

Table 97. System health and system ID indicator codes

System health and system ID indicator code	Condition
Solid blue	Indicates that the system is powered on, is healthy, and system ID mode is not active. Press the system health and system ID button to switch to system ID mode.
Blinking blue	Indicates that the system ID mode is active. Press the system health and system ID button to switch to system health mode.
Solid amber	Indicates that the system is in fail-safe mode. If the problem persists, see the Getting help section.
Blinking amber	Indicates that the system is experiencing a fault. Check the System Event Log for specific error messages. For information about the event and error messages generated by the system firmware and agents that monitor system components, go to qrl.dell.com > Look Up > Error Code , type the error code, and then click Look it up .

iDRAC Quick Sync 2 indicator codes

iDRAC Quick Sync 2 module (optional) is located on the left control panel front IO panel of the system.



Table 98. iDRAC Quick Sync 2 indicators and descriptions

iDRAC Quick Sync 2 indicator code	Condition	Corrective action
Off (default state)	Indicates that the iDRAC Quick Sync 2 feature is powered off. Press the iDRAC Quick Sync 2 button to power on the iDRAC Quick Sync 2 feature.	If the LED fails to power on, reseal the left control panel flex cable and check. If the problem persists, see the Getting help section.
Solid white	Indicates that iDRAC Quick Sync 2 is ready to communicate. Press the iDRAC Quick Sync 2 button to power off.	If the LED fails to power off, restart the system. If the problem persists, see the Getting help section.
Blinks white rapidly	Indicates data transfer activity.	If the indicator continues to blink indefinitely, see the Getting help section.
Blinks white slowly	Indicates that firmware update is in progress.	If the indicator continues to blink indefinitely, see the Getting help section.
Blinks white five times rapidly and then powers off	Indicates that the iDRAC Quick Sync 2 feature is disabled.	Check if iDRAC Quick Sync 2 feature is configured to be disabled by iDRAC. If the problem persists, see the Getting help section. www.dell.com/poweredgemanuals or <i>Dell OpenManage Server Administrator User's Guide</i> at https://www.dell.com/openmanagemanuals .
Solid amber	Indicates that the system is in fail-safe mode.	Restart the system. If the problem persists, see the Getting help section.
Blinking amber	Indicates that the iDRAC Quick Sync 2 hardware is not responding properly.	Restart the system. If the problem persists, see the Getting help section.

iDRAC Direct LED indicator codes

The iDRAC Direct LED indicator lights up to indicate that the port is connected and is being used as a part of the iDRAC subsystem.

You can configure iDRAC Direct by using a USB to micro USB (type AB) cable, which you can connect to your laptop or tablet. Cable length should not exceed 3 feet (0.91 meters). Performance could be affected by cable quality. The following table describes iDRAC Direct activity when the iDRAC Direct port is active:

Table 99. iDRAC Direct LED indicator codes

iDRAC Direct LED indicator code	Condition
Solid green for two seconds	Indicates that the laptop or tablet is connected.
Blinking green (on for two seconds and off for two seconds)	Indicates that the laptop or tablet connected is recognized.

Table 99. iDRAC Direct LED indicator codes (continued)

iDRAC Direct LED indicator code	Condition
LED Indicator off	Indicates that the laptop or tablet is unplugged.

LCD panel

The LCD panel provides system information, status, and error messages to indicate if the system is functioning correctly or requires attention. The LCD panel is used to configure or view the iDRAC IP address of the system. For information about the event and error messages generated by the system firmware and agents that monitor system components, go to qrl.dell.com > **Look Up** > **Error Code**, type the error code, and then click **Look it up**.

The LCD panel is available only on the optional front bezel. The optional front bezel is hot pluggable.

The status and conditions of the LCD panel are outlined here:

- The LCD backlight is white during normal operating conditions.
- If there is an issue, the LCD backlight turns amber and displays an error code followed by descriptive text.
 - ⓘ **NOTE:** If the system is connected to a power source and an error is detected, the LCD turns amber regardless of whether the system is powered on or off.
- When the system powers off and there are no errors, the LCD enters the standby mode after five minutes of inactivity. Press any button on the LCD to power it on.
- If the LCD panel stops responding, remove the bezel and reinstall it.
 - If the problem persists, see [Getting help](#).
- The LCD backlight remains off if LCD messaging is powered off using the iDRAC utility, the LCD panel, or other tools.

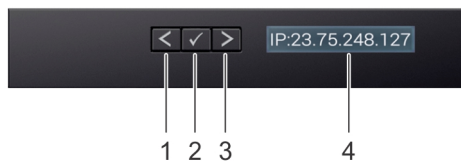

Figure 200. LCD panel features



Table 100. LCD panel features

Item	Button or display	Description
1	Left	Moves the cursor back in one-step increments.
2	Select	Selects the menu item highlighted by the cursor.
3	Right	Moves the cursor forward in one-step increments. During message scrolling: <ul style="list-style-type: none"> • Press and hold the right button to increase scrolling speed. • Release the button to stop. ⓘ NOTE: The display stops scrolling when the button is released. After 45 seconds of inactivity, the display starts scrolling.
4	LCD display	Displays the system information, status, and error messages or iDRAC IP address.

Viewing Home screen

The **Home** screen displays user-configurable information about the system. This screen is displayed during normal system operation when there are no status messages or errors. When the system turns off and there are no errors, LCD enters the standby mode after five minutes of inactivity. Press any button on the LCD to turn it on.

Steps

1. To view the **Home** screen, press one of the three navigation buttons (Select, Left, or Right).
2. To navigate to the **Home** screen from another menu, complete the following steps:
 - a. Press and hold the navigation button till the up arrow  is displayed.
 - b. Navigate to the **Home** icon  using the up arrow .
 - c. Select the **Home** icon.
 - d. On the **Home** screen, press the **Select** button to enter the main menu.

Setup menu

 **NOTE:** When you select an option in the Setup menu, you must confirm the option before proceeding to the next action.

Table 101. Setup menu

Option	Description
iDRAC	Select DHCP or Static IP to configure the network mode. If Static IP is selected, the available fields are IP , Subnet (Sub) , and Gateway (Gtw) . Select Setup DNS to enable DNS and to view domain addresses. Two separate DNS entries are available.
Set error	Select SEL to view LCD error messages in a format that matches the IPMI description in the SEL. This enables you to match an LCD message with an SEL entry. Select Simple to view LCD error messages in a simplified user-friendly description. For information about the event and error messages generated by the system firmware and agents that monitor system components, go to qrl.dell.com > Look Up > Error Code , type the error code, and then click Look it up ..
Set home	Select the default information to be displayed on the Home screen. See View Home menu section for the options and option items that can be set as the default on the Home screen.

View menu

 **NOTE:** When you select an option in the View menu, you must confirm the option before proceeding to the next action.

Table 102. View menu

Option	Description
iDRAC IP	Displays the IPv4 or IPv6 addresses for iDRAC9. Addresses include DNS (Primary and Secondary) , Gateway, IP , and Subnet (IPv6 does not have Subnet).
MAC	Displays the MAC addresses for iDRAC , iSCSI , or Network devices.
Name	Displays the name of the Host , Model , or User String for the system.
Number	Displays the Asset tag or the Service tag for the system.
Power	Displays the power output of the system in BTU/hr or Watts. The display format can be configured in the Set home submenu of the Setup menu.
Temperature	Displays the temperature of the system in Celsius or Fahrenheit. The display format can be configured in the Set home submenu of the Setup menu.

NIC indicator codes

Each NIC on the back of the system has indicators that provide information about the activity and link status. The activity LED indicator indicates if data is flowing through the NIC, and the link LED indicator indicates the speed of the connected network.

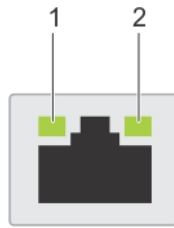

Figure 201. NIC indicator codes

1. Link LED indicator
2. Activity LED indicator

Table 103. NIC indicator codes

NIC indicator codes	Condition
Link and activity indicators are off.	Indicates that the NIC is not connected to the network.
Link indicator is green, and activity indicator is blinking green.	Indicates that the NIC is connected to a valid network at its maximum port speed, and data is being sent or received.
Link indicator is amber, and activity indicator is blinking green.	Indicates that the NIC is connected to a valid network at less than its maximum port speed, and data is being sent or received.
Link indicator is green, and activity indicator is off.	Indicates that the NIC is connected to a valid network at its maximum port speed, and data is not being sent or received.
Link indicator is amber, and activity indicator is off.	Indicates that the NIC is connected to a valid network at less than its maximum port speed, and data is not being sent or received.
Link indicator is blinking green, and activity is off.	Indicates that the NIC identity is enabled through the NIC configuration utility.

Power supply unit indicator codes

AC and DC power supply units (PSUs) have an illuminated translucent handle that serves as an indicator. The indicator shows if power is present or if a power fault has occurred.

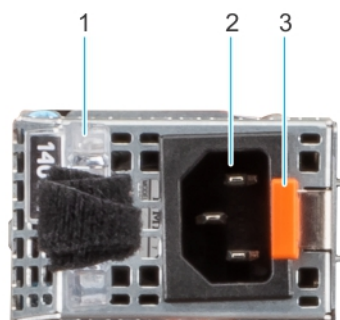

Figure 202. AC PSU status indicator

1. AC PSU handle
2. Socket
3. Release latch

Table 104. AC and DC PSU status indicator codes

Power indicator codes	Condition
Green	Indicates that a valid power source is connected to the PSU and the PSU is operational.
Blinking amber	Indicates an issue with the PSU.
Not powered on	Indicates that the power is not connected to the PSU.
Blinking green	<p>Indicates that the firmware of the PSU is being updated.</p> <p>⚠ CAUTION: Do not disconnect the power cord or unplug the PSU when updating firmware. If firmware update is interrupted, the PSUs will not function.</p>
Blinking greens and powers off	<p>When hot-plugging a PSU, it blinks green five times at a rate of 4 Hz and powers off. This indicates a PSU mismatch due to efficiency, feature set, health status, or supported voltage.</p> <p>⚠ CAUTION: If two PSUs are installed, both the PSUs must have the same type of label; for example, Extended Power Performance (EPP) label. Mixing PSUs from previous generations of PowerEdge servers is not supported, even if the PSUs have the same power rating. This results in a PSU mismatch condition or failure to power on the system.</p> <p>⚠ CAUTION: If two PSUs are used, they must be of the same type and have the same maximum output power.</p> <p>⚠ CAUTION: When correcting a PSU mismatch, replace the PSU with the blinking indicator. Swapping the PSU to make a matched pair can result in an error condition and an unexpected system shutdown. To change from a high output configuration to a low output configuration or vice versa, you must power off the system.</p> <p>⚠ CAUTION: AC PSUs support both 240 V and 120 V input voltages with the exception of Titanium PSUs, which support only 240 V. When two identical PSUs receive different input voltages, they can output different wattages, and trigger a mismatch.</p>

Drive indicator codes

The LEDs on the drive carrier indicate the state of each drive. Each drive carrier has two LEDs: an activity LED (green) and a status LED (bicolor, green/amber). The activity LED blinks whenever the drive is accessed.

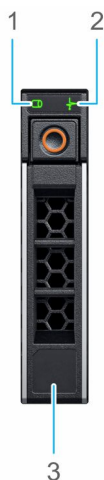

Figure 203. Drive indicators

- 1. Drive activity LED indicator
- 2. Drive status LED indicator
- 3. Drive capacity label

NOTE: If the drive is in the Advanced Host Controller Interface (AHCI) mode, the status LED indicator does not power on.

NOTE: Drive status indicator behavior is managed by Storage Spaces Direct. Not all drive status indicators may be used.

Table 105. Drive indicator codes

Drive status indicator code	Condition
Blinks green twice per second	Indicates that the drive is being identified or preparing for removal.
Not powered on	Indicates that the drive is ready for removal. NOTE: The drive status indicator remains off until all drives are initialized after the system is powered on. Drives are not ready for removal during this time.
Blinks green, amber, and then powers off	Indicates that there is an unexpected drive failure.
Blinks amber four times per second	Indicates that the drive has failed.
Blinks green slowly	Indicates that the drive is rebuilding.
Solid green	Indicates that the drive is online.
Blinks green for three seconds, amber for three seconds, and then powers off after six seconds	Indicates that the rebuild has stopped.

EDSFF E3.S drive led codes

The LEDs on the drive carrier indicate the state of each drive. The LEDs on the EDSFF E3.S drive have two LEDs: an activity LED (green) and a locate/fault LED (blue/amber). The activity LED blinks whenever the drive is accessed.



Figure 204. EDSFF E3.S drive indicators

1. Drive activity LED indicator
2. Drive status LED indicator
3. Drive capacity label

EDSFF E3.S drive led codes

E3.S hard drives have Green LED and Blue/Amber LED.

- Green LED shows : Drive power status , Activity
- Blue/Amber LED shows: Drive Fault, Locate

EDSFF indicator behavior

Table 106. EDSFF indicator behavior

Pattern Name	Description	Blue Element	Amber Element
Locate	This device is being identified.	ON (1 sec ON 1 sec OFF)	OFF
Fault	The device is in a fault condition.	OFF	ON (2 sec ON 1 sec OFF)
N/A	This device does not have fault or locate device.	OFF	OFF

NOTE: Locate behavior overrides Fault state.

Green LED

The green LED is driven and controlled by the device. The two functions for this LED are defined as follows:

- Power: This function indicates that the device has power and has no issues with its power regulation. Once the green LED is ON, it shall either remain ON or blink at the activity frequency unless the device determines power is no longer within its operating range.
- Activity: This function indicates if the device is being used.

Table 107. LED and device state per function for Green LED

Function/Device state	LED state
Power ON/Device is powered, no activity occurring.	ON
Activity/Device is powered, host initiated I/O activity occurring.	4 Hz nominal blink rate
Power OFF/Device is not powered.	OFF

Using system diagnostics

If you experience an issue with the system, run the system diagnostics before contacting Dell for technical assistance. The purpose of running system diagnostics is to test the system hardware without using additional equipment or risking data loss. If you are unable to fix the issue yourself, service and support personnel can use the diagnostics results to help you solve the issue.

Dell Embedded System Diagnostics

NOTE: The Dell Embedded System Diagnostics is also known as Enhanced Pre-boot System Assessment (ePSA) diagnostics.

The Embedded System Diagnostics provide a set of options for particular device groups or devices allowing you to:

- Run tests automatically or in an interactive mode
- Repeat tests
- Display or save test results
- Run thorough tests to introduce additional test options to provide extra information about the failed device(s)
- View status messages that inform you if tests are completed successfully
- View error messages that inform you of issues encountered during testing

Running the Embedded System Diagnostics from Boot Manager

Run the Embedded System Diagnostics (ePSA) if your system does not boot.

Steps

1. When the system is booting, press F11.
2. Use the up arrow and down arrow keys to select **System Utilities > Launch Diagnostics**.
3. Alternatively, when the system is booting, press F10, select **Hardware Diagnostics > Run Hardware Diagnostics**.
The **ePSA Pre-boot System Assessment** window is displayed, listing all devices detected in the system. The diagnostics starts executing the tests on all the detected devices.

Running the Embedded System Diagnostics from the Dell Lifecycle Controller

Steps

1. When the system is booting, press F10.
2. Select **Hardware Diagnostics → Run Hardware Diagnostics**.
The **ePSA Pre-boot System Assessment** window is displayed, listing all devices detected in the system. The diagnostics start executing the tests on all the detected devices.

System diagnostic controls

Table 108. System diagnostic controls

Menu	Description
Configuration	Displays the configuration and status information of all detected devices.
Results	Displays the results of all tests that are run.
System health	Provides the current overview of the system performance.
Event log	Displays a time-stamped log of the results of all tests run on the system. This is displayed if at least one event description is recorded.

Getting help

Topics:

- [Recycling or End-of-Life service information](#)
- [Contacting Dell Technologies](#)
- [Accessing system information by using QRL](#)
- [Receiving automated support with Secure Connect Gateway \(SCG\)](#)

Recycling or End-of-Life service information

Take back and recycling services are offered for this product in certain countries. If you want to dispose of system components, visit www.dell.com/recyclingworldwide and select the relevant country.

Contacting Dell Technologies

Dell provides online and telephone based support and service options. If you do not have an active internet connection, you can find Dell contact information on your purchase invoice, packing slip, bill or Dell product catalog. The availability of services varies depending on the country and product, and some services may not be available in your area. To contact Dell for sales, technical assistance, or customer service issues follow these steps:

Steps

1. Go to www.dell.com/support/home.
2. Select your country from the drop-down menu on the lower right corner of the page.
3. For customized support:
 - a. Enter the system Service Tag in the **Enter a Service Tag, Serial Number, Service Request, Model, or Keyword** field.
 - b. Click **Search**.
The support page that lists the various support categories is displayed.
4. For general support:
 - a. Select your product category.
 - b. Select your product segment.
 - c. Select your product.
The support page that lists the various support categories is displayed.
5. For contact details of Dell Global Technical Support:
 - a. Click [Contact Technical Support](#).
 - b. The **Contact Technical Support** page is displayed with details to call, chat, or e-mail the Dell Global Technical Support team.

Accessing system information by using QRL

You can use the Quick Resource Locator (QRL) located on the Express service tag in the front of the R960 system, to access information about PowerEdge R960. There is also another QRL for accessing product information located on the back of the system cover.

Prerequisites

Ensure that your smartphone or tablet has a QR code scanner installed.

The QRL includes the following information about your system:

- How-to videos
- Reference materials, including the Installation and Service Manual, and mechanical overview
- The system service tag to quickly access the specific hardware configuration and warranty information
- A direct link to Dell to contact technical assistance and sales teams

Steps

1. Go to www.dell.com/qrl, and navigate to your specific product or
2. Use your smart phone or tablet to scan the model-specific Quick Resource (QR) code on your system or in the Quick Resource Locator section.

Quick Resource Locator for PowerEdge R960 system



Quick Resource Locator

Dell.com/QRL/Server/PER960

Figure 205. Quick Resource Locator for PowerEdge R960 system

Receiving automated support with Secure Connect Gateway (SCG)

Dell Secure Connect Gateway (SCG) is an optional Dell Services offering that automates technical support for your Dell server, storage, and networking devices. By installing and setting up a Secure Connect Gateway (SCG) application in your IT environment, you can receive the following benefits:

- Automated issue detection — Secure Connect Gateway (SCG) monitors your Dell devices and automatically detects hardware issues, both proactively and predictively.
- Automated case creation — When an issue is detected, Secure Connect Gateway (SCG) automatically opens a support case with Dell Technical Support.
- Automated diagnostic collection — Secure Connect Gateway (SCG) automatically collects system state information from your devices and uploads it securely to Dell. This information is used by Dell Technical Support to troubleshoot the issue.
- Proactive contact — A Dell Technical Support agent contacts you about the support case and helps you resolve the issue.

The available benefits vary depending on the Dell Service entitlement purchased for your device. For more information about Secure Connect Gateway (SCG), go to www.dell.com/secureconnectgateway.

Documentation resources

This section provides information about the documentation resources for your system.

To view the document that is listed in the documentation resources table:

- From the Dell support site:
 1. Click the documentation link that is provided in the Location column in the table.
 2. Click the required product or product version.
-  **NOTE:** To locate the model number, see the front of your system.
- 3. On the Product Support page, click **Documentation**.
- Using search engines:
 - Type the name and version of the document in the search box.

Table 109. Additional documentation resources for your system

Task	Document	Location
Setting up your system	<p>For more information about installing and securing the system into a rack, see the Rail Installation Guide included with your rail solution.</p> <p>For information about setting up your system, see the <i>Getting Started Guide</i> document that is shipped with your system.</p>	www.dell.com/poweredgemanuals
Configuring your system	<p>For information about the iDRAC features, configuring and logging in to iDRAC, and managing your system remotely, see the Integrated Dell Remote Access Controller User's Guide.</p> <p>For information about understanding Remote Access Controller Admin (RACADM) subcommands and supported RACADM interfaces, see the RACADM CLI Guide for iDRAC.</p> <p>For information about Redfish and its protocol, supported schema, and Redfish Eventing implemented in iDRAC, see the Redfish API Guide.</p> <p>For information about iDRAC property database group and object descriptions, see the Attribute Registry Guide.</p> <p>For information about Intel QuickAssist Technology, see the Integrated Dell Remote Access Controller User's Guide.</p>	www.dell.com/poweredgemanuals
	<p>For information about earlier versions of the iDRAC documents.</p> <p>To identify the version of iDRAC available on your system, on the iDRAC web interface, click ? > About.</p>	www.dell.com/idracmanuals

Table 109. Additional documentation resources for your system (continued)

Task	Document	Location
	For information about installing the operating system, see the operating system documentation.	www.dell.com/operatingsystemmanuals
	For information about updating drivers and firmware, see the Methods to download firmware and drivers section in this document.	www.dell.com/support/drivers
Managing your system	For information about systems management software offered by Dell, see the Dell OpenManage Systems Management Overview Guide.	www.dell.com/poweredgemanuals
	For information about setting up, using, and troubleshooting OpenManage, see the Dell OpenManage Server Administrator User's Guide.	www.dell.com/openmanagemanuals > OpenManage Server Administrator
	For information about installing and using Dell Secure Connect Gateway, see the Dell Secure Connect Gateway Enterprise User's Guide.	https://www.dell.com/serviceabilitytools
	For information about partner programs enterprise systems management, see the OpenManage Connections Enterprise Systems Management documents.	www.dell.com/openmanagemanuals
Working with the Dell PowerEdge RAID controllers (if applicable)	For information about understanding the features of the Dell PowerEdge RAID controllers (PERC), Software RAID controllers, or BOSS card and deploying the cards, see the Storage controller documentation.	www.dell.com/storagecontrollermanuals
Understanding event and error messages	For information about the event and error messages generated by the system firmware and agents that monitor system components, go to qrl.dell.com > Look Up > Error Code , type the error code, and then click Look it up .	www.dell.com/qrl
Troubleshooting your system	For information about identifying and troubleshooting the PowerEdge server issues, see the Server Troubleshooting Guide.	www.dell.com/poweredgemanuals