

Dell PowerEdge MX760c

Technical Guide

Notes, cautions, and warnings

 **NOTE:** A NOTE indicates important information that helps you make better use of your product.

 **CAUTION:** A CAUTION indicates either potential damage to hardware or loss of data and tells you how to avoid the problem.

 **WARNING:** A WARNING indicates a potential for property damage, personal injury, or death.

Chapter 1: System overview	5
New technologies.....	5
System identification.....	5
Security features	6
Trusted Platform Module (TPM).....	6
Chapter 2: System features and generational comparison	7
Chapter 3: Chassis views and features	9
Chassis views.....	9
System configurations - front view for PowerEdge MX760c.....	9
System configurations - inside view for PowerEdge MX760c.....	12
System information label.....	15
Chapter 4: Processor	19
Processor features	19
Supported processors.....	19
Chipset.....	19
Chapter 5: Memory subsystem	20
DIMM types.....	20
Memory supported DIMMs.....	20
Memory RAS features.....	21
Chapter 6: Storage	22
Storage controllers.....	22
Chapter 7: Networking	23
Mezzanine Card Slot Priority Matrix.....	23
Chapter 8: PCIe	24
PCIe subsystem.....	24
Chapter 9: Power, thermal, and acoustics	26
Thermal.....	26
Thermal design.....	26
Thermal restriction matrix.....	27
Power.....	29
Power Supply.....	30
Acoustics.....	30
Acoustic Design.....	30
Acoustical Experience.....	32

Chapter 10: Operating Systems and Virtualization.....	34
Supported operating systems.....	34
Supported Virtualization.....	34
Chapter 11: Dell OpenManage Systems Management.....	35
Integrated Dell Remote Access Controller (iDRAC).....	35
Systems Management software support matrix.....	36
Chapter 12: Service and support.....	38
Default support levels.....	38
Default deployment levels.....	38
Other services and support information.....	38
Dell deployment services.....	38
Dell custom deployment Services.....	42
Dell Residency Services.....	42
Dell Data Migration Services.....	42
Dell Enterprise Support Services.....	43
Enterprise connectivity.....	45
Dell TechDirect.....	46
Dell Technologies Consulting Services.....	46
Chapter 13: Appendix A. Additional specifications.....	48
Sled dimensions.....	48
Sled weight.....	48
Video specifications.....	49
Environmental specifications.....	49
Thermal restriction matrix.....	50
Chapter 14: Appendix B: Standards compliance.....	53
Chapter 15: Appendix C Additional resources.....	54

System overview

Designed to run a variety of high-performance workloads, PowerEdge MX760c is the 2-socket modular server for the Dell PowerEdge MX infrastructure. This server features the Intel® Xeon® Scalable processor family, with up to 32 DIMMs, PCI Express® (PCIe) 5.0 enabled I/O slots, and a choice of high bandwidth Ethernet and Fiber Channel mezzanine cards.

Topics:

- [New technologies](#)
- [System identification](#)
- [Security features](#)

New technologies

Table 1. New Technologies featured on the MX760c

Technology	Detailed Description
Intel® Xeon® Scalable processors	Workload-optimized processors to support hybrid cloud infrastructures and the most high-demand applications.
4rd Generation Intel® Xeon® Scalable processors	<ul style="list-style-type: none"> • Up to 56 cores per socket • Up to 3.7 GHz • Up to 350 W for TDP (Please refer to processor restriction – Thermal Restriction Matrix) • Intel® Ultra Path Interconnect (UPI) up to 16 GT/s with up to four links between sockets • 7 nm process technology <p>Consult the processor section for specific SKUs offered</p>
Intel® C741 (Emmitsburg) Chipset	Intel® Platform Controller Hub (PCH) <ul style="list-style-type: none"> • Optional Intel® QuickAssist Technology (QAT)
DDR5 ECC memory up to 4800 MT/s (1 DPC) / 4400 MT/s (2 DPC)	8 DDR5 channels per socket, 2 DIMMs per channel (2DPC) <ul style="list-style-type: none"> • Up to 4800 MT/s (depending on configuration) • RDIMM <p>.Consult the memory section for specific details</p>
iDRAC9 with Lifecycle Controller	Works in conjunction with OpenManage Enterprise - Modular, embedded systems management solution for Dell servers' features hardware and firmware inventory and alerting, faster performance and many more features.

System identification

Each Dell system is assigned a unique BIOS ID, also referred to as a system ID.

Table 2. System identification

Platform codename	System ID
MX760c	0xA8A

Security features

The climate regarding security concerns has driven an enhanced approach to security features found in the PowerEdge server product line. Below is a table detailing physical features found in the MX760c that help ensure the security of the workloads supported by corporate infrastructure.

Table 3. Security features

Security Feature	Description
Cover Latch	A top cover latch is integrated in the top cover to secure it to the sled chassis
Trusted Platform Module (TPM)	The Trusted Platform Module (TPM) is used to generate/store keys, protect/authenticate passwords, and create/store digital certificates. Intel's TXT (Trusted Execution Technology) functionality along with Microsoft's Platform Assurance feature in Windows Server 2019/2022 is supported. TPM can also be used to enable the BitLocker™ hard drive encryption feature in Windows Server 2019/2022. Two versions of TPMs are supported in 16G namely TPM 2.0(Rest of World, aka everywhere excluding China and Russia) and TPM 2.0 China. No TPMs are supported for Russia in 16G.
Power-off Security	BIOS has the ability to disable the power button function to prevent someone from taking the server down.
Secure Boot Mode	BIOS has the ability to enter a secure boot mode through system setup. This mode includes the option to lock the power switches on the control panel or set up a system password.

Trusted Platform Module (TPM)

TPM is used to generate or store keys, protect or authenticate passwords, and create and store digital certificates.

TPM can also be used to enable the BitLocker™ hard drive encryption feature in Windows Server 2019/2022 and the Platform Assurance feature in Windows Server 2019.

TPM is enabled through a BIOS option and uses HMAC-SHA1-160 for binding. TPM is offered as Plug-In Module solution, the system board has a connector for a plug-in module.

TPM Module type has three options:

1. No TPM
2. TPM 2.0 FIPS + CommonCriteria+ TCG certified (Nuvoton)
3. TPM 2.0 China NationZ

System features and generational comparison

The following table shows the comparison between the PowerEdge MX760c with the PowerEdge MX750c:

Table 4. Features compared to previous version

Feature	PowerEdge MX760c	PowerEdge MX750c
Processor	Up to two 4rd Generation Intel® Xeon® Scalable Processors DIMM Speed: Up to 4800 MT/s Up to 56 cores per socket Max TDP: 350 W	Up to two 3rd Generation Intel® Xeon® Scalable Processors DIMM Speed: Up to 3200 MT/s Up to 40 cores per socket Max TDP: 270 W
Chipset	Intel® C741	Intel® C627A
Memory	32 DDR5 DIMM slots 32 slots for RDIMMs Maximum capacity (RDIMM): 16 TB	32 DDR4 DIMM slots 32 slots for RDIMMs and LRDIMMs Maximum capacity (RDIMM): 2 TB Maximum capacity (LRDIMM): 8 TB Intel Optane PMem 200 Series
Storage Controllers	S160 Software RAID H755 MX Performance RAID, NVMe RAID H965i MX Performance RAID, Performance RAID, SAS/SATA or NVMe RAID HBA350i MX	S150 Software RAID HBA350i MX H745P MX Performance RAID via PERC 10, internal and external drive connect, 8GB NV cache H755 Performance RAID, NVMe RAID HBA330 MX mini-mezz, HBA, external drive connect, no cache
Drive Support	2.5-inch 12 Gb SAS 2.5-inch NVMe 6 Gb SATA 8 x E3.S EDSFF NVMe SSD	2.5-inch 12 Gb SAS 2.5-inch 6 Gb SATA 2.5-inch NVMe
Drive Backplanes	4 x 2.5-inch SAS/SATA/NVMe (universal BP) 6 x 2.5-inch SAS/SATA 6 x 2.5-inch SATA/NVMe (universal BP) 8 x E3.S BP	6 x 2.5-inch SAS/SATA 6 x 2.5-inch SATA/NVMe (universal BP) 4 x 2.5-inch SAS/SATA/NVMe (universal BP)
Internal Boot	Choice of BOSS (Boot Optimized Storage Subsystem)	Choice of BOSS (Boot Optimized Storage Subsystem) or IDSDM (Internal Dual SD Module)
I/O Slots	One PCIe 4.0 x16 Mezz slots (Fabric A)	Two PCIe 4.0 x16 Mezz slots (Fabric A and B)

Table 4. Features compared to previous version (continued)

Feature	PowerEdge MX760c	PowerEdge MX750c
	<p>One PCIe 5.0 x16 Mezz slots (Fabric B)</p> <p>One PCIe 4.0 x16 Mini-mezz slot (Fabric C)</p> <p>One PCIe 4.0 x16 PERC slots</p> <p>One PCIe 4.0 x4 BOSS-N1</p>	<p>One PCIe 4.0 x16 Mini-mezz slot (Fabric C)</p>
USB	<p>One internal USB 3.0 port</p> <p>One front external USB 3.0 port</p> <p>One front USB 2.0 management port to iDRAC</p>	<p>One internal USB 3.0 port</p> <p>One external USB 3.0 port</p> <p>One USB 2.0 management port to iDRAC</p> <p>One USB 3.0 + USB 2.0 port for IDSDM</p>
Video	<p>Integrated VGA controller in iDRAC, VGA over LAN</p>	<p>Integrated VGA controller in iDRAC, VGA over LAN</p> <p>4 Gb DDR4 shared with iDRAC application memory</p>
Management	iDRAC9	iDRAC9
Security	<p>Optional TPM 2.0</p> <p>Secure Boot</p> <p>Power-off security</p>	<p>Optional TPM 1.2/2.0</p> <p>Cryptographically signed firmware</p> <p>Silicon Root of Trust</p> <p>Secure Boot</p> <p>System Lockdown</p> <p>System Erase</p>
Fans	In chassis Gen 2 fans	In chassis
Power Supplies	Power provided by chassis	Power provided by chassis
Chassis	MX7000	MX7000

Chassis views and features

Topics:

- Chassis views

Chassis views

System configurations - front view for PowerEdge MX760c

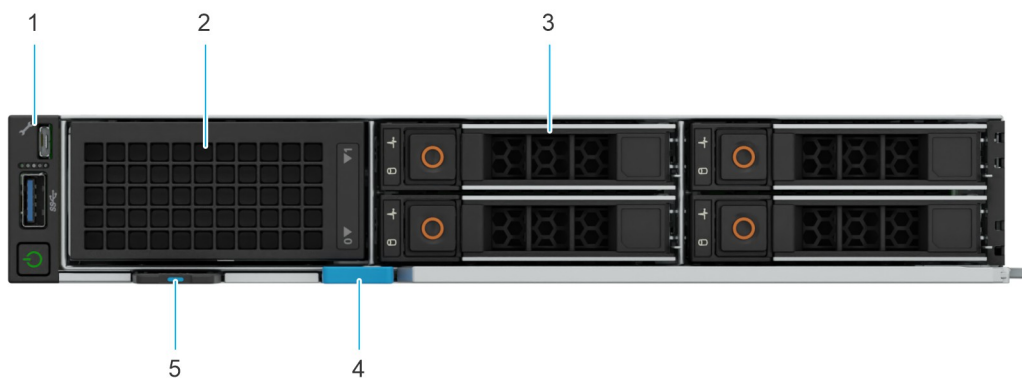

Figure 1. Front view of the 4 x 2.5-inch drive system

1. Front I/O module
2. Drive blank
3. Drives
4. Release handle
5. Express service tag

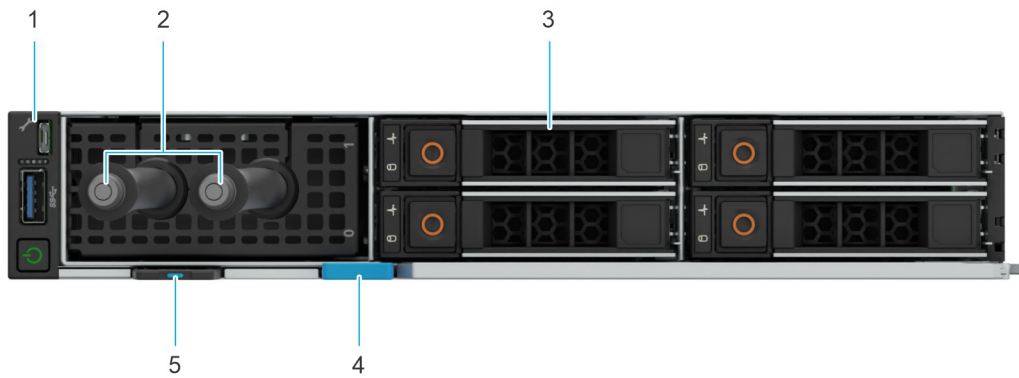

Figure 2. Front view of the 4 x 2.5-inch drive system with liquid cooling

- 1. Front I/O module
- 2. Liquid cooling tubes
- 3. Drives
- 4. Release handle
- 5. Express service tag



Figure 3. Front view of the 6 x 2.5-inch drive system

- 1. Front I/O module
- 2. Drives
- 3. Release handle
- 4. Express service tag

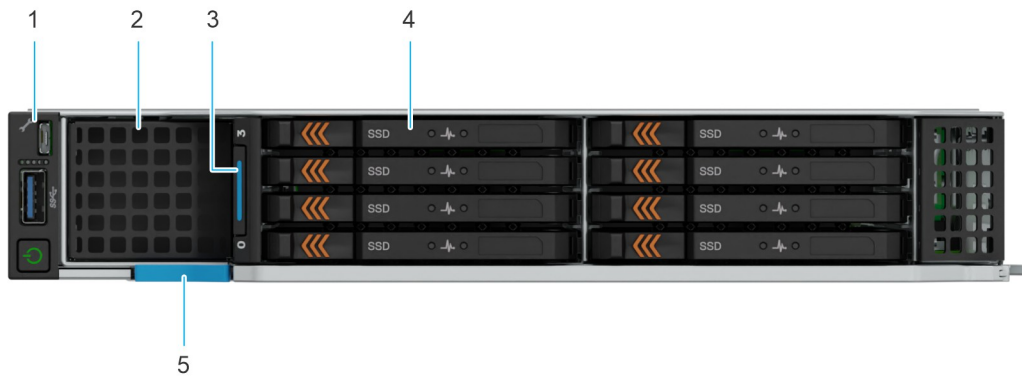

Figure 4. Front view of the 8 x E3.s drive system

- | | |
|------------------------|----------------|
| 1. Front I/O module | 2. Drive blank |
| 3. Express service tag | 4. Drives |
| 5. Release handle | |

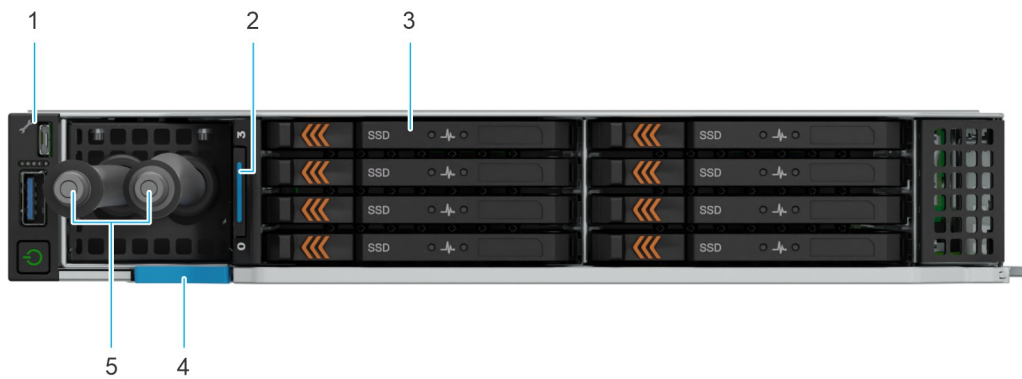

Figure 5. Front view of the 8 x E3.s drive system with liquid cooling

1. Front I/O module
2. Express service tag
3. Drives
4. Release handle
5. Liquid cooling tubes

Left control panel view

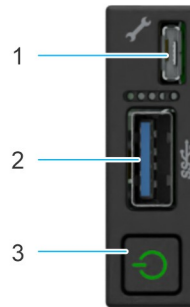

Figure 6. Front I/O module

1. iDRAC direct port
2. USB 3.0 port
3. Power button

System configurations - inside view for PowerEdge MX760c

NOTE: Components that are hot swappable have orange touch points and the components that are not hot swappable have blue touch points.

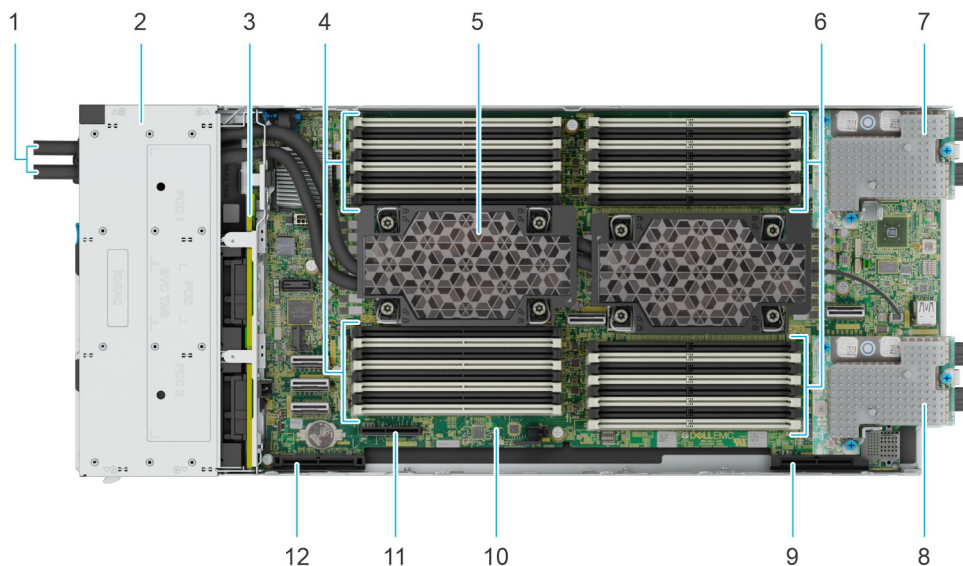

Figure 7. Inside the system (4 x 2.5-inch drive sled) with liquid cooling

1. Liquid cooling tubes
2. Drive cage
3. Backplane
4. Memory modules for Processor 1

- 5. Liquid cooling with Processor and heat sink module 1 and 2
- 6. Memory modules for Processor 2
- 7. Mezzanine card A
- 8. Mezzanine card B
- 9. Mini Mezzanine connector C
- 10. System board
- 11. BOSS-N1 (M.2)
- 12. PERC connector (H755 MX, H965i MX, HBA350i MX)

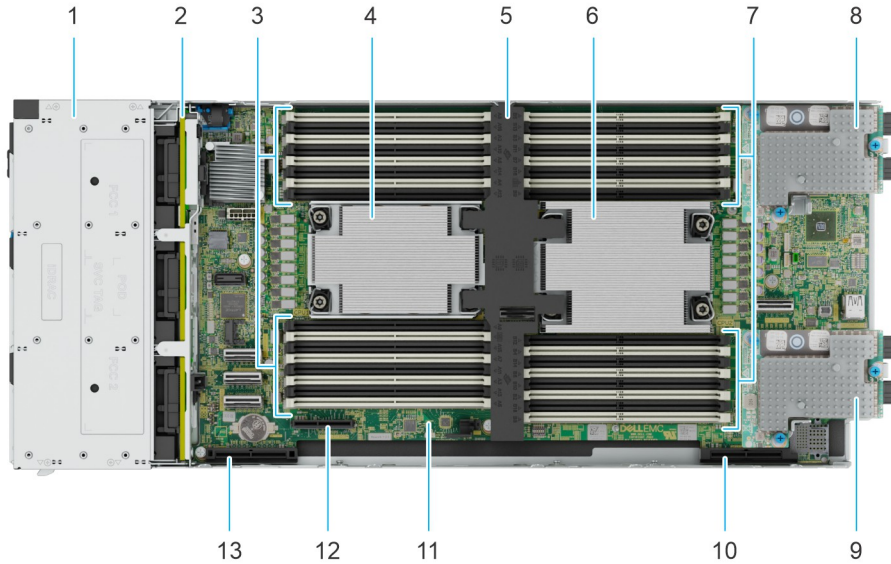

Figure 8. Inside the system (6 x 2.5-inch drive sled)

- | | |
|----------------------------------------------------|-------------------------------------|
| 1. Drive cage | 2. Backplane |
| 3. Memory modules for Processor 1 | 4. Processor and heat sink module 1 |
| 5. Air shroud | 6. Processor and heat sink module 2 |
| 7. Memory modules for Processor 2 | 8. Mezzanine card A |
| 9. Mezzanine card B | 10. Mini Mezzanine connector C |
| 11. System board | 12. BOSS-N1 (M.2) |
| 13. PERC connector (H755 MX, H965i MX, HBA350i MX) | |

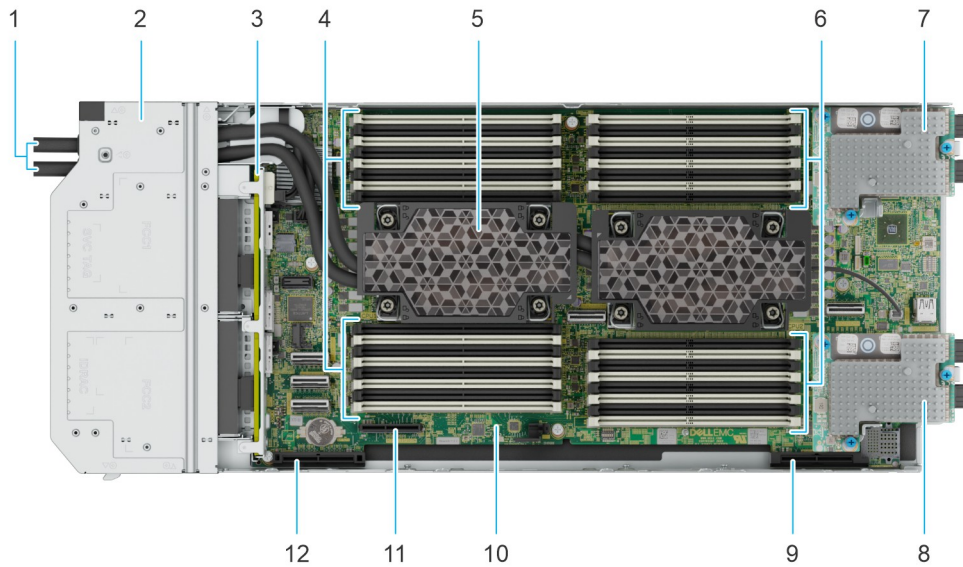

Figure 9. Inside the system (8 x E3.s drive sled) with liquid cooling

- | | |
|---------------------------------------------------------------|----------------------------------------------------|
| 1. Liquid cooling tubes | 2. Drive cage |
| 3. Backplane | 4. Memory modules for Processor 1 |
| 5. Liquid cooling with Processor and heat sink module 1 and 2 | 6. Memory modules for v 2 |
| 7. Mezzanine card A | 8. Mezzanine card B |
| 9. Mini Mezzanine connector C | 10. System board |
| 11. BOSS-N1 (M.2) | 12. PERC connector (H755 MX, H965i MX, HBA350i MX) |

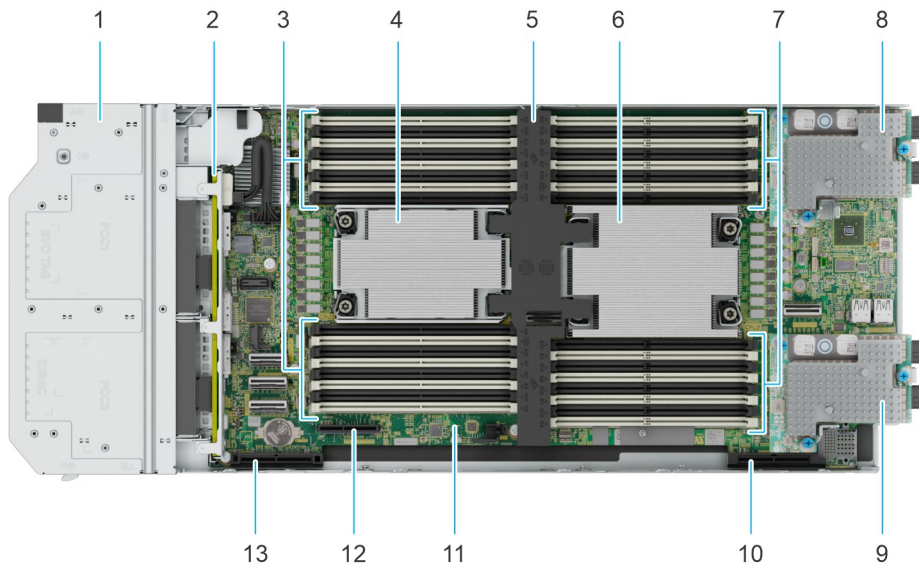

Figure 10. Inside the system (8 x E3.s drive sled)

- | | |
|-----------------------------------|-------------------------------------|
| 1. Drive cage | 2. Backplane |
| 3. Memory modules for Processor 1 | 4. Processor and heat sink module 1 |
| 5. Air shroud | 6. Processor and heat sink module 2 |
| 7. Memory modules for Processor 2 | 8. Mezzanine card A |

- 9. Mezzanine card B
- 11. System board
- 13. PERC connector (H755 MX, H965i MX, HBA350i MX)

- 10. Mini Mezzanine connector C
- 12. BOSS-N1 (M.2)

System information label

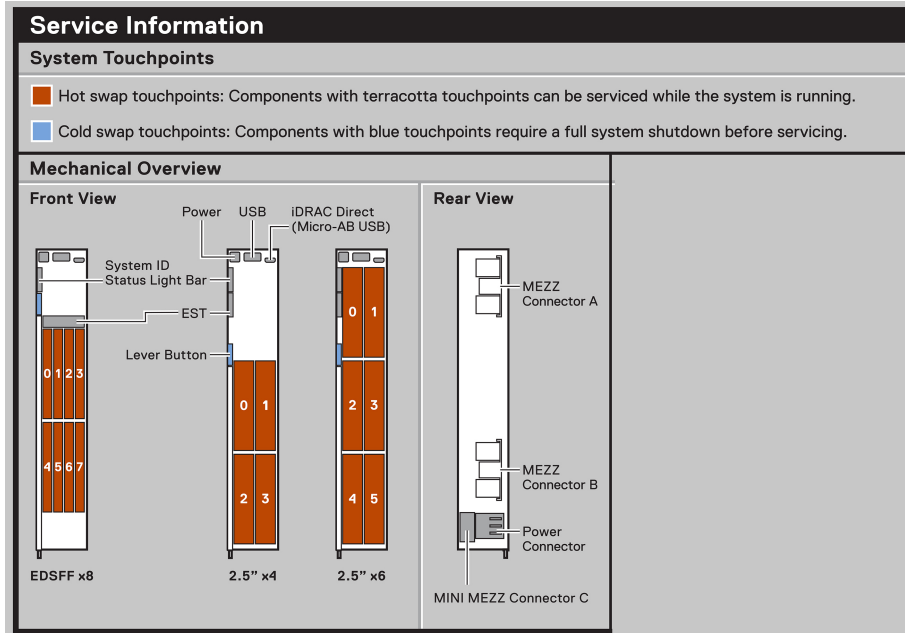

Figure 11. Mechanical overview

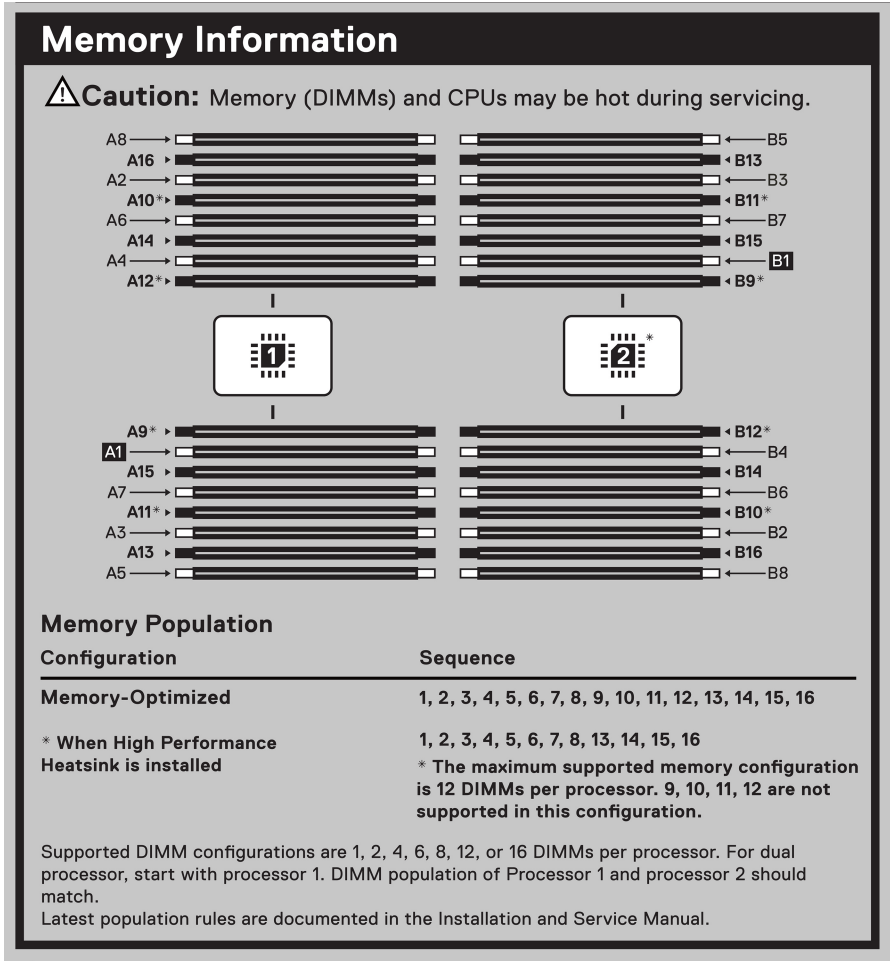

Figure 12. Memory overview

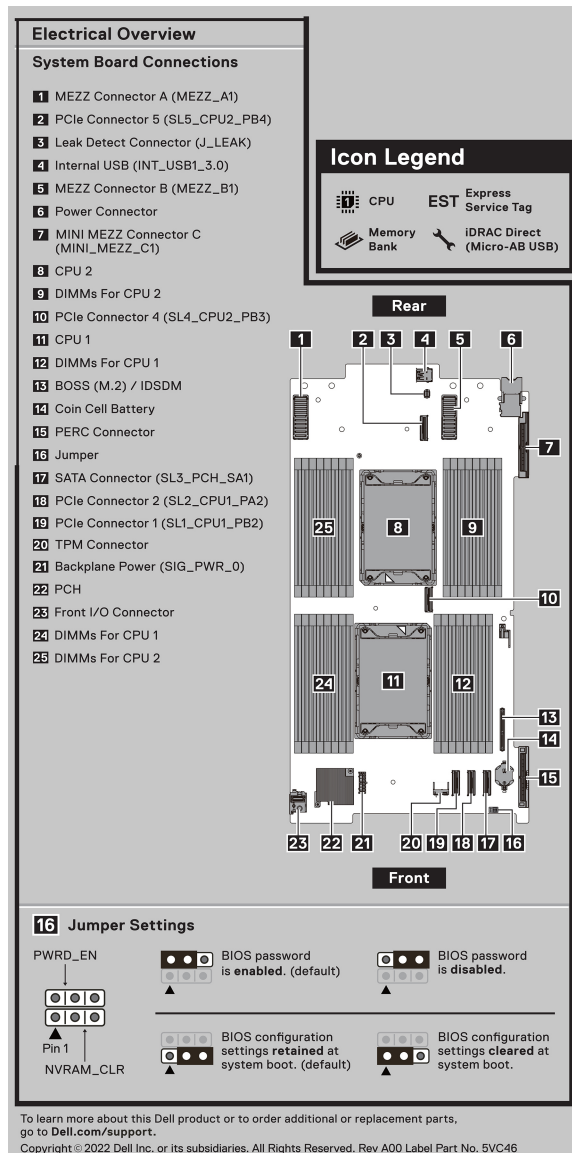

Figure 13. System board and jumper settings



Figure 14. Quick Resource Locator

⚠ Caution: Many repairs may only be done by a certified service technician. You should only perform troubleshooting and simple repairs as authorized in your product documentation, or as directed by the online or telephone service and support team. Damage due to servicing that is not authorized by Dell Technologies is not covered by your warranty. Read and follow the safety instructions that came with the product.

To learn more about this Dell product or to order additional or replacement parts, go to Dell.com/support.
Copyright © 2022 Dell Inc. or its subsidiaries. All Rights Reserved. Rev A00 Label Part No. 5VC46

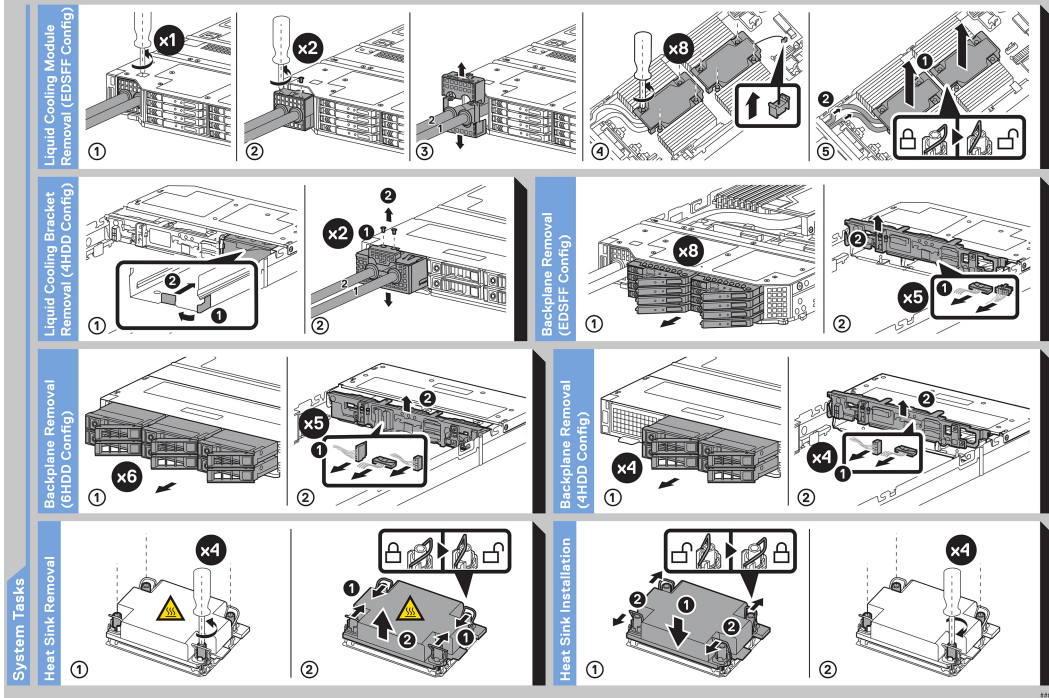

Figure 15. System tasks

Processor



Topics:

- [Processor features](#)
- [Supported processors](#)
- [Chipset](#)

Processor features

The 4th Generation Xeon Scalable Processors stack is a next generation data center CPU offering with the latest features, increased performance, and incremental memory options. This latest generation Xeon Scalable processor will support usages from entry designs based on Intel Xeon Silver processors to advanced capabilities offered in new Intel Xeon Platinum processor

The following lists the features and functions included in the upcoming 4th Generation Intel Xeon Scalable Processor offering:

- Faster UPI with up to four Intel Ultra Path Interconnect (Intel UPI) at 16 GT/s increasing multisocket bandwidth
- More, Faster I/O with PCI Express Gen 5 and up to 80 lanes (per socket) at 16 GT/s
- Enhanced Memory Performance with support for up to up to 4800 MT/s in one DIMM per channel (1DPC) and 4400 MT/s in two DIMM per channel (2DPC)
- Increased Memory Capacity with up to 8 channels and up to 256GB DDR5 DIMM support

Supported processors

Chipset

Intel® C741 (Emmitsburg) series Chipset Features

USB ports - up to three superspeed (USB 3.0)

Provide PCI-E Gen2 x1 to iDRAC- integrated VGA chip

one internal port to/from iDRAC (USB 2.0)

one internal port (USB 2.0/3.0)

six channels for SATA HDDs

· Integrated storage controllers

TPM Support - TPM 2.0

Memory subsystem

Topics:

- [DIMM types](#)
- [Memory supported DIMMs](#)
- [Memory RAS features](#)

DIMM types

The MX760c support only supports DDR5 registered DIMMs (RDIMMs) which use a buffer to reduce memory loading and provide greater density, allowing for maximum platform memory capacity.

Dell supports DDR5 RDIMM for MX760c:

- RDIMM: Registered DIMM – Provides for higher capacity options and advanced RAS features.

RDIMM , or registered memory, is the most commonly used DIMM type, and offers the best mix of frequency, capacity, and rank structure choices. It provides high signal integrity - performing parity checking to detect improper addresses or commands - and increased performance for heavy workloads.

RDIMMs (Single Rank and Dual Rank)

- Maximum frequency of 4800 MT/s (Depending on processor)
- Maximum frequency using 2 DIMMs per channel of 4400 MT/s
- Maximum capacity of 256GB per DIMM
- Maximum system capacity of 8 TB

Memory supported DIMMs

The following table lists the supported DIMMs for the MX760c at launch. For the latest information on supported DIMMS, refer to the [Memory NDA Deck](#). For specific memory configuration information, please refer to the User Manual.

Table 5. Supported DIMMs

DIMM PN	DIMM Speed	DIMM Type	DIMM Capacity (GB)	Ranks per DIMM	Data Width	DIMM Volts
1V1N1	4800	RDIMM	16GB	1R	8	1.1V
W08W9	4800	RDIMM	32GB	2R	8	1.1V
J52K5	4800	RDIMM	64GB	2R	8	1.1V
MMWR 9	4800	RDIMM	128GB	4R	4	1.1V
PCFCR	4800	RDIMM	256GB	8R	4	1.1V

The PowerEdge MX760c supports up to thirty-two RDIMMs with speeds up to 4800 MT/s with support for memory optimized operation.

Table 6. Memory specifications

DIMM type	DIMM rank	DIMM capacity	Single processor		Dual processors	
			Minimum system capacity	Maximum system capacity	Minimum system capacity	Maximum system capacity
RDIMM	Single rank	16 GB	16 GB	256 GB	32 GB	512 GB
	Dual rank	32 GB	32 GB	512 GB	64 GB	1 TB
		64 GB	64 GB	1 TB	128 GB	2 TB
	Quad rank	128 GB	128 GB	2 TB	256 GB	4 TB
	Octa Rank	256 GB	256 GB	4 TB	512 GB	8 TB

Memory RAS features

Reliability, Availability, and Serviceability (RAS) features help keep the system online and operational without significant impact to performance and can decrease data loss and failing due to errors. RAS aids in rapid, accurate diagnosis of faults which require service.

The following RAS features are supported on the platform:

Table 7. Supported RAS features

Feature	Description
Demand Scrubbing	Demand scrubbing is the ability to write corrected data back to the memory, once a correctable error is detected on a read transaction. This allows for correction of data in memory at the time of detection, and decreases the chances of a second error on the same address accumulating and causing a multi-bit error condition.
Patrol Scrubbing	<p>Patrol scrubbing pro-actively searches the system memory repairing correctable errors preventing accumulation of single-bit errors and turning it into an uncorrected error.</p> <p>Patrol scrubbing is accomplished using an engine that generates requests to memory addresses in a stride. The engine will generate a memory request at the Pre-programmed frequency, and the demand scrubbing flow corrects the error, if any.</p> <p>Patrol scrubbing finds opportunities on idle cycles to scrub the memory and get rid of any detectable correctable errors. Patrol scrubs are intended to ensure that data with a correctable error does not remain in DRAM long enough to stand a significant chance of further corruption to an uncorrectable error due to high energy particle error. The IMC will issue a Patrol Scrub at a rate sufficient to write every line once a day. For a maximum channel capacity of 192 GB, this would be one scrub every 26.8 micro-sec.</p> <p>The Patrol Scrub rate is configurable via 16b scrub interval timer.</p>
Permanent Fault Detection (PFD)	PFD is new with Sapphire Rapids processor. The logic determines if given fault from DIMM is confined to single device(Correctable), multi devices(Uncorrectable), or if the fault was transient. The ECC logic makes use of this information to correct the error from faulty DRAM device.

Storage

Topics:

- [Storage controllers](#)

Storage controllers

Dell's RAID controller options offer performance improvements, including the PERC9/10/11/12 solution. PERC provides a base RAID HW controller by using a small form factor and high-density connector to the base planar.

16G PERC Controller offerings will be a heavy leverage of 15G PERC family. The Value and Value Performance levels will carry over to 16G from 15G. New to 16G, is the Harpoon-based Premium Performance tier offering. This high-end offering will drive IOPs performance and enhanced SSD performances

Table 8. PERC Series controller offerings

Performance Level	Controller and Description
Entry	SW RAID, S160 (SATA, NVMe),
Value	HBA350i MX
Premium Performance	H755MX
	H965i MX

NOTE: For more information on the features of the Dell PowerEdge RAID controllers (PERC), Software RAID controllers, or BOSS card, and on deploying the cards, see the storage controller documentation at www.dell.com/storagecontrollermanuals.

Networking

Topics:

- Mezzanine Card Slot Priority Matrix

Mezzanine Card Slot Priority Matrix

Table 9. Mezzanine Card Slot Priority Matrix

Category	Card Priority	Description	Dell PNs	Width	Slot Priority	Max Cards	Planning Status
Ethernet Mezz	200	CRD,NTWK,BCME,MEZZ,25G,4P ,KR	DCWFP	x16	Mezzanine slot A or B (populate A first)	2	RTS Scope
	310	CRD,NTWK,INTL,MEZZ,25G,2P, MX	MR0H8	x8	Mezzanine slot A or B (populate A first)	2	RTS Scope
	300	CRD,NTWK,MEZ,DP,25,CNA,QL41262	51G0W	x8	Mezzanine slot A or B (populate A first)	2	RTS Scope

Topics:

- PCIe subsystem

PCIe subsystem

- One PCIe Gen4 x8 for PERC connected to processor 1 (CPU1).
- One x16 PCIe Gen4 slot for PERC – connected to processor 1
- One x16 PCIe Gen4 slot for Mezz A – connected to processor 1
- One x16 PCIe Gen5 slot for Mezz B – connected to processor 2
- One x16 PCIe Gen4 slot for Mini Mezz – connected to processor 1
- One x4 PCIe Gen4 slot for BOSS N1 – connected to processor 1

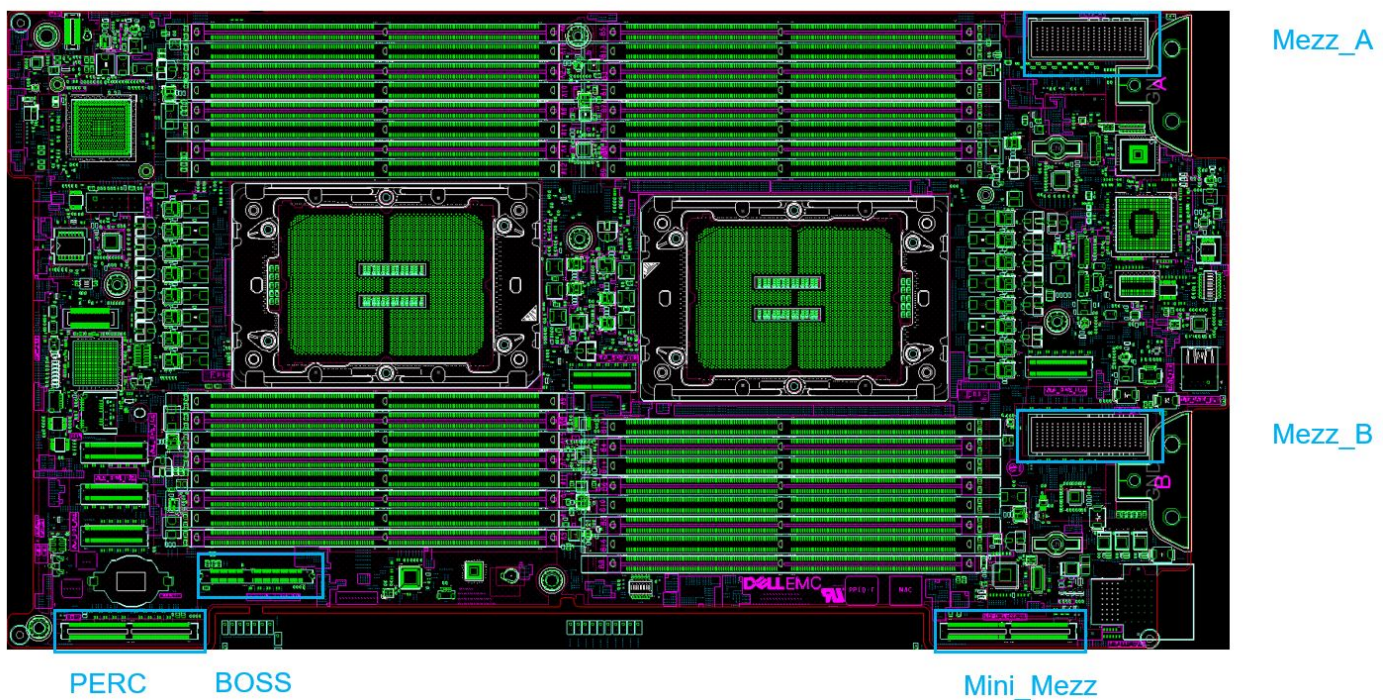
**Figure 16. MX760c PCIe Slots**

The following mezzanine and mini mezzanine cards are supported on the MX760c:

Table 10. Supported Fabric Adapters

Device	Fabric	Ports	Max Port Speed	Supported Fabric Slots	Data Sheet
Intel® XXV710 Dual Port 25 GbE Mezz Ethernet Adapter	Ethernet	2	25 Gb	Fabric A Fabric B	Info

Table 10. Supported Fabric Adapters (continued)

Device	Fabric	Ports	Max Port Speed	Supported Fabric Slots	Data Sheet
Broadcom PCIe Gen4 Quad-Port 25 GbE NIC	Ethernet	4	25 Gb	Fabric A Fabric B	Info
QLogic 41262 Dual Port 25 GbE Storage Offload Ethernet Mezz Adapter	Ethernet (CNA)	2	25 Gb	Fabric A Fabric B	Info
Emulex LPm32002 Dual Port FC32 Mini-Mezz Adapter	Fibre Channel	2	32 Gb	Fabric C	Info
QLogic 2742 Dual Port FC32 Mini-Mezz Adapter	Fibre Channel	2	32 Gb	Fabric C	Info
Dell PERC HBA350i MX Mezz Adapter	SAS	2	12 Gb	Fabric C	Info
Dell PERC HBA330 MX Mini-Mezz Adapter	SAS	2	12 Gb	Fabric C	Info

 **NOTE:** VMware ESXi 6.5 and 6.7 support a maximum of four 25 Gb Ethernet ports

Additional feature and specification information can be found in the [15G PowerEdge Server Adapter Matrix](#) on the [Dell Sales Portal](#).

Power, thermal, and acoustics

Topics:

- [Thermal](#)
- [Power](#)
- [Acoustics](#)

Thermal

Thermal management of the platform helps deliver high performance for the right amount of cooling to components at the lowest fan speeds across a wide range of ambient temperatures from -5°C to 55°C (23°F to 131°F) and to extended ambient temperature ranges (see [Environmental Specifications](#)). It might be reflected in lower overall power consumption (fans, platform, cooling/heating, data center power consumption, etc.) and greater acoustical versatility. PowerEdge servers have an extensive collection of sensors that automatically track thermal activity, which helps regulate temperature thereby reducing server noise and power consumption.

Thermal design

PowerEdge server cooling builds on the features and capability of previous Dell servers but expands support for higher power processors, PCIe cooling, and increased NVMe count.

A new chassis mechanical architecture enables increased airflow capability for cooling of higher power and dense system configurations and results in fewer system restrictions and increased feature density. Dell Server Thermal, Mechanical, and Thermal Control designs are based on the following key tenets and order of priority.

Table 11. PowerEdge thermal design tenets

Feature	Description
Reliability	<ul style="list-style-type: none"> • Component hardware reliability remains top thermal priority. • System thermal architectures and thermal control algorithms are designed to ensure there are no tradeoffs in system level hardware life.
Performance	<ul style="list-style-type: none"> • Performance and uptime are maximized through the development of cooling solutions that meet these needs of even the densest hardware configurations.
Efficiency	<ul style="list-style-type: none"> • PowerEdge servers are designed with an efficient thermal solution to maximize power and airflow consumption, and/or acoustics for acoustical deployments. • Dell's advanced thermal control algorithms enable minimization of system fan speeds while meeting reliability and performance tenets.
Management	<ul style="list-style-type: none"> • System management settings are provided such that customers have options to customize for their unique hardware, environments, and/or workloads
Forward Compatibility	<ul style="list-style-type: none"> • Forward compatibility means that thermal controls and thermal architecture solutions are robust to scale to new components that historically would have otherwise required firmware updates to ensure proper cooling.

Table 11. PowerEdge thermal design tenets (continued)

Feature	Description
	<ul style="list-style-type: none"> The frequency of required firmware updates is thus reduced.

PowerEdge servers have an extensive collection of sensors that automatically track thermal activity, which helps regulate temperature thereby reducing server noise and power consumption. The sensors in the MX760c interact with the chassis management services module which regulates fan speed. All fans which cool the MX760c are contained in the MX7000 chassis.

Thermal management of PowerEdge MX760c delivers high performance for the right amount of cooling to components at the lowest fan speeds across a wide range of ambient temperatures from 10°C to 35°C (50°F to 95°F) and to extended ambient temperature ranges (see [Environmental Specifications](#)). The benefits to you are lower fan power consumption (lower server system power and data center power consumption) and greater acoustical versatility.

For detailed information about thermals please consult the [MX7000 Sourcebook](#).

Thermal restriction matrix

Table 12. The PowerEdge MX760c thermal restriction matrix

Configuration			6 x 2.5-inch BP		6 x 2.5-inch BP		4 x 2.5-inch BP		8 x E3.s BP		Diskless in 4 x 2.5" BP	
Adjacent Sled Condition Support			Not Limited		Optimized*		Not Limited		Not Limited		Not Limited	
Front Storage Type			SAS drive	NVMe drive	SAS drive	NVMe drive	SAS drive	NVMe drive	E3 drive		No drive	
SPR XCC CPU	6430/645 4S	270W	Not Supported		35°C	35°C	35°C	35°C	35°C	35°C	35°C	35°C
	8461V	300W 1S	Not Supported		35°C	35°C	35°C	35°C	35°C	35°C	35°C	35°C
	8452Y/ 8460Y+	300W	Not Supported		Not Supported		30°C	30°C	30°C	30°C	35°C	35°C
	8468V	330W	Not Supported		Not Supported		Liquid Cooling Required		Liquid Cooling Required		Liquid Cooling Required	
	8468/848 0+/ 8470/847 0Q/8458P	350W	Not Supported		Not Supported		Liquid Cooling Required		Liquid Cooling Required		Liquid Cooling Required	
SPR MCC	3408U	125W 1S	45°C	45°C	45°C	45°C	45°C	45°C	45°C	45°C	45°C	45°C
	5416S	150W	45°C	45°C	45°C	45°C	45°C	45°C	45°C	45°C	45°C	45°C
	4416+	165W	45°C	45°C	45°C	45°C	45°C	45°C	45°C	45°C	45°C	45°C
	5418Y/ 6426Y	185W	40°C	40°C	40°C	40°C	40°C	40°C	40°C	40°C	40°C	40°C
	6434	195W	35°C	35°C	35°C	35°C	35°C	35°C	35°C	35°C	35°C	35°C
	5420+/ 6438Y+/ 6438M	205W	35°C	35°C	35°C	35°C	35°C	35°C	35°C	35°C	35°C	35°C
	6448Y/ 6442Y	225W	35°C	35°C	35°C	35°C	35°C	35°C	35°C	35°C	35°C	35°C
	6444Y	270W	Not Supported		35°C	35°C	35°C	35°C	35°C	35°C	35°C	35°C
8462Y+	300W	Not Supported		Not Supported		30°C	30°C	30°C	30°C	35°C	35°C	

Table 12. The PowerEdge MX760c thermal restriction matrix (continued)

Configuration			6 x 2.5-inch BP		6 x 2.5-inch BP		4 x 2.5-inch BP		8 x E3.s BP		Diskless in 4 x 2.5" BP	
Adjacent Sled Condition Support			Not Limited		Optimized*		Not Limited		Not Limited		Not Limited	
Front Storage Type			SAS drive	NVMe drive	SAS drive	NVMe drive	SAS drive	NVMe drive	E3 drive		No drive	
	6458Q	350W	Not Supported		Not Supported		Liquid Cooling Required		Liquid Cooling Required		Liquid Cooling Required	
Memory (System Is Air Cooled, No Liquid)	256 GB RDIMM 4800	13.2W, 2 DPC	30°C	30°C	30°C	30°C	35°C	35°C	35°C	35°C	35°C	35°C
	128 GB RDIMM 4800	9.7W, 2 DPC	35°C	35°C	35°C	35°C	35°C	35°C	35°C	35°C	35°C	35°C
	64 GB RDIMM 4800	8.5W, 2 DPC	45°C	45°C	45°C	45°C	45°C	45°C	45°C	45°C	45°C	45°C
	32 GB RDIMM 4800	4.2W, 2 DPC	45°C	45°C	45°C	45°C	45°C	45°C	45°C	45°C	45°C	45°C
PCI Card	Mezzanine card, Tier2, ≤ 30 W		45°C	45°C	45°C	45°C	45°C	45°C	45°C	45°C	45°C	45°C
	Mini Mezzanine card		45°C	45°C	45°C	45°C	45°C	45°C	45°C	45°C	45°C	45°C
Notes	<p>* Optimized sled condition is to recommend the nearby sleds population with same storage configuration or sled blank for thermally optimization by air cooling.</p> <p>** Wider HPR heatsink is required for > 225W CPUs</p> <p>*** Max DIMM count support for wider HPR heatsink is 24 pcs depended on DIMM population guidance.</p> <p>**** Liquid cooling solution can support all CPU SKUs, but is limited in 4 drives BP and E3.s BP configurations due to ME constrain</p>											

Extended ambient restrictions

ASHRAE A3 environment

- Do not perform a cold startup below 5°C
- The operating temperature specified is for a maximum altitude of 3050 m (10,000 ft).
- With Air Cooling Solution, Higher wattage processors, Thermal Design Power (TDP) > 185 W are not supported.
- With Liquid Cooling Solution, all processors are supported.
- Non-Dell qualified peripheral cards or peripheral cards greater than 30 W are not supported.
- PCIe SSD is not supported.
- 128 GB or higher capacity RDIMM is not supported.
- E3.s drive is not supported.

ASHRAE A4 environment

- Do not perform a cold startup below 5°C.
- The operating temperature specified is for a maximum altitude of 3050 m (10,000 ft).
- With Air Cooling Solution, Higher wattage processors, Thermal Design Power (TDP) > 165 W are not supported.
- With Liquid Cooling Solution, all processors are supported.

- Non-Dell qualified peripheral cards or peripheral cards greater than 30 W are not supported.
- PCIe SSD is not supported.
- 128 GB or higher capacity RDIMM is not supported.
- E3.s drive is not supported.

Power

Table 13. Power tools and technologies

Feature	Description
Power Supply Units(PSU) portfolio	Dell's PSU portfolio includes intelligent features such as dynamically optimizing efficiency while maintaining availability and redundancy. Find additional information in the Power supply units section.
Tools for right sizing	Enterprise Infrastructure Planning Tool (EIPT) is a tool that can help you determine the most efficient configuration possible. With Dell's EIPT, you can calculate the power consumption of your hardware, power infrastructure, and storage at a given workload. Learn more at www.dell.com/calc .
Industry Compliance	Dell's servers are compliant with all relevant industry certifications and guide lines, including 80 PLUS, Climate Savers and ENERGY STAR.
Power monitoring accuracy	PSU power monitoring improvements include: <ul style="list-style-type: none"> • Dell's power monitoring accuracy is currently 1%, whereas the industry standard is 5% • More accurate reporting of power • Better performance under a power cap
Power capping	Use Dell's systems management to set the power cap limit for your systems to limit the output of a PSU and reduce system power consumption. Dell is the first hardware vendor to leverage Intel Node Manager for circuit-breaker fast capping.
Systems Management	iDRAC Enterprise and Datacenter provides server-level management that monitors, reports and controls power consumption at the processor, memory and system level. Dell OpenManage Power Center delivers group power management at the rack, row, and data center level for servers, power distribution units, and uninterruptible power supplies.
Active power management	Intel Node Manager is an embedded technology that provides individual server-level power reporting and power limiting functionality. Dell offers a complete power management solution comprised of Intel Node Manager accessed through Dell iDRAC9 Datacenter and OpenManage Power Center that allows policy-based management of power and thermal at the individual server, rack, and data center level. Hot spare reduces power consumption of redundant power supplies. Thermal control off a speed optimizes the thermal settings for your environment to reduce fan consumption and lower system power consumption. Idle power enables Dell servers to run as efficiently when idle as when at full workload.
Fresh Air cooling	Refer to ASHRAE A3/A4 Thermal Restriction.
Rack infrastructure	Dell offers some of the industry's highest-efficiency power infrastructure solutions, including: <ul style="list-style-type: none"> • Power distribution units (PDUs) • Uninterruptible power supplies (UPSs) • Energy Smart containment rack enclosures Find additional information at: https://www.delltechnologies.com/en-us/servers/power-and-cooling.htm .

Power Supply

The MX760c obtains power from the MX7000 chassis which contains the power supplies. For detailed information about chassis power please consult the [MX7000 Sourcebook](#).

Acoustics

Acoustic Design

Acoustical Overview

Dell PowerEdge servers are designed to deliver an acoustical experience suitable for your environment and usage. Four design principles guide development to achieve this objective:

1. Sound power level and sound quality limits are appropriate for your environment and usage.
2. Sound quality should minimize tones and eliminate buzzes, rattles, and squeaks.
3. Transient response should be controlled to achieve rapid steady state convergence and prevent oscillation at steady state.
4. Thermal response should minimize air mover speed while meeting all component reliability requirements and system performance expectations.

Several acoustical metrics are measured and balanced to achieve the desired acoustical experience, including: Sound power level, sound pressure level, sound quality, and transient acoustical response. A-weighted sound power level and A-weighted sound pressure level are measures of the amplitude of sound. Comparisons of A-weighted sound pressure levels to some familiar noise sources are given in Acoustical reference points and output comparisons table for common reference.

Sound quality refers to psychoacoustical metrics that attempt to capture the human response to a sound associated with product health, annoyance, distraction, or pleasure. The presence of prominent tones, as defined in ECMA-74, is one example of a sound quality metric.

Transient response refers to changes with time; for example, response to CPU-intensive workload or when a system is turned on or off.

A reference for comparison to sound pressure levels and loudness for familiar noise sources is given in the table below.

Equivalent familiar noise experience	Value measured at your ears
	LpA (dBA re 20 µPa)
Loud concert	90
Data center, vacuum cleaner, voice must be elevated to be heard	75
Conversation levels	60
Whispering, open office layout, normal living room	45
Quiet office	35
Quiet library	30
Recording studio	20

Figure 17. Acoustical reference points and output comparisons

Tips for Acoustically Sensitive Environments

Thermal management and associated air mover speeds (re fans, blowers, etc) to cool components to comply with their specified limits are most responsible for sounds from computers. Amplitude of sound scales logarithmically with the speed of air movers, so a seemingly small speed adjustment can have surprisingly noticeable impacts, e.g., 10% speed change results approximately in 2 dB sound pressure level change while a 20% speed change results approximately in 5 dB sound pressure level change

With that in mind some common thermal drivers and tips to address them for acoustically sensitive environments are described in following table. Note that as ambient temperature, component power, and/or loading become sufficiently low that air movers are spinning at their minimum speed, other components may become audible. Examples are the hums from Hard Disk Drives and ringing from capacitors

Table 14. Thermal drivers and tips to address them for acoustically sensitive environments

Driver	Description	Tip
GPU / FPGA / Accelerator Cards	<ul style="list-style-type: none"> GPU, FPGA, or other accelerator cards often push the limits of power and cooling requirements in the PCI form factor. They may therefore require significantly higher air mover speeds and cause the host system to be much louder. During system boot up, air mover speeds may ramp (sometimes to full speed) to ensure the cards comply with their thermal limits at assumed worst case thermal state before thermal telemetry feedback is established in boot up. After boot up and telemetry feedback ascertains actual thermal conditions, air mover speeds may reduce 	If deemed an acceptable compromise to accommodate the environment, uninstalling the GPU or running it at a lower loading may reduce air mover speed and acoustical amplitude.
PCI Cards	Dell works diligently with card vendors to validate and develop PCI cards to meet Dell's exacting standards for thermal performance. Although Dell's products can look up and cool appropriately for a variety of cards, some 3 rd party cards may be unknown and thus air mover speed may be higher for thermal protection.	<ul style="list-style-type: none"> Replace third party PCI cards with similar Dell supported temperature-controlled cards, if available Set target in Third party PCIe card options: Dell provides airflow customization for third-party PCIe adapters installed in PowerEdge platforms. If automatic cooling response is above desired levels (LFM) based on the card specifications, a different LFM target can be set using PCIe Airflow Settings options in iDRAC GUI.
Storage Type	NVME SSD consumes more power than SAS/SATA drive technologies and therefore demands more airflow to achieve system cooling targets thus higher air mover speeds.	If deemed an acceptable compromise to accommodate the environment, replacing NVME SSD devices with SAS/SATA drives may reduce acoustical amplitude.
Thermal Design Power (TDP) System thermal profile selection in BIOS or iDRAC GUI	<p>Higher wattage components under load may require more airflow and thus higher air mover speeds and louder host system.</p> <ul style="list-style-type: none"> <i>Default Thermal Profile</i>, generally provides a lower air mover speed thus lower acoustical output than those of other thermal profiles. Maximum Performance (Performance Optimized) prioritizes performance above other aspects thus will more quickly increase air mover speed and be louder. Sound Cap or products that support the feature and when CPU cooling needs are dictating air mover speeds, can limit maximum acoustical output of the system by sacrificing some CPU performance. 	
BOSS-N1 module	If any BOSS-N1module is installed and "Maximum Performance (Performance Optimized)" is selected, air mover speed and acoustical noise may significantly increase at idle condition	
Ambient Temperature	ISO standards, ECMA standards, and Dell specs require acoustical tests in 23±2 °C ambient temperature. When ambient temperature is higher, air movers must speed up to compensate and thus generate more sound	

Standby Mode

In standby mode, one of the system air movers may continue to run at a low speed in order to provide cooling to components that are powered on when the system is plugged in and you may hear this sound.

Sound Cap

Sound cap is an iDRAC system profile which provides some system performance capping to achieve reduced acoustics without sacrificing reliability. When sound cap is enabled, acoustics are reduced at the expense of system performance. Designed for scenarios in which the server is redeployed from a data center into a noise-sensitive environment, Sound Cap results in limits to acoustical output by applying a power-capping percentage to the CPU(s). The power cap reduces heat generated by the CPUs during high utilization, which reduces fan speed needed for CPU cooling, which in turn reduces acoustical output.

Sound Cap may be useful in the following scenarios:

- Deployment of data center rack servers to quieter environments such as lab or office areas
- Equipment setup when hardware or software is being loaded.
- Equipment demonstrations or tours in which presenters wish to minimize fan noise from the server
- When limiting acoustics is consciously prioritized over CPU performance.

Sound Cap applies a percentage-based power cap to the CPU(s) in the server. Sound Cap can limit acoustical output, and it does not impact system cooling performance or any component thermal reliability. It also will not impact fan speeds in moderate CPU workloads or when the system is in idle state. Sound Cap should not be used or may be ineffective in the following scenarios:

- Benchmarking or performance-sensitive applications
- Reducing idle fan speeds or make a quiet server even quieter
- Using PCIe-based or VDI workloads

Additional Resources

For planning purposes, the Dell Enterprise Infrastructure Planning Tool (EIPT) may be used to predict Dell PowerEdge acoustical output based on a model that considers configuration, workload, and environmental inputs. Acoustical performance for previous Dell system may also be found online

Acoustical Experience

Dell PowerEdge MX760c is a blades data center server whose acoustical output ranges from that appropriate for data centers

Acoustical performance is provided in terms of three configurations: Quietest Entry, Typical and Quietest Feature Rich. Configuration details are provided in Acoustical configurations of MX760c table , and acoustical performance data associated with each configuration of MX760c is provided in Acoustical performance of MX760c acoustical configurations table. Each configuration has been tested according to Dell acoustical standards for blades data center servers.

Table 15. Acoustical configurations of MX760c

Configuration	Quietest Entry	Typical	Quietest Feature Rich
CPU Type	Intel	Intel	Intel
CPU TDP	150W	185W	195W
CPU Quantity	2 CPUs x 4 Slots	2 CPUs x 6 Slots	2 CPUs x 6 Slots
RDIMM Memory	16GB	16GB	32GB
Memory Quantity	12 x 4 Slot	16 x 6 Slot	24 x 6 Slot
Backplane Type	SAS/SATA	Universal	Universal
SSD Type	1600GB 12 Gb WI SAS SSD	2.5" NVMe direct	1600GB NVME
SSD Quantity	2 x 4 Slot	4 x 6 Slot	6 x 6 Slot
PSU Type	3000W	3000W	3000W

Table 15. Acoustical configurations of MX760c (continued)

Configuration	Quietest Entry	Typical	Quietest Feature Rich
PSU Quantity	6	6	6
Mezz 1	25Gb Mezz.	10/25Gb Mezz	25Gb Mezz
Mezz 2	N/A	10/25Gb Mezz	25Gb Mezz
BOSS Card	N/A	1	1
PERC	H740	H740P	H745P

Table 16. Acoustical performance of MX760c acoustical configurations

Configuration		Quietest Entry	Typical	Quietest Feature Rich
Acoustical Performance: Idle / Operating @ 25 °C Ambient				
L _{wA,m} (B)	Idle	6.3	6.9	7.0
	Operating	6.3	6.9	7.0
K _v (B)	Idle	0.4	0.4	0.4
	Operating	0.4	0.4	0.4
L _{pA,m} (dB)	Idle	52	57	59
	Operating	52	57	59
Prominent tones		No prominent tones in Idle and Operating		
Acoustical Performance: Idle @ 28 °C Ambient				
L _{wA,m} (B)		6.9	7.3	7.3
K _v (B)		0.4	0.4	0.4
L _{pA,m} (dB)		58	61	62
L _{wA,m} (B)		8.2	9.7	9.7
K _v (B)		0.4	0.4	0.4
L _{pA,m} (dB)		71	86	86

L_{wA,m} The declared mean A-weighted sound power level (L_{wA}) is calculated per section 5.2 of ISO 9296 with data collected using the methods described in ISO 7779. Data presented here may not be fully compliant with ISO 7779.

L_{pA,m} The declared mean A-weighted emission sound pressure level is at the bystander position per section 5.3 of ISO 9296 and measured using methods described in ISO 7779. The system is placed in a 24U rack enclosure, 25cm above a reflective floor. Engineering data presented here may not be fully compliant with ISO 7779 declaration requirements.

Prominent discrete tones: Criteria of Annex D of ECMA-74 & Prominence Ratio method of ECMA-418 are followed to determine if discrete tones are prominent and to report them, if so.

Idle mode: The steady-state condition in which the server is energized but not operating any intended function.

Operating mode: Operating mode is represented by the maximum of the steady state acoustical output at 50% of CPU TDP or active storage drives for the respective sections of Annex C of ECMA-74.

Operating Systems and Virtualization

Topics:

- [Supported operating systems](#)
- [Supported Virtualization](#)

Supported operating systems

The PowerEdge MX760c system supports the following operating systems:

- Canonical Ubuntu Server LTS
- Microsoft Windows Server with Hyper-V
- Red Hat Enterprise Linux
- SUSE Linux Enterprise Server
- VMware vSAN/ESXi

For more information, go to www.dell.com/ossupport.

Supported Virtualization

VMware vSphere (aka ESXi) is the virtualization software for workload consolidation from physical to virtualized environments.

The current version of ESXi is 7.0 U2 (March GA) and the previous major release is 6.7 U3 with patch. Both versions will support our 16G, 15G, 14G and most 13G volume servers. The certification requires that once a platform is added to VMware Compatibility Guide (VCG), there is continual sustaining certification when new VMware patches, updates, Dell driver, and firmware are updated.

The listing for the certification can be found at [here](#).

Dell OpenManage Systems Management

Dell delivers management solutions that help IT administrators effectively deploy, update, monitor, and manage IT assets. OpenManage solutions and tools enable you to quickly respond to problems by helping them to manage Dell servers efficiently; in physical, virtual, local, and remote environments; all without the need to install an agent in the operating system.

The OpenManage portfolio includes:

- Innovative embedded management tools - integrated Dell Remote Access Controller (iDRAC)
- Consoles - OpenManage Enterprise
- Extensible with plug-ins - OpenManage Power Manager
- Update tools - Repository Manager

Dell has developed comprehensive systems management solutions that are based on open standards and has integrated with management consoles from partners such as Microsoft and VMware, allowing advanced management of Dell servers. Dell management capabilities extend to offerings from the industry's top systems management vendors and frameworks such as Ansible, Splunk, and ServiceNow. OpenManage tools automate the full span of server life cycle management activities along with powerful RESTful APIs to script or integrate with your choice of frameworks.

For more information about the entire OpenManage portfolio, see:

- The latest [Dell Systems Management Overview Guide](#).

Topics:

- [Integrated Dell Remote Access Controller \(iDRAC\)](#)
- [Systems Management software support matrix](#)

Integrated Dell Remote Access Controller (iDRAC)

iDRAC9 delivers advanced, agent-free, local and remote server administration. Embedded in every PowerEdge server, iDRAC9 provides a secure means to automate a multitude of common management tasks. Because iDRAC is embedded within every PowerEdge server, there is no additional software to install; just plug in power and network cables, and iDRAC is ready to go. Even before installing an operating system (operating system) or hypervisor, IT administrators have a complete set of server management features at their fingertips.

With iDRAC9 in-place across the Dell PowerEdge portfolio, the same IT administration techniques and tools can be applied throughout. This consistent management platform allows easy scaling of PowerEdge servers as an organization's infrastructure grows. Customers can use the iDRAC RESTful API for the latest in scalable administration methods of PowerEdge servers. With this API, iDRAC enables support for the Redfish standard and enhances it with Dell extensions to optimize at-scale management of PowerEdge servers. By having iDRAC at the core, the entire OpenManage portfolio of Systems Management tools allows every customer to tailor an effective, affordable solution for any size environment.

Zero Touch Provisioning (ZTP) is embedded in iDRAC. ZTP - Zero Touch Provisioning is Intelligent Automation Dell's agent-free management puts IT administrators in control. Once a PowerEdge server is connected to power and networking, that system can be monitored and fully managed, whether you're standing in front of the server or remotely over a network. In fact, with no need for software agents, an IT administrator can: · Monitor · Manage · Update · Troubleshoot and remediate Dell servers With features like zero-touch deployment and provisioning, iDRAC Group Manager, and System Lockdown, iDRAC9 is purpose-built to make server administration quick and easy. For those customers whose existing management platform utilizes in-band management, Dell does provide iDRAC Service Module, a lightweight service that can interact with both iDRAC9 and the host operating system to support legacy management platforms.

When ordered with DHCP enabled from the factory, PowerEdge servers can be automatically configured when they are initially powered up and connected to your network. This process uses profile-based configurations that ensure each server is configured per your specifications. This feature requires an iDRAC Enterprise license.

iDRAC9 offers following license tiers:

Table 17. iDRAC9 license tiers

License	Description
iDRAC9 Basic	<ul style="list-style-type: none"> • Available only on 100-500 series rack/tower • Basic instrumentation with iDRAC web UI • For cost conscious customers that see limited value in management
iDRAC9 Express	<ul style="list-style-type: none"> • Default on 600+ series rack/tower, modular, and XR series • Includes all features of Basic • Expanded remote management and server life-cycle features
iDRAC9 Enterprise	<ul style="list-style-type: none"> • Available as an upsell on all servers • Includes all features of Basic and Express. Includes key features such as virtual console, AD/LDAP support, and more • Remote presence features with advanced, Enterprise-class, management capabilities
iDRAC9 Datacenter	<ul style="list-style-type: none"> • Available as an upsell on all servers • Includes all features of Basic, Express, and Enterprise. Includes key features such as telemetry streaming, Thermal Manage, automated certificate management, and more • Extended remote insight into server details, focused on high end server options, granular power, and thermal management

For a full list of iDRAC features by license tier, see [Integrated Dell Remote Access Controller 9 User's Guide](#) at [Dell.com](#).

For more details on iDRAC9 including white papers and videos, see:

- [Support for Integrated Dell Remote Access Controller 9 \(iDRAC9\)](#) on the [Knowledge Base](#) page at [Dell.com](#)

Systems Management software support matrix

Table 18. Systems Management software support matrix

Categories	Features	PE mainstream
Embedded Management and In-band Services	iDRAC9 (Express, Enterprise, and Datacenter licenses)	Supported
	OpenManage Mobile	Supported
	OM Server Administrator (OMSA)	Supported
	iDRAC Service Module (iSM)	Supported
	Driver Pack	Supported
Change Management	Update Tools (Repository Manager, DSU, Catalogs)	Supported
	Server Update Utility	Supported
	Lifecycle Controller Driver Pack	Supported
	Bootable ISO	Supported
Console and Plug-ins	OpenManage Enterprise	Supported
	Power Manager Plug-in	Supported
	Update Manager Plug-in	Supported
	SupportAssist Plug-in	Supported
	CloudIQ	Supported
Integrations and connections	OM Integration with VMware Vcenter/vROps	Supported
	OM Integration with Microsoft System Center (OMIMSC)	Supported
	Integrations with Microsoft System Center and Windows Admin Center (WAC)	Supported

Table 18. Systems Management software support matrix (continued)

Categories	Features	PE mainstream
	ServiceNow	Supported
	Ansible	Supported
	Third-party Connectors (Nagios, Tivoli, Microfocus)	Supported
Security	Secure Enterprise Key Management	Supported
	Secure Component Verification	Supported
Standard operating system	Red Hat Enterprise Linux, SUSE, Windows Server 2021 Ubuntu, CentOS	Supported (Tier-1)

Service and support

Topics:

- [Default support levels](#)
- [Other services and support information](#)

Default support levels

This system offers 3 years Dell ProSupport Plus Onsite 4 Hours, Mission Critical support, including 24x7 phone support and parts and labor.

Default deployment levels

Deployment of MX blades are included in the scope and price of PD/PDP for the MX7000 chassis. However, if customer is adding a standalone blade to an existing MX chassis suggest to sell ProDeploy which includes onsite hardware installation and remote software configuration. Optionally, the customer may choose any of the factory or field deployment offers listed below.

Other services and support information

Dell Technologies Services include a wide, customizable range of service options to simplify the assessment, design, implementation, management and maintenance of IT environments and to help transition from platform to platform.

Depending on the current business requirements and correct level of service for customers, we provide factory, onsite, remote, modular, and specialized services that fit the customer requirements and budget. We will help with a little or a lot, based on the customer's choice, and provide access to our global resources.

Dell deployment services

Dell ProDeploy Infrastructure Suite

ProDeploy Infrastructure Suite provides a variety of deployment offerings that satisfy a customer's unique needs. It is made up of 5 offers: ProDeploy Configuration Services, ProDeploy Rack Integration Services, Basic Deployment, ProDeploy, and ProDeploy Plus.

ProDeploy Infrastructure Suite for servers

Versatile choices for accelerated deployments

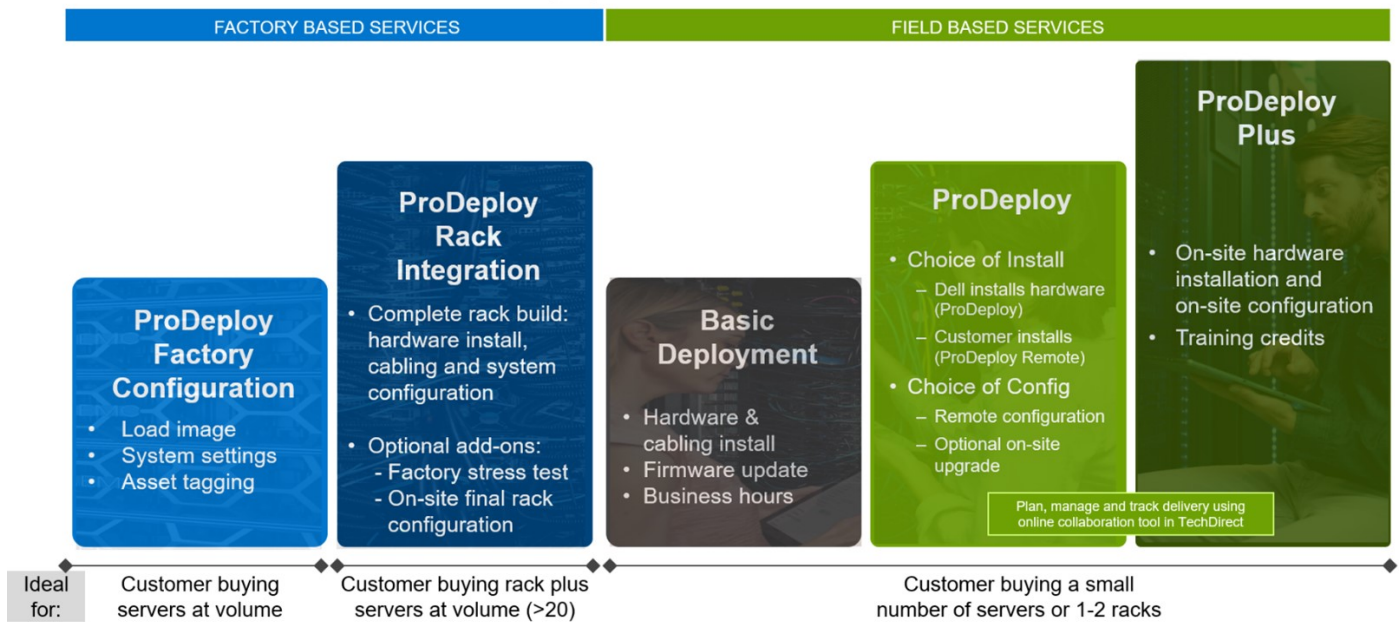

Figure 18. ProDeploy Infrastructure Suite for servers

The new Factory Services consist of two tiers of deployment that happen prior to shipping to the customer's site.

Factory Based Services:

- ProDeploy Factory Configuration - Ideal for customers buying servers in volume and seeking pre-configuration prior to shipping such as: custom image, system settings, and asset tagging so it arrives ready to use out of the box. Furthermore, servers can be packaged and bundled to meet specific shipping and distribution requirements for each customer location to facilitate the rollout process. Upsell one of the field based services (below) if a customer needs assistance with the final server installation.
- ProDeploy Rack Integration - Ideal for customers seeking to build out fully integrated racks prior to shipping. These rack builds include hardware install, cabling, and full system configuration. You can also add-on a factory stress test and optional on-site final rack configuration to complete the rack installation.
 - STANDARD SKUs for Rack Integration is available in US only and requires:
 - 20 or more devices (R and C series servers and all Dell or non-Dell switches). Use Informational SKUs for Dell switches or 3rd party products
 - Shipping to contiguous US
 - USE CUSTOM QUOTE for Rack Integration for:
 - All countries except USA
 - Racks containing less than 20 servers
 - Any rack that includes VxRail or Storage
 - Shipping outside contiguous US
 - Shipping to multiple locations

Field Based Services:

- Basic Deployment consists of the hardware installation, cabling and firmware update during normal standard business hours. Basic Deployment is traditionally sold to Competency Enabled Partners. Competency enabled partners often have Dell do the hardware installation while they complete the software configuration.
- ProDeploy consists of your hardware installation and configuration of the software using offshore resources. ProDeploy is great for customers who are price sensitive or who are remote from their data centers and don't require an onsite presence.
- ProDeploy Plus will give you in-region or onsite resources to complete the engagement for the customer. It also comes with additional features such as Post Deployment Configuration Assistance and Training Credits.

ProDeploy Infrastructure Suite | Factory services

FACTORY BASED SERVICES

		ProDeploy Factory Configuration	ProDeploy Rack Integration
Asset configuration	Single point of contact for project management	●	●
	RAID, BIOS and iDRAC configuration	●	●
	Firmware freeze	●	●
	Asset Tagging and Reporting	●	●
	Customer system image	●	●
Factory implementation	Site readiness review and implementation planning	-	●
	Hardware racking and cabling	-	●
	SAM engagement for ProSupport Plus entitled accounts/devices	-	●
	Deployment verification, documentation, and knowledge transfer	●	●
Delivery	White glove logistics	-	●
	Onsite final configuration	-	Onsite add-on
	Install support software and connect with Dell Technologies	-	Onsite add-on
	Basic Deployment	Optional onsite installation	-
Online oversight	Online collaborative environment for planning, managing and tracking delivery	-	●

¹ ProDeploy Rack Integration Services are currently only available within the United States. Custom rack integration services are still available globally.*

Dell Technologies

Figure 19. ProDeploy Infrastructure Suite - Factory services

ProDeploy Infrastructure Suite | Field services

		Basic Deployment	ProDeploy	ProDeploy Plus
Pre-deployment	Single point of contact for project management	●	●	In-region
	Site readiness review	-	●	●
	Implementation planning ¹	-	●	●
	SAM engagement for ProSupport Plus entitled devices	-	-	●
Deployment	Deployment service hours	Business hours	24x7	24x7
	Onsite hardware installation and packaging material removal ² or remote guidance for hardware installation ¹	●	Remote guidance or onsite	Onsite
	Install and configure system software	-	Remote	Onsite
	Install support software and connect with Dell Technologies	-	●	●
	Project documentation with knowledge transfer	-	●	●
Post-deployment	Deployment verification	-	●	●
	Configuration data transfer to Dell Technologies technical support	-	●	●
	30-days of post-deployment configuration assistance	-	-	●
	Training credits for Dell Technologies Education Services	-	-	●
Online oversight	Online collaborative environment in TechDirect for planning, managing and tracking delivery ³	-	●	●

¹ Remote option includes project specific instructions, documentation and live expert guidance for hardware installation. Option available for select hardware. [List is available in the backup portion of this customer presentation](#)

² Packaging removal included with onsite hardware installation

³ Included with ProDeploy or ProDeploy Plus, Not included with Basic Deployment

Figure 20. ProDeploy Infrastructure Suite - Field services

Dell ProDeploy Plus for Infrastructure

From beginning to end, ProDeploy Plus provides the skill and scale that is must successfully perform demanding deployments in today's complex IT environments. Certified Dell experts start with extensive environmental assessments and detailed migration

planning and recommendations. Software installation includes set up of our enterprise connectivity solution (secure connect gateway) and OpenManage system management utilities.

Postdeployment configuration assistance, testing, and product orientation services are also available.

Dell ProDeploy for Infrastructure

ProDeploy provides full-service installation and configuration of both server hardware and system software by certified deployment engineers including set up of leading operating systems and hypervisors as well our enterprise connectivity solution (secure connect gateway) and OpenManage system management utilities. To prepare for the deployment, we conduct a site readiness review and implementation planning exercise. System testing, validation, and full project documentation with knowledge transfer complete the process.

Dell Basic Deployment

Basic Deployment delivers worry-free professional installation by experienced technicians who know Dell servers inside and out.

Additional Deployment Services

You can tailor the ProDeploy Infrastructure Suite offer to meet your customer's unique needs by leveraging "Additional Deployment Time." ADT will cover additional tasks above the normal scope of the standard offers. ADT can be sold for Project Management or Technical Resources and is sold as blocks of four hours remote or eight hours on-site.

Dell ProDeploy for HPC (available in US/Canada only. All other regions use custom)

HPC deployments require specialists that understand that cutting edge is yesterday's news. Dell deploys the world 's fastest systems and understands the nuances that make them perform. ProDeploy for HPC provides:

- Global team of dedicated HPC specialists
- Proven track record, thousands of successful HPC deployments
- Design validation, benchmarking, and product orientation

Learn more at Dell.com/HPC-Services.

ProDeploy Expansion for HPC

*Available as standard SKUs in US & Canada and as custom quote in APJC, EMEA, LATAM

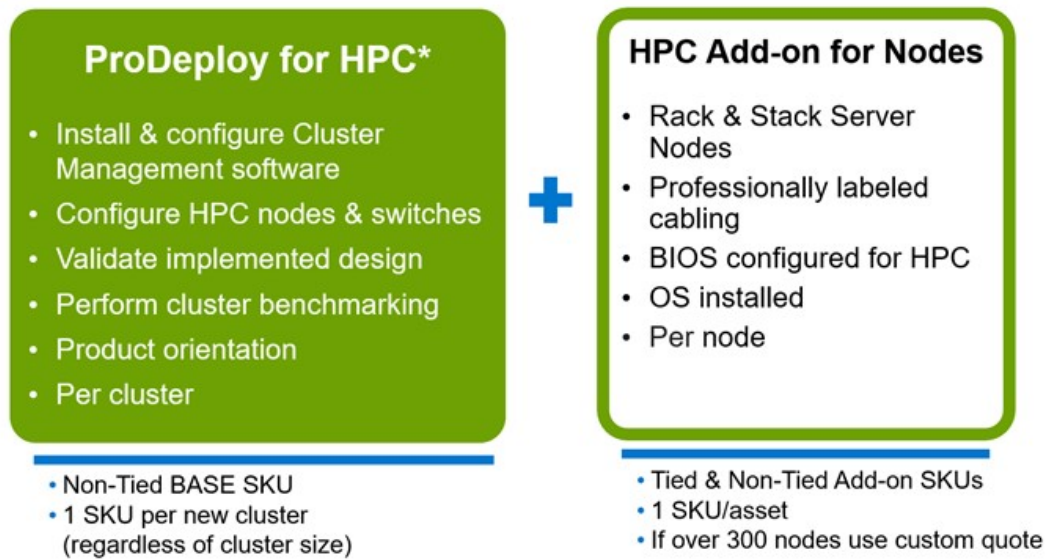

Figure 21. ProDeploy Expansion for HPC

Dell custom deployment Services

Dell custom rack integration and other Dell configuration services help customers save time by providing systems that are racked, cabled, tested, and ready to be integrated into the data center. Dell support preconfigure RAID, BIOS and iDRAC settings, install system images, and even install third-party hardware and software.

For more information, see [Server Configuration Services](#).

Dell Residency Services

Residency Services help customers transition to new capabilities quickly with the assistance of onsite or remote Dell experts whose priorities and time they control.

Residency experts can provide post implementation management and knowledge transfer that is related to a new technology acquisition or day-to-day operational management of the IT infrastructure.

Dell Data Migration Services

Protect business and data of the customer with our single point of contact to manage data migration projects.

A customer project manager works with our experienced team of experts to create a plan using industry-leading tools and proven processes that are based on global best practices to migrate existing files and data, so business systems are up and running quickly and smoothly.

Dell Enterprise Support Services

Dell ProSupport Enterprise Suite

With the ProSupport Enterprise Suite, we help keep IT systems running smoothly, so customers can focus on running their business. We help maintain peak performance and availability of the most essential workloads. ProSupport Enterprise Suite is a suite of support services that enable customers to build the solution that is right for their organization. They choose support models that are based on how they use technology and where they want to allocate resources. From the desktop to the data center, address everyday IT challenges, such as unplanned downtime, mission-critical needs, data and asset protection, support planning, resource allocation, software application management and more. Optimize customer IT resources by choosing the right support model.

Table 19. ProSupport Enterprise Suite

Service	Support model	Description
ProSupport Enterprise Suite	ProSupport Plus for Enterprise	Proactive, predictive, and reactive support for systems that look after your business-critical applications and workloads
	ProSupport for Enterprise	Comprehensive 24 x 7 support
	Basic hardware support	Reactive hardware support during normal business hours

Dell ProSupport Plus for Enterprise

When customers purchase PowerEdge server, we recommend ProSupport Plus, our proactive and preventative support service for business-critical systems. ProSupport Plus provides all the benefits of ProSupport, plus the following:

- An assigned Services Account Manager who knows their business and environment
- Immediate advanced troubleshooting from an engineer
- Personalized, preventive recommendations that are based on analysis of support trends and best practices from across the Dell Technologies infrastructure solutions customer base to reduce support issues and improve performance
- Predictive analysis for issue prevention and optimization that is enabled by secure connect gateway technology
- Proactive monitoring, issue detection, notification, and automated case creation for accelerated issue resolution enabled by secure connect gateway
- On-demand reporting and analytics-based recommendations that are enabled by secure connect gateway and TechDirect

Dell ProSupport for Enterprise

ProSupport service offers highly trained experts around the clock and around the globe to address IT needs. We help minimize disruptions and maximize availability of PowerEdge server workloads with:

- 24x7 support through phone, chat and online
- Predictive, automated tools and innovative technology
- A central point of accountability for all hardware and software issues
- Collaborative third-party support
- Hypervisor, operating system and application support
- Consistent experience regardless of where customers are located or what language they speak

 **NOTE:** Subject to service offer country or region availability.

- Optional onsite parts and labor response options including next business day or four-hour mission critical

ProSupport Enterprise Suite Feature Comparison

	Basic	ProSupport	ProSupport Plus
Remote technical support	9x5	24x7	24x7
Covered products	Hardware	Hardware Software	Hardware Software
Onsite hardware support	Next business day	Next business day or 4hr mission critical	Next business day or 4 hr mission critical
3 rd party collaborative assistance		●	●
Self-service case initiation and management		●	●
Access to software updates		●	●
Proactive storage health monitoring, predictive analytics and anomaly detection with CloudIQ and the CloudIQ mobile app		●	●
Priority access to specialized support experts			●
Predictive detection of hardware failures			●
3 rd party software support			●
An assigned Service Account Manager			●
Proactive, personalized assessments and recommendations			●
Proactive systems maintenance			●

Availability and terms of Dell Technologies Services vary by region and by product. For more information, please view our [service descriptions](#).

Internal Use - Confidential 23 of 117 © Copyright 2022 Dell Inc. DELL Technologies

Figure 22. ProSupport Enterprise Suite

Dell ProSupport One for Data Center

ProSupport One for Data Center offers flexible site-wide support for large and distributed data centers with more than 1,000 assets. This offering is built on standard ProSupport components that leverage our global scale but are tailored to a customer's needs. While not for everyone, this service option offers a truly unique solution for Dell Technologies largest customers with the most complex environments.

- Team of assigned Services Account Managers with remote, on-site options
- Assigned ProSupport One technical and field engineers who are trained on the customer's environment and configurations
- On-demand reporting and analytics-based recommendations that are enabled by secure connect gateway and TechDirect
- Flexible on-site support and parts options that fit their operational model
- A tailored support plan and training for their operations staff

Dell ProSupport Add-on for HPC

The ProSupport Add-on for HPC provides solution-aware support including:

- Access to senior HPC experts
- Advanced HPC cluster assistance: performance, interoperability, and configuration
- Enhanced HPC solution level end-to-end support
- Remote presupport engagement with HPC Specialists during ProDeploy implementation

Learn more at Dell.com/HPC-Services.

ProSupport Add-on for HPC is an add-on to PS or PSP

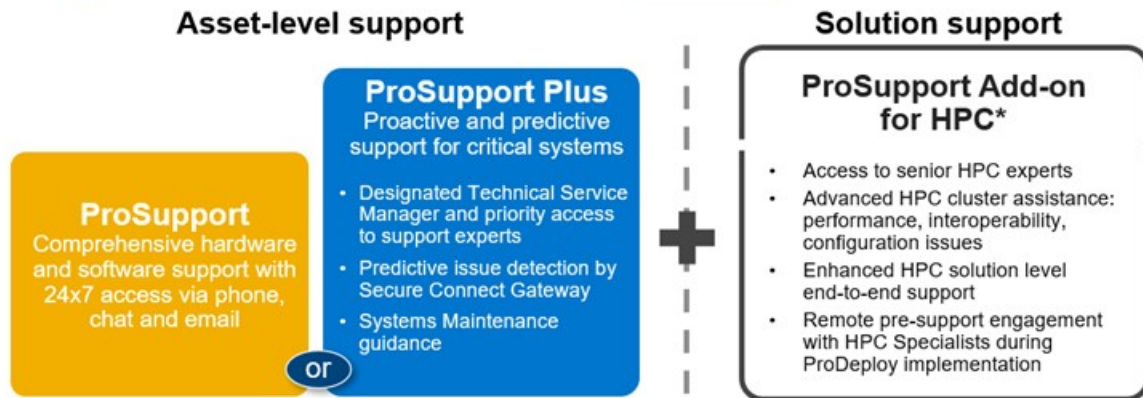

Eligibility

- All server, storage, and networking nodes in cluster must have PS or PSP **AND** PS Add-on for HPC attached
- All HW expansions to clusters must attach PS or PSP **AND** PS Add-on for HPC
- To retrofit an entire existing cluster with PS Add-on for HPC:
 1. HPC Specialists must review and validate the existing cluster
 2. PS or PSP **AND** the PS Add-on for HPC (APOS) must be attached to all server, storage and networking nodes

*Available in standard SKUs in NA and EMEA and as custom quote in APJC & LATAM

DELLTechnologies

Figure 23. ProSupport Add-on for HPC is an add-on to PS or PSP

Support Technologies

Powering the support experience with predictive, data-driven technologies.

NOTE: SupportAssist Enterprise capabilities are now part of the secure connect gateway technology.

Enterprise connectivity

The best time to solve a problem is before it happens. The automated proactive and predictive support features enabled by the secure connect gateway technology helps reduce steps and time to resolution, often detecting issues before they become a crisis. The gateway technology is available in virtual and application editions. It is also implemented as a direct connect version for select Dell hardware and a Services plugin within OpenManage Enterprise for PowerEdge servers. The legacy SupportAssist Enterprise solution has been retired and is now replaced by the secure connect gateway solutions.

Benefits include:

- Value: Our connectivity solutions are available to all customers at no additional charge
- Improve productivity: Replace manual, high-effort routines with automated support
- Accelerate time to resolution: Receive issue alerts, automatic case creation, and proactive contact from Dell experts
- Gain insight and control: Optimize enterprise devices with insights in portals reporting like TechDirect, and get predictive issue detection before the problem starts

NOTE: Connect devices can access these features. Features vary depending on the service level agreement for the connected device. ProSupport Plus customers experience the full set of automated support capabilities.

Table 20. Features enabled by connectivity

	Basic hardware warranty	ProSupport	ProSupport Plus
Automated issue detection and system state information collection	Supported	Supported	Supported
Proactive, automated case creation and notification	Not supported	Supported	Supported

Table 20. Features enabled by connectivity (continued)

	Basic hardware warranty	ProSupport	ProSupport Plus
Predictive issue detection for failure prevention	Not supported	Not supported	Supported

Get started at DellTechnologies.com/secureconnectgateway.

Dell TechDirect

TechDirect helps boost IT team productivity when supporting Dell systems.

Boost your productivity with online service for Dell products from TechDirect. From deployment to technical support, TechDirect lets you do more with less effort and faster resolution. You can:

- Open and manage support requests or in-warranty systems
- Execute online self-service for parts dispatch
- Collaborate on ProDeploy infrastructure deployment projects online
- Manage proactive and predictive alerts from secure connect gateway technology that help maximize uptime
- Integrate services functionality into your help desk with TechDirect APIs
- Join over 10,000 companies that choose TechDirect

Register at TechDirect.Dell.com.

Dell Technologies Consulting Services

Our expert consultants help customers transform faster, and quickly achieve business outcomes for the high value workloads Dell PowerEdge systems can handle. From strategy to full-scale implementation, Dell Technologies Consulting can help determine how to perform IT, workforce, or application transformation. We use prescriptive approaches and proven methodologies that are combined with portfolio and partner ecosystem of Dell Technologies to help achieve real business outcomes. From multi cloud, applications, DevOps, and infrastructure transformations, to business resiliency, data center modernization, analytics, workforce collaboration, and user experiences-we are here to help.

Dell Managed Services

Some customers prefer Dell to manage the complexity and risk of daily IT operations, Dell Managed Services utilizes proactive, AI enabled delivery operations and modern automation to help customers realize desired business outcomes from their infrastructure investments. With these technologies, our experts run, update and fine-tune customer environments aligned with service levels, while providing environment-wide and down-to-the-device visibility. There are two types of managed service offers. First the outsourcing model or CAPEX model where Dell manages the customer owned assets using our people and tools. The second is the as-a-Service model or OPEX model called APEX. In this service, Dell owns all technology and all the management of it. Many customers will have a blend of the two management types depending on the goals of the organization.

Managed	Outsourcing or CAPEX model	APEX	as-a-Service or OPEX model
<p>We manage your technology using our people and tools.¹</p> <ul style="list-style-type: none"> • Managed detection and response* • Technology Infrastructure • End-user (PC/desktop) • Service desk operations • Cloud Managed (Pub/Private) • Office365 or Microsoft Endpoint 		<p>We own all technology so you can off-load all IT decisions.</p> <ul style="list-style-type: none"> • APEX Cloud Services • APEX Flex on Demand elastic capacity • APEX Data Center Utility pay-per-use model 	

1 – Some minimum device counts may apply. Order via: ClientManagedServices.sales@dell.com

* Managed detection and response covers the security monitoring of laptops, servers, & virtual servers. Min. 50 devices combined. No Networking or Storage-only systems [SAN/NAS]. Available in 32 countries. [Details here](#)

Figure 24. Dell Managed Services

Dell Technologies Education Services

Build the IT skills required to influence the transformational outcomes of the business. Enable talent and empower teams with the right skills to lead and perform transformational strategy that drives competitive advantage. Leverage the training and certification required for real transformation.

Dell Technologies Education Services offers PowerEdge server training and certifications that are designed to help customers achieve more from their hardware investment. The curriculum delivers the information and the practical, firsthand skills that their team must confidently install, configure, manage, and troubleshoot Dell servers.

To learn more or register for a class today, see Education.Dell.com.

Appendix A. Additional specifications

Topics:

- Sled dimensions
- Sled weight
- Video specifications
- Environmental specifications

Sled dimensions

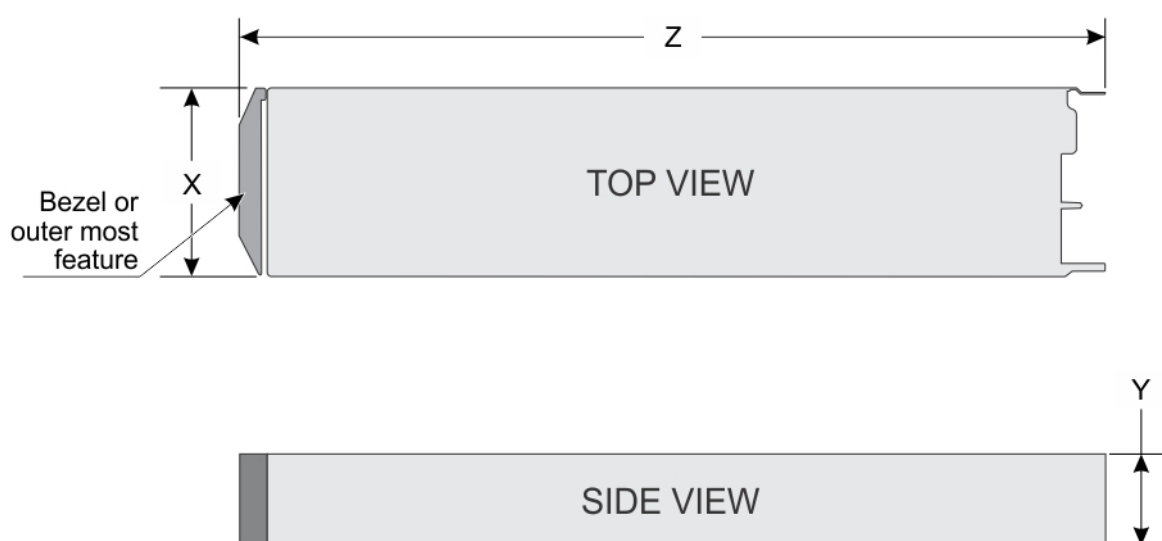

Figure 25. Sled dimensions

Table 21. PowerEdge MX760c sled dimensions

System configuration	X	Y	Z (handle closed).
4 x 2.5-inch or 6 x 2.5-inch	257.0 mm (10 inches)	51.0 mm (2 inches)	622.35 mm (24.5 inches)
8 x E3.s	257.0 mm (10 inches)	51.0 mm (2 inches)	631.77 mm (24.8 inches)

Sled weight

Table 22. PowerEdge MX760c sled weight

System configuration	Maximum weight (with all drives/SSDs)
4 x 2.5-inch	8.27 kg (18.23 pound)
6 x 2.5-inch	8.38 kg (18.47 pound)
8 x E3.s	8.59 kg (18.93 pound)

Video specifications

The PowerEdge MX760c system supports Matrox G200 W3 graphics controller integrated with iDRAC with 16 MB of video frame buffer.

Table 23. Supported video resolution options

Resolution	Refresh rate (Hz)	Color depth (bits)
1024 x 768	60	8, 16, 32
1280 x 800	60	8, 16, 32
1280 x 1024	60	8, 16, 32
1360 x 768	60	8, 16, 32
1400 x 900	60	8, 16, 32
1600 x 900	60	8, 16, 32
1600 x 1200	60	8, 16, 32
1680 x 1050	60	8, 16, 32
1920 x 1080	60	8, 16, 32
1920 x 1200	60	8, 16, 32

Environmental specifications

NOTE: For additional information about environmental certifications, refer to the *Product Environmental Datasheet* located with the *Documentation* on www.dell.com/support/home.

Table 24. Operational climatic range category A2

Temperature	Specifications
Allowable continuous operations	
Temperature ranges for altitudes <= 900 m (<= 2953 ft)	10–35°C (50–95°F) with no direct sunlight on the equipment
Humidity percent ranges (non-condensing at all times)	8% RH with -12°C minimum dew point to 80% RH with 21°C (69.8°F) maximum dew point
Operational altitude de-rating	Maximum temperature is reduced by 1°C/300 m (1.8°F/984 Ft) above 900 m (2953 Ft)

Table 25. Operational climatic range category A3

Temperature	Specifications
Allowable continuous operations	
Temperature ranges for altitudes <= 900 m (<= 2953 ft)	5–40°C (41–104°F) with no direct sunlight on the equipment
Humidity percent ranges (non-condensing at all times)	8% RH with -12°C minimum dew point to 85% RH with 24°C (75.2°F) maximum dew point
Operational altitude de-rating	Maximum temperature is reduced by 1°C/175 m (1.8°F/574 Ft) above 900 m (2953 Ft)

Table 26. Operational climatic range category A4

Temperature	Specifications
Allowable continuous operations	
Temperature ranges for altitudes <= 900 m (<= 2953 ft)	5–45°C (41–113°F) with no direct sunlight on the equipment
Humidity percent ranges (non-condensing at all times)	8% RH with -12°C minimum dew point to 90% RH with 24°C (75.2°F) maximum dew point
Operational altitude de-rating	Maximum temperature is reduced by 1°C/125 m (1.8°F/410 Ft) above 900 m (2953 Ft)

Table 27. Shared requirements across all categories

Temperature	Specifications
Allowable continuous operations	
Maximum temperature gradient (applies to both operation and non-operation)	20°C in an hour* (36°F in an hour) and 5°C in 15 minutes (9°F in 15 minutes), 5°C in an hour* (9°F in an hour) for tape <i>i</i> NOTE: * - Per ASHRAE thermal guidelines for tape hardware, these are not instantaneous rates of temperature change.
Non-operational temperature limits	-40 to 65°C (-40 to 149°F)
Non-operational humidity limits	5% to 95% RH with 27°C (80.6°F) maximum dew point
Maximum non-operational altitude	12,000 meters (39,370 feet)
Maximum operational altitude	3,050 meters (10,006 feet)

Table 28. Maximum vibration specifications

Maximum vibration	Specifications
Operating	0.26 G _{rms} at 5 Hz to 350 Hz (all operation orientations)
Storage	1.88 G _{rms} at 10 Hz to 500 Hz for 15 minutes (all six sides tested)

Table 29. Maximum shock pulse specifications

Maximum shock pulse	Specifications
Operating	Six consecutively executed shock pulses in the positive and negative x, y, and z axis of 6 G for up to 11 ms.
Storage	Six consecutively executed shock pulses in the positive and negative x, y, and z axis (one pulse on each side of the system) of 71 G for up to 2 ms.

Thermal restriction matrix

Table 30. The PowerEdge MX760c thermal restriction matrix

Configuration			6 x 2.5-inch BP	6 x 2.5-inch BP	4 x 2.5-inch BP	8 x E3.s BP	Diskless in 4 x 2.5" BP				
Adjacent Sled Condition Support			Not Limited	Optimized*	Not Limited	Not Limited	Not Limited				
Front Storage Type			SAS drive	NVMe drive	SAS drive	NVMe drive	SAS drive	NVMe drive	E3 drive	No drive	
SPR XCC CPU	6430/645 4S	270W	Not Supported		35°C	35°C	35°C	35°C	35°C	35°C	35°C
	8461V	300W 1S	Not Supported		35°C	35°C	35°C	35°C	35°C	35°C	35°C

Table 30. The PowerEdge MX760c thermal restriction matrix (continued)

Configuration			6 x 2.5-inch BP		6 x 2.5-inch BP		4 x 2.5-inch BP		8 x E3.s BP		Diskless in 4 x 2.5" BP	
Adjacent Sled Condition Support			Not Limited		Optimized*		Not Limited		Not Limited		Not Limited	
Front Storage Type			SAS drive	NVMe drive	SAS drive	NVMe drive	SAS drive	NVMe drive	E3 drive		No drive	
	8452Y/ 8460Y+	300W	Not Supported		Not Supported		30°C	30°C	30°C	30°C	35°C	35°C
	8468V	330W	Not Supported		Not Supported		Liquid Cooling Required		Liquid Cooling Required		Liquid Cooling Required	
	8468/8480+/ 8470/8470Q/8458P	350W	Not Supported		Not Supported		Liquid Cooling Required		Liquid Cooling Required		Liquid Cooling Required	
SPR MCC	3408U	125W 1S	45°C	45°C	45°C	45°C	45°C	45°C	45°C	45°C	45°C	45°C
	5416S	150W	45°C	45°C	45°C	45°C	45°C	45°C	45°C	45°C	45°C	45°C
	4416+	165W	45°C	45°C	45°C	45°C	45°C	45°C	45°C	45°C	45°C	45°C
	5418Y/ 6426Y	185W	40°C	40°C	40°C	40°C	40°C	40°C	40°C	40°C	40°C	40°C
	6434	195W	35°C	35°C	35°C	35°C	35°C	35°C	35°C	35°C	35°C	35°C
	5420+/ 6438Y+/ 6438M	205W	35°C	35°C	35°C	35°C	35°C	35°C	35°C	35°C	35°C	35°C
	6448Y/ 6442Y	225W	35°C	35°C	35°C	35°C	35°C	35°C	35°C	35°C	35°C	35°C
	6444Y	270W	Not Supported		35°C	35°C	35°C	35°C	35°C	35°C	35°C	35°C
	8462Y+	300W	Not Supported		Not Supported		30°C	30°C	30°C	30°C	35°C	35°C
	6458Q	350W	Not Supported		Not Supported		Liquid Cooling Required		Liquid Cooling Required		Liquid Cooling Required	
Memory (System Is Air Cooled, No Liquid)	256 GB RDIMM 4800	13.2W, 2 DPC	30°C	30°C	30°C	30°C	35°C	35°C	35°C	35°C	35°C	35°C
	128 GB RDIMM 4800	9.7W, 2 DPC	35°C	35°C	35°C	35°C	35°C	35°C	35°C	35°C	35°C	35°C
	64 GB RDIMM 4800	8.5W, 2 DPC	45°C	45°C	45°C	45°C	45°C	45°C	45°C	45°C	45°C	45°C
	32 GB RDIMM 4800	4.2W, 2 DPC	45°C	45°C	45°C	45°C	45°C	45°C	45°C	45°C	45°C	45°C
PCI Card	Mezzanine card, Tier2, ≤ 30 W		45°C	45°C	45°C	45°C	45°C	45°C	45°C	45°C	45°C	45°C
	Mini Mezzanine card		45°C	45°C	45°C	45°C	45°C	45°C	45°C	45°C	45°C	45°C
Notes	* Optimized sled condition is to recommend the nearby sleds population with same storage configuration or sled blank for thermally optimization by air cooling. ** Wider HPR heatsink is required for > 225W CPUs											

Table 30. The PowerEdge MX760c thermal restriction matrix (continued)

Configuration	6 x 2.5-inch BP		6 x 2.5-inch BP		4 x 2.5-inch BP		8 x E3.s BP	Diskless in 4 x 2.5" BP
Adjacent Sled Condition Support	Not Limited		Optimized*		Not Limited		Not Limited	Not Limited
Front Storage Type	SAS drive	NVMe drive	SAS drive	NVMe drive	SAS drive	NVMe drive	E3 drive	No drive
	*** Max DIMM count support for wider HPR heatsink is 24 pcs depended on DIMM population guidance. **** Liquid cooling solution can support all CPU SKUs, but is limited in 4 drives BP and E3.s BP configurations due to ME constrain							

Extended ambient restrictions

ASHRAE A3 environment

- Do not perform a cold startup below 5°C
- The operating temperature specified is for a maximum altitude of 3050 m (10,000 ft).
- With Air Cooling Solution, Higher wattage processors, Thermal Design Power (TDP) > 185 W are not supported.
- With Liquid Cooling Solution, all processors are supported.
- Non-Dell qualified peripheral cards or peripheral cards greater than 30 W are not supported.
- PCIe SSD is not supported.
- 128 GB or higher capacity RDIMM is not supported.
- E3.s drive is not supported.

ASHRAE A4 environment

- Do not perform a cold startup below 5°C.
- The operating temperature specified is for a maximum altitude of 3050 m (10,000 ft).
- With Air Cooling Solution, Higher wattage processors, Thermal Design Power (TDP) > 165 W are not supported.
- With Liquid Cooling Solution, all processors are supported.
- Non-Dell qualified peripheral cards or peripheral cards greater than 30 W are not supported.
- PCIe SSD is not supported.
- 128 GB or higher capacity RDIMM is not supported.
- E3.s drive is not supported.

Appendix B: Standards compliance

The system conforms to the following industry standards.

Table 31. Industry standard documents

Standard	URL for information and specifications
ACPI Advance Configuration and Power Interface Specification, v2.0c	https://uefi.org/specsandtesttools
Ethernet IEEE 802.3-2005	https://standards.ieee.org/
HDG Hardware Design Guide Version 3.0 for Microsoft Windows Server	microsoft.com/whdc/system/platform/pcdesign/desguide/serverdg.mspx
IPMI Intelligent Platform Management Interface, v2.0	intel.com/design/servers/ipmi
DDR5 Memory DDR5 SDRAM Specification	jedec.org/standards-documents/docs/jesd79-4.pdf
PCI Express PCI Express Base Specification Rev. 2.0 and 3.0	pcisig.com/specifications/pciexpress
PMBus Power System Management Protocol Specification, v1.2	http://pmbus.org/Assets/PDFS/Public/PMBus_Specification_Part_1_Rev_1-1_20070205.pdf
SAS Serial Attached SCSI, v1.1	http://www.t10.org/
SATA Serial ATA Rev. 2.6; SATA II, SATA 1.0a Extensions, Rev. 1.2	sata-io.org
SMBIOS System Management BIOS Reference Specification, v2.7	dmtf.org/standards/smbios
TPM Trusted Platform Module Specification, v1.2 and v2.0	trustedcomputinggroup.org
UEFI Unified Extensible Firmware Interface Specification, v2.1	uefi.org/specifications
USB Universal Serial Bus Specification, Rev. 2.7	usb.org/developers/docs

Appendix C Additional resources

Table 32. Additional resources

Resource	Description of contents	Location
Installation and Service Manual	This manual, available in PDF format, provides the following information: <ul style="list-style-type: none"> • Chassis features • System Setup program • System indicator codes • System BIOS • Remove and replace procedures • Diagnostics • Jumpers and connectors 	Dell.com/Support/Manuals
Getting Started Guide	This guide ships with the system, and is also available in PDF format. This guide provides the following information: <ul style="list-style-type: none"> • Initial setup steps 	Dell.com/Support/Manuals
Rack Installation Guide	This document ships with the rack kits, and provides instructions for installing a server in a rack.	Dell.com/Support/Manuals
System Information Label	The system information label documents the system board layout and system jumper settings. Text is minimized due to space limitations and translation considerations. The label size is standardized across platforms.	Inside the system chassis cover
Quick Resource Locator (QRL)	This code on the chassis can be scanned by a phone application to access additional information and resources for the server, including videos, reference materials, service tag information, and Dell contact information.	Inside the system chassis cover
Enterprise Infrastructure Planning Tool (EIPT)	The Dell online EIPT enables easier and more meaningful estimates to help you determine the most efficient configuration possible. Use EIPT to calculate the power consumption of your hardware, power infrastructure, and storage.	Dell.com/calc