

ASSEMBLING INSTRUCTION

HANGING CABINET WITH DRAWER

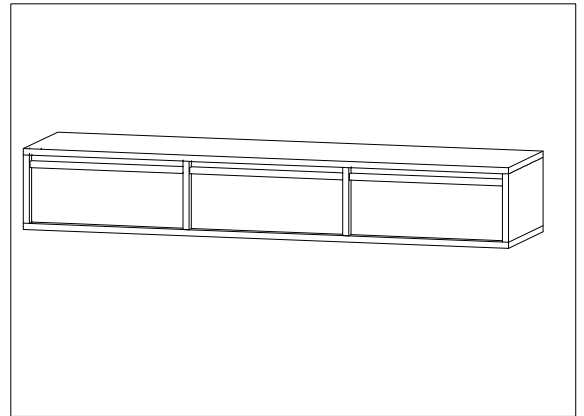

Pre Assembly :

- Please read all instructions before beginning assembly
- Place all parts on a carpet or foam in shipping box. Find the letter (A,B,C,...) on each part and check with below part list to ensure we have all components.
- Save all packing materials until assembly is complete to avoid accidentally discarding smaller parts or hardware.
- This cart requires one people to do assembly.

Parts Included :

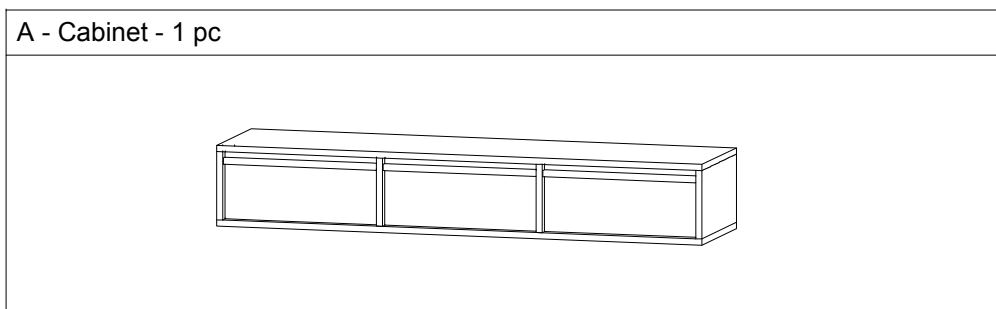

Hardware Enclosed:

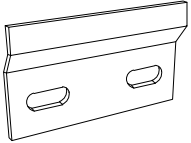
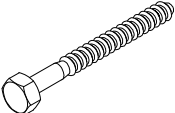
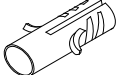
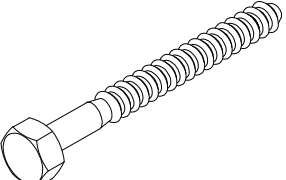
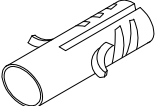
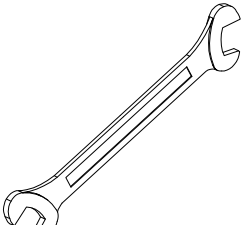
aa - Metal Support - 2 pcs	bb - Small Fischer Screw - 4 pcs	cc - Small Wall Plug - 4 pcs
		
dd - Big Fischer Screw - 3 pcs	ee - Big Wall Plug - 3 pcs	Wrench /Tool - not included
		

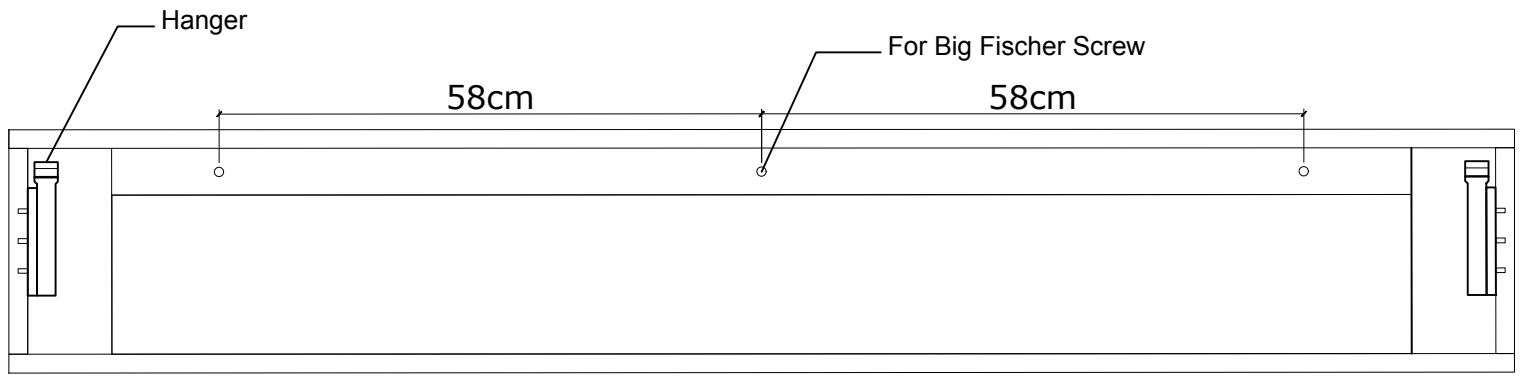

BACK VIEW

Assembly Instructions :

1. Lay Cabinet onto clean smooth surface as carpet or cardboard.
2. Drill the wall and insert the Small Wall Plugs (cc).
3. Fix Metal Support (aa) to the wall. Secured by Small Fischer Screw (bb).
Tighten by tool (not included)
4. Drill the wall and insert the Big Wall Plugs (ee).
5. Hang Cabinet (A) to the Metal Support (aa)

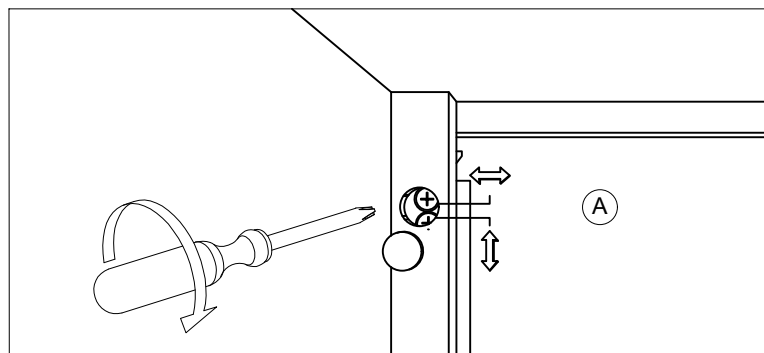
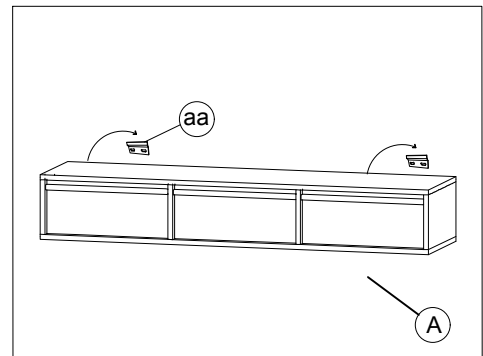
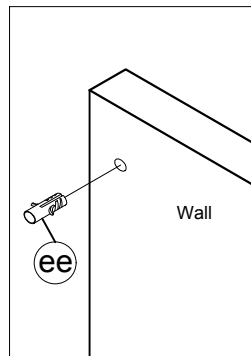
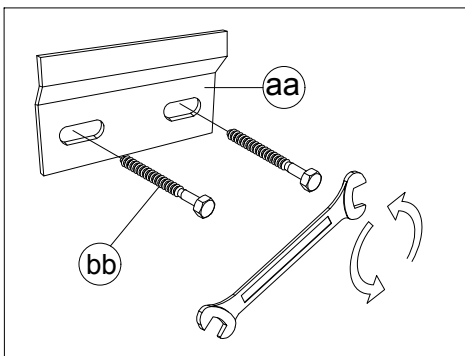
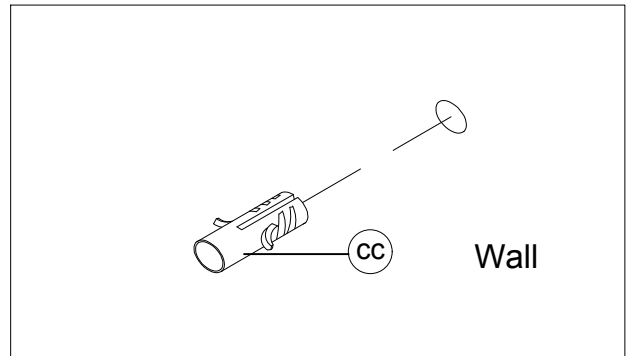
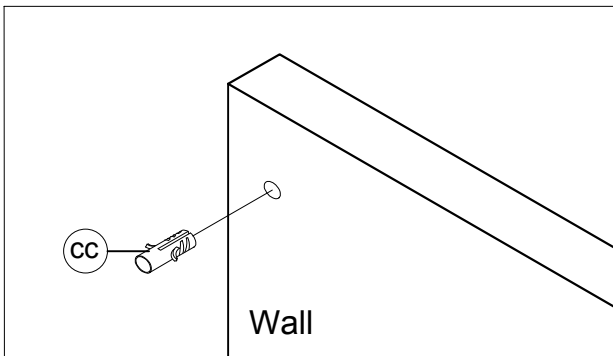

6. Fix Big Fischer Screw (dd) to the wall from back frame of inside cabinet (A).

Tighten by tool (not included).

7. Assembly is complete.

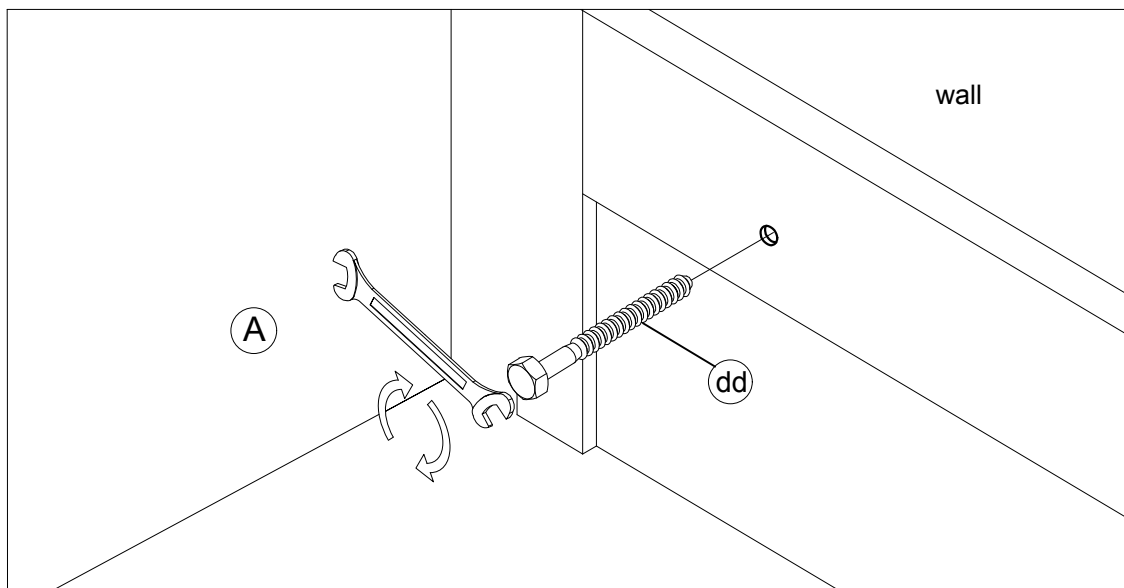
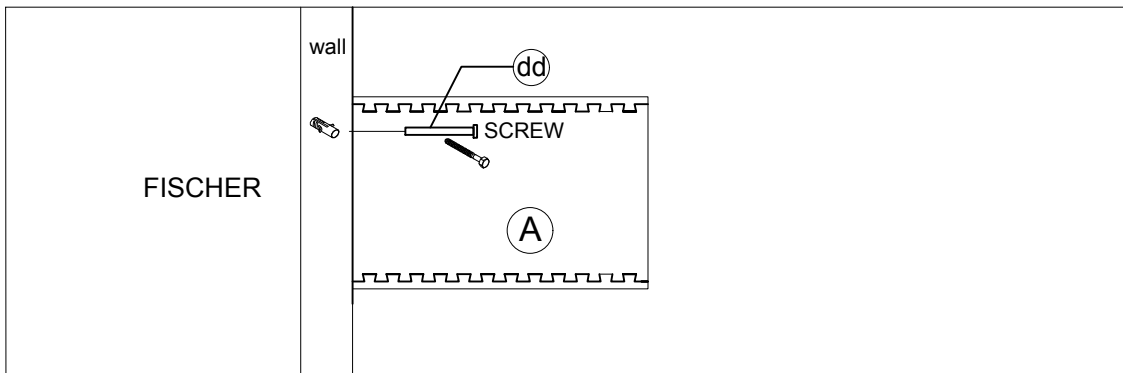

Care Instructions :

- Hardware may loosen over time. Periodically check to make sure all components are tight. Re-tighten if necessary.
- Dust with soft dry cloth.
- Avoid abrasive cleaners. If a cleaner is needed, use a mild-cleaner spray and blot with an absorbent cloth.
- For indoor use only.