

tala[®]

EU 

User Guide

DIMMER

Thoughtful lighting, responsibly designed in London.

Thank you for making the switch to Tala.

Discover the full Tala family at tala.co.uk

IMPORTANT

Please read the following instructions before commencing work, and keep for future reference.

Please take extreme care when carrying out the instructions detailed below.



Not suitable for non-dimmable LEDs.

WARNING

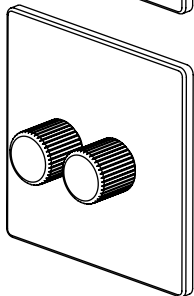
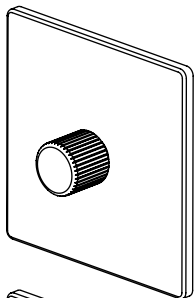
You must switch off electricity supply at the mains during installation and maintenance. We strongly recommend that you withdraw the fuse or switch off the circuit breaker while work is in progress. If in any doubt, please contact a qualified electrician.



COMPATIBLE LOADS

Dimmable LED		Load: 2-100W
Incandescent		1 Gang Load: 10-200W 2 Gang Load: 10-150W

SKU - ACC-DIM-SLG-GRAP-01-EU SKU - ACC-DIM-DBL-GRAP-01-EU

SKU - ACC-DIM-SLG-BRAS-01-EU SKU - ACC-DIM-DBL-BRAS-01-EU



This symbol  indicates that electrical and electronic equipment (WEEE) should not be mixed with general household waste. For recovery and recycling, please take this product to a designated collection point where it will be accepted free of charge. Many retailers offer this in-store. Disposing of this product correctly will help save valuable resources and prevent any potential negative effects on human health and the environment.

WIRING DIAGRAM - SINGLE MODULE

ONE-WAY OPERATION

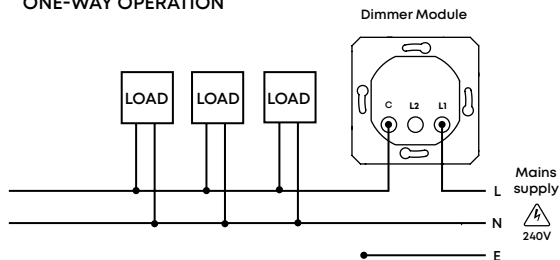

TWO-WAY OPERATION

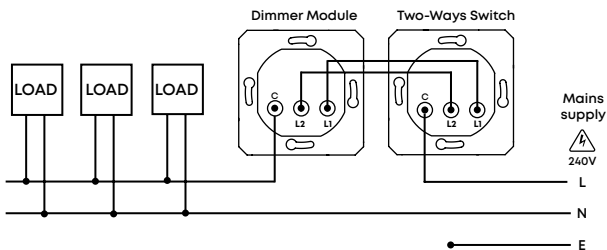

MIN BRIGHTNESS SETTING

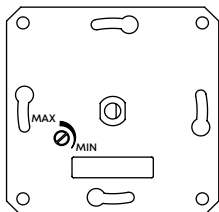

During wiring process, push the dial to turn the light ON. Turn dial clockwise to reach lowest brightness setting.

On the module, adjust the minimum brightness setting as required before final installation.

WIRING DIAGRAM - DOUBLE MODULE

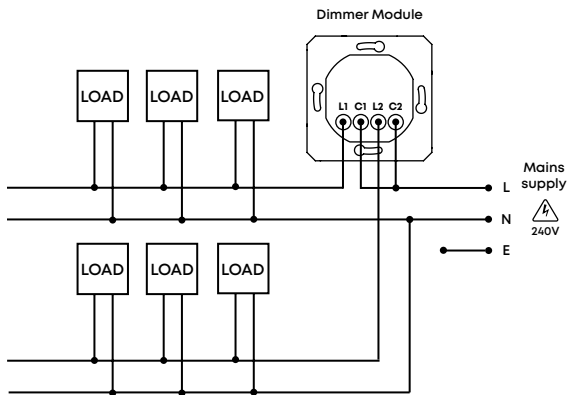

MIN BRIGHTNESS SETTING

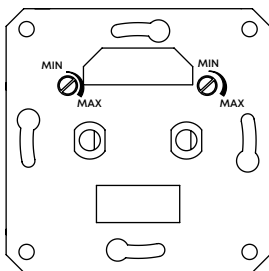

During wiring process, push the dial to turn the light ON. Turn dial anti-clockwise to reach lowest brightness setting.

On the module, adjust the minimum brightness setting as required before final installation.

FACE PLATE ASSEMBLY

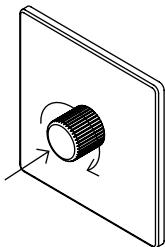
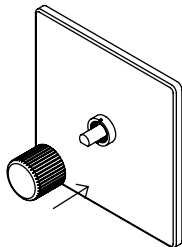
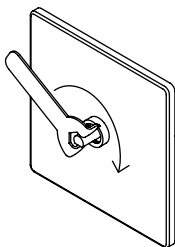
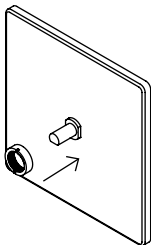
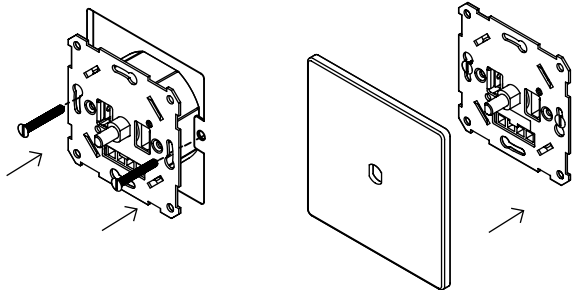

NORMAL OPERATION

Press the dimmer dial to the light ON or OFF.

Turn dial clockwise to increase brightness.

Turn dial anti-clockwise to decrease brightness.

Join the Community

Instagram: @tala | Facebook: talaHQ | Pinterest: TalaLED | Tag: lighttoliveby

Tala Studios, 25B Vyner Street, London E2 9DG | hello@tala.co.uk

Tala Europe B.V, Bertus Aafjeshove 40, Nieuwegein 3437JN, Netherlands