

## SCHOOL MILK COOLERS

MODEL:  MXMC34HC  MXMC49HC  MXMC58HC



MXMC34HC



MXMC49HC



MXMC58HC

Maxx Cold School Milk Coolers offer an efficient, low maintenance solution for milk crate cooling and storage. The cold wall construction delivers a consistent temperature range and stainless steel construction is durable and easy to clean.

### FEATURES AND CONSTRUCTION

- All stainless steel construction
- Equipped with four (4) 4" swivel casters (two with brakes)
- Solid state digital control system
- LED temperature display
- Urethane foam insulated walls and door
- Accommodates standard 13" x 13" x 11" or 19" x 13" x 11" crates

### STORAGE CAPACITY (13"W / 19"W Crates)

|                |         |
|----------------|---------|
| MXMC34HC ..... | 8 / 4   |
| MXMC49HC ..... | 12 / 8  |
| MXMC58HC ..... | 16 / 10 |

### TEMPERATURE

Holding temperature ..... 36°F to 38°F (2°C to 3°C)

- Solid-state controls and cold wall system deliver consistent, easily adjustable temperature performance

### ELECTRIC

115V / 60Hz / 1Ph  
 (230V / 50-60Hz / 1Ph is available as an option)  
 6' (2m) NEMA 5-15P cord set included

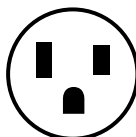

NEMA 5-15P

### 3RD PARTY APPROVALS



Intertek

Certified to ANSI NSF 7



Intertek

Certified to ANSI UL 471



Zero Ozone Depletion Potential



DOE 2017 Compliant

### MAXX COLD WARRANTY (USA / CANADA)

Contact Maxx Cold for warranty statement at  
 TechnicalServices@TheLegacyCompanies.com or 877.368.2797

FRONT VIEW

TOP VIEW

MXMC34HC

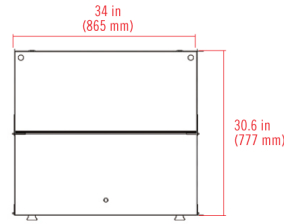
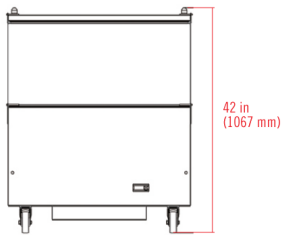

MXMC49HC

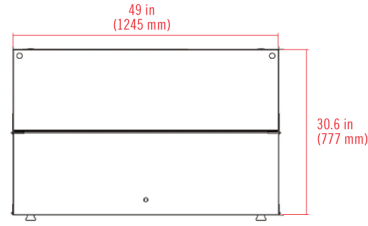
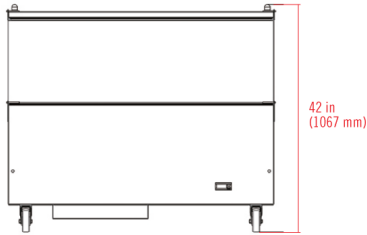

MXMC58HC

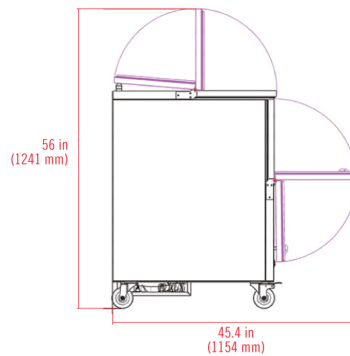
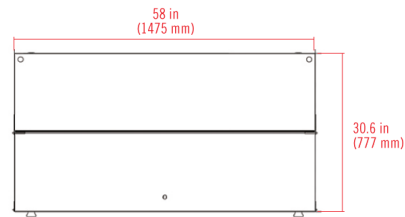
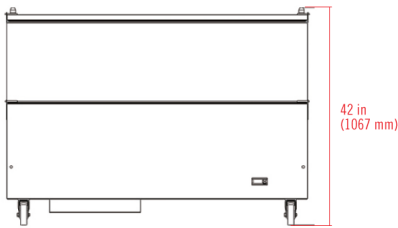

SIDE VIEW  
(ALL MODELS)

| MODEL    | EXTERNAL DIMENSIONS                         | CAPACITY<br>(13" X 13" X 11" CRATES) | CAPACITY<br>(19" X 13" X 11" CRATES) | HOLDING TEMPERATURE RANGE    | AMP DRAW | SHIPPING WEIGHT     | REFRIGERANT AND CHARGE SIZE | ELECTRICAL        |
|----------|---|--------------------------------------|--------------------------------------|------------------------------|----------|---------------------|-----------------------------|-------------------|
| MXMC34HC | 34" x 30.6" x 42"<br>(865 x 777 x 1067 mm)  | 8                                    | 4                                    | 36°F to 38°F<br>(2°C to 3°C) | 3.0A     | 220 lbs<br>(100 kg) | R-290a<br>3.17 oz (90 g)    | 115V / 60Hz / 1Ph |
| MXMC49HC | 49" x 30.6" x 42"<br>(1245 x 777 x 1067 mm) | 12                                   | 8                                    | 36°F to 38°F<br>(2°C to 3°C) | 3.0A     | 304 lbs<br>(140 kg) | R-290a<br>3.17 oz (90 g)    | 115V / 60Hz / 1Ph |
| MXMC58HC | 58" x 30.6" x 42"<br>(1475 x 777 x 1067 mm) | 16                                   | 10                                   | 36°F to 38°F<br>(2°C to 3°C) | 3.0A     | 430 lbs<br>(195 kg) | R-290a<br>3.17 oz (90 g)    | 115V / 60Hz / 1Ph |

### INSTALLATION

- A 2" clearance from the rear of the machine to the wall is recommended for proper air flow