

**MODEL: IMD-ERV15GD / IMD-ERV25GD
 IMD-ERV35GD**

BOTTLES COOLER: BLACK FINISH GLASS DOOR

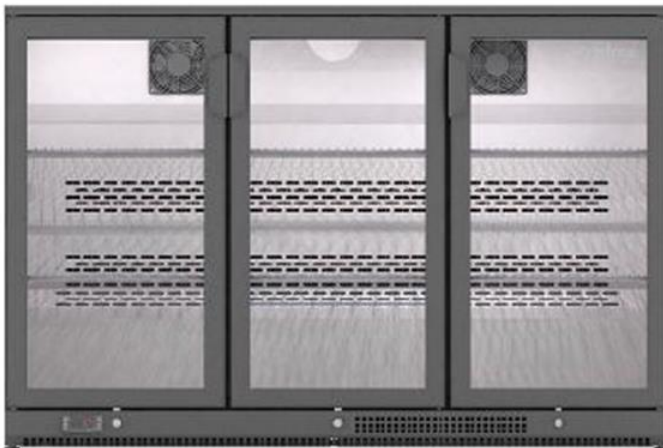

General Strengths

- ✓ **Sanitation.** Quick ability to take off shelves and slides for interior cleaning.
- ✓ **Doors.** All doors include door gaskets, easy to remove and snap in.
- ✓ **Control systems.** Higher precision in managing temperature settings. Greater ability for the adjustment of temperatures ranges as per the end user's requirement.
- ✓ **100% Tested.** All condenser units are tested 100%, in helium chambers for refrigerant leak detections.
- ✓ **Certified.** Audited and Certified by **INTERTEK** for compliance with UL 471 and NSF 7. EQA audited and certified by internationally recognized firm. ISO 9001:2015 (Quality); ISO 14001:2015 (Environmental); ISO 45001:2018 (Prevention and Worker Safety)
- ✓ **Lighting.** LED lighting in cabinet sides reduces the energy consumption by 80% and 90% compared to a traditional bulb. Provides a much better light quality.



STANDARD FEATURES

> Exterior

- Plastic-coated steel, black.
- Completely injected compact structure.
- Door lock.
- Leveling feet.

> Interior

- Interior grey plastic-coated steel.
- RGB LED lighting.

> Doors

- Double pane glass door.
- Triple chamber snap in door seals for easy removal.
- Black plastic handle included on the door.

OPTIONAL FEATURES

- ✓ Set of 2" Casters, front locking
- ✓ Electrical connection is 220-230 V / 1ph / 50Hz (plug type varies).
- ✓ Electrical connection is 220-230 V / 1ph / 60Hz (plug type varies).

> Insulation

- Polyurethane with high density 40kg/m³, CFSs free, zero ODP and low GWP.

> Shelving

- IMD-ERV15GD - (2) interior shelves.
- IMD-ERV25GD - (4) interior shelves.
- IMD-ERV35GD - (6) interior shelves.
- Guides and shelves easy to take off for cleaning.

> Refrigeration

- Temperature and defrost regulated by a digital controller.
- Forced air evaporation system.
- Forced air condensation system.
- Evaporative pan.
- Evaporator coil coated with anti-corrosion material.
- Refrigeration capacity:
IMD-ERV15GD - 1512 Btu/h (14°F) / **443W (-10°C)**
IMD-ERV25GD - 1512 Btu/h (14°F) / **443W (-10°C)**
IMD-ERV35GD - 1512 Btu/h (14°F) / **443W (-10°C)**

> Electrical

- Cord and NEMA 5-15P plug,
- Electrical connection is 115 V / 1ph / 60 Hz.



**MODEL: IMD-ERV15GD / IMD-ERV25GD
 IMD-ERV35GD**

BOTTLES COOLER: BLACK FINISH GLASS DOOR

MODELS	Dimensions (inches) (mm)			Doors	Shelves	Ref.	Ref. Weight (Lbs.) (gr.)	Temperature Range (°F) (°C)	Cond. Unit	Capacity (Cu.Ft.) (L)	Case Amps 115V	Crated weight (Lbs.) (Kg.)
	W	D	H									
IMD-ERV15GD	23-5/8 (600)	20-1/8 (510)	35-3/4 (907)	1	2	R290	0,17 (80)	39 °F/54 °F (+4°C/+12°C)	1/5	5 (124)	3,58	152 70
IMD-ERV25GD	35-3/8 (900)	20-1/8 (510)	35-3/4 (907)	2	4	R290	0,24 (110)	39 °F/54 °F (+4°C/+12°C)	1/5	8 (193)	3,89	202 92
IMD-ERV35GD	53-1/8 (1350)	20-1/8 (510)	35-3/4 (907)	3	6	R290	0,24 (110)	39 °F/54 °F (+4°C/+12°C)	1/3	11,6 (296)	3,90	284 129

ELEVATION

RIGHT VIEW

PLANT VIEW

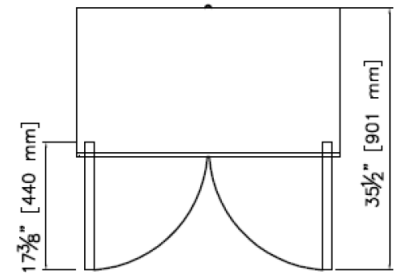
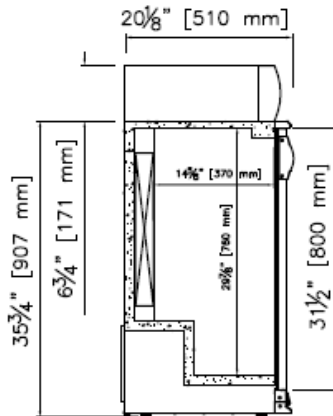
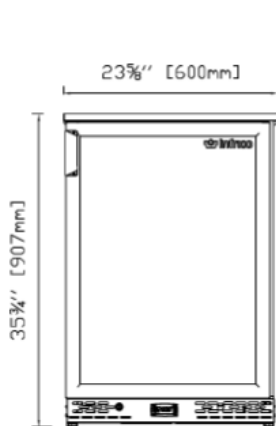

IMD-ERV15GD

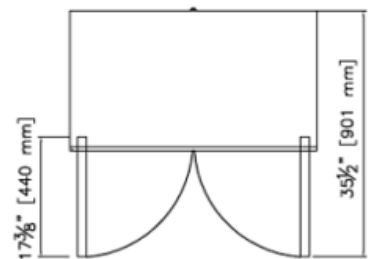
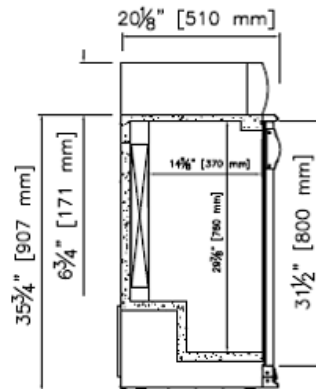
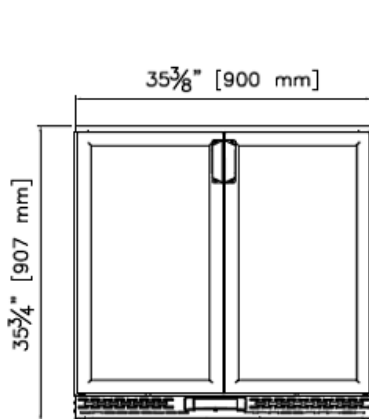

IMD-ERV25GD

Review:03 Date: 11/02/2023 IMD-ERV15_25_35_GD

ETL LISTED TO UL471 STANDARD AND SANITATION CLASSIFIED TO NSF7 – WE RESERVE THE RIGHT TO CHANGE SPECIFICATIONS WITHOUT PRIOR NOTICE

