

Vinotemp®

A PROUD HERITAGE OF EXPERIENCE & QUALITY



**4 BOTTLE WINE
DISPENSERS**
DISPENSER & PRESERVER
VT-PRWINEDIS4S & VT-WINEDISP4

OWNER'S MANUAL

Vinotemp

WWW.VINOTEMP.COM



A Proud Heritage of Experience & Quality

PRODUCT REGISTRATION

Purchase Confirmation

With the information you provide, we can confirm the date of purchase for your product. The confirmation is of benefit to you, especially if your original proof of purchase is lost.

Product Registration

Completing this product registration is the only way to guarantee you will be notified of substantive issues that arise concerning your product.

Become a Member of the Vinotemp® Family

Complete this product registration with your e-mail address and receive special offers and updates on new products via e-mail.

IMPORTANT:

Complete your product registration today!

Visit product and warranty registration at:

<https://www.vinotemp.com/extended-warranty/register-warranty>

For more information on warranty service and repair, please refer to the appropriate section of your product literature.

For additional information about Vinotemp products, visit www.vinotemp.com or call toll-free 1-800-777-8466

Please also fill out the Questionnaire below for a chance to receive a FREE GIFT.

<https://www.vinotemp.com/product-registration-form>

For more information on Prop 65, go to:

<https://www.vinotemp.com/prop65>

YOUR WINE DISPENSER

This wine dispenser can be used for storage and/or service. The unit has a glass door and a soft interior light to elegantly display your wine.

SERVING WINES

Storing wines at the proper temperature is important. To preserve them as long as possible, wine should be stored at approximately 55°Fahrenheit. However, the chart below suggests the optimal drinking temperature for the different styles of wine.

°C	°F	Wine Style
19	66	Armagnac, Brandy, Cognac
18	64	Full Bodied Red wines, Shiraz
17	62	Tawny Port
15	59	Medium Bodied Red Wines
14	57	Amontillado Sherry
13	55	Light Bodied Red Wines
12	54	Full Bodied White Wines
11	52	Medium Bodied White Wines
10	50	Rose Light Bodied White Wines
9	48	Vintage Sparkling
8	46	Fino Sherry
7	45	Non Vintage Sparkling

General Operating Instructions

Remove all external and internal packaging from your appliance. Be sure that all parts have been included before discarding any packaging materials. You may want to keep the box and packing materials for use at a later date.

Upon receipt and inspection of unit, the supply cord must be replaced if it is damaged. Contact our customer service at 1-800-777-8466 or info@vinotemp.com.

NOTE: Before connecting your wine dispenser to the power source, let the unit stand upright for 24 hours. This will reduce the possibility of a malfunction in the cooling system from handling during transportation.

READ ALL INSTRUCTIONS BEFORE USING THIS APPLIANCE
- Save these instructions!

To register your product, visit: <http://www.vinotemp.com>
Register your warranty within 10 days of receiving the unit.
Please be sure to retain your proof of purchase.

TABLE OF CONTENTS

IMPORTANT SAFETY INSTRUCTIONS	6
ELECTRICAL CONNECTION	7
PARTS AND SPECIFICATIONS.....	8
INSTALLATION INSTRUCTIONS	9
OPERATING YOUR WINE DISPENSER.....	9
CARE AND MAINTENANCE	11
CIRCUIT DIAGRAM	12
PROBLEMS WITH YOUR WINE DISPENSER	13
TERMS OF SALE AND WARRANTY	15
SERVICE & IMPORTANT NOTICE	20

IMPORTANT SAFETY INSTRUCTIONS



To reduce the risk of fire, electrical shock or injury when using your appliance, follow these basic precautions:

- Read and follow all instructions before use.
- Do not operate this or any other appliance with a damaged cord.
- Always unplug the appliance before performing any care or maintenance.
- Exercise caution and use reasonable supervision when appliance is used near children. Never allow children to operate, play with or crawl inside the appliance. Keep packing materials away from children.
- Do not clean appliance with flammable fluids. Do not store or use gasoline or other flammable vapors and liquids in the vicinity of this or any other appliance. The fumes can create a fire hazard or explosion.
- To clean, only use mild detergents or glass cleaning products. Do not use solvent-based cleaning agents or abrasives.
- Do not operate with housing panels removed or damaged.
- When disposing of refrigerated appliances, special handling is often required. It is the consumer's responsibility to comply with federal and local regulations when disposing of this product.
- Do not attempt to repair or replace any part of your appliance unless it is specifically recommended in this manual. All other servicing should be referred to a qualified technician.
- Locate the unit away from direct sunlight and sources of heat (stove, heater, radiator, etc).
- Do not use this appliance for other than its intended purpose.
- Do not store food in cabinet.
- Do not place any other appliance on top of the unit.
- For adult use only.
- Do not lift or carry the wine dispenser by the cord.
- Do not plug in to the power socket before setup is complete.
- When positioned or if moving the appliance, ensure that it is not set horizontally, positioned at an angle of more than 45°, or turned upside down.
- Place the appliance on a solid, level surface. Allow for proper clearances on all sides of the unit.
- The wine dispenser is an electrical appliance. To avoid injury or death from electrical shock, do not operate the unit with wet hands, while standing on a wet surface or while standing in water.
- Allow unit to stand upright for 24 hours prior to first plugging it in.
- This unit is designed for indoor, household use only. Any other use will void the warranty.

WARNING: Risk of child entrapment and suffocation. Before you throw away this or an old unit, take off the door. Leave the shelves in place, so that children may not easily climb inside.

WARNING: Gas bottle contents under pressure. Do not puncture or incinerate. Keep away from heat and out of direct sunlight. Keep away from sharp objects that could puncture chamber. Do not store in an enclosed vehicle. Do not discharge towards face or body. **KEEP OUT OF REACH OF CHILDREN.**

ELECTRICAL CONNECTION

WARNING



ELECTRIC SHOCK HAZARD

Disconnect electric supply from appliance before servicing.
Replace all panels before operating.
Failure to do so could result in death or electrical shock.

To avoid the risk of electrical shock, property damage, personal injury or death:

- The power cord must be plugged into a 3-prong grounding -type wall receptacle, grounded in accordance with the National Electrical Code, ANSI/NFPA 70 - latest edition and local codes and ordinances.
- It is the personal responsibility of the consumer to have the proper 3-prong wall receptacle installed by a qualified electrician.
- **DO NOT, UNDER ANY CIRCUMSTANCE, REMOVE THE POWER CORD GROUNDING PRONG.**
- A separate adequately fused and grounded circuit should be available for this appliance
- Do not remove any grounding wires from individual components while servicing, unless the component is to be removed and replaced. It is extremely important to replace all grounding wires when components are replaced.

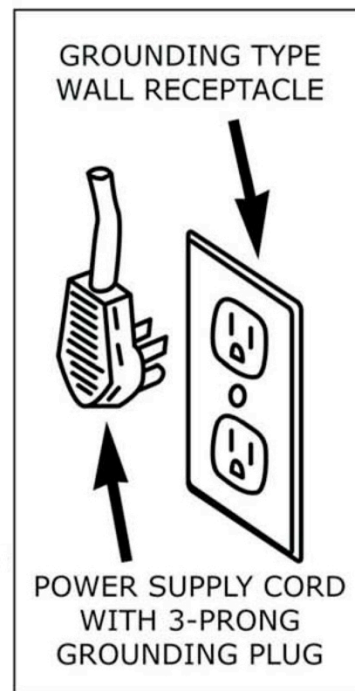

- **DO NOT USE A GROUND FAULT INTERRUPTER (GFI)**
- **A DEDICATED 15 AMP CIRCUIT IS HIGHLY RECOMMENDED**

Electrical Cord

We strongly recommend against the use of an extension cord. However, if you still elect to use an extension cord, it is necessary that it be a properly rated UL-listed, 3-wire grounding type appliance extension cord with a 3-blade grounding plug and a 3-slot receptacle.

PARTS AND SPECIFICATIONS

This refrigerated wine dispenser displays, stores, and dispenses 4 opened wine bottles, keeping them fresh from oxidation for up to 45 days. Wines can be maintained at a chosen storage and serving temperature between 45°F and 65°F. Plastic components, sanitary stainless steel spouts and electronic valves keep wines clean and prevent any drips from spouts. Easily dispense a perfect glass of wine at any time with just the touch of a button.

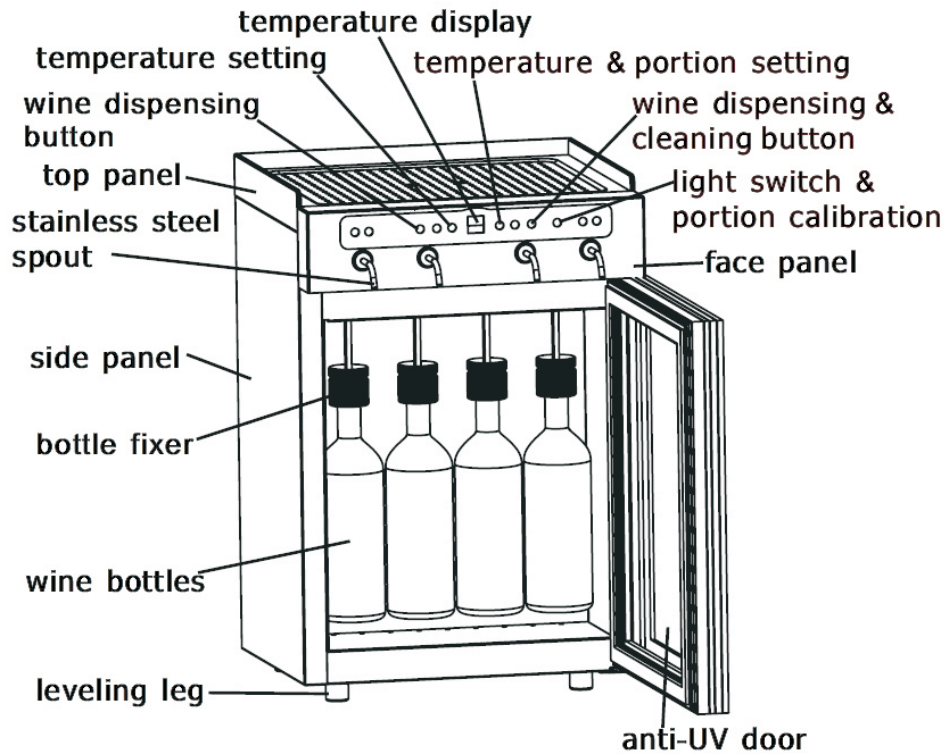

Model No.	VT-PRWINEDIS4S	VT-WINEDISP4
Voltage	AC 120V	AC 120V
Frequency	60 Hz	60 Hz
Cooling Power	95W	95W
Refrigerant	R600a	R600a
Ar/N ₂ Max Air Pressure	15 PSI	15 PSI
Ar/N ₂ Min Air Pressure	5 PSI	5 PSI
Protection Class	I	I
Power Consumption	0.7 kWh/24h	0.8 kWh/24h
Adjustable Temp. Range	45°-65°F (7°-18°C)	45°-65°F (7°-18°C)
Ambient Temp. Range	46°-90°F (7°-32°C)	46°-90°F (7°-32°C)
Bottle Capacity	4	4
Maximum Bottle Shelf Life	45 days	45 days
Approx. Dimensions (WxDxH)	16.35"x17.45"x24.55"	16.35"x17.45"x24.55"

Note: Argon and Nitrogen gas cartridges (gas weight of approximately 14 grams) are not included. Suitable standard gas cartridges are non-refillable and have a threaded neck size of 1/2"20 and minimum length of 13mm. The cartridge must have a diameter not exceeding 45mm and a length not to exceed 140mm.

INSTALLATION INSTRUCTIONS

BEFORE USING YOUR UNIT

- Remove all packing material before using your wine dispenser. Check to be sure the appliance is in good condition.
- Use a soft, dry cloth to wipe down the outside of the wine dispenser thoroughly.
- Before connecting your wine dispenser to the power source, let the unit stand upright for 24 hours. This will reduce the possibility of a malfunction in the cooling system from handling during transportation

LOCATING YOUR UNIT

- This wine preserver-dispenser is designed for freestanding installation only.
- It is recommended that this unit be kept in a location with an ambient temperature range of 45°F-90°F. Not intended for garage or basement installation.
- Place your wine dispenser on a solid, level surface (other than carpet). This will ensure vibration and noise-free operation. Use the adjustable legs to ensure that the unit is level.
- Leave a 5 inch clearance on all sides of the unit. This is to ensure proper air circulation.

OPERATING YOUR WINE DISPENSER

LOADING & UNLOADING ARGON/NITROGEN/INERT GAS BOTTLE

1. Press and hold the wine dispensing button  to empty the remaining gas in the cartridge.
2. Unplug the unit.
3. Rotate the cover upwards to access the gas cartridge.
4. Pull the cartridge out of the unit and turn it counter-clockwise to loosen.
5. Place a new cartridge and align it to the neck thread of the regulator. To properly position the cartridge, rotate once clockwise, and once aligned continue to turn clockwise to tighten.
6. Push the cartridge back into the dispenser and close the cover.

Note: It is normal that a little gas escapes when the gas cartridge is being tightened to the regulator.

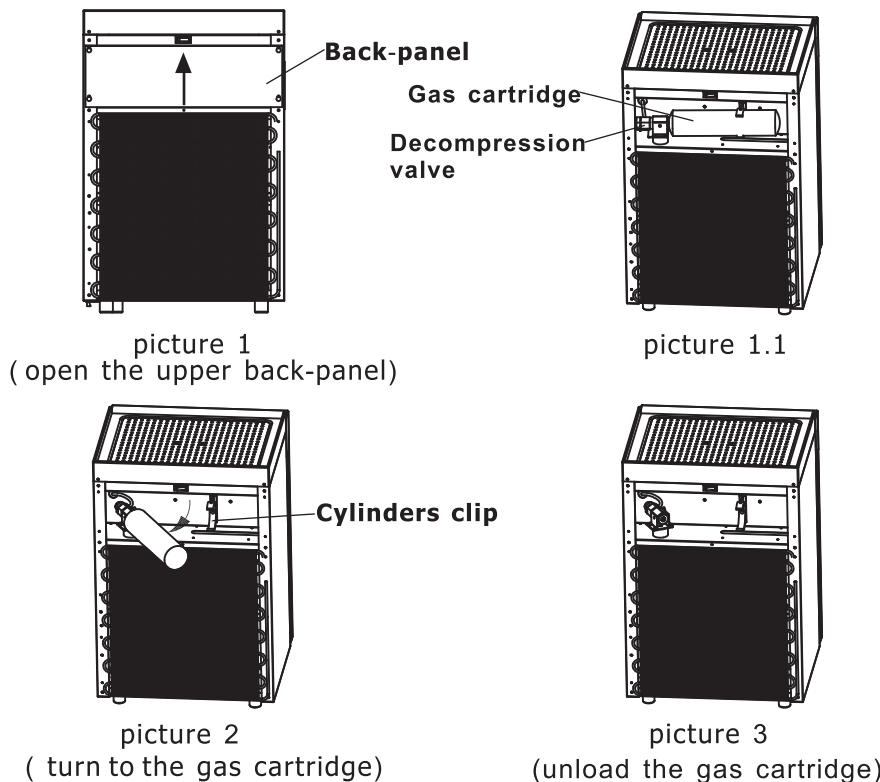

ATTACHING & REMOVING WINE BOTTLES

1. Unscrew lower part of bottle fix nut and place it on the neck of desired wine bottle.
2. Slide bottle upward, with gas and wine tube inside the bottle.
3. Fit bottle mouth into silicon plug. If bottle mouth is larger, lift upper part of bottle fix nut to free silicon plug completely and ease bottle mouth into the silicon plug first.
4. Tighten lower part of bottle fix nut to the upper part.
5. Press the dispensing button to allow wine out and check to see if gas leakage will occur. (Reconnect tighter if needed so gas does not escape.)
6. Place wine fully in refrigerated cabinet and close door.

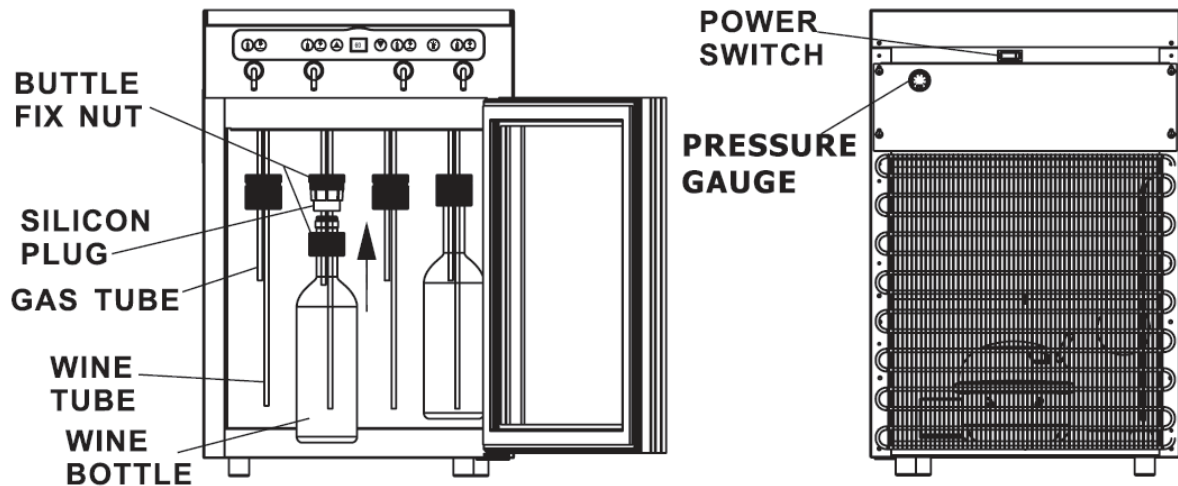

Once the wine dispenser is positioned and plugged in, turn the power on.

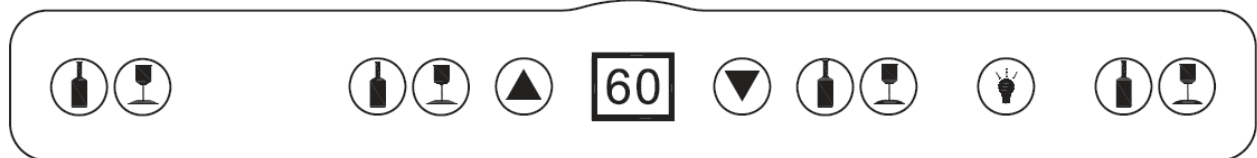



DISPENSING WINE

The wine dispenser features two sets of two dispensing buttons, each positioned directly above its corresponding wine bottle spout. The two dispensing button options are:

- Press and hold the button over the desired spout to begin dispensing wine into your glass. Wine will continue to be dispensed until the button is released.
- Press the button to dispense wine in 1oz increments. Press it once to dispense 1oz, twice to dispense 2oz, and so forth.
- *Resetting the 1 oz. portion control setting:* The 1 oz. preset portion control setting can be reset by the user. To set the portion control, press and hold the button until the display shows "H2" and the previously set portion amount begins to flash. Using the or buttons, you can increase or decrease the portion control settings in 1 oz. increments until you reach your desired setting.
- *Calibrating the portion:* If the amount of wine dispensed varies, additional calibration may be used to correct the dispensed portion of wine. To calibrate the portion control setting, press and hold the button until the display shows "H3" and the previously set portion control amount begins to flash. Using the or buttons, you can increase or decrease the portion control settings if necessary. Once you have checked the portion control setting, press the button to dispense wine and verify the amount poured. **Note:** You may need to repeat this procedure several times until the correct portion is dispensed.

SETTING THE TEMPERATURE

The temperature display will show the current temperature inside the unit. To set a temperature, press and hold the  button till the display shows "H1" and the displayed temperature starts to flash. Once the temperature display starts to flash, use the  or  buttons to select your desired temperature.

For your wine to stay fresh up to 45 days, wine bottles must be closed and the unit preservation system must be properly sealed to prevent deterioration. Keep wine at proper temperature in unit.

LED Light



The LED light can be switched on or off by pressing the  button.

CARE AND MAINTENANCE

IMPORTANT: Always unplug your wine dispenser before cleaning or performing maintenance. Never use harsh cleansers or scouring pads to clean any part of the wine dispenser.

CLEANING

To clean the stopper dispenser and solenoid valve:

1. Fill a bottle with clean warm water and place the stopper-dispenser onto the bottle.
2. Press and hold the  button to begin dispensing the warm water.
3. To start the automatic cleaning setting, press the portion  button 5 times and then hold until the display begins to flash and shows "CL".
4. Continue to dispense and flush the system until dry argon comes from the spout.

CIRCUIT DIAGRAM

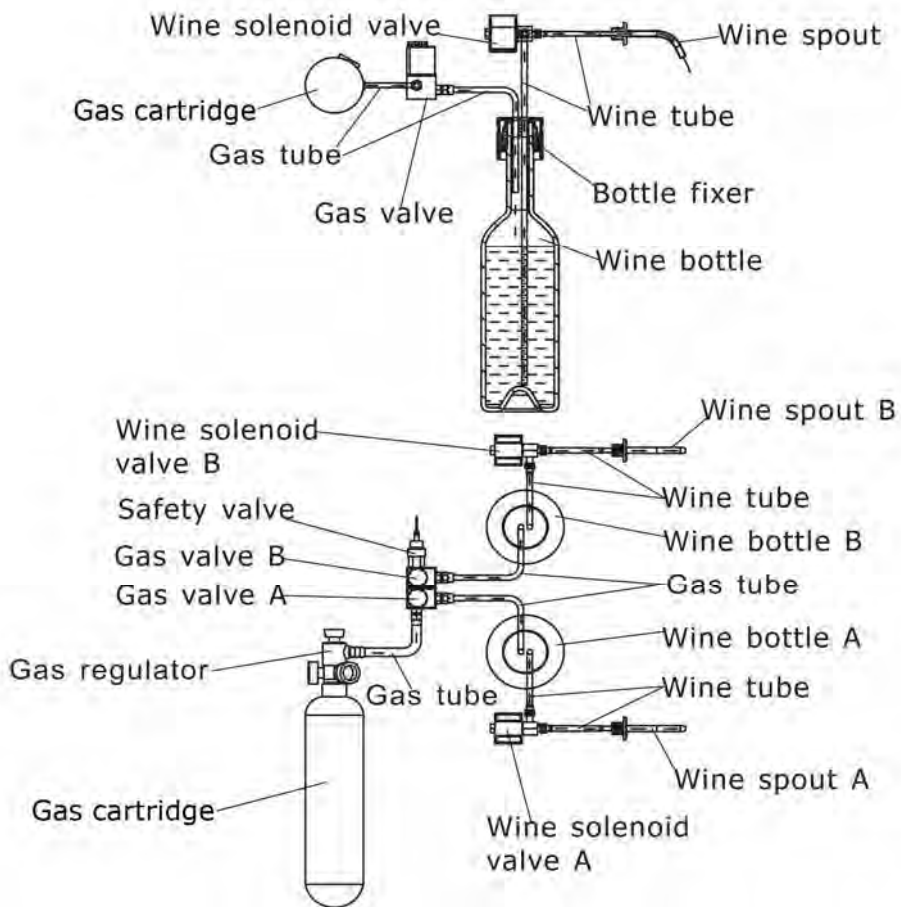
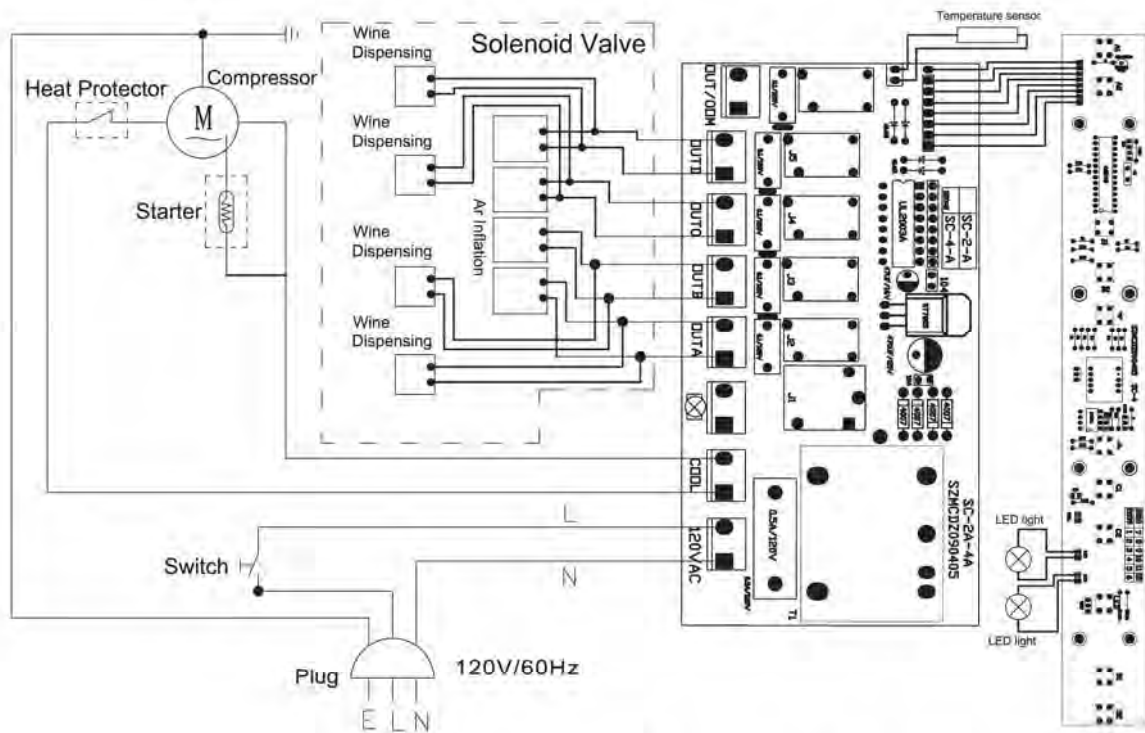

PROBLEMS WITH YOUR WINE DISPENSER

Most common problems can be solved easily, saving you the cost of a possible service call. Try the suggestions below to solve the problem before contacting Vinotemp at info@vinotemp.com.

TROUBLESHOOTING

Dispensing System

Complaint	Possible Causes	Response
One canister only dispensing 1 or 2 bottles, gas leaking/escaping	<ul style="list-style-type: none"> a. Canister gasket unaligned, bad or missing b. Canister not tightened c. Gas tube broken d. Gas tube not tightened at the regulator or valve e. Regulator leak f. Gas valve stuck open g. Bottle not tightened 	<ul style="list-style-type: none"> a. Align, change or install the gasket b. Turn the canister clockwise all the way c. Change the gas tube d. Check for these connections e. Check for gas escaping at the regulator f. If gas continues to escape from the gas tube, check for gas valve and wirings g. Check the plug/fixer
Unit not dispensing	<ul style="list-style-type: none"> a. Argon/Nitrogen leak b. Defective pressure regulator c. Bottle neck not tightened or defective plug d. Defective gas solenoid valve or incorrect wiring e. Defective wine solenoid valve or incorrect wiring f. Incorrect or loose wirings, defective power board or control board 	<ul style="list-style-type: none"> a. If none of the spouts dispense wine, check for canister pressure gauge or turn the canister slightly counter clockwise to see if any gas escapes (turn clockwise to re-tighten), then check for gas leaking as instructed above b. If none of the spouts dispense wine and the canister has pressurized gas, check the regulator c. Press dispense button to check if gas is escaping from the plug or fixer d. Press the dispense button to see if gas is escaping out of the gas tube e. Switch the questionable valve to a working spout and check to see if problem still exists f. Check all wirings and connections
Dispensing interrupted or slow	<ul style="list-style-type: none"> a. Argon/Nitrogen low b. Gas tubes kinked or twisted c. Bottle neck not tightened d. Gas solenoid valve restricted e. Wine solenoid valve restricted 	<ul style="list-style-type: none"> a. If all spouts are dispensing wine slowly, check the gas pressure and install a new canister if necessary b. Press dispensing button to see if gas is escaping out of the gas tube slowly c. Check the bottle plug and fixer for escaping gas d. Remove bottle, press dispensing button to see if gas is escaping out of the gas tube e. Switch to a working spout to check
Wine spurting or spitting	<ul style="list-style-type: none"> a. Wine tube is restricted b. Bottle is near empty and there is too much gas in the bottle c. Gas pressure is too high d. Wine solenoid valve is dirty 	<ul style="list-style-type: none"> a. Check for any restrictions b. Change the empty wine bottle out for a full one c. Replace the pressure regulator d. Clean solenoid valves

Dispensing System

Complaint	Possible Causes	Response
Wine dripping	a. Solenoid valve seal leak b. Spout loose	a. Check for debris if constant dripping; use warm water to flush the system b. Push the spout to tighten if there is intermittent dripping
	a. Wine tube leak b. Spout loose c. Empty bottle	a. Check the wine tube b. Push the spout to tighten c. Change the empty bottle out for a full bottle
Wine divided	a. Debris in spout	a. Clean out debris
Too many bubbles	a. Argon/Nitrogen pressure is too high	a. Replace the pressure regulator

Cooling system

Complaint	Possible Causes	Response
Unit not running	a. Power cord unplugged b. Power switch off c. No power to the outlet d. Incorrect and loose wirings	a. Check the power cord b. Turn the switch on (it will light up when power is on) c. Check for power at the outlet and fuse d. Check the wirings and connections at the power switch and power board
Unit running high temperature or continually	a. Improper door seal b. Ambient temperature is too high c. Improper condenser air flow d. Refrigeration system problems	a. Check the door opening and gasket b. Check the installation location c. Check the fan and clearance d. Call customer service
Temperature is too high	a. Temperature setting is too high b. Displayed temperature is correct but inside temperature is high	a. Lower temperature setting b. Temperature sensor is touching the cold panel
Temperature is too low	a. Temperature sensor is faulty b. Unit is iced c. Power board is faulty d. Display/Control board is faulty	a. Insert the sensor in a cup of iced water to see if it displays 32°F b. Unplug unit to defrost c. Change the power board d. Change the display/control board
Compressor running but not cooling	a. Poor evaporator air flow b. Faulty evaporator fan c. Refrigerant leakage d. Refrigeration system restricted	a. Check for any restrictions b. Check to see if the fan is turning c. Call service technician to check for loss of refrigerant d. Call service technician to check for restrictions
Noisy operation	a. Installation area not firm b. Screws, nuts, and metal parts may be loose c. Fan blade is hitting other parts d. Fan is faulty e. Compressor is faulty	a. Make sure unit is level and on flat, solid surface b. Check to see if the noise is coming from the fan mount, compressor mount or loose tubing c. Check the blade clearance d. Check to see if the fan blade is broken or if the motor is making noise e. Call customer service

Terms & Conditions

Cancellation or Fees Terms:

Shipping/Delivery fees are the responsibility of the Purchaser. Seller is not responsible for the carrier's missed/Non delivery for any reason. Delivery is curbside. Optional upgrades in delivery service is an additional fee. If upgraded delivery service cannot be performed properly, Purchaser agrees to accept delivery curbside and the difference in upgraded cost will not be refunded. If item with free shipping/freight is canceled in transit, a charge of 25% of the price of the unit/s plus freight costs both ways will be charged. All damages must be noted at time of delivery on BOL and Seller to be notified within 48 hours of delivery of such damage. Purchaser acknowledges if cancellation is authorized by Seller, a 35% restocking fee and freight both ways will be charged. No cancellation or refund on made-to-order products. If an order has been placed and production has not started, cancellation fee of 15% of total amount will be charged. Cancelled orders paid by Credit Card will have an additional fee of 3% deducted from the total refund. Once your order has shipped, the shipping address cannot be changed. Refurbished units are sold as is. Purchaser assumes risks to the quality and performance of goods and assumes the costs of all necessary service or repair not covered herein.

(Box here for check mark) Accept Terms & Conditions

Vinotemp International Corp. ("Seller") and the person or entity that acquires these goods from Seller ("Purchaser") hereby fully agrees to the following terms and conditions of the sale: Shipping/Delivery fees are the responsibility of the Purchaser whether freight prepaid or freight collect. Seller assumes responsibility for the goods sold to the Purchaser until the goods have reached Purchaser's delivery address (FOB Destination) and the delivery receipt is signed clear. Seller is not responsible for the carrier's late delivery, missed delivery, unpaved roads, remote locations, stairs, elevators, narrow door openings and other such issues in attempting to fit or deliver the goods into the Purchaser's location. Delivery to remote locations may require additional fees. Remote location may be defined at the discretion of the carrier as more or less than 50 miles from the nearest major city. Purchaser assumes all responsibility for additional costs related to freight such as access, measurement, installation, hookup, wiring, moving and storage of the goods, flight of stairs, carrier's inability to safely and/or adequately deliver, inability to use the building elevator to lift the goods, narrow openings, along with any additional costs to deliver or redeliver the product properly. Make sure to review access to the property and size of the product ordered.

The transportation of all goods is subject to the terms and conditions which the carrier imposes on Purchaser. Installation is the responsibility of the Purchaser. If white glove delivery was ordered and cannot be performed properly, or access is hindered in any way, Purchaser agrees to accept delivery curbside (delivery service cannot be refunded). If Purchaser will-calls or pays for their own freight responsibility transfers to the Purchaser when the Purchaser or Purchasers freight company picks up the unit from Seller. Freight quoted are either curbside, threshold or white glove. Standard white glove delivery is main floor, easy access and NO STAIRS, Doors, aligned feet attached (if necessary) and removal of packaging, additional fees for additional requests. Each service has a different rate and will require additional fees. If freight is not charged (Free Shipping or Freight Included) and the order is cancelled after shipping, a freight charge of 25% of the cost of the unit, each direction will be charged. Item swap outs are arranged as curbside delivery and pickup unless noted otherwise. There is no white glove service for returns. Approved returns must have original and/or proper packaging. Swap-outs (Delivery and Pick up are at the same time) Original unit must be packed and ready for carrier pick up at time of delivery of new unit. Packaging of old unit must be adequate for shipping, not oversized or on a pallet if unit was not originally delivered on a pallet. Carrier will not drop off new unit if the original unit is not ready. If the carrier has to make a second attempt, customer will be subject to additional charges for the attempted delivery and for any packaging issues. Deliveries include ONE attempt by the shipping company to deliver the product to the consumer. If for any reason the customer is unavailable to accept the order and the product is undeliverable under any circumstances, the customer will be responsible for any extra shipping and handling charges. We are a manufacturer not a shipping company, deliveries are done by a 3rd party service. Email us at info@vinotemp.com for a quote or any additional information. Freight discussed is Continental USA (excluding Alaska, Puerto Rico, Hawaii), cost is additional please email info@vinotemp.com for a quote.

If you use a service repair company without approval or parts not supplied by Vinotemp and your unit under warranty fails to work, we will repair your item provided you ship your unit prepaid to and from our facility in Henderson. Vinotemp is not responsible for install or removal costs or unauthorized repairs. If the repair or unauthorized part damaged the unit, we will provide customer a cost to repair that damage.

California Proposition 65 Warning: The products sold on this ecommerce website and to the public may contain chemicals and other substances known to the State of California to cause cancer and birth defects and other reproductive harm.

Totes made of vinyl, imitation leather, and/or leather material contain lead and/or other substances that are known to the State of California to cause cancer, birth defects and other reproductive harm.

Microfiber "Plastic microfiber" means a small synthetic particle that is fibrous in shape, less than 5 millimeters in length, and is released into water through the regular washing of textiles made from synthetic material.

Composite wood: May contain formaldehyde.

Galvanized metal and some of its constituents contain lead and/or other substances that are known to the State of California to cause cancer, birth defects and other reproductive harm.

Products made of vinyl contain lead, Diethyl Hexyl Phthalate (DEHP), and/or other substances that are known to the State of California to cause cancer, birth defects and other reproductive harm.

Acrylic may contain Acrylic Acid and/or other substances that are known to the State of California to cause cancer, birth defects, and other reproductive harm.

Appliances may contain tin or lead in either the paint or the controllers, and/or other substances that are known to the State of California to cause cancer, birth defects, and other reproductive harm.

Our barware items may contain plastic, acrylic, enamel, crystal, metal and/or other substances that are known to the State of California to cause cancer, birth defects, and other reproductive harm.

Appliances may contain Tin, Lead or Nickel

Damage: All damages must be noted at time of delivery. If a bill is signed that there is no damage, buyer accepts delivery as free and clear. Any claim for damages of the goods, when FOB Destination, that incurred during shipment by the carrier are insured and handled directly with the carrier by the Seller if noted on the receipt and notified within 48 hours of delivery. **OPEN AND INSPECT YOUR DELIVERY.** When FOB Destination, if the item is damaged by the freight company, and Purchaser cancels rather than accepts a replacement, the order can be cancelled by paying for freight costs both ways and a 35% restocking fee for stocked items. No cancellation or refunds on custom/made or made to order products. When shipped 3rd Party (FOB Warehouse), Purchaser assumes all responsibility for delivery, payment of freight and freight claims for damages during shipment. Manufacture defects will be handled directly with Seller, subject to the limited warranty below.

Fees: All sales are final. Unless authorized in writing by the Seller, Purchaser may not return the goods under any circumstance. If Seller agrees in writing to take back stocked goods, there will be a restocking/service fee that is 35% of the purchase price of the goods and freight both ways (product must be new, unused, and in original packaging). If Purchaser returns goods claiming that the goods are defective and goods are found to be in working condition by the Seller, Purchaser is liable for the cost of freight both ways plus and a service fee that is 35% of the purchase price of the goods. Built to Order and Custom products are nonreturnable, nonrefundable. Purchaser must notify Seller of nonconforming goods within 48 hours of receipt, after which time all goods are deemed accepted by the Purchaser. If an order has been placed and production has not started, cancellation of your order will be a 15% charge. If Purchaser tenders payment with a check that has insufficient funds (NSF), a collection fee plus NSF fee of \$50 will be added to the invoice, which Purchaser agrees to pay promptly. If Purchaser puts a stop payment on a check or credit card for any reason, Purchaser agrees to pay for all costs associated with the Seller's collection or litigation of such a claim, including, without limitation, general and special damages, court costs and attorneys' fees. Finance charges begin the date of invoice. Title to the goods reverts back to the Seller in the case of nonpayment of goods or services. All fees and costs to retrieve the product, cost of freight, legal costs, collection fees and court fees, credit card fees and interest rate of 18% (annual rate) will be the responsibility of the Purchaser. In a credit card dispute, Purchaser assumes and must immediately pay any "credit card arbitration" fees and chargeback fees which the credit card companies charge at the time of the chargeback. Cancelled orders using a Credit Card will have an additional fee of 3% deducted from the refund.

Any disputes not resolved within 30 days from the invoice date will be reported to credit reporting agencies.

LIMITED WARRANTY: Seller warrants that the goods will be free of defects in materials and workmanship as follows:

Furniture style (wood) wine cabinets made in the U.S.: all cooling unit parts only for a period of 1 (year) year; cabinetry and labor (uninstalled) for a period of 12 (twelve) Months (Model numbers "Vino" and "Custom").

Metal cabinet units (appliances) (compressor) (made in China and Denmark)(Model numbers start with EL, VT, IL, or EP: parts and labor for cooling system and cabinetry for a period of 12 (twelve) months.

Thermoelectric Units: 90 (ninety) days (including Wine and Beverage Coolers, Beer Dispensers, Humidor, Portofino Wood Cellars, and Refrigerators). (Models start with EL, VT, IL or EP).

WineMate and Cellar Tec (WM, Wine Mate or CT)(Wine Cooling Units) Split and Ducted Systems and other installed cooling units are parts only for 1 year, no labor. Self Contained WineMate Cooling Systems are 1 year parts, 1 year labor. Removal and reinstallation of cooling units is not included.

Wine Accessories, Racking Systems, Parts and Other miscellaneous items is a 30 day warranty.

Il Romanzo units: Warranty 90 (ninety) days. Replacement part 12 (twelve) months from the date of sale.

Brama: 1 year warranty from date of purchase.

Non-New Units (Scratch & Dent/Refurbished/Floor Models), warranty for compressor units is 90 days from your dated invoice and 30 days for thermoelectric units (parts for function only, not cosmetic defects). These units are refurbished and sold as is; Purchaser assumes risks to the quality and performance of goods and assumes the costs of all necessary service or repair not covered herein. Extended warranties via New Leaf may not be purchased on Non-New Units. Delivery is curbside. Upgrades in delivery will require an additional fee.

Element Grills (via Element Products LLC), grills have a thirty day limited parts warranty on grill accessories.

If a model is not listed here will have 90 day warranty on parts only if it's a new item.

Parts and Repairs: Warranty on in-house repairs: 90 days parts and labor for compressor; 30 days parts and labor for Thermoelectric; Customer is required to put down a labor deposit of \$75 for Thermoelectric units; \$150 for compressor based Wine Coolers and \$195 for WineMate units which will be kept if a unit is found to be in good working condition. Customer is responsible for freight costs to us.

Warranty on parts purchased: 30 days; if part fails within 30 days of purchase, customer is to ship us back the part; upon inspection, if defective, VT will send replacement part at no charge.

If a purchaser claims a product is "defective" with regards to refrigeration, Purchaser must obtain a letter from a qualified refrigeration technician at the Purchaser's cost to verify that the unit was installed properly, with proper ventilation and the unit is truly malfunctioning due to a manufacturing defect.

Removal or reinstallation of a unit is not included in warranted costs. Purchaser's exclusive remedy is limited at Seller's option to repair or replace defective part[s] with either new or reconditioned part[s]. Purchaser is responsible for shipping the unit prepaid to a designated facility and Seller will pay return shipping charges in the continental United States for items repaired under warranty within 12 (twelve) months from date of sale. The returned unit must be packaged correctly, with enough protection to ensure the unit is not further damaged. Oversized or lack of packaging is not permitted and will be refused. Replacement or exchanged units will be returned to Purchaser through curbside delivery only. Any redelivery fees are the Purchasers responsibility. Since the natural variation in texture, density, grain, color, tone, and shade of wood is unavoidable; Seller does not guarantee the texture, color, tone, or shade of the wood: nor does seller guarantee the colorfastness of wood or against peeling, chipping, cracking, or scratching. Note: Unfinished wood is subject to warping; all wood surfaces must be sealed before placing cellar into service. Make sure doors are aligned by reviewing the owner's manual. Improper repair or placement of the unit will void the warranty. Any third party repair facility must be preapproved in writing by Seller, before providing replacement parts under warranty. Change Orders: Custom units already in production that require a change will be subject to a change order fee.

Storage Fees: When having an item serviced by a Vinotemp service technician at the Vinotemp facility, Purchaser agrees to pick up their repaired item or make arrangements for return shipping within a 30 day period once they have been notified by Vinotemp through phone call, email, or letter that their unit is ready for pick up. If the item remains in the Vinotemp warehouse after 30 days but no longer than 60 days, the Purchaser will incur additional storage fees of 2%. After 60 days in storage, the item will become property of Vinotemp. For custom units with deposits: If product is not picked up or shipped within 60 days of completion, Purchaser deposit is forfeited and product becomes the property of Vinotemp. Warranty period is from the date of sale (not from shipping, delivery, nor installation).

All completed cabinetry, racking, or other custom work must be picked up or shipped within a period of 14 days after Vinotemp has notified the Purchaser by phone call, email, or letter. Any completed cabinetry, racking, or other custom work stored longer than 14 days will incur an additional monthly storage fee. After 60 days, the product will become property of Vinotemp.

This Limited Warranty does not cover damage due to such things as accident, misuse, abuse, mishandling, neglect, acts of God, fires, earthquakes, floods, high winds, government, war, riot or labor trouble, strikes, lockouts, delay of carrier, unauthorized repair, or any other cause beyond the control of the Seller, whether similar or dissimilar to the foregoing. Seller is not responsible for any damages caused to Purchaser's property resulting from the goods.

This limited warranty applies only inside the Continental US (Alaska, Puerto Rico, Hawaii and other territories/countries are not warranted). Purchaser understands and acknowledges that the goods sold here are wine cellars, cigar humidors, and/or other similar units which house wine or cigars or other items. Purchaser assumes all risk of using these units, including risk of spoilage, humidity variations, temperature variations, leaks, fire, water damage, mold, mildew, dryness and similar and any other perils that might occur. Seller is not responsible for incidental or consequential damages, and there are no warranties, expressed or implied, which extend beyond the Limited Warranty described above. Warranty and liability are nontransferable. The implied warranties of merchantability and of fitness for a particular purpose are hereby expressly disclaimed. Some states do not allow the exclusion of incidental or consequential damages, or a waiver of the implied warranties of fitness and/or merchantability, so the above limitations may not apply to you. This warranty gives you specific legal rights and you may also have other rights which vary from state to state. Seller disclaims any indemnification for claims of infringement of any intellectual property of protectable nature. In the event of any dispute between Seller and Purchaser arising out of or relating to these terms and conditions or to the goods sold generally, Purchaser must first file a written claim with Seller within ten days of the occurrence giving rise to the claim and wait an additional thirty days for a response before initiating any legal action. The sale and all terms are subject to Nevada law. Any legal proceeding arising out of or relating to these terms and conditions or to the goods sold Purchaser shall bring, solely and exclusively in Clark County. In no event may Purchaser initiate any legal proceeding more than six months after the occurrence of the event giving rise to the dispute. Seller may make nonpayment claims until debt is paid in full. Any dispute or claim relating in any way to these to the Terms and Conditions, the Website, or any products or services sold or distributed by or through this Website, store, or catalog will be resolved by binding arbitration, rather than in court, except that you may assert claims in small claims court if your claims qualify. The Federal Arbitration Act and federal arbitration law apply to the Terms and Conditions. We each agree that any dispute resolution proceedings will be conducted only on an individual basis and not in a class, consolidated or representative action. If for any reason a claim proceeds in court rather than in arbitration we each waive any right to a jury trial. Both parties agree to bring suit in court to enjoin infringement or other misuse of intellectual property rights.

The above terms and conditions are the only ones governing this transaction and Seller makes no oral representations of any kind. These Terms and Conditions can only be modified in writing, signed by both Purchaser and Seller.

SPECIFIC WARRANTY BELOW for SCRATCH & DENT/OPEN BOX/ REFURBISHED/FLOOR MODELS/ CLOSEOUTS, OVERSTOCK: TERMS AND CONDITIONS OF SALE

Vinotemp (and its brands Element, Wine Mate, Cellar Tec, Apex Wine Racks, Epicureanist II Romanzo, Brama("Seller") and the person of the entity that acquires these goods from Seller ("Purchaser") hereby fully agree to the following terms and conditions of the sale:

1. Freight: Vinotemp is not a freight, moving or installation company, if Freight is arranged for the Buyer, the Seller assumes no responsibility for the goods sold to the Purchaser once the goods have left the Seller's premises, including, but not limited to, late delivery by the moving carrier, or for events caused by any difficulty carrier incurs in attempting to fit the goods into the Purchaser's place of business or residence due to the size of the goods or otherwise, such as the disassembly and reassembly of the goods. Purchaser assumes all responsibility for delivery, payment of freight, extra fees, access, measurement, installation, hook-up, moving and storage of the goods. The transportation of all goods is subject to the terms and conditions which the moving carrier imposes on Purchaser including, but not limited to, additional charges imposed per flight of stairs, and/or additional charges resulting from the carrier's inability to safely and/or adequately use the building elevator to lift the goods to an upper floor. Any claim for damages incurred during shipment by the carrier of the goods are insured and handled directly with the carrier and must be noted at time of delivery.

2. All sales are final, and unless authorized in writing by the Seller, Purchaser is not entitled to return goods, under any circumstances. If Purchaser refuses to accept goods, the Purchaser is liable for the return and cost of freight both directions and a restocking/service fee that is 35% of the purchase price of the goods. Purchaser must notify Seller of non-conforming goods within four days of delivery, after which time all goods are deemed accepted.
3. If Purchaser tenders payment with a check that has insufficient funds (NSF), or stops payment on a check or credit card for any reason, Purchaser agrees to pay for all costs associated with the Seller's connection or litigation of such a claim, including without limitation extra damages, court costs, collection fees and attorney's fees. Finance charges begin the date of invoice. Collection fees plus NSF fee of \$50 will be added to your invoice, which you agree to promptly pay. Title to the goods does not pass until payment is received in full by Seller and Seller retains a security interest in the goods until they are paid for in full. If the credit card dispute goes to arbitration, Buyer agrees to pay for credit card arbitration fees.
4. LIMITED WARRANTY on Non-New Units (Scratch & Dent/Refurbished and Floor Models): warranty for compressor units is 90 days from your dated invoice and 30 days for thermoelectric units (parts for function only, not cosmetic defects). These units are refurbished and sold as is; Purchaser assumes risks to the quality and performance of goods and assumes the costs of all necessary service or repair not covered herein. Wine Accessories, Racking Systems and other items not mentioned are not warranted. There is no warranty on parts purchased separately. Removal and re-installation of unit is not included in warranted labor. Purchaser's exclusive remedy is limited, at Seller's option; to repair or replace defective part[s] with either new or factory reconditioned part[s]. Purchaser is responsible for shipping the unit pre-paid to designated facility and Seller will pay return shipping charges in the continental United States for items repaired under warranty. Since the natural variation in texture, density, grain, color, tone and shade of wood is unavoidable; Seller does not guarantee the texture, color, tone or shade of the wood: nor does seller guarantee the colorfastness of wood or against peeling, chipping, cracking or scratching. Note: Unfinished wood is subject to warping; all wood surfaces must be sealed before placing cellar into service. Improper placement of the unit will void the warranty. By Vinotemp in writing, any 3rd party repair facility must be pre-approved before providing parts free of charge.
5. Freight: If As-Is unit is shipped including freight and delivery is denied, customer is responsible for freight to and from buyer. Other costs Buyer is responsible for is storage, repackaging, and attempted delivery fees.
6. Vinotemp does not cover damage due to such things as accident, misuse, abuse, mishandling, neglect, acts of God, fires, earthquakes, floods, high winds, government, war, riot or labor trouble, strikes, lockouts, delay of carrier, unauthorized repair, or any other cause beyond the control of the Seller, whether similar or dissimilar to the foregoing. Seller is not responsible for any damages caused to Purchaser's property resulting from the good. This limited warranty applies only inside the Continental US. (Alaska, Puerto Rico and Hawaii are not warranted.)
7. Purchaser understands and acknowledges that the goods sold here are wine coolers, appliances, cigar humidors, and/or other similar units which may house wine or cigars or other consumables. Purchaser assumes all risk of using these units, including risk of spoilage, humidity variations, temperature variations, leaks, fire, water damage, mold, mildew, dryness and similar perils that might occur.
8. UNLESS OTHERWISE PROVIDED BY APPLICABLE LAW, SELLER IS NOT RESPONSIBLE FOR INCIDENTAL OR CONSEQUENTIAL DAMAGES, AND THERE ARE NO WARRANTIES, EXPRESS OR IMPLIED, WHICH EXTEND BEYOND THE DESCRIPTION ON THE FACE HEREOF; WARRANTY AND LIABILITY ARE NON-TRANSFERABLE. THE IMPLIED WARRANTIES OF MERCHANTABILITY AND OF FITNESS FOR A PARTICULAR PURPOSE ARE HEREBY EXPRESSLY DISCLAIMED. SELLER DISCLAIMS ANY INDEMNIFICATION FOR CLAIMS OF INFRINGEMENT OF ANY INTELLECTUAL PROPERTY OF PROTECTABLE NATURE.
9. In the event of any dispute between Seller and Purchaser arising out of or relating to these terms and conditions or to the goods sold generally, Purchaser must first file a written claim with Seller within thirty days of the occurrence giving rise to the claim and wait an additional thirty days for a response before initiating any legal action. Any legal proceeding arising out of or relating to these terms and conditions or to the goods sold generally shall be brought solely in Clark County. The prevailing party in any such proceeding is entitled to its attorney's fees and costs. In no event may Purchaser initiate any legal proceeding more than six months after the occurrence of the event giving rise to the dispute.
10. Delivery is curbside. Upgrades in delivery will require an additional fee.

The above terms and conditions are the only ones governing this transaction and Seller makes no oral representations of any kind. These Terms and Conditions can only be modified in writing, signed by both Purchaser and Seller.
09/30/2020

SERVICE & IMPORTANT NOTICE

Upon receipt and inspection of unit, the supply cord must be replaced if it is damaged. Contact our customer service at 1-800-777-8466 or info@vinotemp.com.

The manufacturer has a policy of continuous improvement on its products and reserves the right to change materials and specifications without notice.

WARNING:

**Please do not place the unit within reach of children.
For adult use only.**

Contact **info@vinotemp.com** with any questions or visit

www.vinotemp.com



Vinotemp[®]

732 South Racetrack Road
Henderson, NV 89015
www.vinotemp.com

Vinotemp is a registered trademark of Vinotemp International. All products, features, and services are subject to change without notice. We cannot guarantee the accuracy of the contents of this document. We disclaim liability for errors, omissions, or future changes.

© 2019 Vinotemp International. All rights reserved.