

REFRIGERATOR MANUFACTURER
Turbo air
 more durable, efficient, beautiful

4184 E. Conant St.
 Long Beach, CA 90808
 Tel. 310-900-1000
 Fax. 310-900-1077
www.turboairinc.com

Project :
 Model # :
 Item # : Qty :
 Available W/H :
 Approval :

Narrow Back Bars

*Underbar Equipment
 Super Deluxe Series*

**Model : TBB-24-60SG-N
 TBB-24-60SB-N6**



TBB-24-60SG-N



TBB-24-60SB-N6

Easy to Clean Air Filter
 Front Access

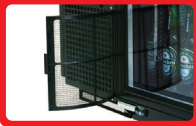

≡ FEATURES & BENEFITS ≡

■ **Self-Cleaning Condenser**

The accumulation of dust in the condenser can cause the failure or breakdown of refrigerators. Refrigerators run normally until they reach a certain level of accumulation. At some point, when they are over the limit, their performance drops quickly resulting in damage to, or disposal of the stored products inside. The Self-Cleaning Condenser device keeps the condenser clean and prevents system failure by automatically brushing daily.

■ **Hydrocarbon refrigerants (R-290 / R-600a)**

With innovative and eco-friendly technology, Turbo Air brings you hydrocarbon refrigerators designed to meet DOE's Energy Conservation Standards in 2017 and to use EPA's SNAP Program approved HC refrigerants. Hydrocarbon refrigerants do not deplete the ozone layer and have very low contribution to global warming (ODP-0, GWP-3).

■ **Ergonomically designed doors**

Customers' fatigue fades away with easy grip handles and doors that open effortlessly. These features along with self-closing doors make this the ultimate choice in customer convenience.

■ **Stainless steel countertop and interior**

The exterior of the cabinet is constructed with heavy gauge reinforced stainless steel countertop and wear-resistant black vinyl coated galvanized steel. The interior is painted galvanized steel with reinforced stainless steel floor. Turbo Air Back Bar model guarantees the utmost in cleanliness and long product life. It also adds a touch of style to the most refined setting.

■ **Forced air cooling system**

Fast cooling and balanced temperature throughout the cabinet.

■ **LED interior lighting**

■ **Double pane glass doors with Low-E glass (SG Models)**

■ **High-density polyurethane insulation**

The entire cabinet structure is foamed-in-place using high density, HCFC free polyurethane insulation.

■ **Adjustable, heavy duty, PE (polyethylene) coated wire shelves**

■ **Side mount compressor unit**

With compressors positioned on the side of the unit, our refrigerators can now be serviced without being moved. Our innovative, front breathing feature also allows this model to be highly efficient in narrow spaces.

■ **Refrigerator holds 33°F ~ 38°F for the best in beverage preservation**

† ENERGY STAR rated models



Model	Swing Doors	CU./FT.	1/2 Barrels	#of Shelves	HP	AMPS	Crated Weight (lbs.)	L x D* x H† (inches)
TBB-24-60SG-N †	2	16.46	2	4	1/3	2.9	307	61 1/8 x 24 1/2 x 35 3/8
TBB-24-60SB-N6	2	16.46	2	4	1/5	2.0	279	61 1/8 x 24 1/2 x 35 3/8

Model : TBB-24-60SG-N/SB-N6

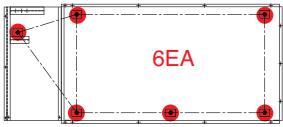
ELECTRICAL DATA		
Voltage	115/60/1	
Plug Type	Ⓜ NEMA 5-15P	
Full Load Amperes	2.9 (SG) / 2.0 (SB)	
Compressor HP	1/3(SG) 1/5(SB)	
Refrigerant	R-290(SG) R-600a(SB)	
Cord Length (ft.)	8.5	
Lamp (W)	9	
DIMENSIONAL DATA		
Capacity	1/2 Barrels	2
	Cubic Feet	16.46
Ext. Length Overall (in.)	61 1/8 (1553mm)	
Ext. Depth Overall (in.)*	24 1/2 (623mm)	
Ext. Height Overall (in.)†	35 3/8 (900mm)	
# of Swing Doors	2	
# of Shelves	4	
Shelf size (L x D) (in.)	22 7/8 x 18	
# of Casters	 6EA	
Net Weight (lbs.)	265(SG) / 236(SB)	
Gross Weight (lbs.)	307(SG) / 279(SB)	

Design and specifications subject to change without notice.

Actual shipping weight may differ due to extra packing materials for product protection.

*Depth does not include 1" for door handle (SG Models).

†Height does not include 2" for rear spacers.

† Height does not include 5" for caster height.

- **WARRANTY : 3 Year Parts and Labor Warranty**
Additional 4 Year Warranty on Compressor

STANDARD FEATURES

- Anti-corrosion coated evaporator
- Self-contained system
- 4" dia. swivel casters standard
- Door locks standard

OPTIONAL ACCESSORIES

- 1" caster, 1/2" diameter & 13 TPI: S28R813660 (non-brake)
- 2" caster for underbar series, 1/2" diameter: P0165B0100 (non-brake), P0165B0110 (w/ brake)
- 2.5" caster: 30265H0100 (non-brake), 30265H0200 (w/ brake)
- 5" caster, 1/2" diameter & 13 TPI: M726500100 (non-brake), M726500200 (w/ brake)
- Leveling leg, 1/2" - 13 TPI x 1.54": LFM1213566
- 6" adjustable stainless steel leg: P0121P0100
- Additional PE coated wire shelf: 30278D1000 (Left), 30278D0900 (Right)

Ver.20200706

PLAN VIEW

(unit : inch)

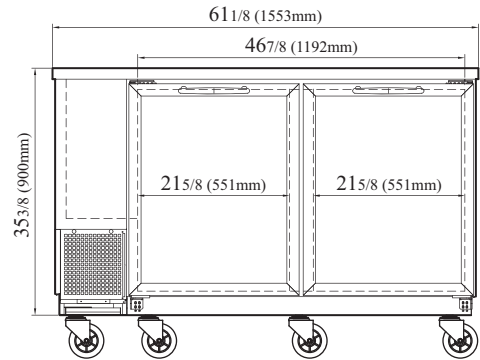

TBB-24-60SG-N FRONT VIEW

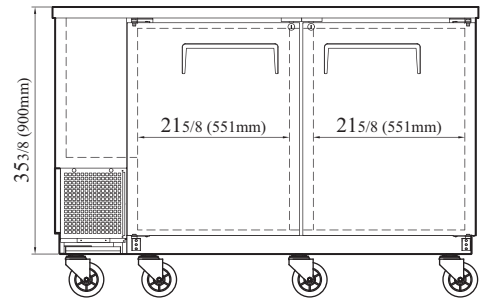

TBB-24-60SB-N6 FRONT VIEW

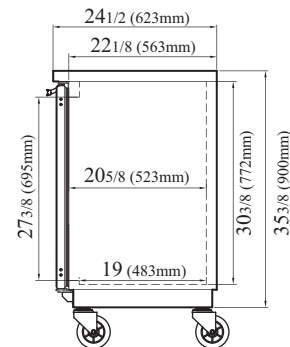

TBB-24-60SG-N SIDE VIEW

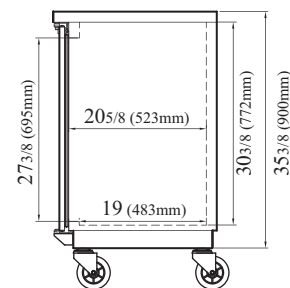

TBB-24-60SB-N6 SIDE VIEW

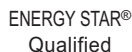

- Turbo Air : 800-627-0032
- GK : 800-500-3519
- Warranty : 800-381-7770
- AC : 888-900-1002

