

## Installation Guide

# MAGMA WALL LIGHT

Thoughtful lighting, responsibly designed in London.

Thank you for making the switch to Tala.

Discover the full Tala family at [tala.co.uk](http://tala.co.uk)

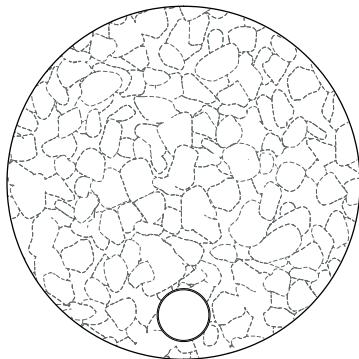

### BEFORE STARTING

Please read instructions thoroughly before installation and keep them for future reference. Please take extreme care when dealing with electrical equipment.

Improper assembly can undermine the safety and longevity of the product.

### IMPORTANT

This light fitting must be connected to the supply earth. If your lighting circuit does not have an earth, ask a qualified electrician to provide an earth facility. This fitting operates on 240V mains voltage.

This product is for indoor use only.

### WARNING

Always switch off electricity supply at the mains during installation and maintenance. We recommend that the fuse is withdrawn or the circuit breaker is switched off whilst work is in progress. Do not just turn off at the wall switch. All fittings must be installed in accordance with current Building Regulations and IEE Wiring Regulations.

### RECOMMENDED EQUIPMENT

- Small flat head screwdriver
- Philips head screwdriver
- Wire strippers

Further equipment may be required for fixing to your wall or ceiling

Please visit our website to see our recommended dimmers.



IP20

220 - 240V~

# Magma Wall Light - Provided Components

- (A) x1 Wall light
- (B) x1 Wall bracket
- (C) x1 End Cap
- (D) x1 Faceplate nut
- (E) x1 Bulb
- (F) x1 Glass
- (G) x1 Junction box
- (H) Wall screws and plugs  
(Always use screws and  
plugs that are appropriate  
to the wall/ceiling)

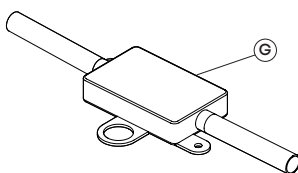
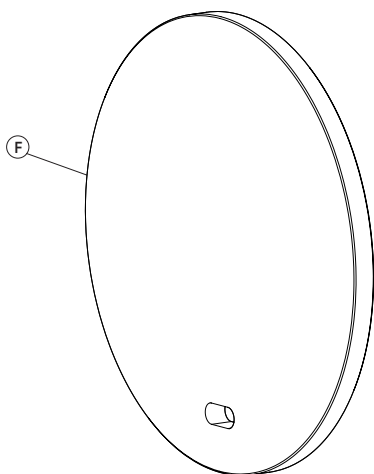
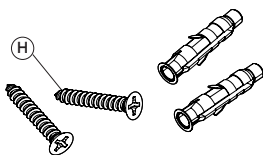
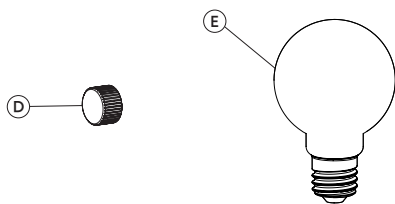
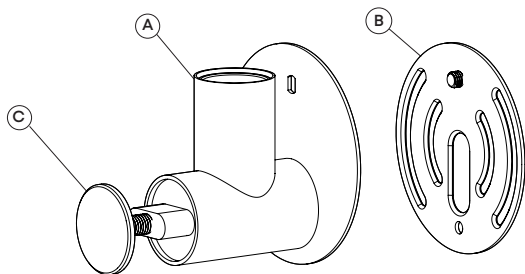

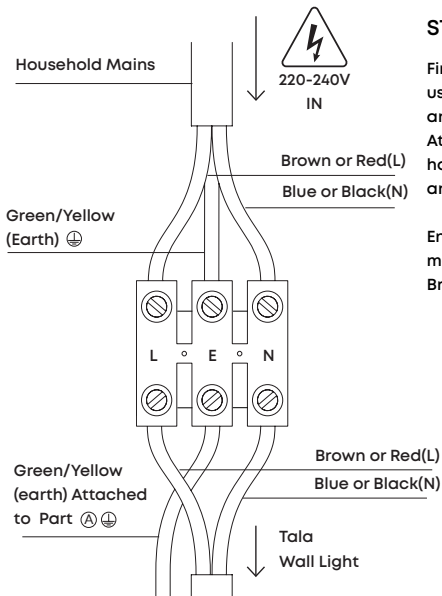

## STEP 1

First identify your household wiring using current Building Regulations and IEE Wiring Regulations. Attach the wall light wiring to your household supply as shown. Use an appropriate junction box.

Ensure all wiring connections are made inside the wall before Wall Bracket (B) is attached.

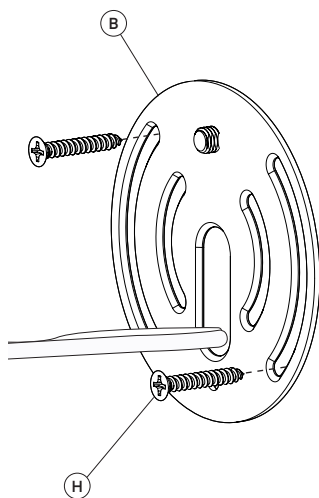

## STEP 2

Attach (B) to your wall using screws and plugs (H) .

Always use screws and plugs that are appropriate to the ceiling/ wall type.

### STEP 3

Align part (A) onto part (B) .  
Secure together with the nut provided (D) .

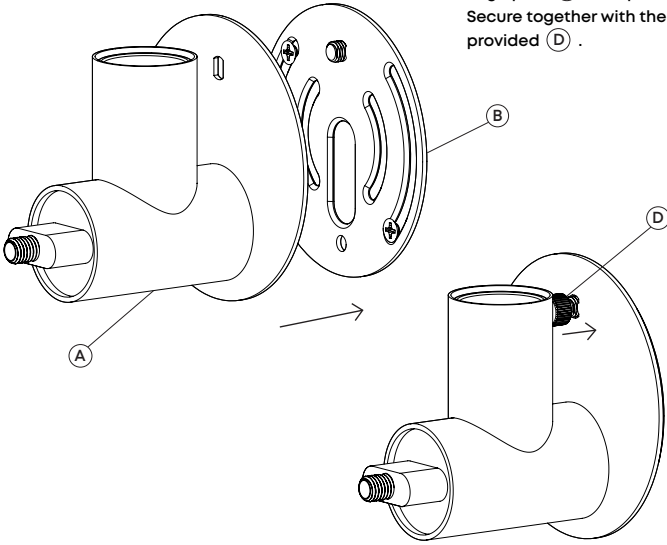

### STEP 4

Insert the bulb (E) into the wall light and rotate clockwise until tight.

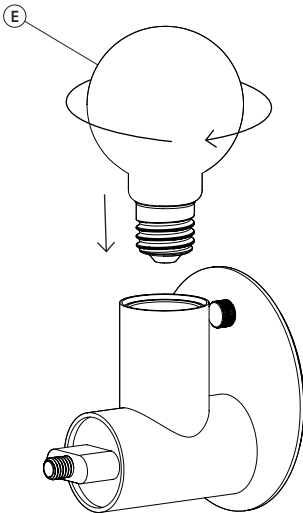

## STEP 5

Position the Glass Disk (F) onto the fixture.

Hand-screw the End Cap (C) onto the fixture tightly to secure the Glass.

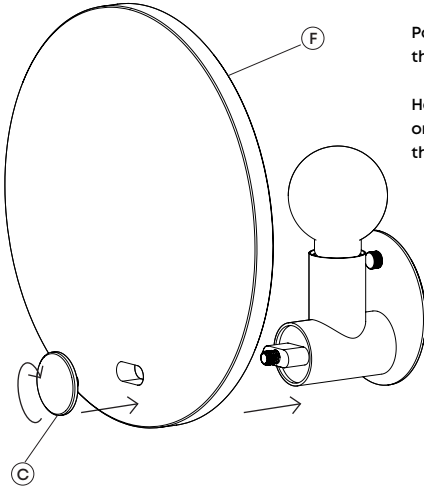

## CARE AND CLEANING

We recommend cleaning with a soft dry cloth.

Do not use abrasive materials as these will damage the finish of the product. Do not use alcohol or other solvents.

## WARRANTY AND AFTER-CARE

This product has a two-year warranty. If there appears to be a functional defect with the product during this time, please contact our team at [customerservice@tala.co.uk](mailto:customerservice@tala.co.uk).

Please note, if the cable attached to this fixture is damaged, it should only be replaced by qualified person.

---

## Join the Community

[hello@tala.co.uk](mailto:hello@tala.co.uk) | Instagram: @tala | Facebook: talaHQ | Pinterest: TalaLED | Tag: lighttoliveby

Tala Studios, 25B Vyner Street, London E2 9DG

Tala Europe B.V, Bertus Aafjeshove 40, Nieuwegein 3437JN, Netherlands